

# AutoVISION Software User Manual



---

Copyright ©2018  
Omron Microscan Systems, Inc.  
Tel: +1.425.226.5700 / 800.762.1149  
Fax: +1.425.226.8250

All rights reserved. The information contained herein is proprietary and is provided solely for the purpose of allowing customers to operate and/or service Omron Microscan-manufactured equipment and is not to be released, reproduced, or used for any other purpose without written permission of Omron Microscan.

Throughout this manual, trademarked names might be used. We state herein that we are using the names to the benefit of the trademark owner, with no intention of infringement.

### **GS1 Solution Partner**



### ***Disclaimer***

The information and specifications described in this manual are subject to change without notice.

### ***Latest Manual Version***

For the latest version of this manual, see the Download Center on our web site at:  
[www.microscan.com](http://www.microscan.com).

### ***Technical Support***

For technical support, e-mail: [helpdesk@microscan.com](mailto:helpdesk@microscan.com).

### ***Warranty***

For current warranty information, see: [www.microscan.com/warranty](http://www.microscan.com/warranty).

### **Omron Microscan Systems, Inc.**

#### **United States Corporate Headquarters**

+1.425.226.5700 / 800.762.1149

#### **United States Northeast Technology Center**

+1.603.598.8400 / 800.468.9503

#### **European Headquarters**

+31.172.423360

#### **Asia Pacific Headquarters**

+65.6846.1214

# Table of Contents

Chapter 1	Quick Start	
	AutoVISION Overview.....	1-2
	Select a Device .....	1-13
	Adjust Camera Settings .....	1-14
	Edit the Job .....	1-15
	Run the Job.....	1-16
	Save the Job .....	1-17
Chapter 2	Connect	
	Launch the AutoVISION User Interface .....	2-2
	Select Device .....	2-3
	Job Changeover.....	2-5
Chapter 3	Image	
	Image Overview .....	3-2
	Image Area.....	3-3
	Image Control Tools.....	3-4
	Auto Calibration.....	3-6
Chapter 4	Edit	
	Edit Overview .....	4-2
	Image Control Tools.....	4-4
	Tools Overview .....	4-6
	Camera .....	4-28
	Locate Tool .....	4-34
	Decode Tool.....	4-37
	OCR Tool .....	4-41
	Count Tool.....	4-55
	Presence/Absence Tool .....	4-60
	Measure Tool .....	4-63
	Match Strings Tool .....	4-82
	String Format Tool .....	4-84
	Logic Tool.....	4-86
	OCV Tool .....	4-90
	Symbol Quality Verification Tool .....	4-93
	Color Tool.....	4-119
	Inspection Outputs .....	4-131
	Omron Microscan Link .....	4-143
	Data Navigator .....	4-148
	Terminal .....	4-152
	Serial Commands.....	4-155

---

*Table of Contents*

Chapter 5	Run	
	Run Overview .....	5-2
	Image Display Options.....	5-3
	Image Saving Options.....	5-4
	Inspection Statistics .....	5-5
Chapter 6	Firmware and License Upgrades	
	Updating Firmware.....	6-2
	Camera License Upgrade .....	6-6
Chapter 7	Example Job – Gasket Inspection	
	Start Gasket Job .....	7-2
	Add Measure Tool.....	7-3
	Add Three Presence/Absence Tools .....	7-4
	Report Gasket Inspection Status and Gasket Height .....	7-5
	Run the Gasket Job .....	7-6

# About AutoVISION Software

Omron Microscan's **AutoVISION** is the easiest-to-use machine vision software available for vision applications of basic to moderate complexity. Process and manufacturing engineers no longer need to become experts in machine vision to successfully deploy a system that meets their traceability, inspection, and quality control needs.

## ***Intuitive User Interface***

AutoVISION features an intuitive user interface that guides users through the steps of connecting to a device, programming a job, and monitoring results. At startup, AutoVISION automatically detects all compatible devices and allows the user immediately to begin configuration. AutoVISION can also be used in an Emulator mode with stored images from a PC. As a device is being configured or while a user is programming a job, AutoVISION provides real-time feedback and results. Because the runtime interface is built into AutoVISION's user interface, at any point in the process a user can try out a job and determine if the device is configured to meet the application's needs.

## ***Complete Tool Set***

AutoVISION's capabilities start with a Locate Tool that is based on pattern matching. The **Locate Tool** can be used to orient other inspection tools or to detect the absence or presence of complex objects. AutoVISION also includes Omron Microscan's powerful X-Mode decode algorithm for **1D and 2D symbol reading** along with fixed font and fully teachable **OCR** for track and trace applications. For inspection and control applications, AutoVISION includes simple yet powerful **Count, Presence/Absence, Measure, Match Strings, String Format, Logic, OCV, Symbol Quality Verification** and **Color** tools.

## ***Scalable with Visionscape***

For applications demanding more flexibility or configuration options, AutoVISION allows users to upgrade to full **Visionscape** functionality while continuing to work with the same camera hardware. AutoVISION jobs (.avp) can be opened with Visionscape, which enables scripting and other advanced programming capabilities. Visionscape can be deployed on both smart camera and PC-based systems.

After AutoVISION is installed, all Visionscape user documentation is located on your local drive in this folder: **Microscan\Vscape\Documentation**.

**Note:** You must have Administrator privileges to install and run AutoVISION and Visionscape.

**Note:** You may see the Windows Security dialog shown below during AutoVISION/Visionscape installation. Click **Install this driver software anyway** to continue installation.



**Install this driver software anyway**

Only install driver software obtained from your manufacturer's website or disc. Unsigned software from other sources may harm your computer or steal information.

# **System Requirements**

AutoVISION 5.0.0 and the supported machine vision systems run on the following 32-bit and 64-bit operating systems:

- Microsoft Windows 7 (32-bit), SP1
- Microsoft Windows 7 (64-bit), SP1
- Microsoft Windows 10 (64-bit)

## ***Minimum PC Requirements***

- Intel® Core™ i3 Processor @1.6GHz
- Internet Explorer 11 / Google Chrome
- 2 GB RAM (Windows 7 SP1 / Windows 7 Embedded Standard SP1)
- 64 GB hard drive space
- 32-bit color display, 1366 x 768 or 1280 x 960
- 4.0 Windows Experience Index (particularly for graphics)
- 1 USB 2.0 port and 1 Network port

## ***Recommended PC Requirements***

- Intel® Core™ i7 Processor @ 2.0GHz
- Internet Explorer 11 / Google Chrome
- 8 GB RAM (Windows 7 SP1 / Windows 10 x64)
- 128 GB hard drive space
- 32-bit color display, 1920 x 1080
- 5.0 or greater Windows Experience Index
- 1 USB 2.0 port and 1 Gigabit Network port (Intel Chipset recommended)



# 1 Quick Start

## Contents

AutoVISION Overview .....	1-2
Select a Device .....	1-13
Adjust Camera Settings .....	1-14
Edit the Job .....	1-15
Run the Job.....	1-16
Save the Job.....	1-17

This section provides an overview of **AutoVISION** and describes how to set up a simple vision job quickly so you can get a sense of the software's capabilities. Detailed setup information is available in subsequent sections.

# AutoVISION Overview

## Navigator Bar



The **Navigator Bar** allows for quick switching between views.

There are four main views within AutoVISION:

- **Connect:** Select a device.
- **Image:** Adjust image settings such as **Focus**, **Gain**, and **Shutter**.
- **Edit:** Build an inspection using machine vision tools and adjust job settings.
- **Run:** Monitor the status of a running job.

## File Menu

The file menu allows you to create a new job or open an existing job, open a recent job, save a job (.avp), archive a job (.avz), open the **AutoVISION Options** dialog, or exit AutoVISION. The **New**, **Open**, **Save**, and **Save As** options are also available on the toolbar as icons that match the icons shown in the dropdown menu.

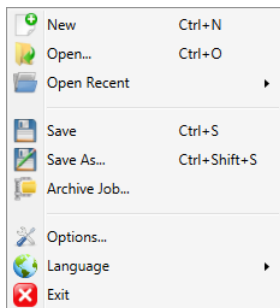

- **New:** Start a new job.
- **Open:** Open a saved job.
- **Open Recent:** Open a recent job.
- **Save:** Save current job (.avp file).
- **Save As:** Rename and save current job (.avp file).
- **Archive Job:** Compress a job and its supporting files in an .avz archive file (also saves the job as an .avp file).
- **Options:** Open **AutoVISION Options** dialog.
- **Language:** Select the preferred language for the AutoVISION user interface.
- **Exit:** Exit current job or close AutoVISION.



## File Menu Toolbar



The available commands in the file menu toolbar include **Create a New Job**, **Open an Existing Job**, **Save Job to Disk**, **Save Job with a New Filename**, **Save Job to Flash**. If the user selects the flash option, AutoVISION will ask if they want to download the job to the camera before saving the job to flash.

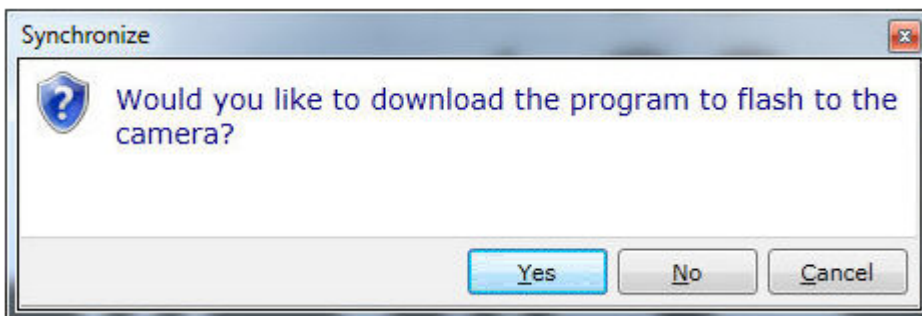

## Help Menu

The Help dropdown menu allows you to see **AutoVISION Help**, the **About AutoVISION** dialog, a **Contacting Omron Microscan** dialog, and a **Check for Updates** dialog.

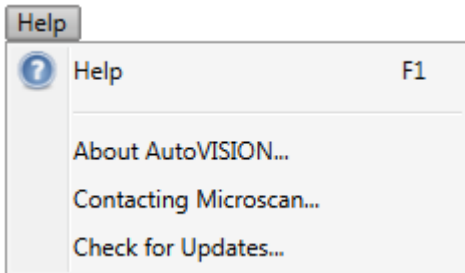

The help documentation can be opened from the **Help** dropdown menu, the **F1** key, or the help icon on the right side of the application:



The help file will be closed when the application is closed or when the user closes the help file.

## About AutoVISION

The **About AutoVISION** dialog shows the name and version of the software, as well as the part number and copyright information. Clicking **More Info** takes the user to an AutoVISION Support page on the Omron Microscan website.



## Contacting Omron Microscan

The **Contact Information** dialog shows the primary addresses of Omron Microscan's global headquarters. There is also a link to the Omron Microscan website.

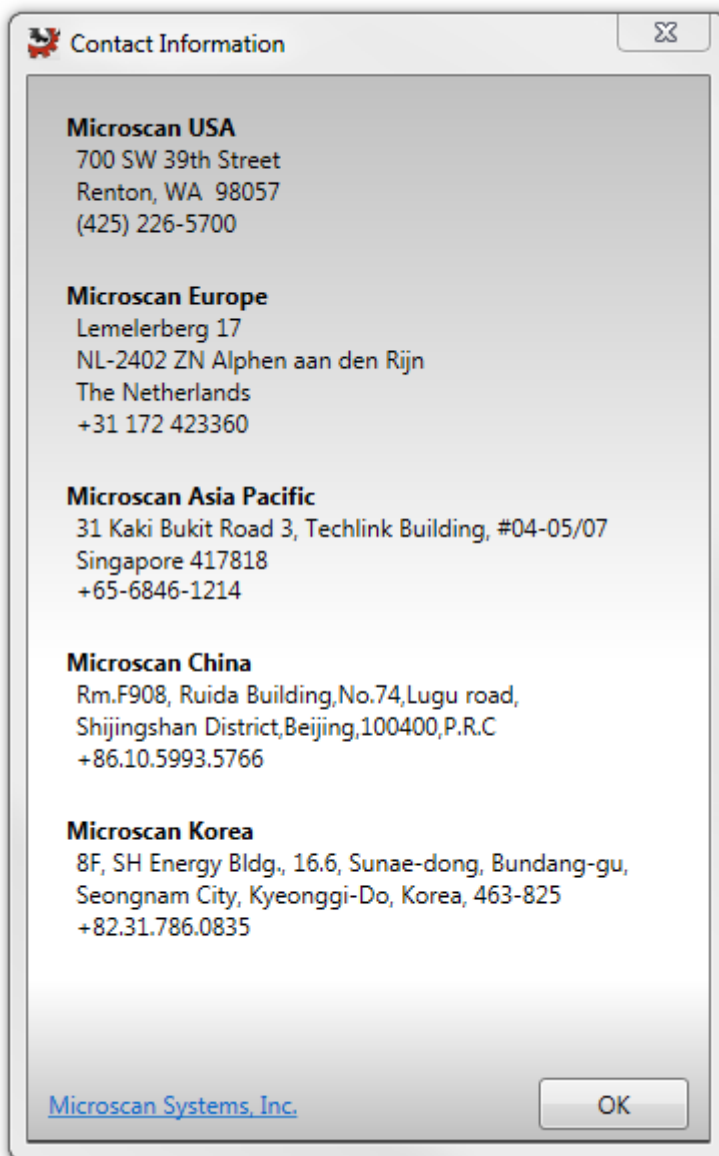

## **Check for Updates**

When you select **Check for Updates** from the Help dropdown, AutoVISION determines whether or not you are running the most current version of the software. If your version of AutoVISION is not current, you will be prompted to update AutoVISION.

If you check the **Automatically check for updates** box, AutoVISION will check for newer versions of the software once a week. Every time you check for a newer version yourself, AutoVISION's "check for updates" timer is reset.

## Status Message List

The **Status Message List** can be opened by clicking the Status Message List icon to the left of the help icon in the upper right of the screen:



The Status Message List allows you to view a history of all status messages shown by AutoVISION during the current session.

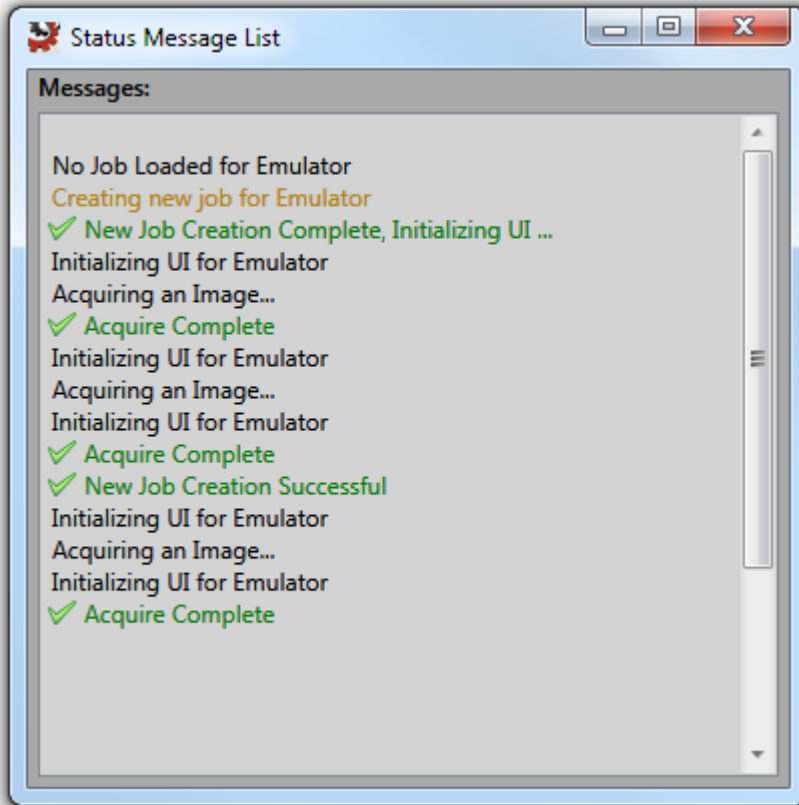

## Status Bar

The status bar appears at the bottom of the main window and contains the following information:

- The currently selected device;
- Device IP address;
- The grayscale value under the cursor (when hovering over the image);
- The X,Y position of the cursor in pixel coordinates.

## AutoVISION Options

The **AutoVISION Options** dialog allows you to control AutoVISION's startup behavior and security settings. On the **Startup** tab, you can set the software to **Auto Connect** to a smart camera that you select from the dropdown menu, to **Auto Load** the most recent job, and to go directly to **Run** mode at startup. You can also password protect the user interface from the **Security** tab.

### Startup

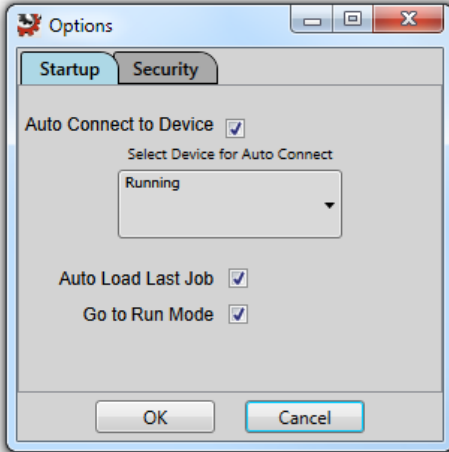

**Auto Connect to Device:** When this option is selected, AutoVISION will connect to the current device automatically the next time the software is opened.

**Auto Load Last Job:** When this option is selected, AutoVISION will automatically load the most recent job the next time the software is opened.

**Go to Run Mode:** When this option is selected, AutoVISION will skip the Connect, Image, and Edit steps and open in Run mode.

### Security



**Enable Password Protection:** Password protection is disabled by default. Selecting this option imposes four separate AutoVISION access levels: Operator, Supervisor, Engineer, and Administrator. Passwords can only be changed by an Administrator, and only an Administrator can return to the Security tab.

**Revert to Operator Mode After...:** When password protection is enabled, you can use this dropdown menu to specify a period of inactivity after which AutoVISION will revert to Operator mode, which limits access to the Run view.

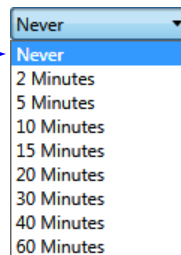

## User Access Levels

When password protection is enabled, AutoVISION provides four levels of access:

### Operator:

An Operator can monitor the **Run** view of AutoVISION, but cannot access other screens or change settings.

### Supervisor:

A Supervisor can switch to **Edit** mode and adjust ROI positions, retrain tools, change the selected device, save the current job, or load a different job. A Supervisor cannot modify the parameters of the current job or add or remove tools.

### Engineer:

An Engineer has full access to all settings and is only restricted from changing passwords.

### Administrator:

An Administrator has full access to all settings, and can change the passwords for all access levels.

## Changing the Access Level

When password protection is enabled, AutoVISION will always start with the access level set to **Operator**, which blocks access to the **Connect**, **Image**, and **Edit** views. You can change the access level by clicking the icon shown below and entering as an **Administrator**.

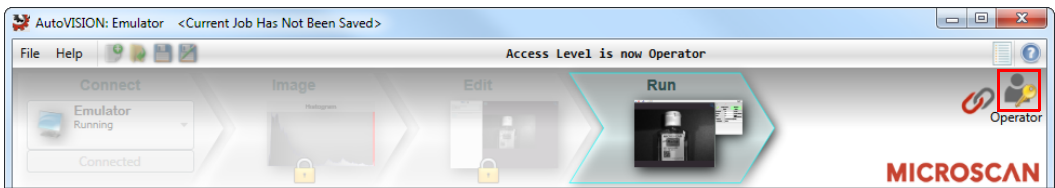

Your current access level is always displayed in text below the icon. Click the icon to display the following dialog:



This dialog provides a button for each of the four access levels. The highlighted button shows the current access level.

---

## AutoVISION Overview

To switch to any of the other three access levels, click the button of the desired access level and you will be asked for the that access level's password. To switch to Engineer, for example, click the **Engineer...** button. You will then see the password field:

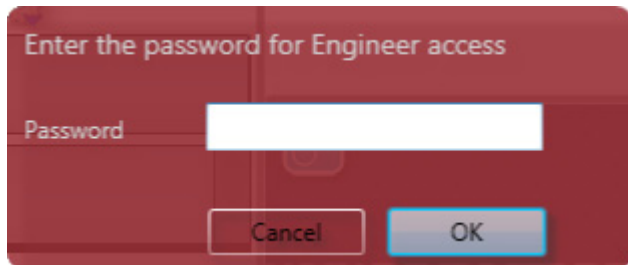
A screenshot of a dark red dialog box with rounded corners. At the top, the text "Enter the password for Engineer access" is displayed in a light color. Below this, the word "Password" is positioned to the left of a white rectangular input field. At the bottom of the dialog, there are two buttons: "Cancel" on the left and "OK" on the right. The "OK" button has a blue border and a slight shadow.

Enter the password and click **OK**. If the password is correct, the access level is changed. If the password is incorrect, an error message is displayed and the access level remains unchanged.

The default passwords for the four access levels are:

- **Operator:** No password required.
- **Supervisor:** supervisor
- **Engineer:** engineer
- **Administrator:** administrator

Once you have entered the password for a particular level, you don't need to enter a password to reduce your access level. For example, if you currently have Administrator access, you can click on the Engineer or Supervisor buttons and your access level will be reduced instantly. You only need to enter a password when you are increasing your access level.



## Changing Passwords

You must be an Administrator to change the password of any access level. If you change your access level to Administrator, the **Change Password...** button at the bottom of the **Select Your Security Access Level** dialog will be enabled:

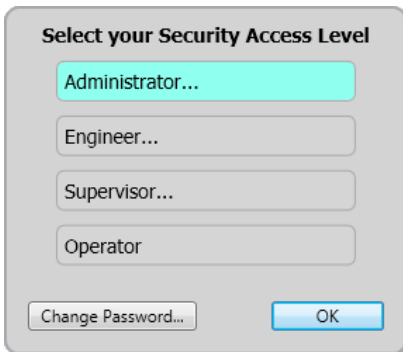

Clicking **Change Password...** brings up the **Change Access Level Passwords** dialog:

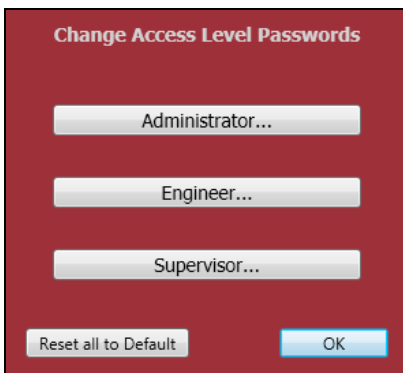

Click the button that corresponds to the access level whose password you wish to modify, and the **Change the Password** dialog will appear:

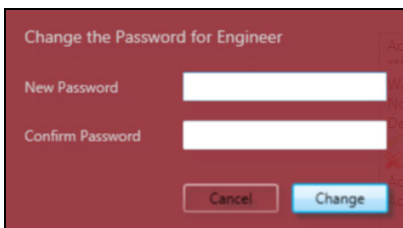

Click the **Reset All to Default** button on the **Change Access Level Passwords** dialog to return all passwords to default.

## Minimum Access Levels

AutoVISION defines the minimum access level for the various regions of the user interface and for several features of the software. The following tables show the securable areas of AutoVISION and the minimum access level required for each.

### Edit View

UI Region/Feature	Minimum Access Level
Edit View	Supervisor
Parameter Page	Engineer
Delete Tool button	Engineer
Toolbox (ability to Add a Tool)	Engineer

### Image View

UI Region/Feature	Minimum Access Level
Image View	Engineer

### Connect View (Device Selection View)

UI Region/Feature	Minimum Access Level
Connect View	Supervisor
Change job in Flash	Supervisor
Delete a job in Flash	Administrator
Modify Device Settings	Supervisor

### Application-Wide Options

UI Region/Feature	Minimum Access Level
Job Save	Supervisor
Job Load	Supervisor
Options dialog	Engineer
Exit the application	Supervisor
Flash a job on the camera	Engineer
Access the Data Navigator	Engineer

## Select a Device

AutoVISION's **Connect** view allows you to select your camera from a dropdown list and configure its settings, and to create a new job.

The software emulator allows you to work from saved images without hardware.

Once a device is selected, you can **Create a New Job**, **Load a Job** from a saved .avp file on your PC, or **Upload Current Job from Device** (your camera).

- **Job:** A completed program, including image acquisition, tools, and reporting.
- **Tool:** A self-contained set of steps used to perform a specific task.

**Note:** When selecting the Emulator, there is no option to upload a job.

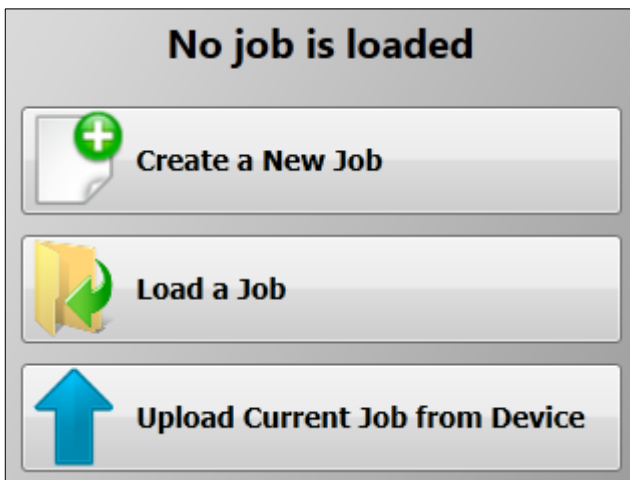

# Adjust Camera Settings

Once you have selected your camera or the Emulator and created a new job, you will move to the **Image** view. This view allows you to **Auto Calibrate** the camera, and to manually adjust the camera's **Exposure**, **Gain**, and **Focus**, and also to set the **Lighting Mode (On, Off, or Strobe)**.

**Note:** If you load a job from your PC or upload a job from the camera, you will automatically move to the **Edit** view.

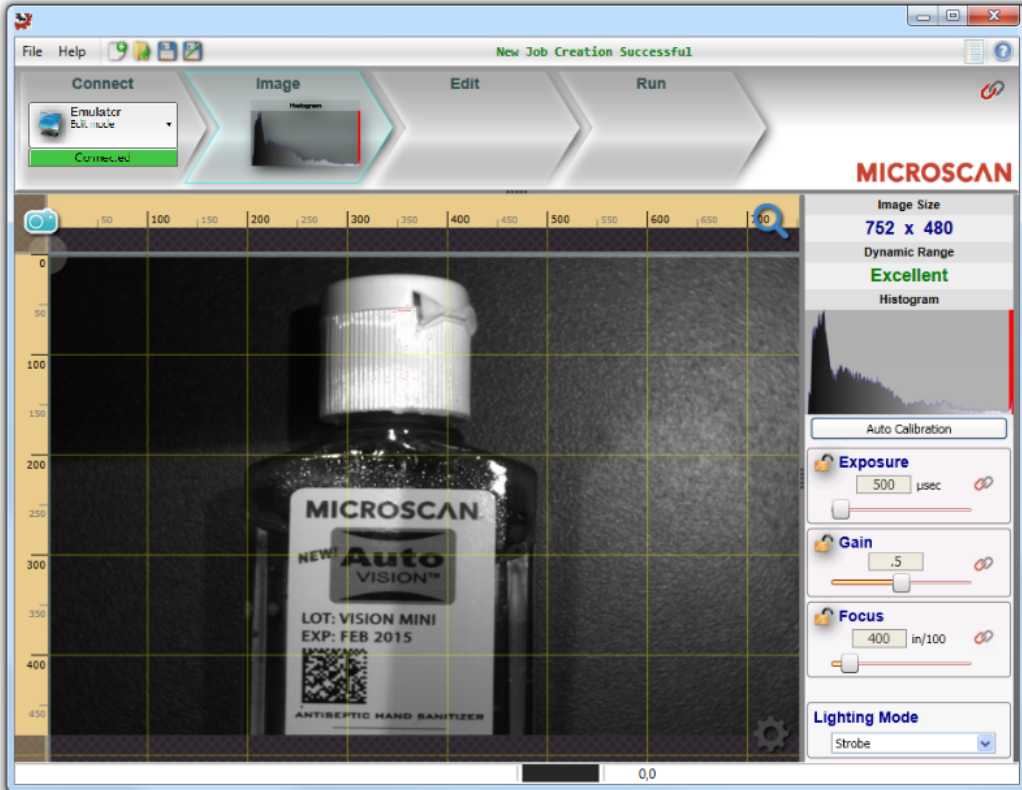

You can return to the **Connect** view and click the **Modify** button to adjust additional camera settings, such as **TCP/IP** settings, **Industrial Protocol** settings, **RS-232** settings, **Ethernet** settings, and **AutoVISION button** settings. You can also rename your camera (alphanumeric characters only - [0-9], [a-z], and [A-Z]). Click the **Apply** button when you have adjusted the camera's settings as needed.

## Edit the Job

After you have created a new job, loaded a job from your PC, or uploaded a job from the camera, you will proceed to the **Edit** view to refine your machine vision job.

The **Camera** parameters allow you to set **Gain**, **Exposure**, **Focus**, **Trigger**, and **Lighting**. **Inspection Outputs** options and **Omron Microscan Link** functionality allow you to connect your job to the outside world.

This is also the view where you can add multiple tools to the job. The tool icons are located above the main view area.



When a tool is selected, it appears in the job list area to the left of the main view.

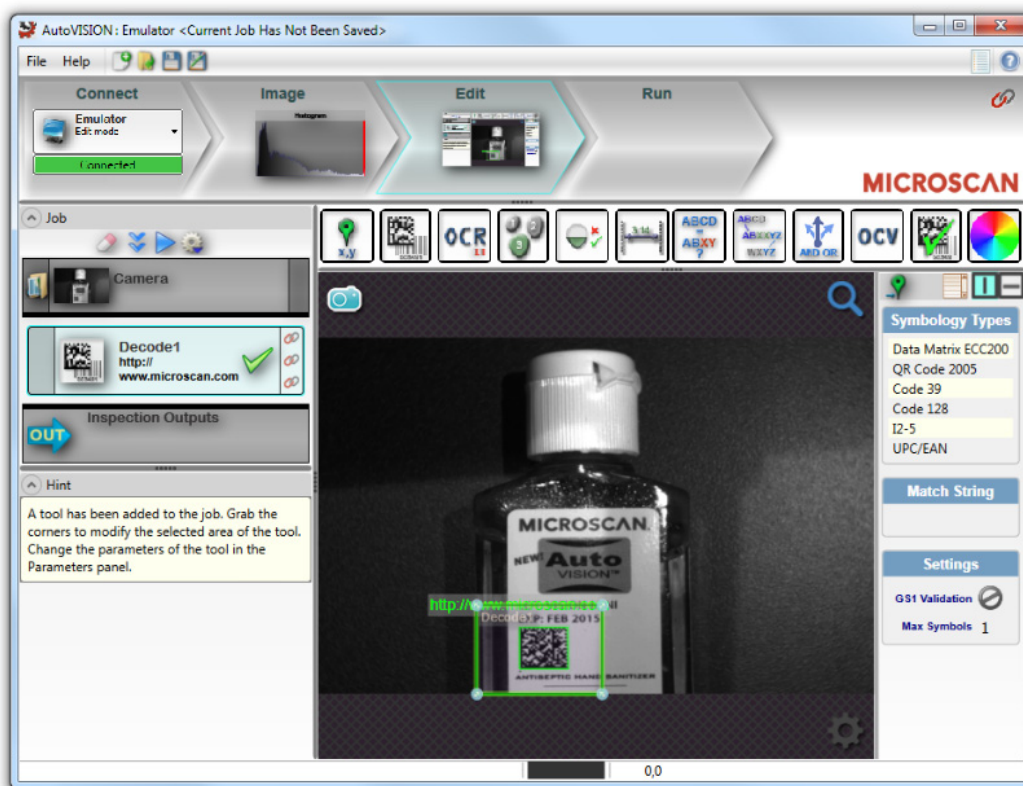

# Run the Job

Going to the **Run** view will automatically download your job to the camera and start it running.

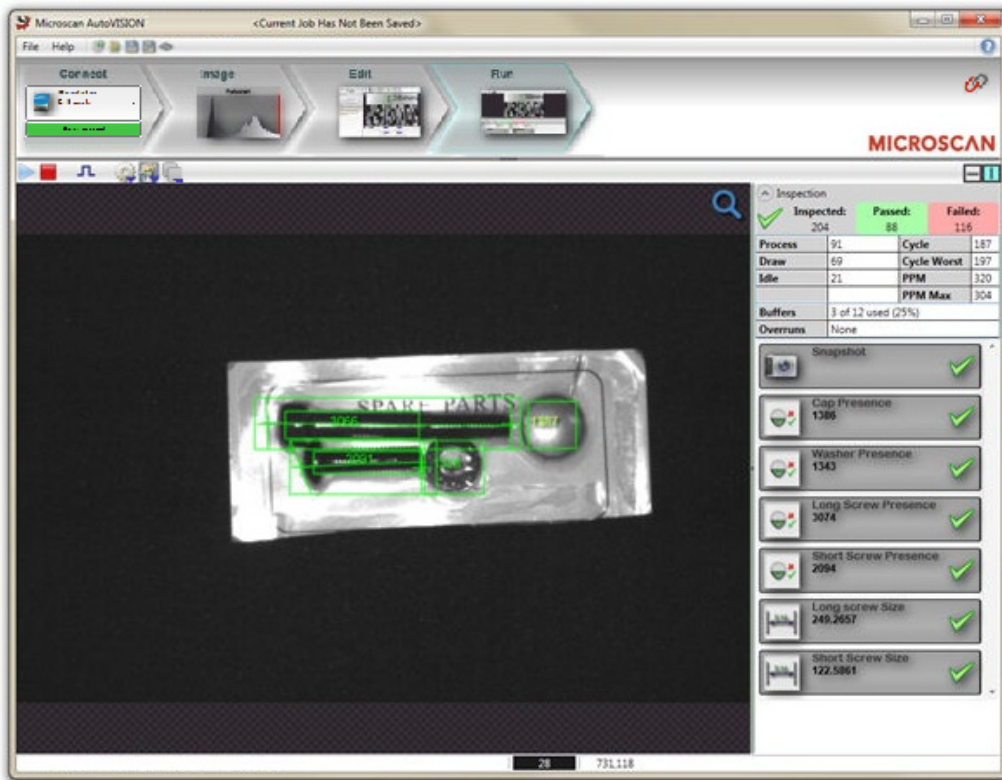

## The Run view provides the following feedback:

- **Image Display:** Displays runtime images with Tool graphics;
- **Inspection Counts:** Displays the number of parts inspected, passed and rejected;
- **Inspection Timing Statistics:** Displays statistics on the speed of your inspection;
- **Tool Results:** Shows the Pass/Fail status and inspection data from each of your Tools.

## The following options are provided:

- Adjust the speed of the image display;
- Enable/disable graphics display;
- Save uploaded images to the PC;
- Clear the inspection counts.

## Save the Job

Click the **Save** icon to save the job to the smart camera's flash memory.

**Note:** The Save icon shows a popup menu of jobs, allowing you to overwrite existing jobs or to create a new job.



1. Click the **Stop** icon.
2. Click the **Save** icon.
3. Click the **Run** icon to start again.

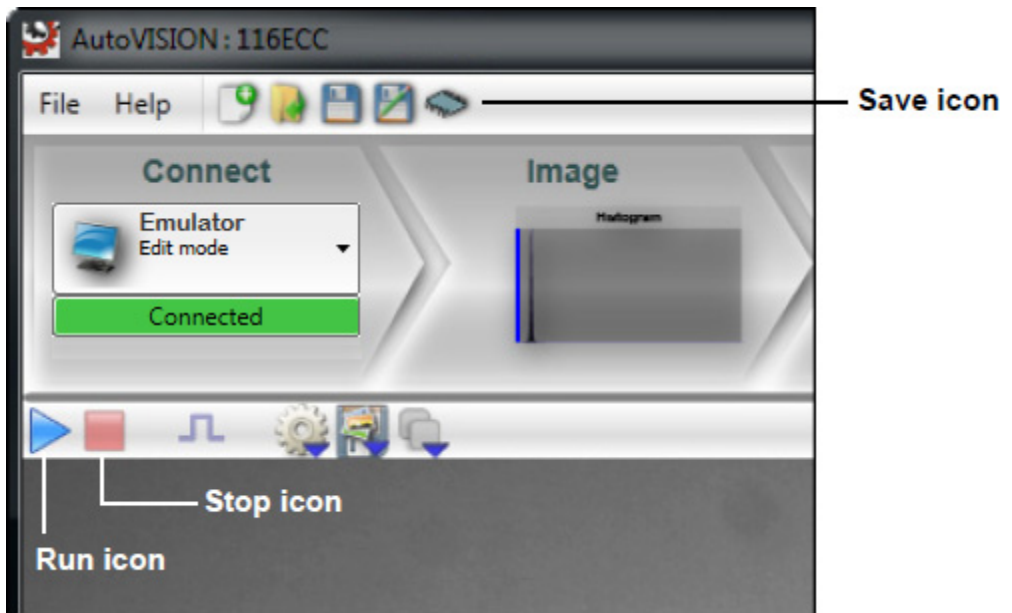

Note that jobs that are configured to run on stored images, saved, and then opened on a camera, will have their snapshot setting changed to **Acquire**.

---

*Save the Job*





# 2 *Connect*

## **Contents**

Launch the AutoVISION User Interface .....	2-2
Select Device .....	2-3
Job Changeover.....	2-5

This section describes how to launch **AutoVISION**, select a device, and connect.

---

*Launch the AutoVISION User Interface*

## **Launch the AutoVISION User Interface**

Double-click the AutoVISION icon on your desktop or go to the Windows Start Menu and navigate to **All Programs > Omron Microscan AutoVISION > AutoVISION**.

## Select Device

AutoVISION's **Connect** view allows you to select your device and configure its settings, and to create a new job.

**Note:** The software emulator allows you to work from saved images without hardware.

### Modifying Device Settings

When you click the **Modify** button, device settings under **Details** can be changed.

**Note:** If DHCP is disabled at startup and you click **DHCP Enable**, the IP Address and Subnet Mask fields are read-only and show the camera's current static IP Address and Subnet. If DHCP is enabled at startup, the IP Address and Subnet Mask assigned by DHCP are shown.

**Important:** The HAWK MV-4000 and the MicroHAWK have different default IP addresses:

- The HAWK MV-4000's default IP address is: **192.168.AA.BB**, where **AA.BB** are the last **2** octets in decimal of the device MAC with subnet Class B 255.255.0.0. Set your PC to the same subnet (**192.168.0.1**, for example).
- The MicroHAWK's default IP address is: **192.168.188.2**. Set the PC to same IP range (**192.168.188.100**, for example).

You can also create or change a username and password for your camera to protect device settings.

Create or change a username and password by right-clicking on the image of the camera and then clicking **Change User ID and Password**.

Then enter your new username of choice and password of choice and click the **Change** button:

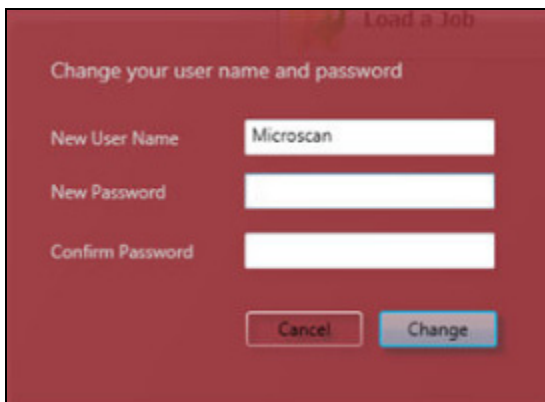

Change your user name and password

New User Name

New Password

Confirm Password

---

## Select Device

Subsequent attempts to change device settings will require that the current username and password be entered:

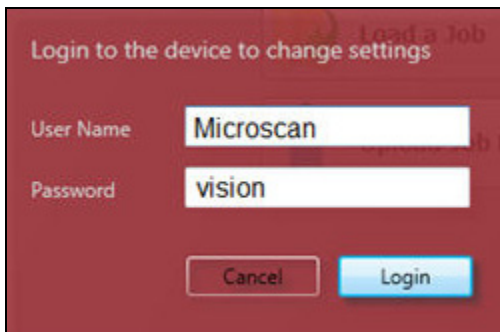

A login dialog box with a dark red background. At the top, it says "Login to the device to change settings". Below this, there are two input fields: "User Name" containing "Microscan" and "Password" containing "vision". At the bottom, there are two buttons: "Cancel" and "Login".

**Important:** AutoVISION is not able to edit jobs that have been manipulated in FrontRunner. Switching jobs between AutoVISION and FrontRunner is not recommended.

Once a device is selected and its settings are configured, you can **Create a New Job**, **Load a Job** from a saved **.avp** file on your PC, or **Upload Current Job from Device** (your camera).

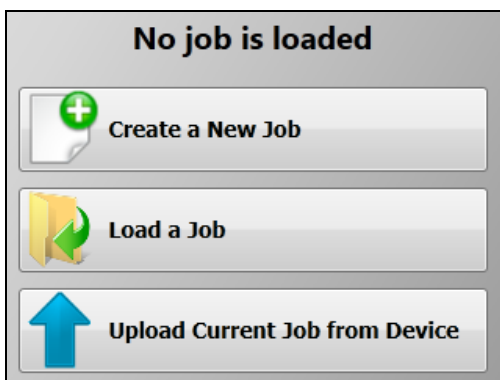

A menu titled "No job is loaded" with three options, each with an icon and text:

- Create a New Job**: Represented by a white document icon with a green plus sign.
- Load a Job**: Represented by a yellow folder icon with a green arrow pointing left.
- Upload Current Job from Device**: Represented by a blue arrow pointing up.

# Job Changeover

Multiple jobs can be loaded to the camera. You can switch between the jobs without having to download each time. A number of features allow you to manipulate the jobs and retrieve information about the loaded jobs.

**Job Slot** – Each job is stored in a corresponding "slot" in the camera's memory, identified by a consecutive list of integers.

**Boot Job** – This is the job that loads when the camera is powered on.

**Current Job** – This is the job that is currently loaded in the camera's memory. AutoVISION allows the user to select a job in the job slots and make it the current job.

You can manipulate Job Changeover functionality in AutoVISION's **Connect** view, with the pop-up menu that appears when you click the flash memory icon on the file menu toolbar, and with the pop-up menu in the **Run** view.

When you select a camera that supports Job Changeover, the jobs are shown under the **Upload Current Job from Device** button in the device view.

**Note:** Job sizes are not shown until you log in to the camera.

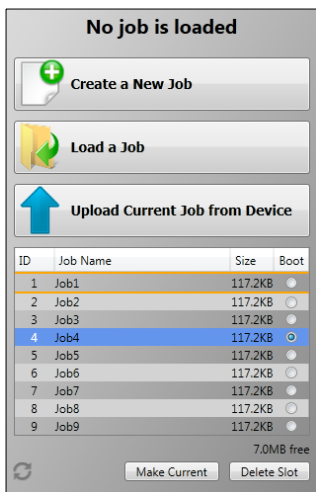

From this view you can see the following information about the job:

- Slot **ID**
- **Job Name** (.avp name)
- **Size** of the job
- Memory available on the camera
- Which job is the **Boot Job**
- Which job is the **Current Job** (highlighted in orange)

**Size** represents the amount of memory that would be saved if the job were deleted from the camera. The jobs share support files, so when there are two jobs using the same support files the second one deleted will make more memory available.

## Job Changeover

You can make a job the current job by selecting it and clicking the **Make Current** button. You can also delete jobs from the camera by selecting a job and clicking the **Delete Slot** button. AutoVISION will warn you if you try to delete the current job, and will automatically reassign the new first job in the list to current.

The pop-up menu that appears when you click the flash memory icon allows you to see all jobs currently on the camera. You can then flash the job that is in the camera's memory or loaded on the computer by selecting a job to overwrite or by selecting **New Slot**.

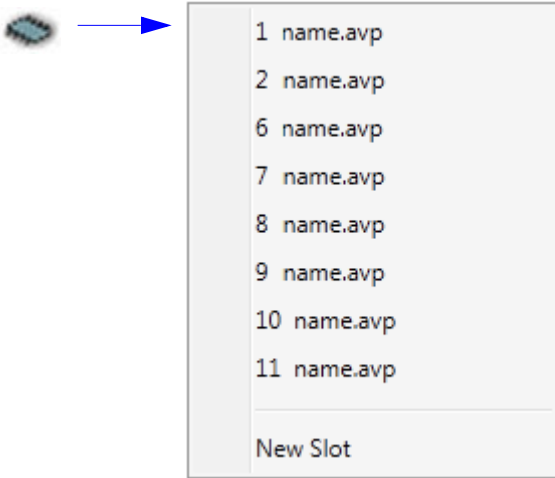

When you select a slot (or New Slot) you will see a dialog asking if you want to download the current job. This allows you either to flash the job in AutoVISION or the job on the camera. If you select New Slot, AutoVISION will search for an open slot or the next corresponding job slot and insert the job in that slot. After the job is flashed it will start running and AutoVISION will switch to the Run view if you have checked “Go to Run view after flashing the job”.

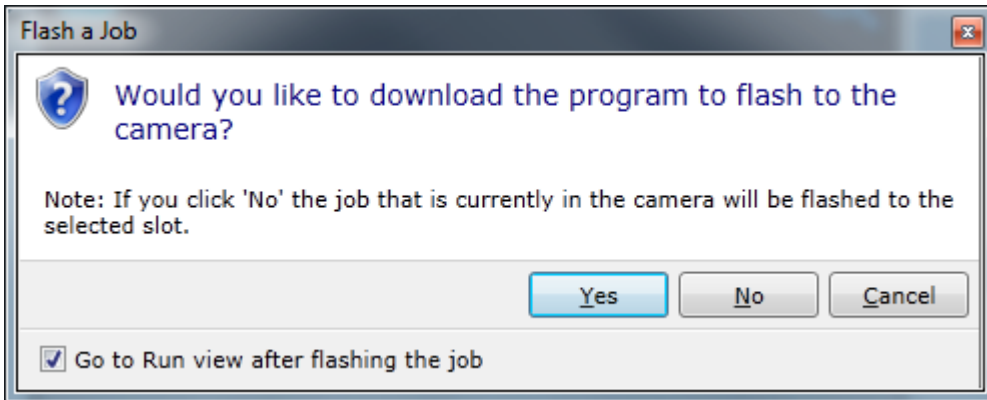

## Job Switching

**Important:** AutoVISION is not able to edit jobs that have been manipulated in FrontRunner. Switching jobs between AutoVISION and FrontRunner is not recommended.

You can switch between jobs in AutoVISION's **Connect** or **Run** views. Click the job switch icon in the Run view to use the dropdown menu shown below.

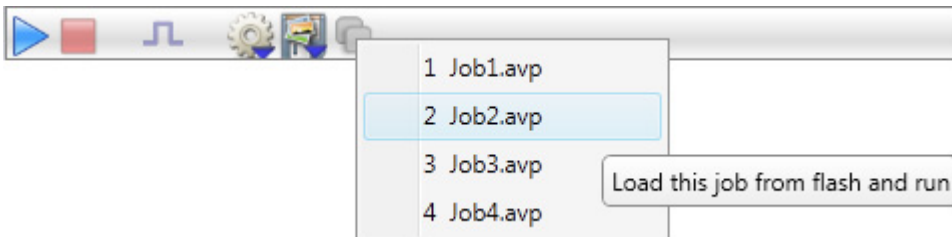

If a username and password have been defined for the camera, the **Login** dialog will appear.

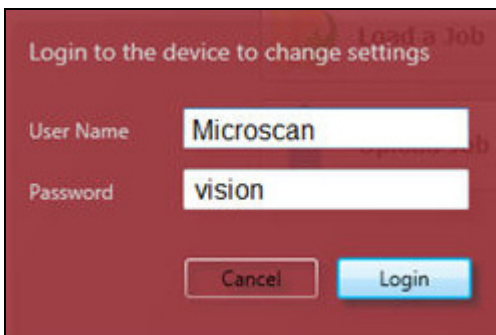







# 3 *Image*

**Contents**

Image Overview ..... 3-2  
Image Area ..... 3-3  
Image Control Tools..... 3-4  
Auto Calibration ..... 3-6

This section describes **AutoVISION's Image** area, how to use the image control tools, and how to **Auto Calibrate** on an acquired image.

# Image Overview

The **Image** view allows you to calibrate your camera's focus and lighting settings automatically via the **Auto Calibration** button, or to adjust them manually via the **Exposure**, **Gain**, **Focus**, and **Lighting Mode** parameters. Calibration settings are saved to the camera, as are Exposure, Gain, and Focus settings that are adjusted manually.

The upper-right corner of the view provides feedback on the current image, including its width and height, the quality of its **Dynamic Range (Excellent, Good, Fair, Poor)**, and a histogram of the image to help you visualize the Dynamic Range. The colors blue and pink in the image are used to show undersaturated (blue) and oversaturated (pink) pixels.

The **photometry** values (**Exposure**, **Gain**, and **Focus**) shown to the right of the image area are determined either by the AutoVISION job or by photometry values stored on the camera. There are multiple ways these values can be set: manually with the sliders, Auto Calibration in AutoVISION, Auto Calibration with the **AutoVISION button**, and **Omron Microscan Link**.

When you perform an Auto Calibration, the photometry values can be "locked down" so they are not changed by the calibration process. When a photometry value is "locked" during calibration, the value already stored in the AutoVISION job (not on the camera) is used.

**Note:** Photometry values must be locked if you intend to tie them to AutoVISION/Visionscape global data service (GDS) tags using Omron Microscan Link. Locking the values allows any new values that appear in the job to be used. If photometry values are unlocked, the values stored on the camera will be used, but they cannot be changed using Omron Microscan Link.

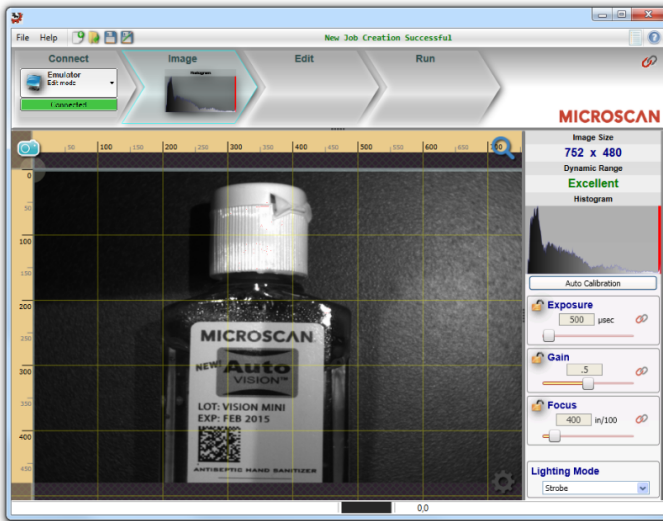

**Note:** **Auto Calibration**, **Exposure**, **Gain**, **Focus**, and **Lighting Mode** do not function when the Emulator is being used instead of a camera.

# Image Area

The **Image Area** displays the current image and features various tools for controlling the image.



**Hint:** Right-click in the image area and move the mouse to drag the image to the desired position. Use the mouse wheel to zoom the image in or out.

# Image Control Tools

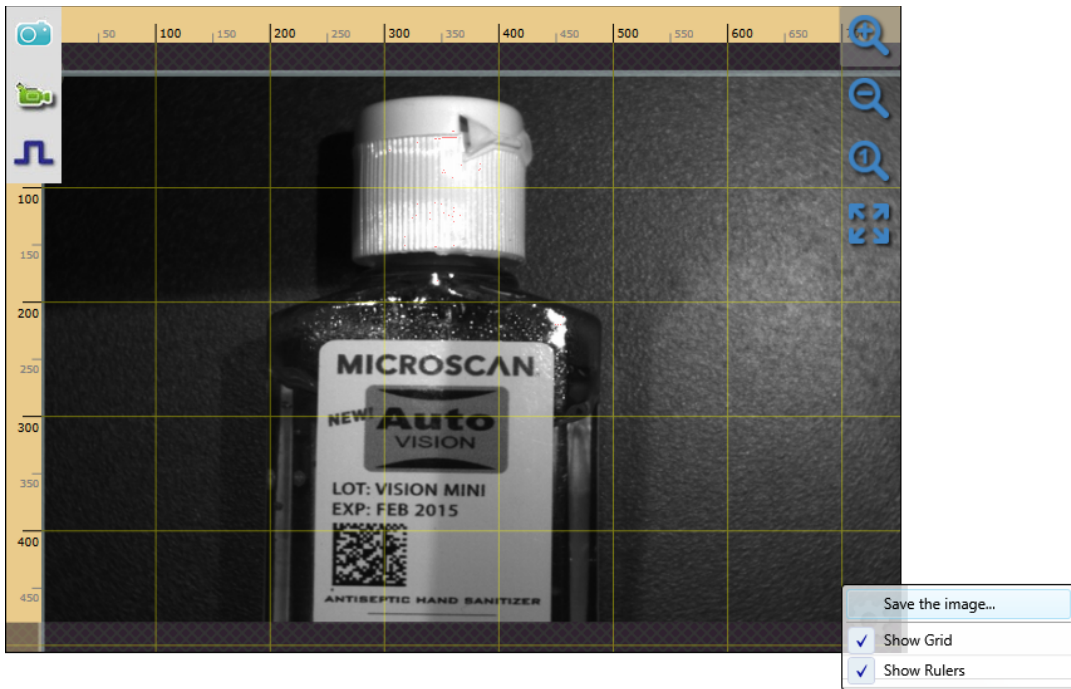

## Acquire

**Acquire Single Image:** Takes a single picture.



**Acquire Live Images:** Live video used for camera and part adjustment.



**Enable or Disable Trigger for Image Acquisition:** When checked, and your camera has a trigger assigned, Acquire, Live Video and Tryouts will all wait for a trigger before acquiring an image.



## **Zoom**

**Zoom In:** Makes the image appear larger.



**Zoom Out:** Makes the image appear smaller.



**Actual Size:** Shows the image at actual size in pixels.



**Fit to Screen:** Fits the image to the boundaries of the image area.



## **Options**



**Save the Image...:** Saves the captured image on the PC.

**Show Grid:** Places grid lines on the image for reference and measurement in pixels.

**Show Rulers:** Places rulers (in pixels) above and to the left of the image area.

# Auto Calibration

AutoVISION performs **Acquisition Calibration**, which configures the camera sensor's **Focus** setting via an auto-focus step, and configures the **Exposure** and **Gain** settings via an auto-photometry step. The calibration process ensures that the camera captures and sends optimal images to the software for analysis.

Click the **Auto Calibration** button in AutoVISION's **Image** view to perform a quick calibration on the image.



To perform **Auto Calibration** in AutoVISION's Image view, click the Auto Calibrate button to the right of the main image area. AutoVISION performs a quick calibration on the image in the field of view and provides output on **Image Size** and **Dynamic Range**, and also shows a **Histogram** for the captured image.

You can also adjust **Exposure**, **Gain**, and **Focus** individually, and set the **Lighting Mode** as discussed in [Image Overview](#).

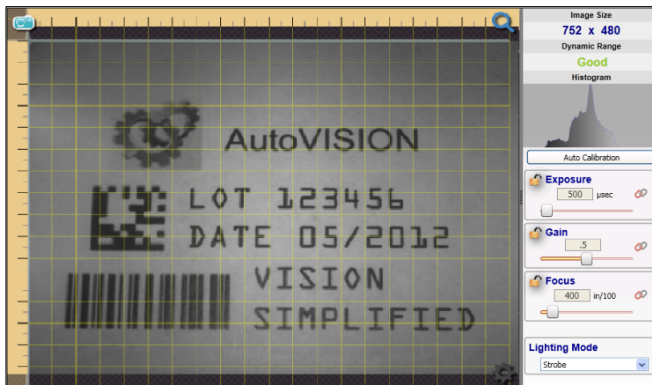

**Auto Calibration** configures the camera's **Focus**, **Exposure**, and **Gain** settings and shows a histogram for the captured image.

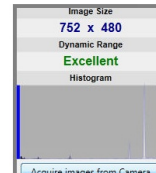

To enable Auto Calibration the image source must be the camera

The image control settings are only available when a camera is connected and the image source is the camera.

**Important:** The image source must be the camera for these controls to be enabled. If you see the **Acquire Images from Camera** button instead of the **Auto Calibration** button, click it to make the camera the image source and capture an image. The Auto Calibration button and other controls will then be enabled.

## Lighting Mode

Allows you to select between **Off**, **On**, **Strobe**, **Power Strobe**, or **External Strobe**. Power Strobe mode is limited to a maximum **1 ms** pulse width (as with Omron Microscan's NERLITE Smart Series Illuminators).

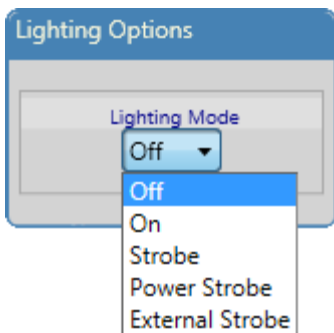

When Lighting is set to **Off**, external lighting is disabled, and internal lighting is turned off.

When Lighting is set to **On**, external lighting is enabled (Output 3 is placed in a de-energized or open state) and internal lighting is enabled.

When Lighting is set to **Strobe**, Output 3 is enabled to control an external light. The normal state for Output 3 in this configuration is in an energized or closed state. At the start of an image acquisition the output is de-energized or placed in an open state. At the end of the camera's exposure period, the output is set back to a closed state. Strobe operation allows you to connect the appropriate NERLITE external lighting product for your application and to control that light in sync with image acquisition. The light can be switched on fast enough that it is at full brightness before the exposure begins.

### Power Strobe and External Strobe

Power Strobe and External Strobe allow you to select different lighting configurations when acquiring an image.

**Note:** Power Strobe does not function with rolling shutter.

### Lighting Select

Allows you to select between Internal WHT, Internal RED, or Expansion lighting. This setting is used in conjunction with the Lighting Mode selection.

### External Strobe Control

Allows you to select which output is used to control the External Strobe. The selected output is no longer available for use elsewhere in the job.

**Note:** There are no outputs available for MV-20.

## Lighting Mode Table

Light Mode Table	Inner LEDs	Outer LEDs	Off	On	Strobe	Power Strobe Inner LEDs	Power Strobe Outer LEDs	External Strobe
Engine USB Power	Yes	No	Yes	Yes	Yes	No	N/A	Yes
Engine Ext Power	Yes	No	Yes	Yes	Yes	No	N/A	Yes*
MV-20	Yes	No	Yes	Yes	Yes	No	N/A	No
MV-20 Color	Yes	No	Yes	Yes	Yes	No	N/A	No
MV-30 USB Power	Yes	Yes	Yes	Yes	Yes	No	No	Yes**
MV-30 External Power	Yes	Yes	Yes	Yes	Yes	No	Yes	Yes
MV-30 Color	Yes	Yes	Yes	Yes	Yes	No	Yes	Yes
MV-40	Yes	Yes	Yes	Yes	Yes	No	Yes	Yes
MV-40 Color	Yes	Yes	Yes	Yes	Yes	No	Yes	Yes

\* If using breakout cable for engine

\*\* If using correct accessory breakout cable

See the *Visionscape Tools Reference Manual* for more information about lighting modes.



# 4 Edit

## Contents

Edit Overview .....	4-2
Image Control Tools.....	4-4
Tools Overview .....	4-6
Camera .....	4-28
Locate Tool .....	4-34
Decode Tool.....	4-37
OCR Tool .....	4-41
Count Tool .....	4-55
Presence/Absence Tool.....	4-60
Measure Tool .....	4-63
Match Strings Tool.....	4-82
String Format Tool .....	4-84
Logic Tool .....	4-86
OCV Tool .....	4-90
Symbol Quality Verification Tool.....	4-93
Color Tool .....	4-119
Inspection Outputs .....	4-131
Omron Microscan Link .....	4-143
Data Navigator .....	4-148
Terminal .....	4-152
Serial Commands .....	4-155

This section describes how to use the tools in **AutoVISION's Edit** interface.

# Edit Overview

The **Edit** view allows you to edit and try out a job.

**Hint:** Right-click in the image area and move the mouse to drag the image to the desired position. Use the mouse wheel to zoom the image in or out.

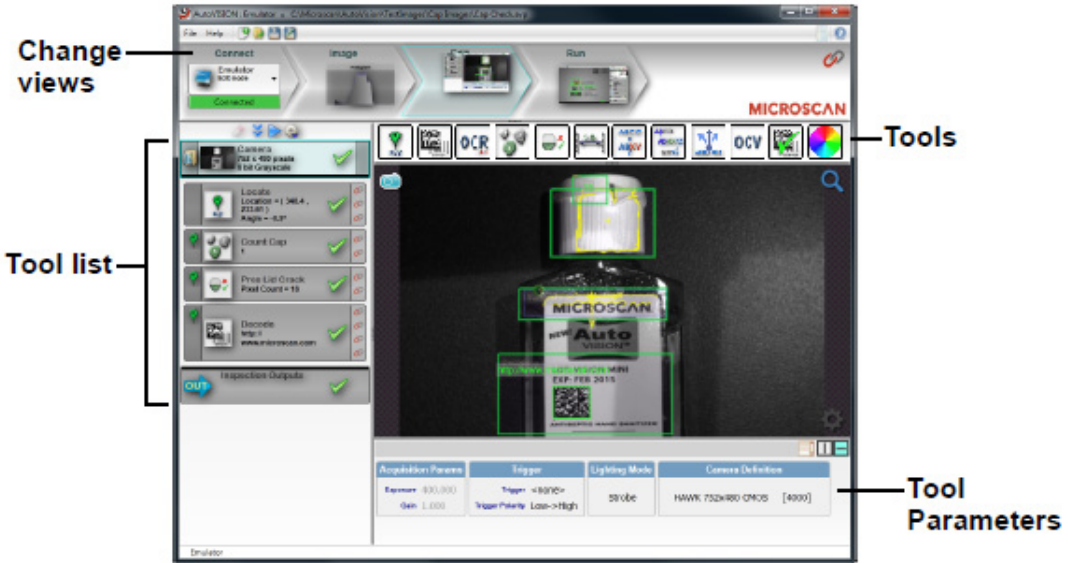

## Job List

The **Job List** displays all tools and represents the order of execution of tool functions. It also displays tool status and data.

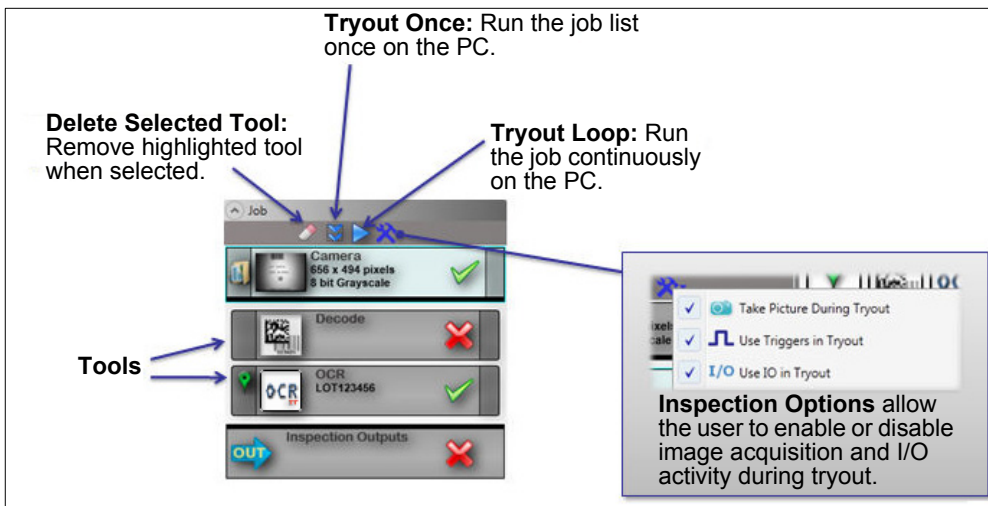

Tools shown in the job list provide information about the current job.

**Note:** The **Camera** and **Inspection Outputs** tools are fixed and cannot be moved from their locations via drag-and-drop.

Tools execute in the order shown in the job list.

1 Camera 656 x 494 pixels 8 bit Grayscale ✓

2 Decode ✗

3 OCR LOT123456 ✓

4 Inspection Outputs ✗

**Camera** step is automatically generated with a new job.

**Tool status:** ✓ PASS ✗ FAIL

**Inspection Outputs** step is automatically generated with a new job.

**Hint:** Drag and drop tools to change the order in the list.

Tools shown in the job list provide real-time feedback.

## Image Area

The **Image Area** displays the current image, tool data, and controls for image adjustment.

**Acquire**

**Zoom**

**Ruler (in pixels)**

**Gridlines every 100 pixels**

**Options**

OCR  
LOT 123456  
DATE 04/2011  
VISION SIMPLIFIED!

**Hint:** Right-click in the image area and move the mouse to drag the image to the desired position. Use the mouse wheel to zoom the image in or out.

# Image Control Tools

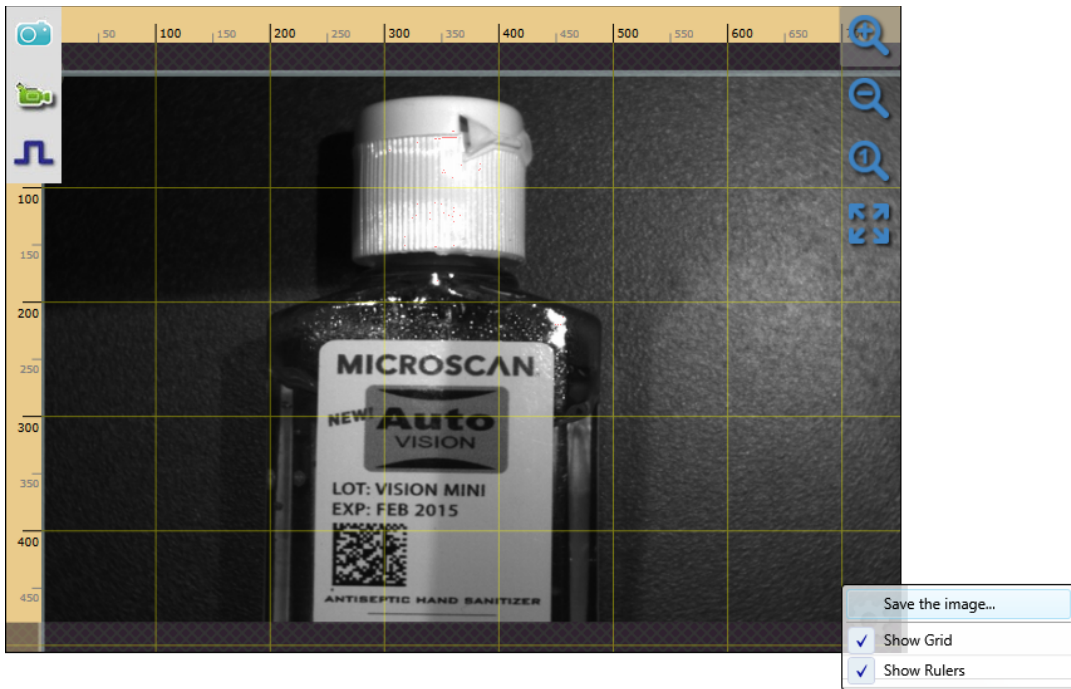

## Acquire

**Acquire Single Image:** Takes a single picture.



**Acquire Live Images:** Live video used for camera and part adjustment.



**Enable or Disable Trigger for Image Acquisition:** When checked, and your camera has a trigger assigned, Acquire, Live Video, and Tryouts will all wait for a trigger before acquiring an image.



## **Zoom**

**Zoom In:** Makes the image appear larger.



**Zoom Out:** Makes the image appear smaller.



**Actual Size:** Shows the image at actual size in pixels.



**Fit to Screen:** Fits the image to the boundaries of the image area.



## **Options**



**Save the Image...:** Saves the captured image on the PC.

**Show Grid:** Places grid lines on the image for reference and measurement in pixels.

**Show Rulers:** Places rulers (in pixels) above and to the left of the image area.

# Tools Overview

The tool icons are located above the main view area.



The following sections describe how to add and configure tools.

## Adding Tools

The tool icons are located above the image area.

There are two ways to add a tool to a captured image:

1. Click on the tool icon.
2. Click and drag a tool icon into the image area, then adjust the region of interest (ROI) by grabbing one of the ROI's four anchor points and sizing the ROI as needed.



## Region of Interest (ROI)

- All AutoVISION tools have an ROI except **Match Strings**, **String Format**, and **Logic**.
- A tool will only execute its function within its own ROI.
- Larger ROIs require more processing time.
- ROIs of different tools can overlap and still function correctly.
- Some ROIs can rotate.

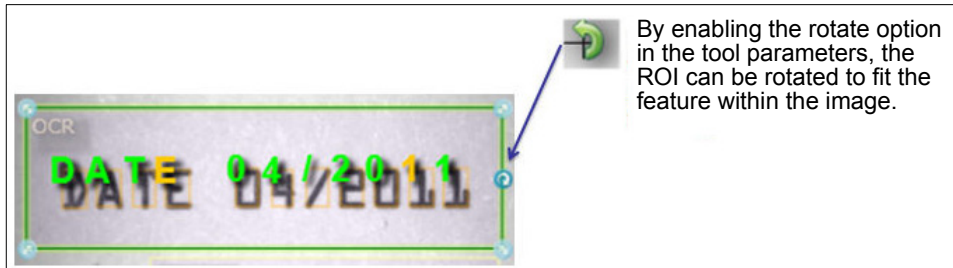

## Dynamic Locate

The **Locate Tool** and **Decode Tool** can be used to locate other tools dynamically, because they report coordinates within the image.

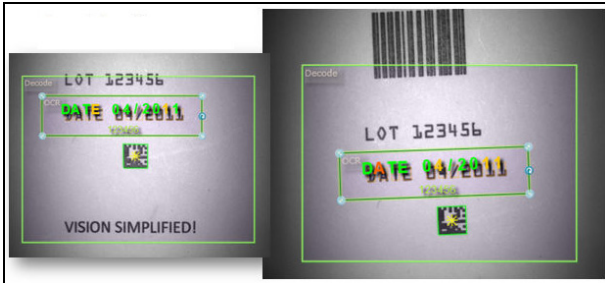

**Dynamic location:** Tools move as features move

## Using Dynamic Locate in the Locate Tool

Once a tool has been set as a location source, other tools can move with it.

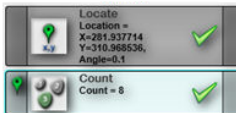

**ON:** Move this tool based on the coordinates reported by the **Locate Tool**.

**OFF:** Do not move this tool based on the coordinates reported by the **Locate Tool**.

Use the **Locate Tool** as a location source for other tools.

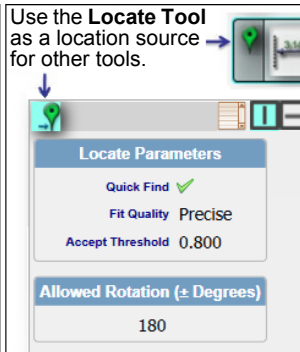

## Using Dynamic Locate in the Decode Tool

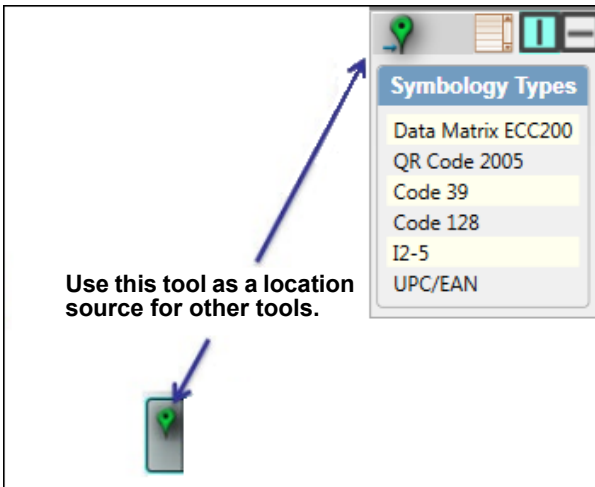

## Image Pre-Processing

Image Pre-Processing is enabled by default.

AutoVISION's Image Pre-Processing algorithms are available for the following tools:

- **OCR Tool**
- **Count Tool (Blob Count)**
- **Measure Tool**

Image Pre-Processing makes it easier for the software to recognize and read characters in an image, detect features in an image, and measure width, height, and angle within an image. The Pre-Processing routine runs before the tool runs.

The Image Pre-Processing editor shown here is visible in the OCR Tool, Count Tool (Blob Count), and Measure Tool's parameters areas.

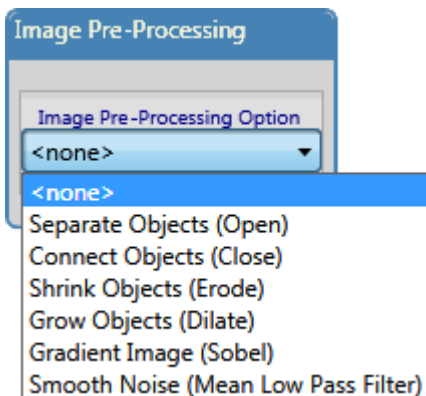



## Separate Objects (Open)

Separate Objects (Open) uses morphological pre-processing to perform an **open** operation. This operation is useful when you want to separate objects from each other, such as multiple connected OCR characters that are connected and are misidentified as a single character. Once this option is selected, the editor is updated to provide parameters specific to the open operation.

**Pixel Polarity** selects the color of the objects you want to separate. **Iterations** sets the number of times the operation is repeated on the image. The effect of the operation is increased as this value is increased. This parameter is defaulted to 1, but you will typically need to increase the number of iterations to achieve the desired effect. **Show Output Image** is enabled by default. The pre-processed image will be shown within the ROI of your tool so you can see the effect of your chosen operation. You can use this option to hide the pre-processed image.

### Separate Objects (Open) Example:



*Count Tool, no image pre-processing, counting one blob.*

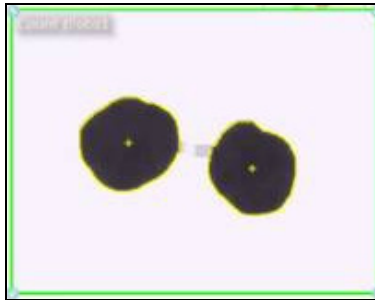

*Count Tool with Separate Objects (Open) enabled, Dark Pixels, 6 Iterations, counting two blobs.*

## Connect Objects (Close)

**Connect Objects (Close)** uses morphological pre-processing to perform a **close** operation. This operation is useful when you want to connect objects to each other, such as multiple dot-matrix-printed OCR characters whose dots are too far apart, making it difficult to segment the characters. Once this option is selected, the editor is updated to provide parameters specific to the close operation.

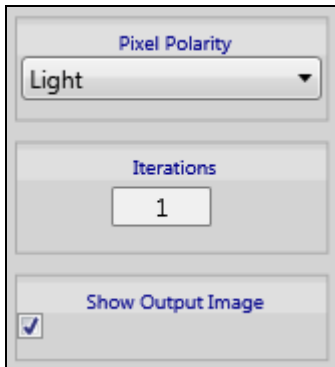

**Pixel Polarity** selects the color of the objects you want to separate. **Iterations** sets the number of times the operation is repeated on the image. The effect of the operation is increased as this value is increased. This parameter is defaulted to **1**, but you will typically need to increase the number of iterations to achieve the desired effect. **Show Output Image** is enabled by default. The pre-processed image will be shown within the ROI of your tool so you can see the effect of your chosen operation. You can use this option to hide the pre-processed image.

### Connect Objects (Close) Example:



*OCR Tool, dot matrix print, no image pre-processing, characters not well-segmented.*

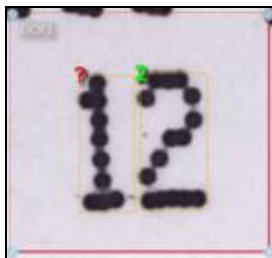

*OCR with Connect Objects (Close) enabled, Dark Pixels, 1 Iteration.*

## Shrink Objects (Erode)

**Shrink Objects (Erode)** uses morphological pre-processing to perform an **erode** operation. This decreases the size of objects. This operation is similar to Separate Objects in that it is typically used to separate objects that are touching. The difference is that the Separate Objects operation performs an erosion followed by a dilation, so that objects are separated but then returned to their original size. The Shrink Objects option only erodes objects. The editor options for this operation are the same as for Separate Objects.

**Pixel Polarity** selects the color of the objects you want to separate. **Iterations** sets the number of times the operation is repeated on the image. The effect of the operation is increased as this value is increased. This parameter is defaulted to **1**, but you will typically need to increase the number of iterations to achieve the desired effect. **Show Output Image** is enabled by default. The pre-processed image will be shown within the ROI of your tool so you can see the effect of your chosen operation. You can use this option to hide the pre-processed image.

### Shrink Objects (Erode) Example:

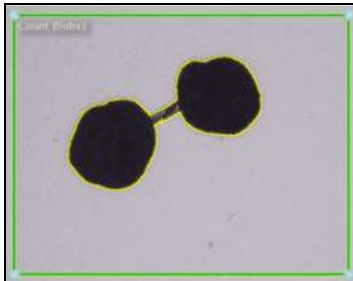

*Count Tool, no image pre-processing, two blobs connected and counted as one.*

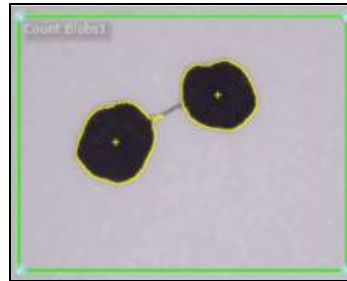

*Count Tool with Shrink Objects (Erode) enabled, Dark Pixels, 5 Iterations, counting two blobs.*

## Grow Objects (Dilate)

**Grow Objects (Dilate)** uses morphological pre-processing to perform a **dilate** operation. This increases the size of objects. This operation is similar to Connect Objects option in that it is typically used to connect objects. The difference is that the Connect Objects operation performs a dilation followed by an erosion, so that objects are connected but then returned to their original size. The Grow Objects option only dilates objects. The editor options for this operation are the same as for Connect Objects.

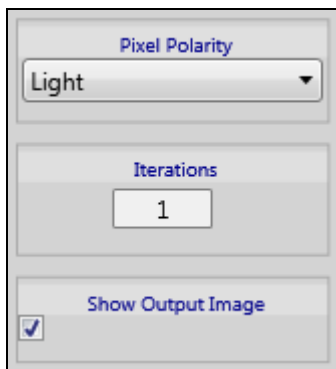

**Pixel Polarity** selects the color of the objects you want to separate. **Iterations** sets the number of times the operation is repeated on the image. The effect of the operation is increased as this value is increased. This parameter is defaulted to **1**, but you will typically need to increase the number of iterations to achieve the desired effect. **Show Output Image** is enabled by default. The pre-processed image will be shown within the ROI of your tool so you can see the effect of your chosen operation. You can use this option to hide the pre-processed image.

### Grow Objects (Dilate) Example:



OCR Tool, dot matrix print, no image pre-processing, characters not well-segmented.

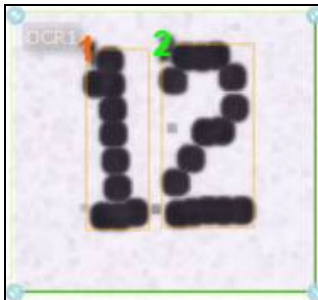

OCR with Grow Objects (Dilate) enabled, Dark Pixels, 1 Iteration.

## Gradient Image (Sobel)

**Gradient Image (Sobel)** performs a **Sobel** operation on the image, which highlights areas where there is contrast. The resulting image is dark where there is no contrast and light where there is contrast. This option is often used when trying to detect features in an area where illumination is uneven or inconsistent. Use this option with the Count Tool for applications in which trying to set a grayscale threshold is nearly impossible, and in which you need to detect objects based on their degree of contrast with the background.

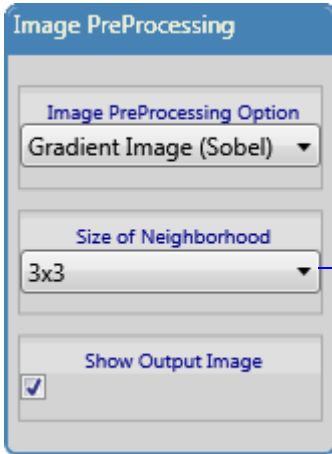

**Size of Neighborhood** refers to the size of the kernel that is used when calculating the contrast for each pixel within the image. Choose 3x3 to detect sharper contrast, and use 5x5 and 7x7 when trying to detect contrast that is more blurry, less sharp.

**Show Output Image** is enabled by default. The pre-processed image will be shown within the ROI (region of interest) of your tool so you can see the effect of your chosen operation. You can use this option to hide the pre-processed image.

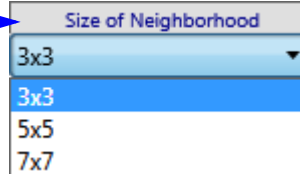

### Gradient Image (Sobel) Example:



*Count Tool (Blob Count) struggling to detect a subtle scratch on part.*

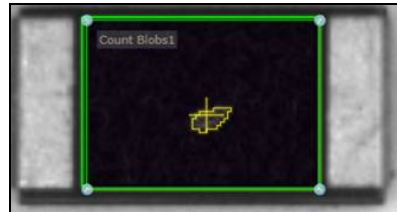

*Count Tool (Blob Count) with Gradient Image (Sobel) enabled, Light Pixels.*

## Smooth Noise (Mean Low Pass Filter)

This option smooths out background “noise” by softening image contrast via a weighted neighborhood average operation. It is typically used on specular, metallic backgrounds.

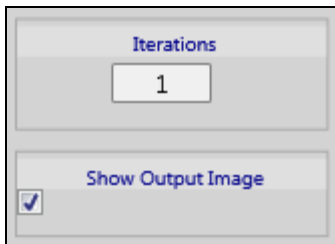

**Iterations** sets the number of times the operation is repeated on the image. The effect of the operation is increased as this value is increased. This parameter is defaulted to 1, but you will typically need to increase the number of iterations to achieve the desired effect.

**Show Output Image** is enabled by default. The pre-processed image will be shown within the ROI of your tool so you can see the effect of your chosen operation. You can use this option to hide the pre-processed image.

### Smooth Noise (Mean Low Pass Filter) Example:



*Count Tool (Blob Count) struggling to count features on a metallic surface.*

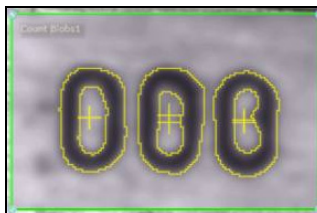

*Count Tool (Blob Count) with Smooth Noise (Mean Low Pass Filter) enabled, 10 Iterations.*

## Advanced Parameters

Most AutoVISION tools have an **Advanced Parameters** menu that allows you more granular control of tool functionality. Click the icon shown here to open the Advanced Parameters menu for any tool.



**Important:** If you are using a color camera, the Advanced Parameters dialogs will display a Color Channel dropdown menu at the top of the dialog as shown in the example below. **Luminance** is the default Color Channel value.

See the *Visionscape Tools Reference Manual* for more information about Color Channels.

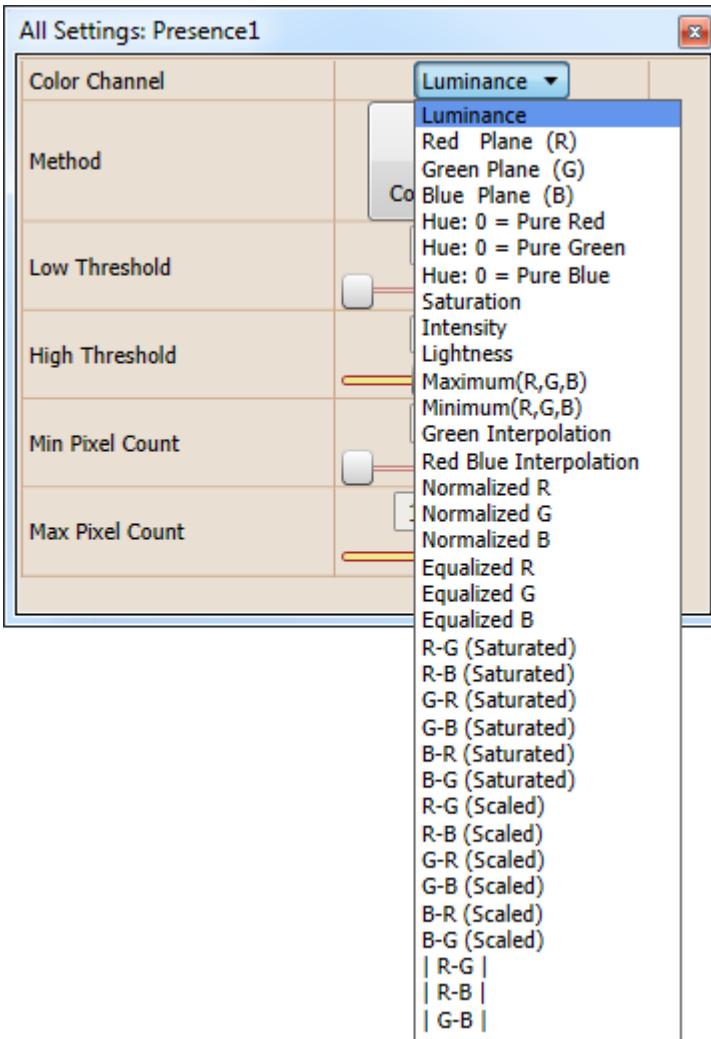

## Camera Advanced Parameters

All Settings: Camera	
Exposure	400 $\mu$ sec
Gain	1
Offset	0
Trigger	None
Trigger Polarity	Low->High
Trigger Delay	0
Lighting Mode	Off
Acquire Options	<input type="checkbox"/> Capture Laser Target <input type="checkbox"/> Lock Focus during Calibration <input type="checkbox"/> Lock Gain during Calibration <input type="checkbox"/> Lock Exposure during Calibration
Sensor Mode	Binning Zoomed

## Locate Tool (Locate Shape) Advanced Parameters

All Settings: Locate Shape1	
Effort Level	Normal
Positioning Accuracy	Normal
Enable Scale Search	<input type="checkbox"/>
Minimum Scale	0.850
Maximum Scale	1.150
Conformity Tolerance	6.000
Min % of Model Match	50
Model Name (read only)	Model1



## Locate Tool (Locate Blob) Advanced Parameters

All Settings: Locate Blobs1 ⌵

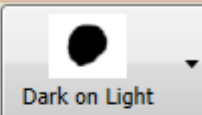





Polarity	 Dark on Light <span>⌵</span>
Ignore Blobs that Touch ROI	<input checked="" type="checkbox"/>
Min Blob Size	<input type="text" value="40"/> <span>⌵</span>
Max Blob Size	<input type="text" value="1000000"/> <span>⌵</span>
Auto Threshold	<input type="checkbox"/>
Threshold	<input type="text" value="65"/> <span>⌵</span>

## Decode Tool Advanced Parameters

All Settings: Decode1 ES

Symbology Types	<div style="border: 1px solid gray; padding: 2px;"> <ul style="list-style-type: none"> <li>Data Matrix ECC200</li> <li>Data Matrix NON-ECC200</li> <li>QR Code 2005</li> <li>Aztec Code</li> <li>Code 39</li> <li>Code 128</li> <li>BC412</li> <li>I2-5</li> <li>Codabar</li> <li>UPC/EAN</li> <li>Code 93</li> <li>Pharma Code</li> <li>GS1 DataBar</li> <li>Postal Symbologies</li> <li>PDF417/MicroPDF</li> <li>Composite</li> <li>DotCode</li> </ul> </div>
Match String Enable	<input type="checkbox"/> <span style="float: right;">🔗</span>
Match String	<input type="text"/> <span style="float: right;">🔗</span>
Wildcard Character	<input type="checkbox"/> <span style="float: right;">🔗</span>
Max Symbols	<input type="text" value="1"/> <span style="float: right;">🔗</span>
GS1 Validation	<input type="checkbox"/> <span style="float: right;">🔗</span>
Code128 Symbol Length	<input type="text" value="10"/> <span style="float: right;">🔗</span>
Timeout (ms)	<input type="text" value="10000.000"/> <span style="float: right;">🔗</span>
Linear Security Level (C128)	<input type="text" value="Aggressive"/> <span style="float: right;">🔗</span>
Damaged Mode (C39 C128 C93)	<input type="checkbox"/> <span style="float: right;">🔗</span>
Code128 Fixed Symbol Length Status	<input type="checkbox"/> <span style="float: right;">🔗</span>
Code128 EAN Status	<input type="checkbox"/> <span style="float: right;">🔗</span>
Code128 Output Format	<input type="text" value="Standard"/> <span style="float: right;">🔗</span>
Code128 Application Record Separator Status	<input type="checkbox"/> <span style="float: right;">🔗</span>
Code128 Application Record Separator Character	<input type="text"/> <span style="float: right;">🔗</span>
Code128 Application Record Brackets Status	<input type="checkbox"/> <span style="float: right;">🔗</span>
Code128 Application Record Padding Status	<input checked="" type="checkbox"/> <span style="float: right;">🔗</span>
Code39 Check Character Status	<input type="checkbox"/> <span style="float: right;">🔗</span>
Code39 Check Character Output Status	<input type="checkbox"/> <span style="float: right;">🔗</span>
Code39 Large Intercharacter Gap Status	<input type="checkbox"/> <span style="float: right;">🔗</span>
Code39 Fixed Symbol Length Status	<input type="checkbox"/> <span style="float: right;">🔗</span>
Code39 Symbol Length	<input type="text" value="10"/> <span style="float: right;">🔗</span>
Code39 Full ASCII Set Status	<input type="checkbox"/> <span style="float: right;">🔗</span>
I25 Check Character Status	<input type="checkbox"/> <span style="float: right;">🔗</span>
I25 Check Character Output Status	<input type="checkbox"/> <span style="float: right;">🔗</span>
I25 Symbol Length 1	<input type="text" value="16"/> <span style="float: right;">🔗</span>
I25 Symbol Length 2	<input type="text" value="6"/> <span style="float: right;">🔗</span>
I25 Guard Bar Status	<input type="checkbox"/> <span style="float: right;">🔗</span>
I25 Range Mode Status	<input checked="" type="checkbox"/> <span style="float: right;">🔗</span>
UPC/EAN EAN Status	<input checked="" type="checkbox"/> <span style="float: right;">🔗</span>
UPC/EAN Supplementals Status	<input type="text" value="Disabled"/> <span style="float: right;">🔗</span>
UPC/EAN Separator Status	<input type="checkbox"/> <span style="float: right;">🔗</span>
UPC/EAN Separator Character	<input type="text"/> <span style="float: right;">🔗</span>
UPC/EAN Supplementals Type	<input type="text" value="Both"/> <span style="float: right;">🔗</span>
UPC/EAN UPC-E as UPC-A Status	<input checked="" type="checkbox"/> <span style="float: right;">🔗</span>
Auto Teach Options	<div style="border: 1px solid gray; padding: 2px;"> <ul style="list-style-type: none"> <li>Train Step</li> <li>Learn Match String</li> </ul> </div> <span style="float: right;">🔗</span>
Train	<input type="button" value="Train"/>
Optimize	<input type="button" value="Optimize"/>

## OCR Tool (Standard OCR) Advanced Parameters

All Settings: OCR1		☒
Use Default Font	<input checked="" type="checkbox"/>	
Font		AV DEFAULT ▾
Confidence		0.500 
		
Auto Size	<input checked="" type="checkbox"/>	
Connection Strength		0 
		
Unknown Character		?
Multiline Separator		
Match String Enable	<input type="checkbox"/>	
Match String		
Min Character Area (pixels)		40 
Use Wildcard ? in Match String	<input type="checkbox"/>	
Auto Teach Options		<a href="#">Learn Match String</a>

## OCR Tool (IntelliText OCR) Advanced Parameters

All Settings: OCR1 ⌵

Use Default Font	<input checked="" type="checkbox"/>	<span>⌵</span>
Font	AV DEFAULT <span>▾</span>	
Confidence	0.800 <span>⌵</span>	<span>⌵</span>
Character Polarity	123 Dark Characters <span>▾</span>	<span>⌵</span>
Minimum Width	1 <span>⌵</span>	<span>⌵</span>
Maximum Width	200 <span>⌵</span>	<span>⌵</span>
Minimum Height	10 <span>⌵</span>	<span>⌵</span>
Maximum Height	200 <span>⌵</span>	<span>⌵</span>
Minimum Character Pixels	20 <span>⌵</span>	<span>⌵</span>
Scaling Factor	1.000 <span>⌵</span>	<span>⌵</span>
Unknown Character	? <span>⌵</span>	<span>⌵</span>
Multi-Line Separator	<span>⌵</span>	<span>⌵</span>
Binary Threshold Mode	Auto <span>▾</span>	<span>⌵</span>
Discard Boundary Characters	<input checked="" type="checkbox"/>	<span>⌵</span>
Character Slant Detection	<input checked="" type="checkbox"/>	<span>⌵</span>
Single Line Detection	<input type="checkbox"/>	<span>⌵</span>
Auto Teach Options	Learn Match String	
Match String	<span>⌵</span>	<span>⌵</span>
String Matching Method	Disabled <span>▾</span>	<span>⌵</span>

## Count Tool (Blob Count) Advanced Parameters

All Settings: Count Blobs1 ⊞

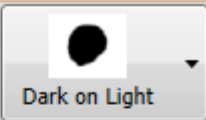
Polarity	 <span>⊞</span>
Ignore Blobs that Touch ROI	<input type="checkbox"/>
Min Blob Size	<input type="text" value="40"/> <span>⊞</span>
Max Blob Size	<input type="text" value="1000000"/> <span>⊞</span>
Auto Threshold	<input type="checkbox"/>
Threshold	<input type="text" value="100"/> <span>⊞</span>
Min Count	<input type="text" value="1"/> <span>⊞</span>
Max Count	<input type="text" value="4"/> <span>⊞</span>

## Count Tool (Shape Count) Advanced Parameters

All Settings: Count Shape1 ⊞

Effort Level	<input type="text" value="Normal"/> ▾
Positioning Accuracy	<input type="text" value="Normal"/> ▾
Enable Scale Search	<input type="checkbox"/>
Minimum Scale	<input type="text" value="0.850"/>
Maximum Scale	<input type="text" value="1.150"/>
Conformity Tolerance	<input type="text" value="6.000"/>
Min % of Model Match	<input type="text" value="90"/>
Model Name (read only)	<input type="text" value="Model1"/>

## Presence/Absence Tool Advanced Parameters

The screenshot shows a dialog box titled "All Settings: Presence1" with a close button in the top right corner. The dialog is divided into several rows, each representing a different parameter:





- Method:** A dropdown menu showing "Count Gray Pixels" with a small icon of a square with a green border and an orange triangle.
- Low Threshold:** A slider control with a value of "0" and a red link icon.
- High Threshold:** A slider control with a value of "80" and a red link icon.
- Min Pixel Count:** A slider control with a value of "40" and a red link icon.
- Max Pixel Count:** A slider control with a value of "10478576" and a red link icon.

## Measure Tool (Width) Advanced Parameters

The screenshot shows a dialog box titled "All Settings: Measure1" with a close button in the top right corner. The dialog is divided into several rows, each representing a different parameter:









- Measurement Direction:** A dropdown menu showing "Width Measurement" with a small icon of a horizontal line with an arrow pointing right.
- Polarity:** A dropdown menu showing "Light To Dark Edges" with a small icon of a horizontal line with an arrow pointing right.
- Sharpness:** A dropdown menu showing "Sharp Edges (+/-)" with a small icon of a horizontal line with a red 'X' in the center.
- Straightness:** A dropdown menu showing "Rough (+/- 2.75 pixels)" with a small icon of a wavy line with green 'X' marks.
- Threshold:** A text input field with a value of "30".
- Distance Type:** A dropdown menu showing "Point to Line Distance" with a small icon of a point and a line.
- Lower Tolerance:** A text input field with a value of "10.000".
- Upper Tolerance:** A text input field with a value of "80.000".

## Measure Tool (Height) Advanced Parameters

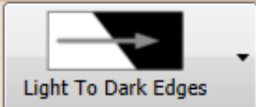
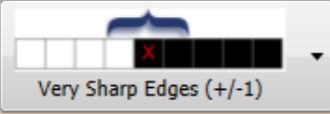
All Settings: Measure1		☒
Measurement Direction	Height Measurement ▾	
Polarity	 Light To Dark Edges ▾	
Sharpness	 Sharp Edges (+/-2) ▾	
Straightness	 Rough (+/- 2.75 pixels) ▾	
Threshold	30	
Distance Type	 Point to Line Distance ▾	
Lower Tolerance	10.000	
Upper Tolerance	80.000	







## Measure Tool (Circle) Advanced Parameters

All Settings: Circle1 ✖







Scan Direction	
Number of Vectors	<input type="text" value="30"/>
Edge Strength	<input type="text" value="30"/> 
Polarity	
Sharpness	 
Edge Point Selection	<input type="text" value="First"/>
Minimum Required Edge Points	<input type="text" value="5"/>
Circle Fit Precision	<input type="text" value="+/- 2.25 Medium/Rough Fit"/> 
Lower Tolerance	<input type="text" value="10.000"/> 
Upper Tolerance	<input type="text" value="400.000"/> 
Result Type	<input type="text" value="Transitions"/>
Maximum number of Transitions	<input type="text" value="10"/>
Graphics Level	<input type="text" value="Show Basic Graphics"/> 
Enable Radius Filter	<input type="checkbox"/>
Enable Location Filter	<input type="checkbox"/>
Circle Fit Method	<input type="text" value="Normal"/>
Circle Range Method	<input type="text" value="3PointGroups"/>
Circle Completeness	<input type="text" value="Don't Care"/>
Circle Calculations	<div style="border: 1px solid blue; background-color: #e6f2ff; padding: 5px;"> <ul style="list-style-type: none"> <li>Radius and Center Point</li> <li>FIT: Num Points Used in Fit</li> <li>FIT: Error (RMS deviation)</li> <li>FIT: Mean, Min, Max, Abs Deviations</li> <li>FIT: Furthest Points off Circle</li> <li>CANDIDATE: Mean, Min, Max, Abs Deviations</li> <li>CANDIDATE: Furthest Points off Circle</li> <li>FIT: Circle Point List</li> <li>FIT: Num Points Inside Circle Rejected</li> <li>FIT: Num Points Outside Circle Rejected</li> </ul> </div>









## Measure Tool (Point to Point) Advanced Parameters

All Settings: Pt to Pt1	
Input Point 1	 <Not Connected> 
Input Point 2	 <Not Connected> 
Lower Tolerance	<input type="text" value="10.000"/> 
Upper Tolerance	<input type="text" value="400.000"/> 

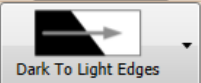

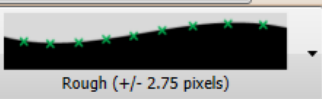

## Measure Tool (Point to Line) Advanced Parameters

All Settings: Pt to Line1	
Input Point	 <Not Connected> 
Input Line	 <Not Connected> 
Lower Tolerance	<input type="text" value="10.000"/> 
Upper Tolerance	<input type="text" value="400.000"/> 





## Measure Tool (Angle) Advanced Parameters

All Settings: Angle1	
Scan Direction	Top to Bottom 
Polarity	 Dark To Light Edges
Sharpness	 Sharp Edges (+/-2) 
Straightness	 Rough (+/- 2.75 pixels) 
Threshold	<input type="text" value="30"/> 
Nominal Angle	<input type="text" value="0.000"/> ° 
+/- Angle Tolerance	<input type="text" value="5.000"/> ° 

## Match Strings Tool Advanced Parameters

All Settings: MatchStrings1	
Input String 1	 <Not Connected> 
Input String 2	 <Not Connected> 
Good Match Text	Strings Match
Bad Match Text	Strings Don't Match!

## String Format Tool Advanced Parameters

All Settings: StringFormat1	
String 1	 <Not Connected> 
String 2	 <Not Connected> 
Optional Format	
Optional Format	

## OCV Tool Advanced Parameters

All Settings: OCV1	
AutoFind: Distance Tolerance	<input type="text" value="10.000"/> pixels
AutoFind Pin 1 Index	<input type="text" value="1"/>
AutoFind Pin 2 Index	<input type="text" value="999"/>
Individual Symbol Search X	<input type="text" value="3"/> pixels
Individual Symbol Search Y	<input type="text" value="3"/> pixels

## Symbol Quality Verification Tool (ISO15415) Advanced Parameters

All Settings: ISO15415 Tool1 ✖

Auto Aperture Size	<input type="text" value="50"/> %	
Lighting Wavelength	<input type="text" value="640"/>	
Lighting Angle	<input type="text" value="90"/>	
Setup Notes	<input type="text"/>	
Calibration Symbol 1 Dimension	<input type="text" value="0.240"/>	
Calibration Symbol 2 Dimension	<input type="text" value="0.480"/>	
Cal Target Rmin (%)	<input type="text" value="4.000"/> %	
Cal Target Rmax (%)	<input type="text" value="82.000"/> %	
Maximum Exposure	<input type="text" value="32000"/> us	

## Symbol Quality Verification Tool (AIMDPM/ISO29158) Advanced Parameters

All Settings: AIMDPM/ISO29158 Tool1 ✖

Dimension Units	<input type="text" value="mil"/>
-----------------	----------------------------------

## Symbol Quality Verification Tool (ISO15416) Advanced Parameters

All Settings: ISO15416 Tool1 ✖

Symbology Types	<ul style="list-style-type: none"> <li>Code 39</li> <li>Code 128</li> <li>I2-5</li> <li>UPC/EAN</li> <li>Code 93</li> <li>GS1 DataBar</li> </ul>	
Auto Aperture Size	<input type="text" value="50"/> %	
Lighting Wavelength	<input type="text" value="640"/>	
Lighting Angle	<input type="text" value="90"/>	
Setup Notes	<input type="text"/>	
Signal Compensation	<input type="checkbox"/>	
Calibration Symbol 1 Dimension	<input type="text" value="0.240"/>	
Calibration Symbol 2 Dimension	<input type="text" value="0.480"/>	
Cal Target Rmin (%)	<input type="text" value="4.000"/> %	
Cal Target Rmax (%)	<input type="text" value="82.000"/> %	
Maximum Exposure	<input type="text" value="32000"/> us	

# Camera

Camera parameters can be used to set up image acquisition.

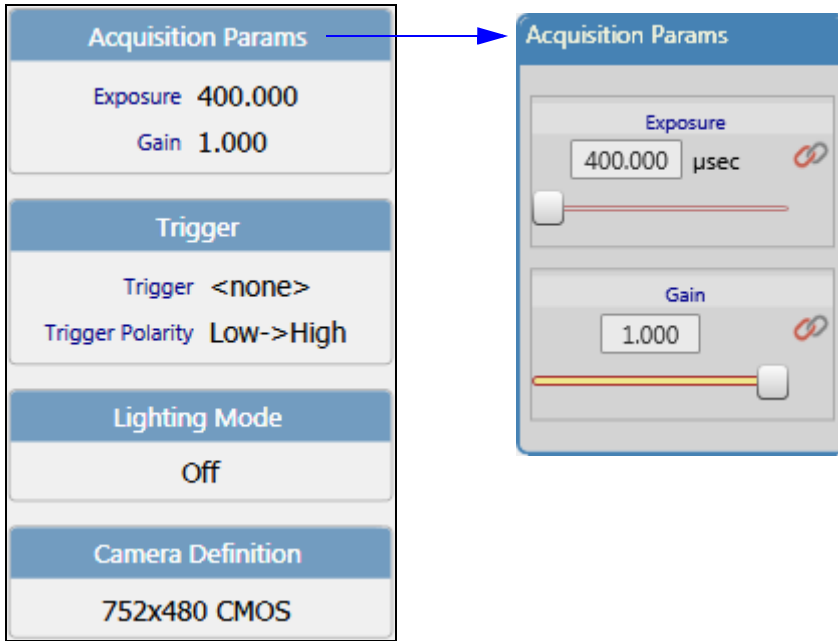

- When connected to a smart camera, adjust camera-specific settings such as **Exposure**, **Gain**, **Focus**, **Trigger**, and **Lighting Mode**.
- When using the Emulator, select your image file location on the PC and use the **Camera Definition** menu to select which smart camera and resolution to emulate.

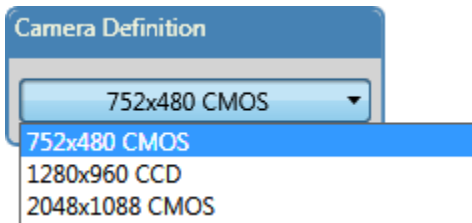

## Trigger

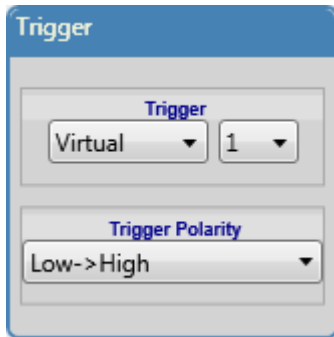

- Use the **Trigger** dropdown menu to adjust trigger input settings.

**None:** Continuous operation; no trigger defined.

**Digital:** Select from available digital inputs on the camera.

**Virtual:** Select virtual triggers 1 through 10.

**Sensor:** The sensor input of the camera will trigger.

**Serial Trigger:** A programmable serial command can be sent over a programmable port. The text field to the right of the Trigger dropdown menu accepts the following special non-printable characters:

**\a** bell

**\b** backspace

**\f** form feed

**\n** new line

**\r** carriage return

**\t** horizontal tab

**\v** vertical tab

**\'** single quote

**\x022** double quote ( " )

**\?** question mark

**\ooo** three digit octal notation ASCII value, i.e. **\145** = 'e'

**\x0hh** hexadecimal notation ASCII value, i.e. **\0x04C** = 'L'

## Force Trigger

When a trigger is selected and **Wait for Triggers During Acquire and Tryout** is selected, the **Force Trigger** button will appear above the Navigator Bar. This allows you to trigger the camera to acquire images and advance the Tryout Loop.

**Important:** Triggering from AutoVISION is intended for testing only and results in significant processing time variation. Use the actual trigger source for actual timing values.

### Trigger Dropdown Menu

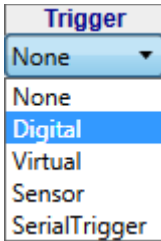

### Wait for Triggers During Acquire and Tryout



### Force Trigger Button

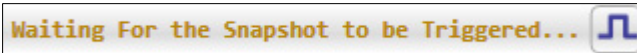

## Trigger Polarity

Trigger Polarity allows you to set whether the trigger is **Low > High** or **High > Low**.

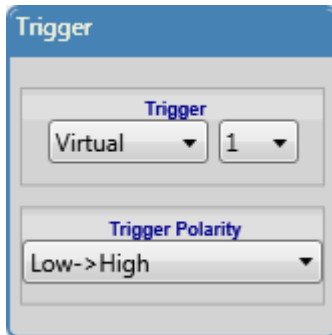

## Focus

The **Focus** control slider allows you to set the focus of the camera's built-in lens system.

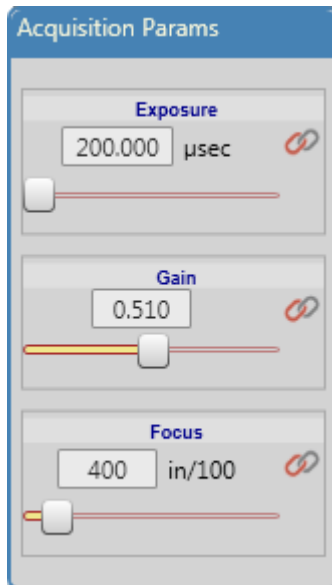

## Lighting

Allows you to select between **Off**, **On**, **Strobe**, **Power Strobe**, or **External Strobe**. Power Strobe mode is limited to a maximum **1 ms** pulse width (as with Omron Microscan's NERLITE Smart Series Illuminators).

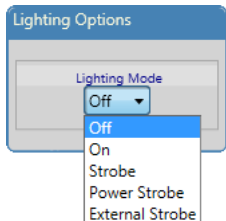

When Lighting is set to **Off**, external lighting is disabled, and internal lighting is turned off.

When Lighting is set to **On**, external lighting is enabled (Output 3 is placed in a de-energized or open state) and internal lighting is enabled.

When Lighting is set to **Strobe**, Output 3 is enabled to control an external light. The normal state for Output 3 in this configuration is in an energized or closed state. At the start of an image acquisition the output is de-energized or placed in an open state. At the end of the camera's exposure period, the output is set back to a closed state. Strobe operation allows you to connect the appropriate NERLITE external lighting product for your application and to control that light in sync with image acquisition. The light can be switched on fast enough that it is at full brightness before the exposure begins.

**Power Strobe and External Strobe** allow you to select different lighting configurations when acquiring an image.

**Note:** Power Strobe does not function with rolling shutter.

**Lighting Select** allows you to select between Internal WHT, Internal RED, or Expansion lighting. This setting is used in conjunction with the Lighting Mode selection.

**External Strobe Control** allows you to select which output is used to control the External Strobe. The selected output is no longer available for use elsewhere in the job.

**Note:** There are no outputs available for MV-20.

### Lighting Mode Table

Light Mode Table	Inner LEDs	Outer LEDs	Off	On	Strobe	Power Strobe		External Strobe
						Inner LEDs	Outer LEDs	
Engine USB Power	Yes	No	Yes	Yes	Yes	No	N/A	Yes
Engine Ext Power	Yes	No	Yes	Yes	Yes	No	N/A	Yes*
MV-20	Yes	No	Yes	Yes	Yes	No	N/A	No
MV-20 Color	Yes	No	Yes	Yes	Yes	No	N/A	No
MV-30 USB Power	Yes	Yes	Yes	Yes	Yes	No	No	Yes**
MV-30 External Power	Yes	Yes	Yes	Yes	Yes	No	Yes	Yes
MV-30 Color	Yes	Yes	Yes	Yes	Yes	No	Yes	Yes
MV-40	Yes	Yes	Yes	Yes	Yes	No	Yes	Yes
MV-40 Color	Yes	Yes	Yes	Yes	Yes	No	Yes	Yes

\* If using breakout cable for engine

\*\* If using correct accessory breakout cable

See the *Visionscape Tools Reference Manual* for more information about lighting modes.



## Zooming and Binning







**Important:** Zooming and Binning functionality is available for SXGA cameras only.

The **Zoomed** and **Binning** options, available in the **Sensor Mode** section of the camera's **Advanced Parameters** menu, allow you to change how images are acquired in order to increase capture rate (Zoomed) or improve the signal-to-noise ratio (Binning).

Zoomed provides a quarter-resolution centered partial-scan image. This image has a smaller field of view than the default full-scan image.

Binning provides a quarter-resolution full-scan image with the same field of view and capture rate as a full-scan image. The reduction in total pixels reduces image resolution.

### Advanced Camera Parameters:

All Settings: Camera	
Exposure	400 $\mu$ sec 
Gain	1 
Offset	0
Trigger	None 
Trigger Polarity	Low->High 
Trigger Delay	0 
Lighting Mode	Off 
Acquire Options	<ul style="list-style-type: none"> <li>Capture Laser Target</li> <li>Lock Focus during Calibration</li> <li>Lock Gain during Calibration</li> <li>Lock Exposure during Calibration</li> </ul>
Sensor Mode	Binning  Zoomed

# Locate Tool



The **Locate Tool** dynamically locates a learned pattern within a captured image. This tool:

- Learns a pattern based on edges.
- Reports X, Y, and rotation coordinates of the edge pattern.
- Reports feature coordinates to locate other tools.
- Has a **template ROI (region of interest)** and a **locate ROI**.
- Can also be used for presence/absence inspection.

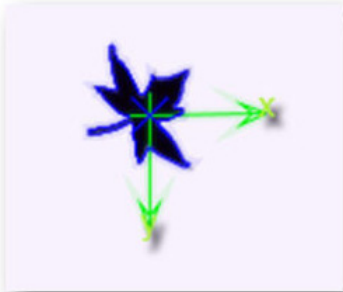

The **Locate Tool** locates features based on edges.

## Setting Up the Locate Tool

- Add the **Locate Tool** to the image area.
- Adjust the **template ROI** around the feature that you want the tool to learn.
- Adjust the **locate ROI** to cover the area within which you expect your feature to move from image to image. For best results, make this ROI as large as possible.
- Train the tool to recognize the pattern by clicking the **Train** icon.

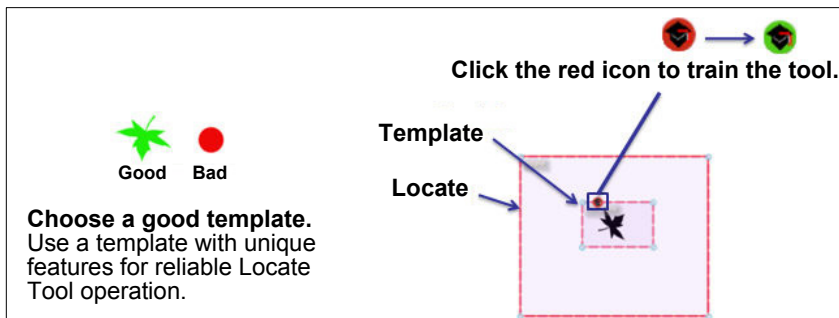

## Locate Tool Parameters

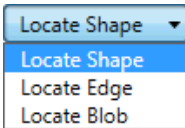

### Locate Shape

- **Quick Find:** Uses a rough location. Faster but less accurate.
- **Fit Quality:** Defines how closely the identified feature must match the template (**Relaxed, Normal, Precise**).
- **Accept Threshold:** A ratio that determines how well the located feature must match the trained feature. (**0.1 – 1**, where **1** = perfect match.)

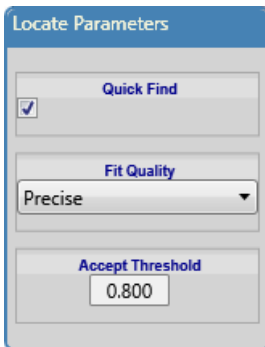

- **Allowed Rotation:** Sets a limit on how much the object can rotate and still be recognized.

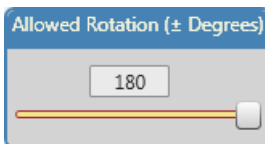

**Hint:** The **Locate Tool** is configured to handle 360 degrees of rotation by default. However, reducing the **Allowed Rotation (± Degrees)** will speed up the tool's performance considerably.

### Locate Edge

Finds an edge. This allows you to find reference lines and points that can be tied to the new Point to Point or Point to Line distance measurements. This also allows you to use the edge of an object as a locate feature, so that other tools can be offset based on the movement of that edge.

### Locate Blob

Finds a blob. This allows you to use a blob as the locate feature for other tools. It outputs the center point of the located blob, which can then be used along with the new Point to Point or Point to Line distance measurements.

## Multiple Locators

AutoVISION allows the use of multiple Locate Tools. If a second locator is inserted into the job, it will locate any of the tools inserted after it. Cascading location is also possible, meaning that the second locator can be offset by the first. To make it clear which locator is moving which tool, the color of the location icon is changed, and an index value is assigned to each locator.

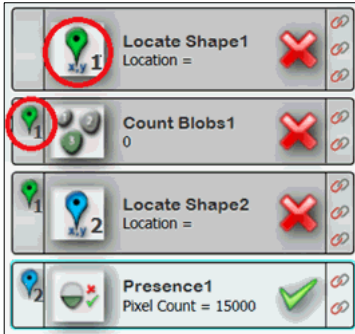

The first locator uses the green icon:



It also displays the digit '1' to indicate that this is the first locator. In this example, the Count Tool also displays a green locate icon with the digit '1' in the left-most locator column. This indicates that the Count Tool is located by the first locator.

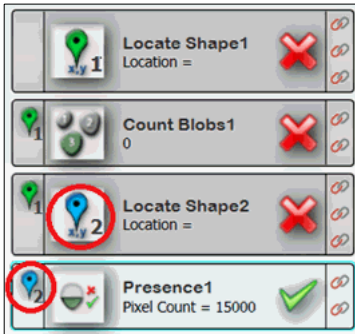

The second locator uses a blue icon and displays the digit '2' to indicate that it is the second locator. The Presence/Absence Tool also displays the blue icon with the digit '2', indicating that it is located by the second locator. The second locator is also being offset by the first locator, meaning that cascading location is in effect.

If you insert a third locator, the icon will be yellow, and in the unlikely instance that you want to use four or more locators, the colors will start over at green again.

If you disable location for the second locator, then all tools that follow it should be moved into the locate list of the first locator.

# Decode Tool



The **Decode Tool** uses Omron Microscan's aggressive X-Mode algorithms to decode 1D and 2D symbols. Up to 100 symbols can be decoded in a single region of interest. The Decode Tool also features a **Match String** function that allows you to specify the string that must be matched for the Decode Tool to pass.

**The Decode Tool supports the following:**

**All standard barcodes**



**GS1 DataBar**



**PDF417**



**Data Matrix, Aztec, QR**



**DotCode**



**DPM decoding**



**Omnidirectional decoding**



The Decode Tool can also read damaged or obstructed symbols as in the example below.

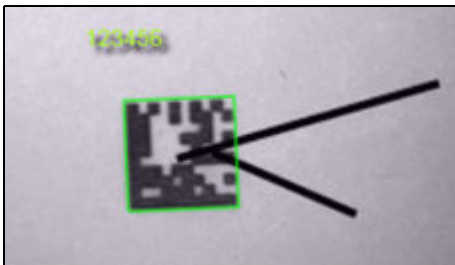

## Decode Tool Parameters

- Adjust ROI (region of interest) to at least 2 times the symbol size.
- Leave at least 2x the symbol's element size between the ROI and the symbol.
- Disable unused symbologies to reduce decode times.

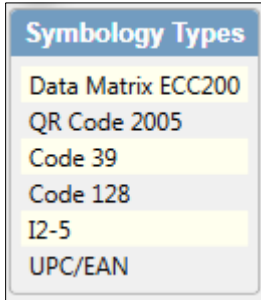

**Note:** DotCode cannot be decoded at the same time as other symbologies. If your application requires the decoding of DotCode symbols, enable DotCode only.

- Set the maximum number of symbols and multisymbol separator as needed.

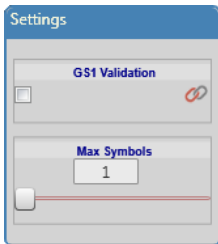

- Enter the Match String value if required.

## Decode Tool Match String

**Match String** allows you to specify the string that must be matched for the Decode Tool to pass. The Match String function for the Decode Tool allows you to enter a '?' character as a wildcard character.

## Non-Printable Characters

When a decoded symbol contains non-printable characters, the Match String can accept hexadecimal escape codes. These are of the form `\xFF`, where **FF** represents two hexadecimal digits. The "x" and the hex digits are not case sensitive.

To be processed, the escape sequence must be fully formed; otherwise it is treated as if it were not an escape sequence.

For example, to match **ABCD<cr>EFG**, where **<cr>** is a carriage return (**hex 0D**), set Match String to:

**ABCD\x0DEFG**

Using a serial command, this would be:

**SET matchstring1 ABCD\x0DEFG**

## Train and Optimize

Train	<input type="button" value="Train"/>
Optimize	<input type="button" value="Optimize"/>

### **Train**

The **Train** button in [Decode Tool Advanced Parameters](#) saves information relevant to the target symbol (if decoded) to allow higher readability for subsequent similar symbols. This mode of operation remains active until the call is made to disable it and revert to normal operation. Note that it un-optimizes the system once the system is trained. You can subsequently attempt to optimize the system after being trained.

### **Optimize**

The **Optimize** button saves information relevant to the target symbol (if decoded) to allow quicker reading and greater consistency for subsequent similar symbols. This mode of operation remains active until the call is made to disable it and revert to normal operation. Note that it disables all symbologies other than the one that has been optimized.

## GS1 Validation

**GS1 Validation** allows you to output separate GS1 application identifiers such as GTIN, batch or lot number, expiration date, and serial number. GS1 Validation also checks the syntax of the symbol for conformance to the GS1 standard.



Omron Microscan is a GS1 Solution Partner with a Certified GS1 Bar Code Professional on staff. This allows us to provide you with the background knowledge necessary to implement GS1 Standards successfully in your application.

Visit [www.gs1us.org](http://www.gs1us.org) for more information about why to use a GS1 Solution Partner.

To enable GS1 Validation, click the GS1 Validation box in the Decode Tool Settings editor.



The example below shows the Decode Tool's output broken into individual GS1 App IDs.

Notice the additional Omron Microscan Link output options that appear when GS1 Validation is enabled.

The GS1 App ID fields can then be output separately as TCP/IP Output values or selected by the Match String Tool.

## App IDs

App ID output parameters are added to the Decode Tool when a GS1 symbol is decoded, and they are not automatically removed when subsequent GS1 symbols are decoded. Additional App IDs from subsequent decoded GS1 symbols are appended to the original App ID output parameters to preserve any Omron Microscan Link connections that may have been made to those parameters.

Disabling GS1 Validation clears App ID output parameters. This is useful for clearing App IDs in applications requiring that a large number of different GS1 symbols be decoded.



# OCR Tool



The **OCR Tool** reads printed text and translates it to ASCII text. This tool:

- Reads multiple lines of text in a single ROI (region of interest).
- Features pre-loaded OCR fonts that are designed to be read without the need for training.
- Features user-trained fonts for more robust character recognition.
- Uses a multi-neural network model to allow greater character variation.
- Features **Image Pre-Processing**, which makes it easier for the tool to recognize and read characters in an image.

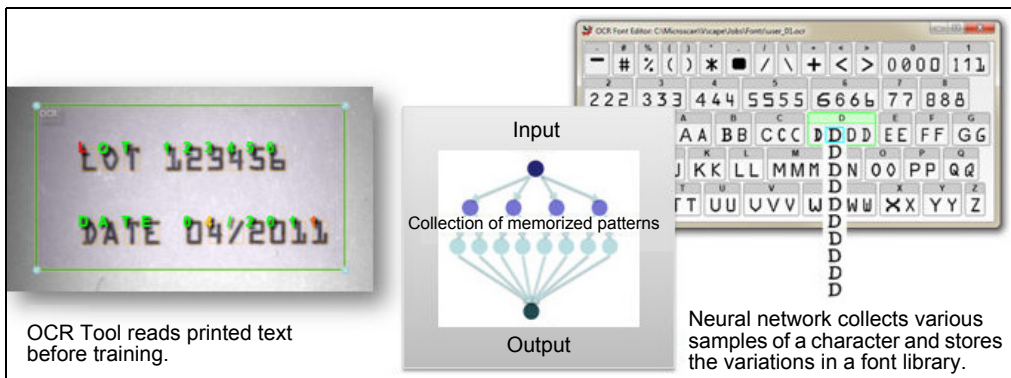

The OCR Tool has a **Standard OCR** capability and an **IntelliText OCR** capability. Select Standard OCR or IntelliText OCR from the dropdown menu above the tool parameters.

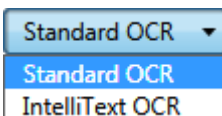

**Standard OCR** is sufficient for most applications, and offers font selection and editing, the ability to create new fonts, user-definable text reading confidence, auto-sizing or character selection based on width, height, and connection strength, and match string functionality.

**IntelliText OCR** offers most features of the standard algorithm plus the ability to set character polarity, use regular expression syntax in Match String, and perform image binarization. Use IntelliText OCR for symbols that are badly printed or marked. The IntelliText OCR algorithm is optimized for identification of characters that are tilted, out of scale, badly segmented, or otherwise difficult to read with the standard algorithm.

**Important:** When switching between Standard OCR and IntelliText OCR, the links between tool outputs and GDS tags are lost. This is because the underlying components that make up the OCR Tool are completely removed and then recreated whenever you change the tool's capability.

# OCR Tool Parameters

## Standard OCR Parameters



- **Font Selection:** Allows you to select the font to use, to create a new font, or to edit the current font library. New fonts are created from existing font libraries.
- **Confidence:** Allows you to specify the minimum level of character identification confidence required before a character will be read and output.
- **Character Selection:** Allows you to specify the **width** and **height** of a character (in pixels) or use **Auto Size**. Disable Auto Size for more reliable reading.  
**Connection Strength** helps correct for characters that are either touching or are formed by individual dots such as those produced by a dot pen stylus or inkjet printing. This parameter ranges from **-3** (AutoVISION will search for characters that are underprinted or not touching) to **3** (AutoVISION will search for characters that are overprinted or touching). When set to **0**, AutoVISION does not perform any pre-processing (multiple passes of an "erode" function for **-3**, **-2**, and **-1** or multiple passes of a "dilate" function for **1**, **2**, and **3**), so processing time will be decreased.
- **Match String:** Allows you to specify the string that must be matched for the OCR Tool to pass.
- **Image Pre-Processing:** Makes it easier for the tool to recognize and read characters in an image.
- **Enable ROI (Region of Interest) Rotation:** The OCR Tool can be enabled for ROI rotation by clicking the rotation icon at the upper left of the parameters view.

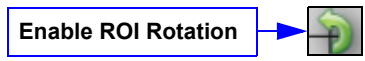

## IntelliText OCR Parameters

Font Selection

Current Font  
AV DEFAULT

Font Editor... New Font...

Character Selection

Confidence 0.800

Character Polarity 123  
Dark Characters

Min/Max Character Size

200  
10

8

1 200

Match String

Image Binarization

Binary Threshold Mode Fixed Template

Binarization Mean Factor 0.239

Binarization Dynamic Range 0.500

Image PreProcessing

Image PreProcessing Option <none>

Click the **Character Selection** area to open the Character Selection editor, where you can set read confidence, character polarity, and min./max. character height and width.

Character Selection

Confidence

0.800

Character Polarity

123  
Dark Characters

Minimum Height 10 Maximum Height 200

Minimum Width 1 Maximum Width 200

- **Font Selection:** Allows you to select the font to use, to create a new font, or to edit the current font library. New fonts are created from existing font libraries.
- **Character Selection:** Allows you to specify character requirements in multiple ways – **Confidence**, **Character Polarity**, **Min./Max. Height**, and **Min./Max. Width**.
  - Confidence:** Allows you to specify the minimum level of character identification confidence required before a character will be read and output.
  - Character Polarity:** Allows you so specify Dark Characters – black characters on a white background – and Light Characters – white characters on a black background.
  - Min./Max. Character Size:** Allows you to configure minimum and maximum character width and the minimum and maximum character height limits.
- **Match String:** Allows you to specify the string that must be matched for the OCR Tool to pass.
- **Image Binarization:** Converts grayscale images to black and white (binary) to optimize the readability of poorly segmented characters.
- **Image Pre-Processing:** Makes it easier for the tool to recognize and read characters in an image.
- **Enable ROI (Region of Interest) Rotation:** The OCR Tool can be enabled for ROI rotation by clicking the rotation icon at the upper left of the parameters view.

Enable ROI Rotation



## Font Editor

The **Font Editor** allows you to:

- View a character set
- Remove trained samples
- View default sample set characters
- View user-defined characters

Click the **Font Editor** button in the OCR tool parameters to bring up the Font Editor.

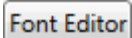

Default characters are highlighted in gray, and user-trained characters are highlighted in green.



When **Use Default Font** is unchecked in OCR Advanced Parameters, the Font Editor shows only user-trained characters.

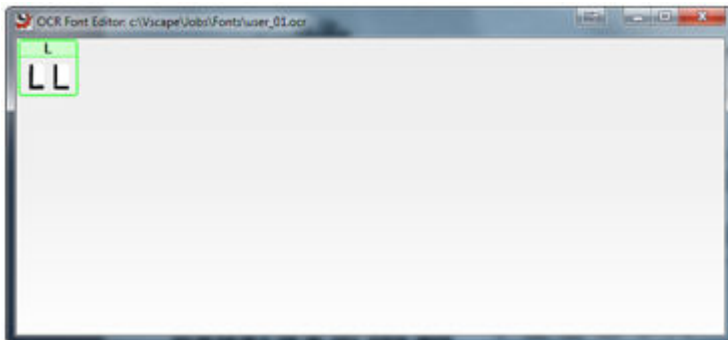

## Adding a New Font

When adding a new font to AutoVISION's font library, it is only necessary to include the characters that will be used. The new characters will be added to a new font based on an existing font.

For example, if you want to add parentheses to a number library so that parentheses will be identified correctly, right-click on the character that you want to add to the library, enter it in the **Character read as** text field, and then click the **Add Sample** button.

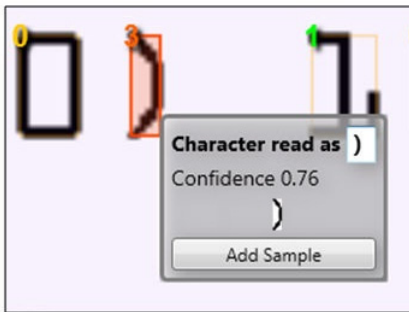

New ("user") fonts are based on existing ("default") fonts. Fonts can be named by clicking the **New Font** button and then entering the new font name in the **Font Name** text field.

New Font

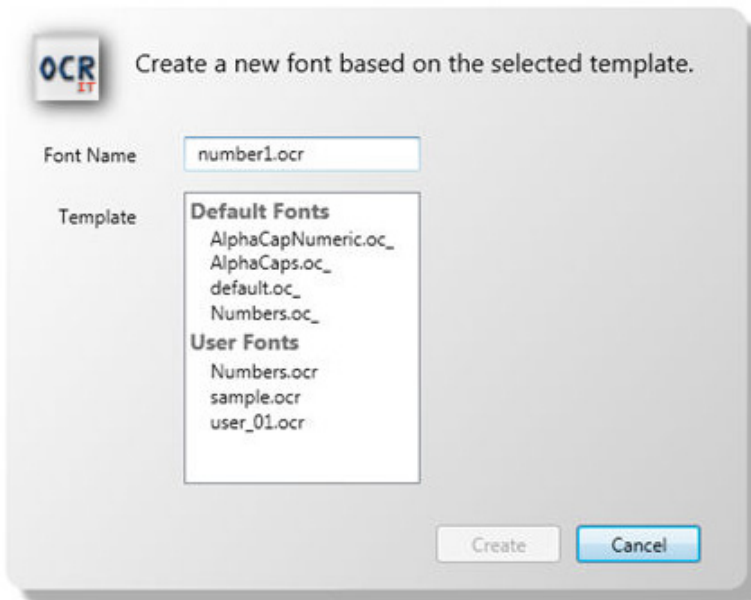

## Removing Multiple Character Samples Simultaneously for User-Trained Characters

When you train a new OCR character, multiple samples are added to the font library. If you add a new character accidentally, you can remove all user-trained samples for that character simultaneously.

Hovering over the first character position in a font entry shows the popup list of trained symbols. A red **X** button will appear at the top of the column of symbols. Pressing this button will remove all the user-trained data from the selected character.

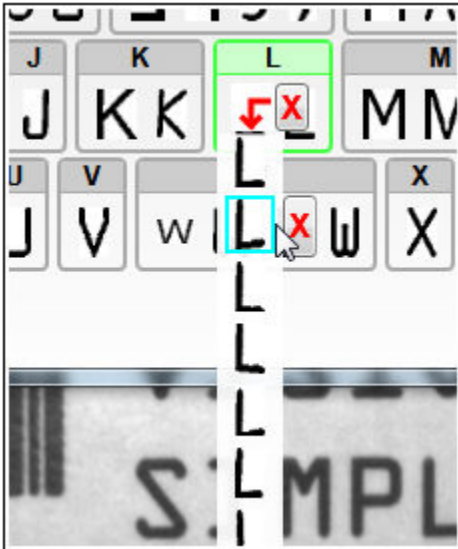

## Non-Printable Characters

When an OCR string contains non-printable characters, the Match String can accept hexadecimal escape codes. These are of the form `\xFF`, where **FF** represents two hexadecimal digits. The "x" and the hex digits are not case-sensitive.

To be processed, the escape sequence must be fully formed; otherwise it is treated as if it were not an escape sequence.

For example, to match **ABCD<cr>EFG**, where **<cr>** is a carriage return (hex **0D**), set Match String to:

**ABCD\x0DEFG**

Using a serial command, this would be:

**SET matchstring1 ABCD\x0DEFG**

## OCR Confidence

- The decoded ASCII text is placed over the printed text in the image.
- The color of the ASCII text character represents the confidence level with which it was recognized.
  - **Green:** ~80 – 100%
  - **Orange:** ~60 – 79%
  - **Red:** < 60%
- Click on any character to:
  - View confidence level
  - Add a sample to the character library
  - View a reference image

When a character is first added to the library, the original image is modified and variations of the character are also added. When samples for a given character already exist, samples up to a maximum of 10 are added. A replacement method is used to maintain the best statistical variety of samples for training.

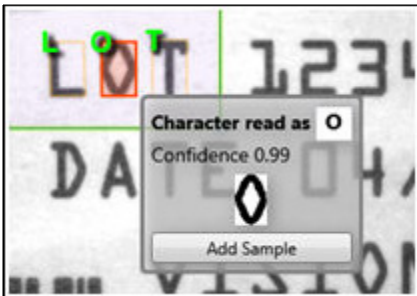

## OCR Tool Match String

**OCR Tool Match String** allows you to specify the string that must be matched for the OCR Tool to pass. OCR Match String allows you to enter a ‘?’ character as a wildcard character.

With **IntelliText OCR**, you can also create a variable match string using **regular expressions**.

When **String Matching Method** is set to **Basic**, basic string matching will be performed on the result string.

When it is set to **Regular Expression (TRE)**, the result string will be tested against the user-defined regular expression in the match string field.

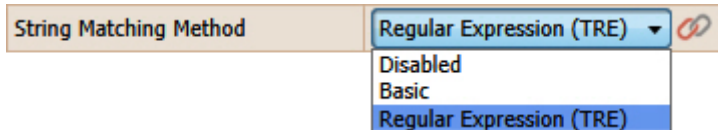

Regular expression syntax can be found here:

<http://laurikari.net/tre/documentation/regex-syntax/>.

### Regular Expression Examples

Example expiration date string matching “**EXP (JUN|FEB) [0-9]{2} [0-9]{4}**”:

“EXP JUN 12 1998” - **match**

“EXP JUN 30 1999” - **match**

“EXP FEB 12 1998” - **match**

“EXP JVN 12 1998” - **fail**

“EXP JUN 12 98” - **fail**

“EXP JUN 12 199B” - **fail**

“LXP JUN 12 1998” - **fail**

Example date string matching “**(0[1-9]|[12][0-9]|3[01])/(0[1-9]|1[012])/11**”:

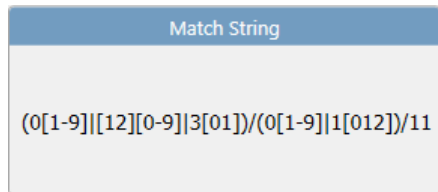

**(0[1-9]|[12][0-9]|3[01])** matches **01** to **31** only.

Read as:

**0** followed by **1** through **9** (**01-09**) **OR**

**1** or **2** followed by **0** through **9** (**10-29**) **OR**

**3** followed by **0** or **1** (**30-31**)

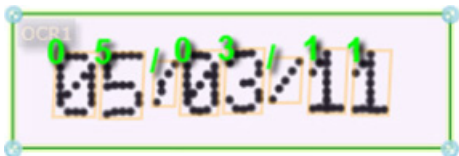

**Example result**



## Image Binarization

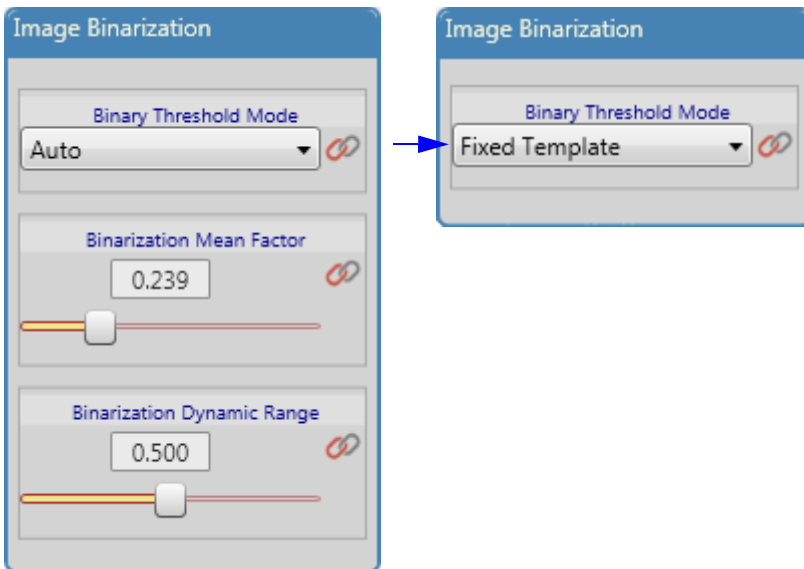
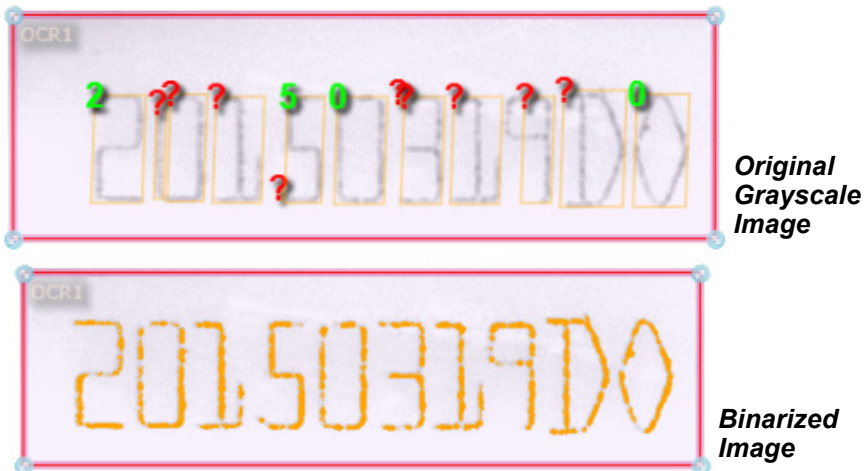

Image binarization, available in IntelliText OCR only, converts grayscale images to black and white (binary) to optimize the readability of poorly segmented characters.

The **Auto** setting is satisfactory for most applications.

**Fixed Template** allows nuanced control of binarization parameters.

In the example below, multiple characters are not detected when Image Binarization is set to **Auto**. When Image Binarization is set to **Fixed Template**, the cause of the segmentation problem is revealed to be poor binarization in the original grayscale image.



### IntelliText OCR Image Binarization – Example 1



**Binarization Mean Factor:**  
Lower from **0.5** until image noise begins to appear.



**Binarization Mean Factor:**  
Increase slightly until most of the noise disappears.



**Binarization Dynamic Range:**  
Lower from **0.5** to increase the thickness of the characters until image noise begins to appear.



**Binarization Dynamic Range:**  
Increase slightly until most of the noise disappears.



**Resize the ROI:** This switches the view back to the grayscale image to show corrected segmentation.



**Character Size:** Adjust width, height, and scale to improve segmentation further.

## IntelliText OCR Image Binarization – Example 2

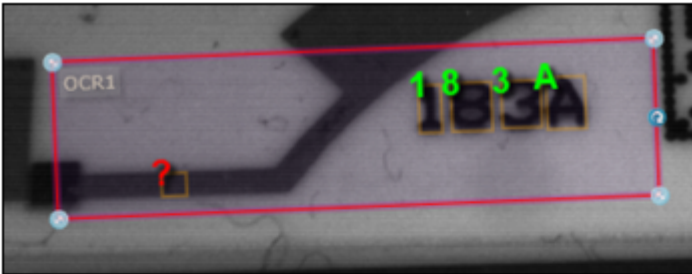

**Binarization Example:**  
Artifact causes an extra character to be detected.

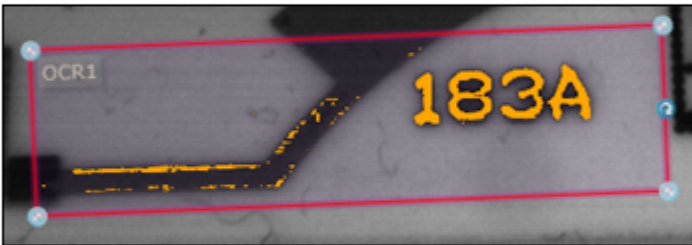

**Binarization:**  
Shows the source of the problem.

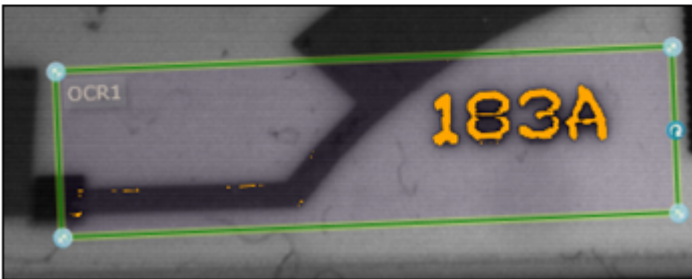

**Binarization Dynamic:**  
Adjust fixed values to eliminate image noise.

## Scaling Factor

The **Scaling Factor** parameter allows you to increase or decrease the number of pixels for IntelliText OCR to process in a given OCR character. This parameter is used to change the sampling interval of the ROI (region of interest).

IntelliText OCR is optimized for detecting characters in the range of **25-50 pixels in height**. Optimal character width is **30 pixels**. If your application requires the reading of text at high resolution, particularly high resolution dot print, this parameter can improve character detection by reducing character scale.

Because reducing the sampling introduces some loss of information, you may need to configure the optical setup accordingly. Scaling provides some speed enhancements when using larger ROIs and relatively low character counts.



### Scaling Factor Decrease – Example 1

The large dot mark in this example has excellent contrast and does not require optimization using binarization, but it does have segmentation problems. This particular mark is **130 pixels high**, which causes the text segmentation not to identify entire characters properly. By reducing the scaling to **0.5**, the character height is reduced to **65 pixels** and proper segmentation becomes possible. Note, however, that a symbol such as this should be captured at a lower resolution for optimal performance.

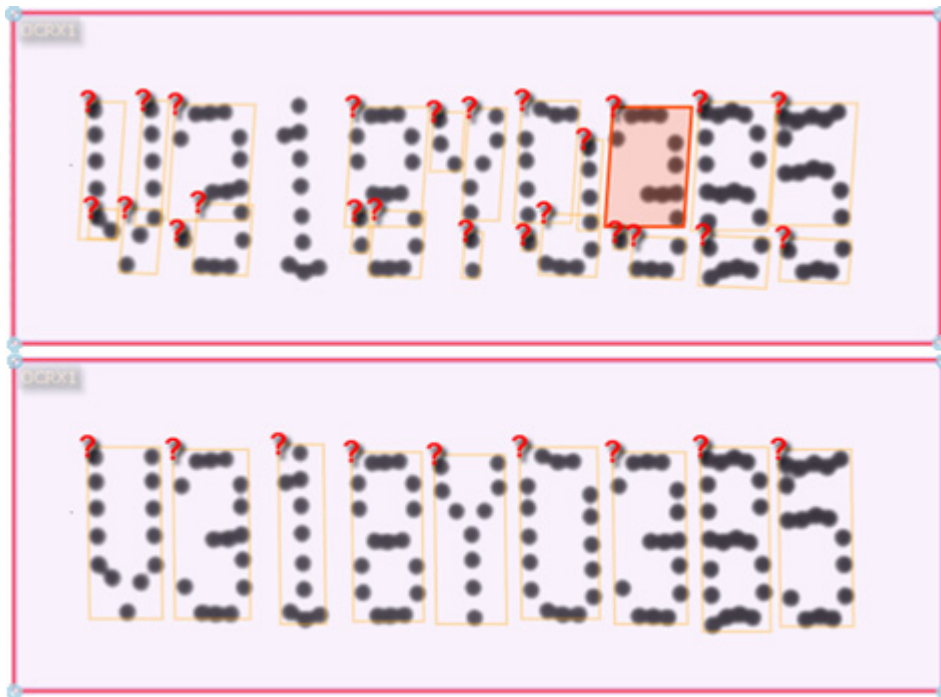

### Scaling Factor Decrease – Example 2

The following large mark shows image noise and a wide dynamic change across the ROI. The automatic binarization selection works well, but the low signal-to-noise ratio on the left side of the mark causes the **C** to fail. This could be optimized by fixing the binarization.



As this mark is approximately **80 pixels high**, it is rather large for optimum text segmentation. Because the mark is so large, the algorithm has detected segments from the **C** on different lines of characters.

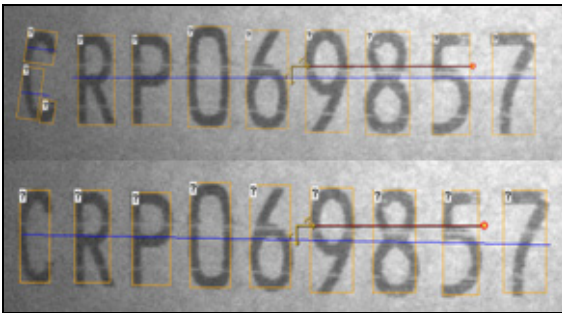

The segmentation problem is resolved by modifying scaling. This low-contrast mark may experience some instability from image to image with binarization set to **Auto**, and would likely benefit from a **Fixed Template** setting.

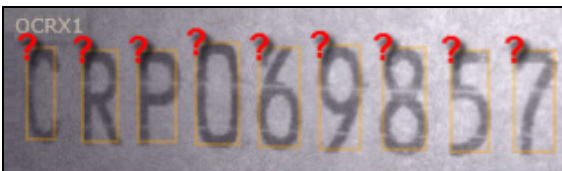

### Scaling Factor Increase Example

In the following example, the dot mark has close characters and partially touching characters. The mark is at reasonable resolution but the close characters are creating segmentation problems. Character thresholds can be modified to separate them, but this can be challenging, particularly in the **JUN** segment. Setting the scaling to **2.0** and over-exposing the image creates a good separation that binarizes well and subsequently segments properly and consistently.

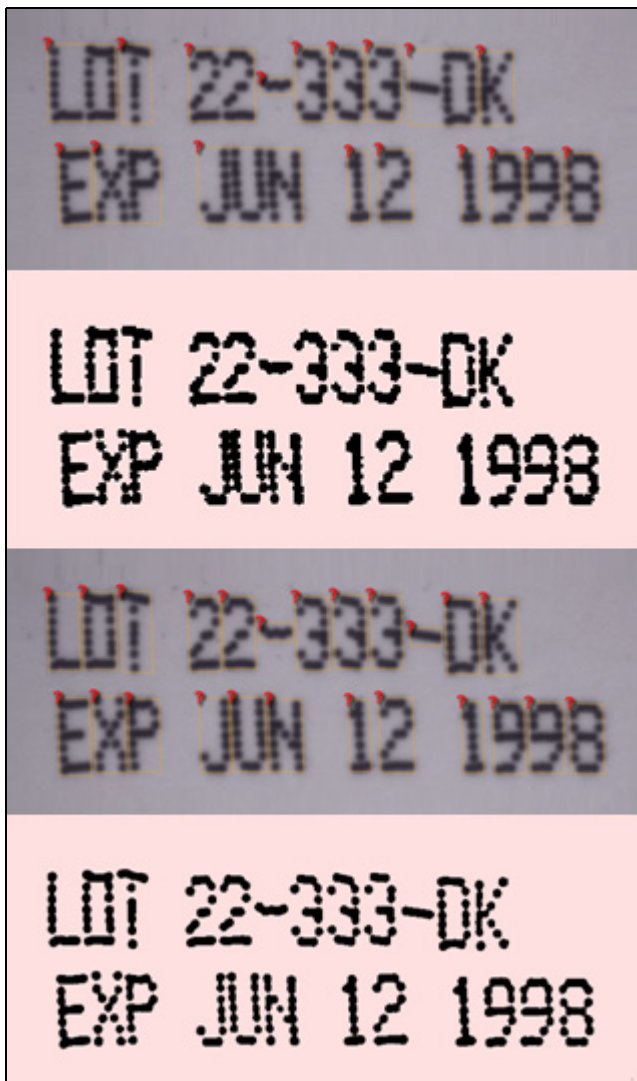

# Count Tool



The **Count Tool** allows you to count the number of objects found within the region of interest. This tool counts areas of connected light or dark pixels. The Count Tool is ideal for:

- Verifying the correct number of parts in a tray.
- Verifying the correct number of holes in a part.
- Detecting and reporting the number of objects in the image.

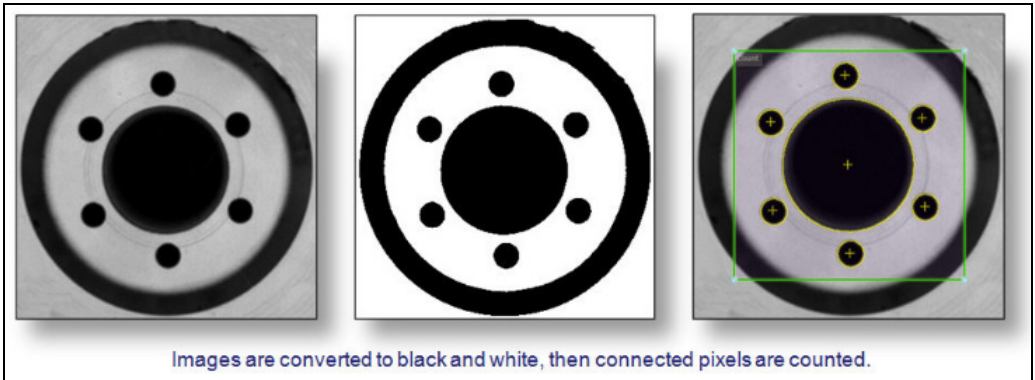

The Count Tool has a **Blob Count** capability and a **Shape Count** capability. Select Blob Count or Shape Count from the dropdown menu above the tool parameters.

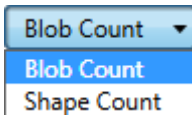

The Count Tool's Blob Count capability features **Image Pre-Processing**, which makes it easier for the tool to detect features in an image.

**Important:** When switching between **Blob Count** and **Shape Count**, the links between tool outputs and GDS tags are lost. This is because the underlying components that make up the Count Tool are completely removed and then recreated whenever you change the tool's capability.

## Count Tool Parameters

### Blob Count

- **Polarity:** Determines whether to count objects that are either lighter or darker than the background.

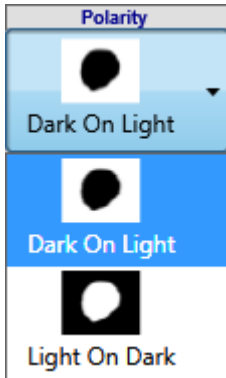

- **Ignore Blobs that Touch the ROI:** When enabled, blobs that touch the edge of the ROI will not be detected.

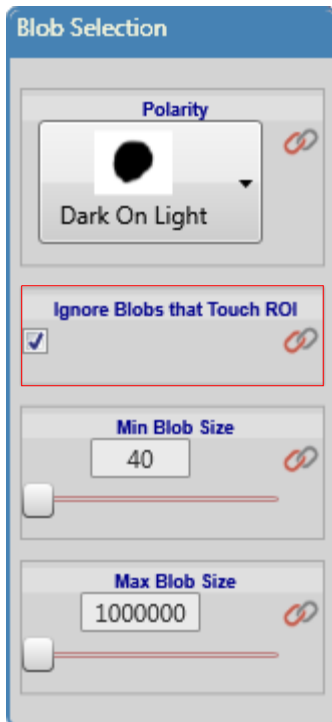



- **Min Blob Size:** Objects smaller than the defined size (in pixels) will be ignored.

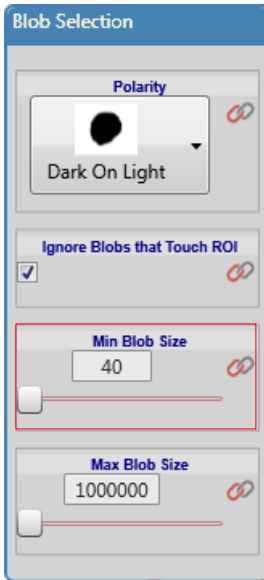

- **Max Blob Size:** Objects larger than the defined size (in pixels) will be ignored.

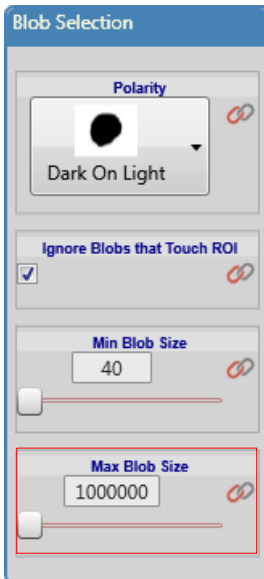

---

## Count Tool

- **Threshold:** The Count Tool's Blob Count capability displays a histogram of the gray values within its region of interest. This provides a visual aide when setting the tool's threshold value. The histogram shows where the majority of the dark pixels (to the left) and the light pixels (to the right) are on the gray scale. You can use the slider to adjust the threshold to a point between the two peaks. The portion of the histogram that is above the threshold is displayed in red; the portion that is below the threshold is displayed in blue.

Selecting **Auto Threshold** will instruct the software to compute the threshold automatically.

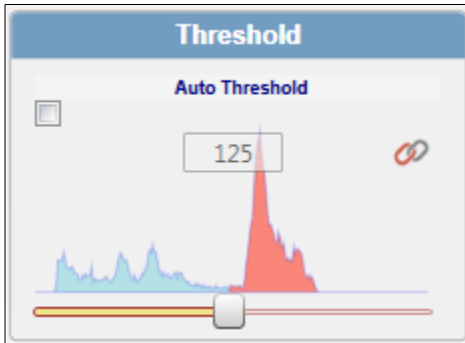

- **Tolerance:** Sets the tolerance on the minimum and maximum number of pixels allowable for the inspection to pass.

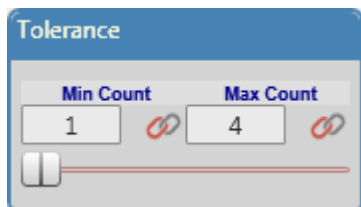

- **Enable ROI (Region of Interest) Rotation:** The Count Tool's Blob Count capability can be enabled for ROI rotation by clicking the rotation icon at the upper left of the parameters view.

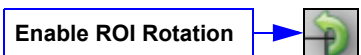

## Shape Count

- **Quick Find:** Uses a rough location. Faster but less accurate.
- **Fit Quality:** Defines how closely the identified feature must match the template (**Relaxed, Normal, Precise**).
- **Accept Threshold:** A ratio that determines how well the located feature must match the trained feature. (**0.1 – 1**, where **1** = perfect match.)

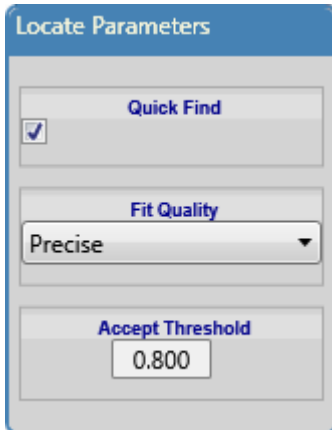

- **Allowed Rotation:** Sets a limit on how much the object can rotate and still be recognized.

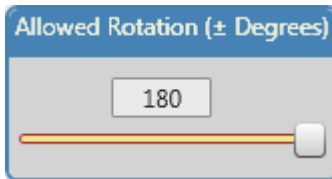

**Hint:** The Count Tool is configured to handle 360 degrees of rotation by default. However, reducing the Allowed Rotation (± Degrees) will speed up the tool's performance considerably.

- **Tolerance:** Sets the tolerance on the minimum and maximum number of pixels allowable for the inspection to pass.

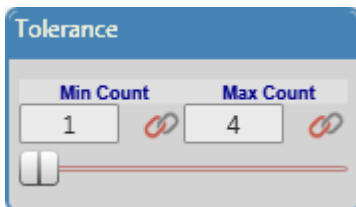

# Presence/Absence Tool



The **Presence/Absence Tool** detects the presence of a feature based on pixel intensity or contrast. This tool:

- Counts the number of pixels within a range of intensity from **0** to **255**.
- Counts the number of pixels where there is contrast in the image (pixels that lie along the edge of a feature, for example).

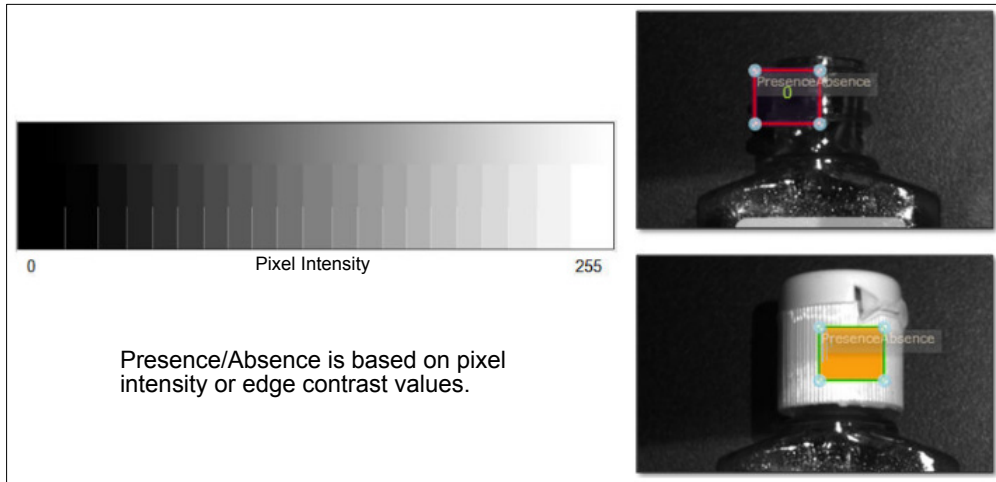

Presence/Absence is based on pixel intensity or edge contrast values.

## Presence/Absence Tool Parameters

- **Function:** Counts gray pixels within the range defined by the threshold; counts edge pixels that cross over the gradient threshold value.
- **Method:** Counts pixels between a range of gray values *or* counts pixels along an edge transition. **Count Edge Pixels** counts pixels along the edges of objects. **Count Gray Pixels** counts pixels that fall within the specified range of gray values.

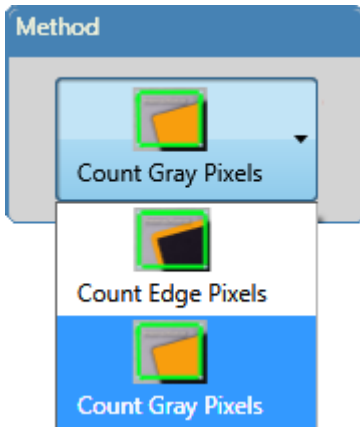

- **Threshold:** Sets the pixel value(s) to be located (**0** = black, **255** = white). This changes based on whether **Count Gray Pixels** or **Count Edge Pixels** is selected in the **Function** menu. Count Gray Pixels allows you to set both a **Low Threshold** and **High Threshold** within which to count. Count Edge Pixels allows you to determine the point at which a feature's edges are recognized as edges.

The Presence/Absence Tool's Count Gray Pixels capability displays a histogram of the gray values within its region of interest. This provides a visual aid when setting the tool's low and high threshold values. The dual slider allows you to adjust both the upper and lower thresholds. The portion of the histogram that is within the threshold range is displayed in yellow; the portion that is below the low threshold is displayed in blue; the portion that is above the high threshold is displayed in red.

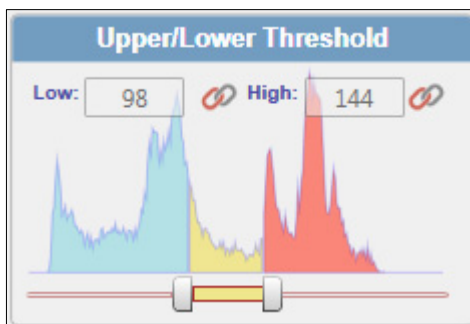

---

## Presence/Absence Tool

- **Tolerance:** Sets the tolerance on the minimum and maximum number of pixels allowable for the inspection to pass.

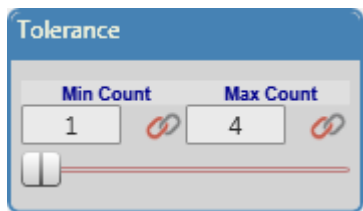

- **Enable ROI (Region of Interest) Rotation**

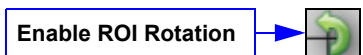

# Measure Tool



The **Measure Tool** allows you to perform width or height measurements between two edges. This tool:

- Finds two edges, then measures the distance between them.
- Looks for dark objects on a light background or light objects on a dark background.
- Outputs measurements in pixels.
- Rejects measurements outside the user-defined tolerances.
- Features **Image Pre-Processing**, which makes it easier for the tool to measure width, height, and angle within an image.

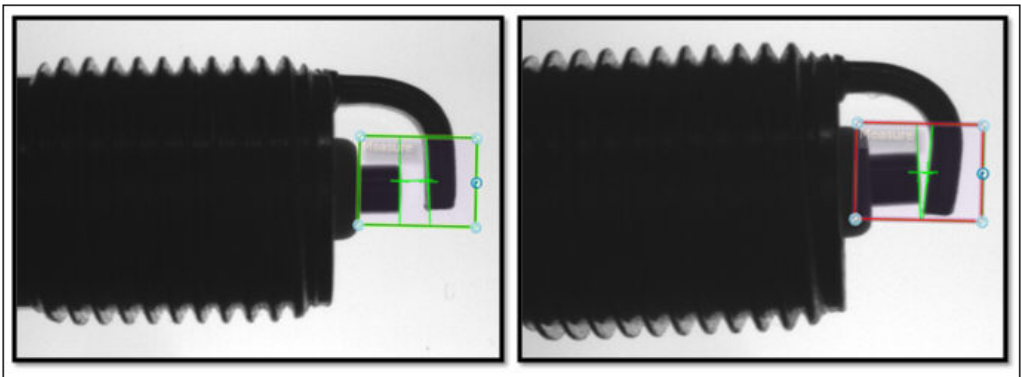

The Measure Tool has a **Width Measure**, **Height Measure**, **Circle Measure**, **Point to Point Measure**, **Point to Line Measure**, and **Angle Measure** capability. Select the desired capability from the dropdown menu above the tool parameters.

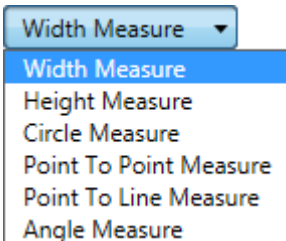

**Important:** When switching between measurement types, the links between tool outputs and GDS tags are lost. This is because the underlying components that make up the Measure Tool are completely removed and then recreated whenever you change the tool's capability.

## Measure Tool Parameters

### Width Measure

- **Function:** Width measurement
- **Edge Selection – Polarity:** Determines whether to measure a dark or light object with respect to the background. **Light to Dark Edges** searches for edges that transition from a light background to a dark object. **Dark to Light Edges** searches for edges that transition from a dark background to a light object. **Any Edge** searches for edges of any polarity.

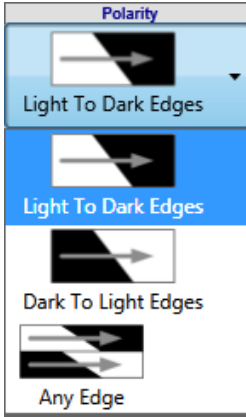

- **Edge Selection – Sharpness:** Determines the sharpness of the edge. **Very Sharp Edges (+/-1)** calculates gradients by looking 1 pixel before and 1 pixel after the analysis pixel. **Sharp Edges (+/-2)** calculates gradients by looking 2 pixels before and 2 pixels after the analysis pixel. **Blurry Edges (+/-3)** calculates gradients by looking 3 pixels before and 3 pixels after the analysis pixel. **Very Blurry Edges (+/-4)** calculates gradients by looking 4 pixels before and 4 pixels after the analysis pixel.

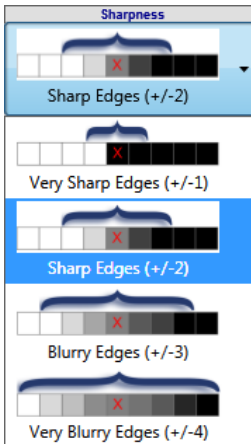



- **Edge Selection – Straightness:** Determines the straightness of the edge.

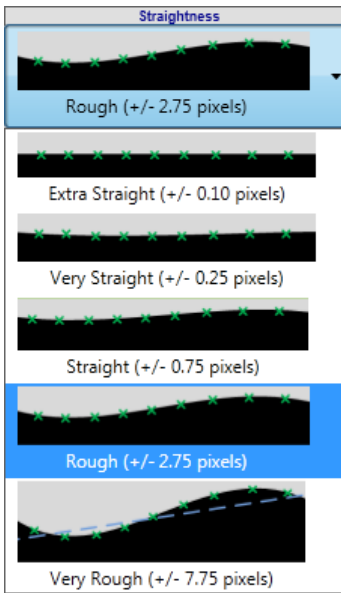

- **Distance Type:** Determines how the distance between two edges of the object should be calculated. **Point to Line Distance** measures the perpendicular distance from the first edge's center point to the second edge's best fit line. Choose Point to Line Distance when measuring between parallel lines. **Point to Point Distance** measures the distance from the center points of two edges. Choose Point to Point Distance when measuring between non-parallel lines, or when you want the rotation of the lines to be ignored.

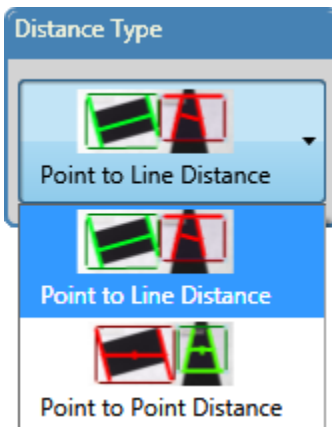

---

## Measure Tool

- **Edge Strength:** The Measure Tool provides a gradient plot to assist with the setting of the edge threshold. The plot shows you how strong the transitions from dark to light or light to dark (gradients) are within the tool's region of interest. The plot is calculated down the center of the ROI, left-to-right when measuring width, top-to-bottom when measuring height, and at the user-defined angle when measuring angle. A red horizontal line shows where the current threshold is set. Use the slider to adjust the threshold to an optimum value.

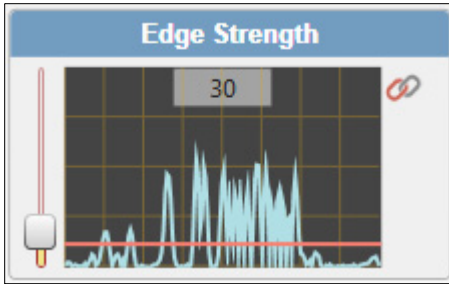

- **Tolerance:** Lower and upper tolerance in pixels.

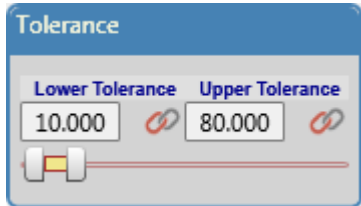

- **Enable ROI (Region of Interest) Rotation:** The Measure Tool's Width Measure capability can be enabled for ROI rotation by clicking the rotation icon at the upper left of the parameters view.

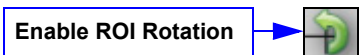

## Height Measure

- **Function:** Height measurement
- **Edge Selection – Polarity:** Determines whether to measure a dark or light object with respect to the background. **Light to Dark Edges** searches for edges that transition from a light background to a dark object. **Dark to Light Edges** searches for edges that transition from a dark background to a light object. **Any Edge** searches for edges of any polarity.

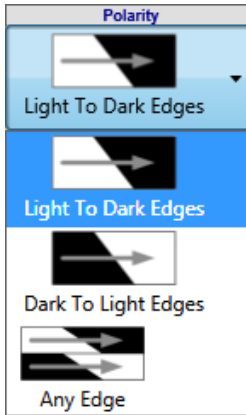

- **Edge Selection – Sharpness:** Determines the sharpness of the edge. **Very Sharp Edges (+/-1)** calculates gradients by looking 1 pixel before and 1 pixel after the analysis pixel. **Sharp Edges (+/-2)** calculates gradients by looking 2 pixels before and 2 pixels after the analysis pixel. **Blurry Edges (+/-3)** calculates gradients by looking 3 pixels before and 3 pixels after the analysis pixel. **Very Blurry Edges (+/-4)** calculates gradients by looking 4 pixels before and 4 pixels after the analysis pixel.

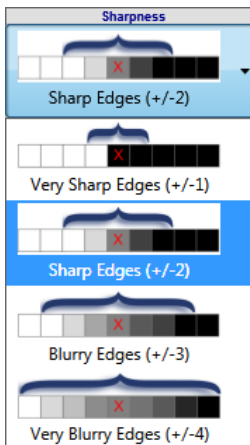

## Measure Tool

- **Edge Selection – Straightness:** Determines the straightness of the edge.

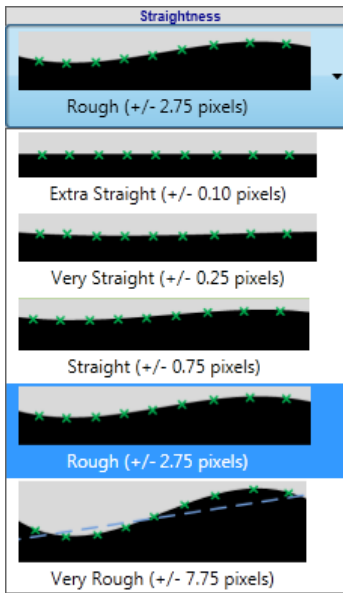

- **Distance Type:** Determines how the distance between two edges of the object should be calculated. **Point to Line Distance** measures the perpendicular distance from the first edge's center point to the second edge's best fit line. Choose Point to Line Distance when measuring between parallel lines. **Point to Point Distance** measures the distance from the center points of two edges. Choose Point to Point Distance when measuring between non-parallel lines, or when you want the rotation of the lines to be ignored.

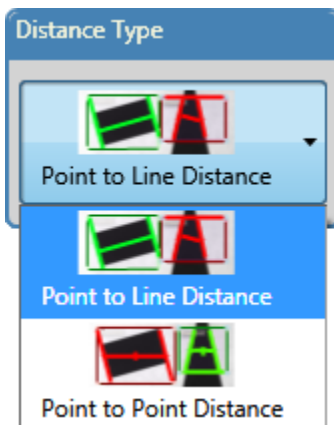

- **Edge Strength:** The Measure Tool provides a gradient plot to assist with the setting of the edge threshold. The plot shows you how strong the transitions from dark to light or light to dark (gradients) are within the tool's region of interest. The plot is calculated down the center of the ROI, left-to-right when measuring width, top-to-bottom when measuring height, and at the user-defined angle when measuring angle. A red horizontal line shows where the current threshold is set. Use the slider to adjust the threshold to an optimum value.

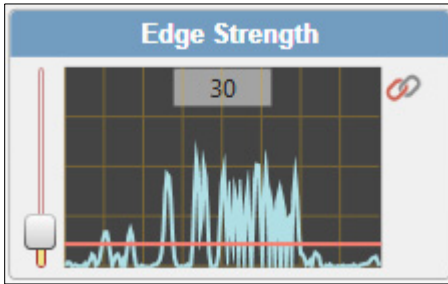

- **Tolerance:** Lower and upper tolerance in pixels.

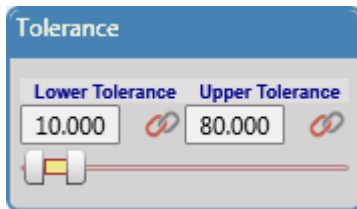

- **Enable ROI (Region of Interest) Rotation:** The Measure Tool's Height Measure capability can be enabled for ROI rotation by clicking the rotation icon at the upper left of the parameters view.

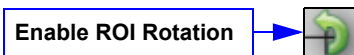

## Angle Measure

- **Function:** Angle measurement
- **Scan Direction:** Determines whether the tool will scan for an edge from top to bottom, left to right, right to left, or bottom to top.

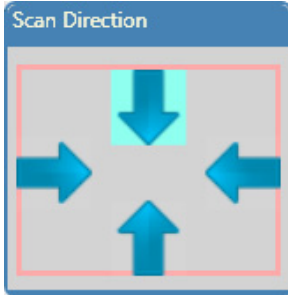

- **Edge Selection – Polarity:** Determines whether to measure a dark or light object with respect to the background. **Light to Dark Edges** searches for edges that transition from a light background to a dark object. **Dark to Light Edges** searches for edges that transition from a dark background to a light object. **Any Edge** searches for edges of any polarity.



- **Edge Selection – Sharpness:** Determines the sharpness of the edge. **Very Sharp Edges (+/-1)** calculates gradients by looking 1 pixel before and 1 pixel after the analysis pixel. **Sharp Edges (+/-2)** calculates gradients by looking 2 pixels before and 2 pixels after the analysis pixel. **Blurry Edges (+/-3)** calculates gradients by looking 3 pixels before and 3 pixels after the analysis pixel. **Very Blurry Edges (+/-4)** calculates gradients by looking 4 pixels before and 4 pixels after the analysis pixel.

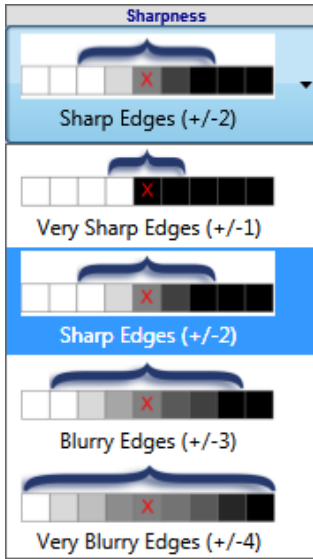

- **Edge Selection – Straightness:** Determines the straightness of the edge.

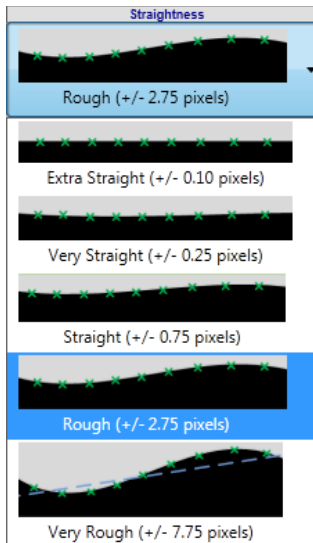

---

## Measure Tool

- **Edge Strength:** The Measure Tool provides a gradient plot to assist with the setting of the edge threshold. The plot shows you how strong the transitions from dark to light or light to dark (gradients) are within the tool's region of interest. The plot is calculated down the center of the ROI, left-to-right when measuring width, top-to-bottom when measuring height, and at the user-defined angle when measuring angle. A red horizontal line shows where the current threshold is set. Use the slider to adjust the threshold to an optimum value.

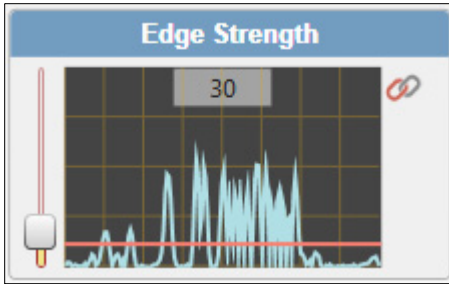

- **Tolerance:** Expected angle measurement and the range the angle can vary from the nominal angle, in degrees.

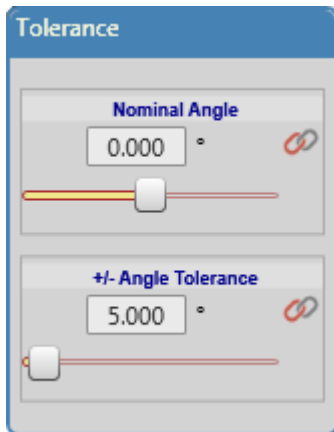

- **Enable ROI (Region of Interest) Rotation:** The Measure Tool's Angle Measure capability can be enabled for ROI rotation by clicking the rotation icon at the upper left of the parameters view.

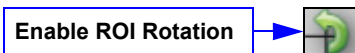



## Circle Measure

The Measure Tool in AutoVISION can also be used to measure the radius of a circle and to find its center point. Insert a Measure Tool into your job, and then use the dropdown at the top of the parameter area to select the Circle Measure option.

### Circle Shape

The circle shape that appears in the image area allows you to specify both an inner and an outer radius. This shape adjusts the start and end radius values without showing individual vectors. When first inserting a circle measurement, the inner radius will be **0** and the shape will look like this:



The size of the circle can be increased or decreased. The single anchor point in the center is for the inner radius. Grab the anchor point and drag down to open up the inner radius size as shown below:

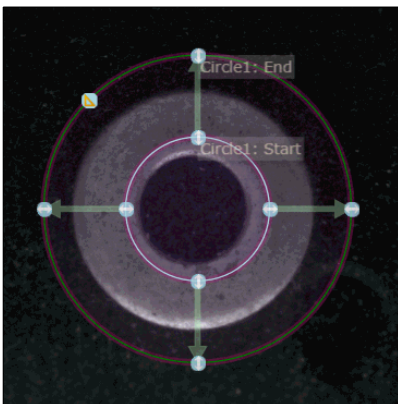

---

## Measure Tool

The inner circle is labeled as **Circle1:Start**, indicating that the edge scan will start here, and the outer circle is labeled **Circle1:End**, indicating that the edge scan will stop there. The green background arrows are also intended to show the direction in which the edge scan will proceed, which is inside to outside in this example. If you want to scan from the outside to in, simply increase the size of the Circle1:Start circle to make it larger than the Circle1:End circle, as shown here:

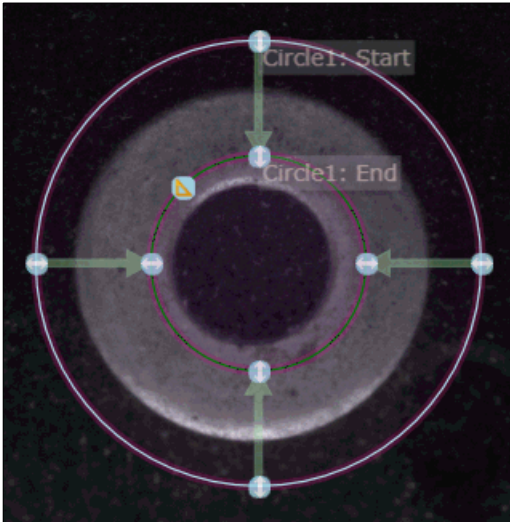

Note that the green arrows now point from the outside in.

## Parameters

The editors shown below are provided to configure the circle fit.

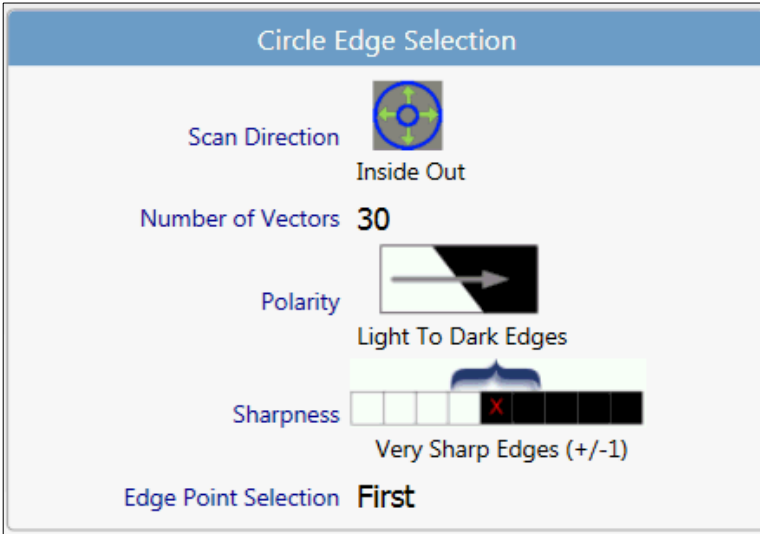

- **Scan Direction:** Sets the direction of the vector edge search, either from the inside out or from the outside in.
- **Number of Vectors:** This is the number of vectors that will be used to search for gradient points around the edge of the circle. These vectors will be equally spaced and arranged in a radial pattern.
- **Polarity:** Allows you to determine whether the vectors will search for light to dark edge transitions, dark to light, or both.
- **Sharpness:** Configures the number of pixels over which the gradient will be calculated. Select a lower value when you have very sharp edges, and select a larger value when your edges are more blurry.
- **Edge Point Selection:** When scanning the length of a given vector, you may find more than one edge point. This option tells the tool which edge point to select: the first, the best (largest gradient), or the last.

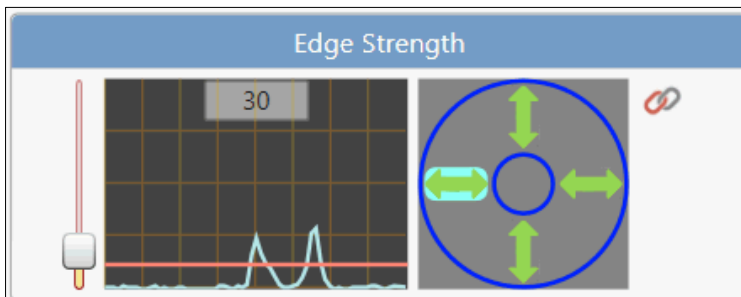

---

## Measure Tool

Similar to the Width and Height measurements, a gradient plot editor is provided for setting the minimum edge strength of the vectors. With a Width Measurement, the gradient plot is down the middle of the region of interest, moving from left to right. With a Height measurement, the gradient plot is also down the middle of the region of interest, but moving from top to bottom. With Circle measurement, it is selectable. Note that there is a control on the right that allows you select where the gradient scan is taken within the Circle measurement. If lighting around a given circle is uneven, this allows you to see the gradient values on the left, right, top, and bottom edges of the circle.

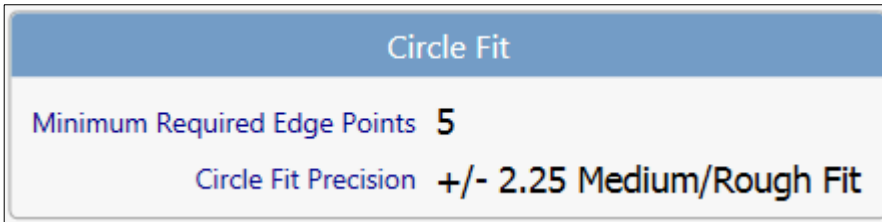

These are the options for the circle fit, which allows you to select the minimum number of vector edge points required for a valid circle fit, and then allows you to choose how precise that fit must be.

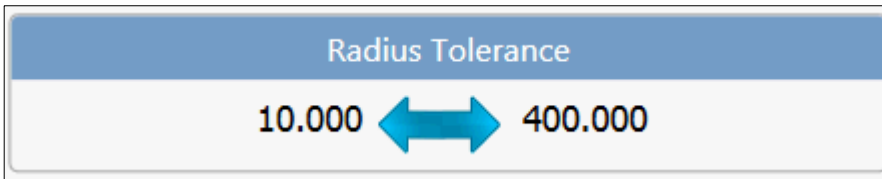

This is the tolerance on the radius of the circle.

### Setup Time Feedback

In Edit mode, if the Circle measurement is able to fit a circle, the tool will display the center and the radius of that circle.

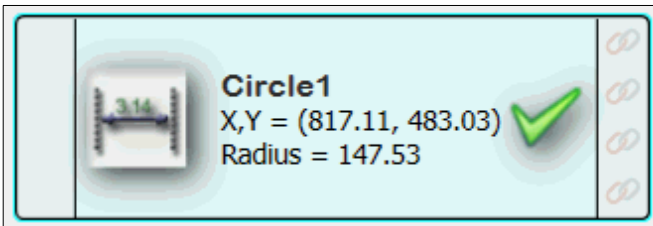

If unable to fit the circle, the tool will notify you and report the number of edge points found:

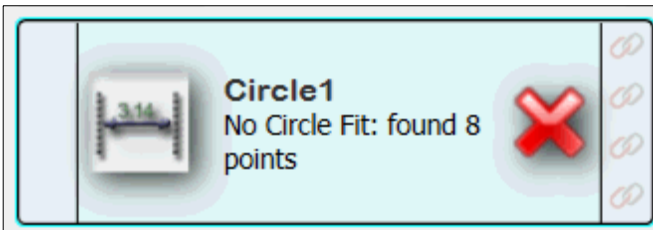

In the image, an 'X' will be drawn everywhere an edge point is found, and the fit circle will also be drawn:

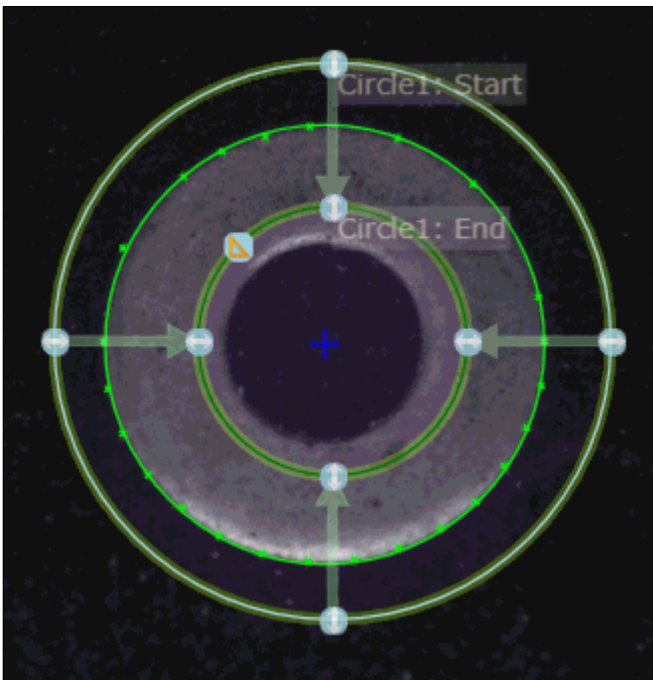

## Point to Point Measure

These parameters allow you to connect the two input points to output points from any other tool. The standard tolerance editor is also provided to allow the setting of an upper and lower measurement limit.

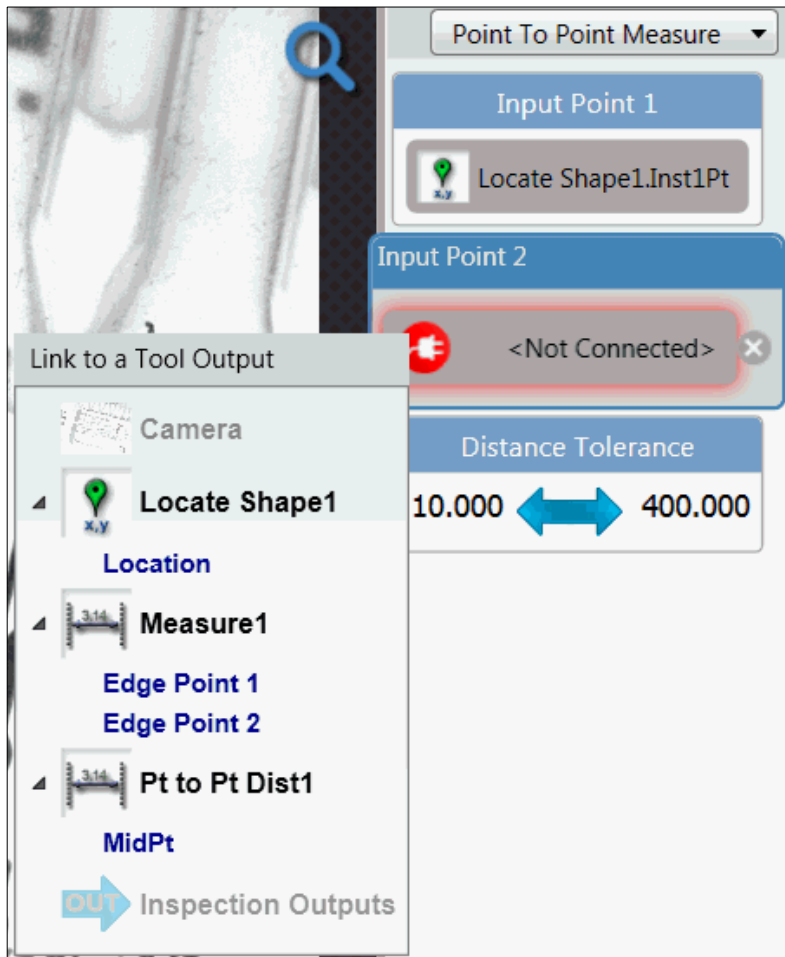

### Outputs

- **Distance:** The distance between the two input points.
- **Horizontal Distance:** Delta X between the two input points.
- **Vertical Distance:** Delta Y between the two input points.
- **Line:** The line that runs through the two input points (Advanced).
- **MidPt:** The point that is midway between the two input points (Advanced).

## Point to Line Measure

These parameters allow you to connect the input point and line to an output point and line from any other tool. The standard tolerance editor is also provided to allow the setting of an upper and lower measurement limit:

Point To Line Measure ▼

Input Point

<Not Connected>

Input Line

<Not Connected>

Distance Tolerance

10.000 ↔ 400.000

### Outputs

- **Distance:** The perpendicular distance between the input point and line.
- **Normal Point:** The point where the normal line intersects the input line (Advanced).
- **Normal Line:** Perpendicular line that runs from the input point through the input line (Advanced).

### Calibration

Both the Point to Point and Point to Line distance capabilities can be calibrated, as with other measurements. The Calibration editor will be present in the parameter area for both of these capabilities.

## Identifying an Edge

- Transitions between dark and light pixels are located.
- Several edge points are created from those transitions.
- The best possible line is then fit to the edge points.

The **Measure Tool** looks for transitions in grayscale and fits an edge to the transitions.

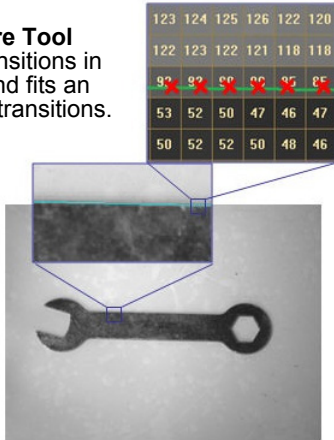

## Locating Transitions between Light and Dark

- Edge points are found based on gradient changes over a number of pixels.
- Threshold = Transition of gradient values
- Sharpness = Number of pixels allowed for gradient change

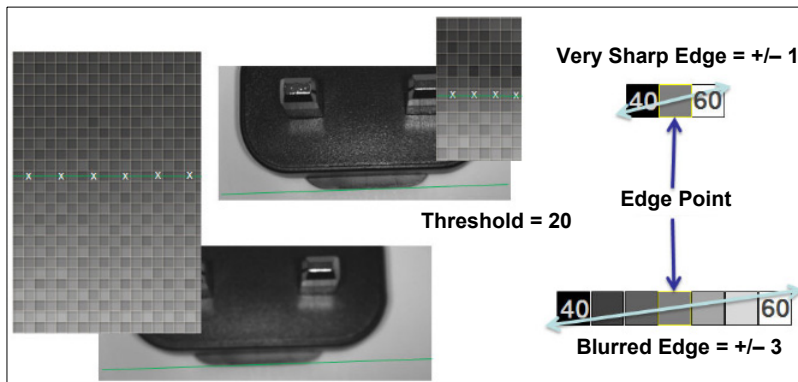



## ***Fitting an Edge Line to Edge Points***

- Edge straightness determines how to fit the line.

**Perfect Edge** = Accurate edge line placement; stray edge points are ignored.

**Rough Edge** = Edge line placement uses an average of all edge points including stray edges. This is useful when no clearly-defined line is available.

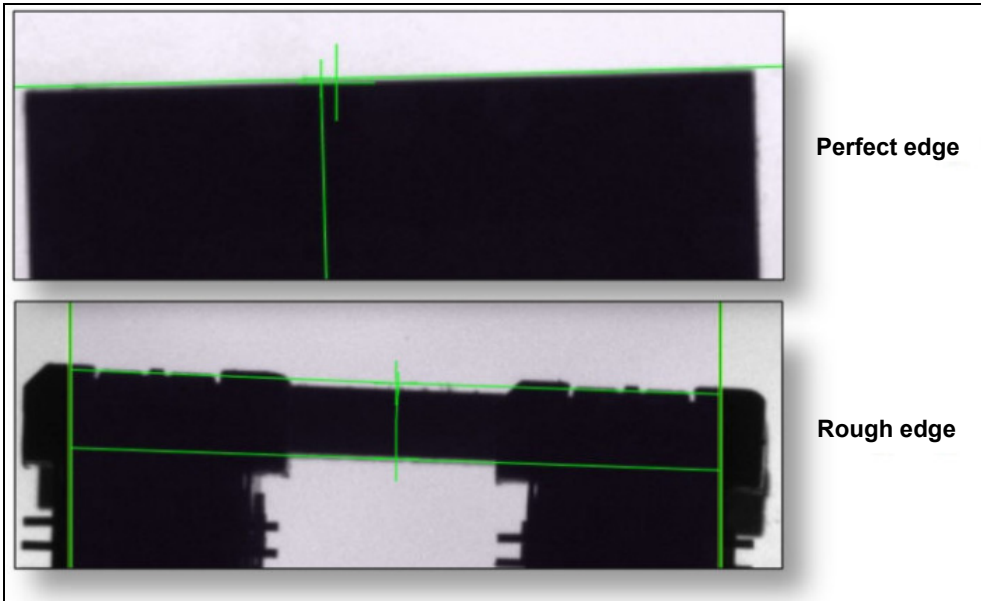

# Match Strings Tool



The **Match Strings Tool** allows you to specify the string that must be matched for the tool to pass.

The Match Strings Tool:

- Uses the outputs from the **Decode Tool**, **OCR Tool**, **String Format Tool**, and **Symbol Quality Verification Tool**.  
**Note:** These other tools must execute before Match Strings in the job list.
- Compares the two strings.
- Reports whether the tool passes (i.e. the two strings are the same) and when the tool fails (i.e. when the two strings are different).

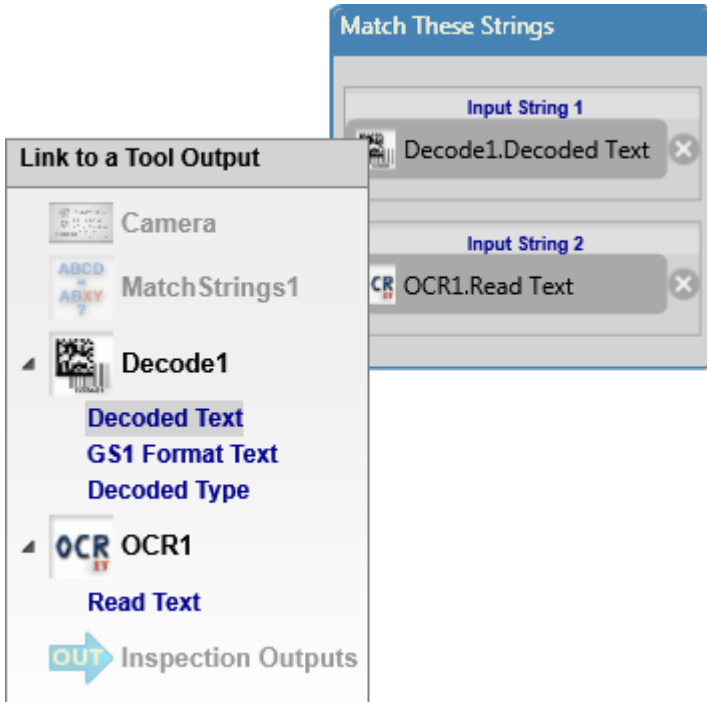

When the two strings match, the message "Strings Match" is shown in the main view area.

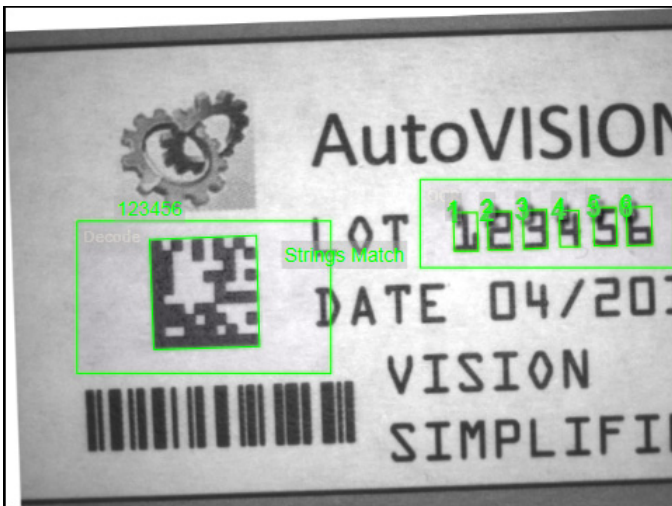

When the two strings don't match, the message "STRINGS DON'T MATCH!" is shown in the main view area.

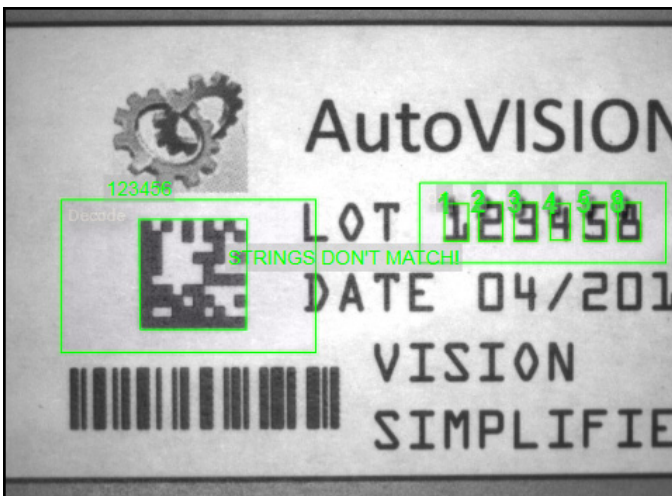

**Hint:** To reset the **Input String 1** or **Input String 2** values to **Not Connected**, click the **X** to the right of the value you want to disconnect.

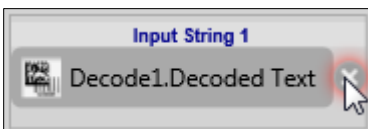

# String Format Tool



This tool allows you to format a string to be output. You can select up to two input strings and format based on the following rules:

- Extracted characters are specified by []. [1-4] extract characters 1 through 4. [12] Extracts character 12. [] = Entire string.
- Special characters are specified by '\'. \t (horizontal tab), \r (carriage return), and \n (new line) are supported.
- Any other characters are inserted into the final string.

### Examples:

- String = 123  
Format = Start[]end  
Output = Start123end
- String = ABCDEFG  
Format = [2-4][7]  
Output = BCDG
- String = ABCDEFG  
Format = \*[2-4]\*\*[7]?  
Output = \*BCD\*\*G?

**Note:** The String Format Tool only accepts the three special characters mentioned above.

### The String Format Tool can:

- Extract a substring from the input string(s) from the **Decode Tool**, **OCR Tool**, or **Symbol Quality Verification Tool**.
- Format characters to be appended or inserted into the input string;
- Append the second input string to the first input string (if two strings are specified).

**Hint:** Reformat the data as required, then use **Match Strings**.

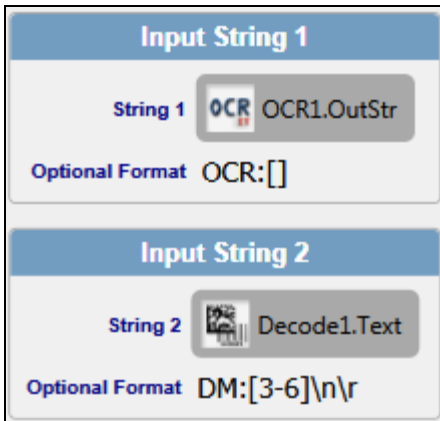

**Hint:** To reset the **Input String 1** or **Input String 2** values to **Not Connected**, right-click the Input String value you want to reset and click **Disconnect**.

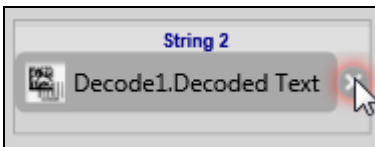

## Non-Printable Characters

The String Format Tool accepts the following special characters, which can be used to configure the output string:

**\a** bell

**\b** backspace

**\f** form feed

**\n** new line

**\r** carriage return

**\t** horizontal tab

**\v** vertical tab

**\'** single quote

**\x022** double quote ( " )

**\?** question mark

**\ooo** three digit octal notation ASCII value, i.e. **\145 = 'e'**

**\x0hh** hexadecimal notation ASCII value, i.e. **\0x04C = 'L'**

**Note:** To escape the **\** character, use the hexadecimal or octal versions **\x5c** or **\134**.

# Logic Tool



The **Logic Tool** allows you to build simple logic expressions in AutoVISION. These expressions make it possible to combine the results of multiple Tools and tie those results to outputs.

## Logic Tool Parameters

Click the **Logic Expression** field to start building a logic expression.



Click the **+** to show the **Logic Element Types** menu.

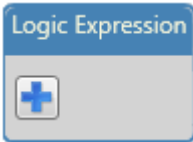

The Logic Element Types menu shows a list of logic elements that can be added to the expression: **Tool Output Value**, **Operator**, **Numeric Value**, and **Group**.

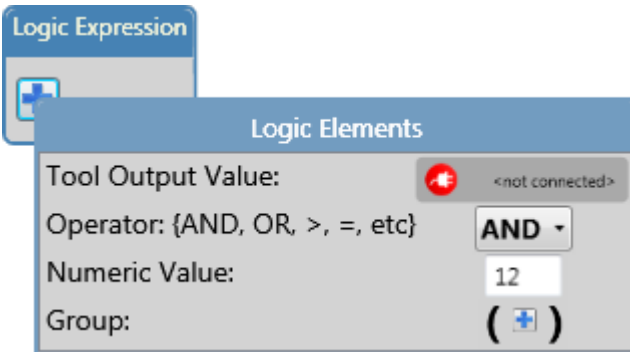

When you select a logic element, that element appears in the **Logic Expression** popup. You can now add further elements to build the logic expression.

## Value

In the example below, **Value** has been selected from the Logic Element Types menu, and the Status (pass/fail) of the Presence/Absence Tool from the vision job has been added to the logic expression.

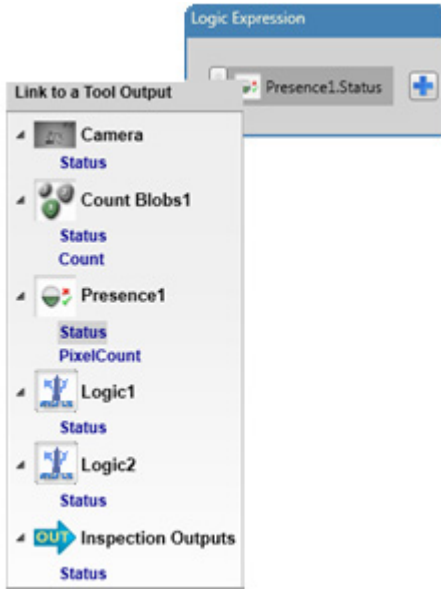

## Operator

Click the + button again to add another element to the logic expression. In the example below, **Operator** has been selected from the Logic Element Types menu. The operators **AND**, **OR**, **=**, **>**, **>=**, **<**, and **<=** can be added to the logic expression using the Operator dropdown menu.

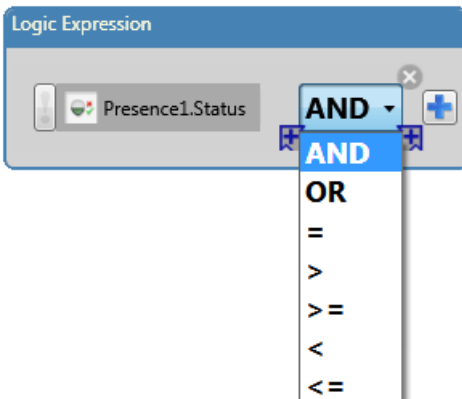

## Numeric Value

Select **Numeric Value** from the Logic Element Types menu to add text to the logic expression:

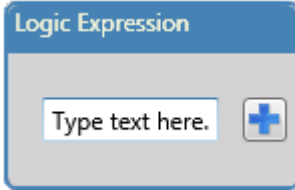

## Group

Parentheses can be added to the expression by selecting **Group** from the Logic Element Types menu. The Group element type has two + buttons for inserting elements inside and after the parentheses.



The example below shows an expression that has been built using the following sequence of Logic Element Types: **Value** (Presence/Absence Tool, Status output); **Operator**; **Group**; **Value** (Count Tool, Count output); **Operator**; and **Text**.

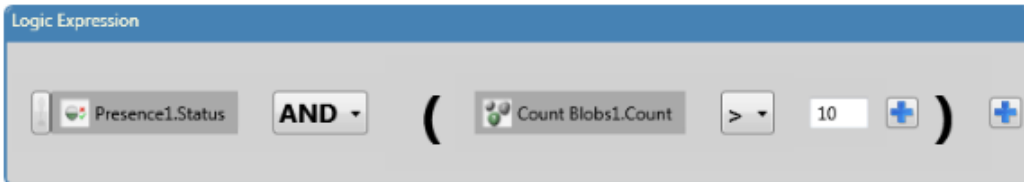

When the Logic Tool Editor is closed, the parameter panel for the Logic Tool shows the completed logic expression:

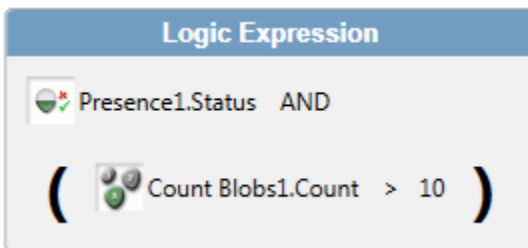



## NOT Button

The **NOT** button (!) appears to the left of any Tool Status Value that is added to the logic expression. When selected, it inverts the Status of the Tool Value. In the example below, the expression is TRUE if the Presence/Absence Tool fails.

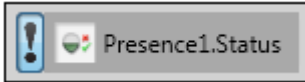



## Option Buttons

When you hover the mouse over any element in the logic expression, three option buttons appear at the corners of the element:



 = Remove this element from the expression.

 = Insert a new element BEFORE this one.

 = Insert a new element AFTER this one.

# OCV Tool



The **OCV Tool** verifies the quality of characters (also referred to as symbols) being inspected by comparing them to a standard font and detecting defects.

## OCV Tool Parameters

OCV Tool parameters include controls for **Defect Detection**, **Filtering**, and **Settings**.

The screenshot shows three sections of the OCV Tool parameter controls:

- Defect Detection:** Includes a green checkmark icon for 'Total Residue Area 15 %' and a greyed-out icon for 'Largest Res. Blob 10 %'.
- Filtering:** Includes 'Minimum Symbol Size 50' and 'Residue Cleanup 1'.
- Settings:** Includes 'Single Symbol' (greyed out) and 'AutoFind the Symbols' (checked).

## Defect Detection

Click the **Defect Detection** area of the OCV Tool parameters to display controls for **Tolerance** and **Units** (**Percentage** of total symbol size, or an absolute value in **Pixels**). You can also determine whether the tool bases defects on **Total Residue Area** or **Largest Blob**, or set it to **Check Minimum Contrast**, which rejects any symbol whose contrast falls below 50% of the trained symbol's contrast.

The detailed Defect Detection control panel includes:

- Residue Example:** Shows a 'Trained Symbol' (the number 6), an 'Inspected Symbol' (a distorted 6), and a 'Residue' image with red arrows pointing to the defects.
- Defects Based on...:** Radio buttons for 'Total Residue Area' (checked), 'Largest Blob', and 'Check Minimum Contrast'.
- Tolerance:** Input fields for '15.000' and '10'.
- Units:** A dropdown menu set to 'Percentage'.

## Filtering

Click the **Filtering** area of the OCV Tool parameters to display controls for **Minimum Symbol Size** and **Residue Cleanup**.

Minimum Symbol Size allows you to set the minimum number of pixels required for a blob to constitute a symbol.

Residue Cleanup allows you to set the number of pixels to remove around the perimeter of each blob of residue. Increase this value if the size of symbols varies by a large amount.

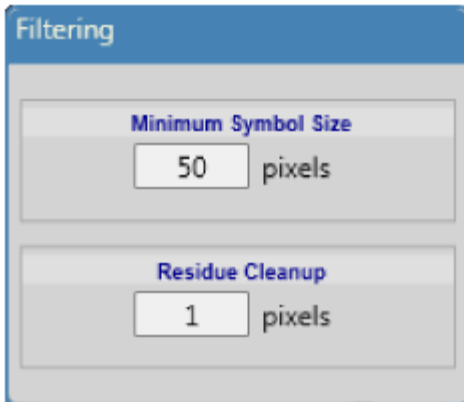

## Settings

Click the Settings area of the OCV Tool parameters to display controls for **Polarity**, **Single Symbol**, and **AutoFind the Symbols**.

The OCV Tool can usually detect polarity on its own, but when it can't, set Polarity directly to **Light on Dark** or **Dark on Light**.

Enable **Single Symbol** if you want all features within the template ROI (region of interest) to be trained as one symbol.

Enable **AutoFind the Symbols** to search automatically for trained symbols. Disable AutoFind to save processing time if you are already using a Locate Tool.

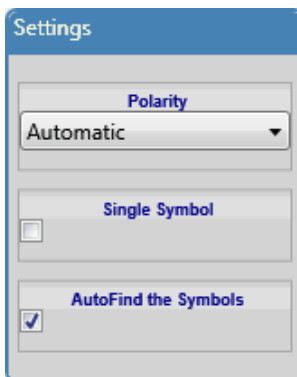

## Training the OCV Tool

The OCV Tool is trained in the same way as the **Locate Tool**.

- Add the **OCV Tool** to the image area.
- Adjust the **template ROI (region of interest)** around the feature that you want the tool to learn.
- Adjust the **boundary ROI** to cover the area within which you expect your feature to move from image to image.
- Train the tool to recognize the characters in the template ROI by clicking the **Train** icon.



Click the red icon to train the tool.

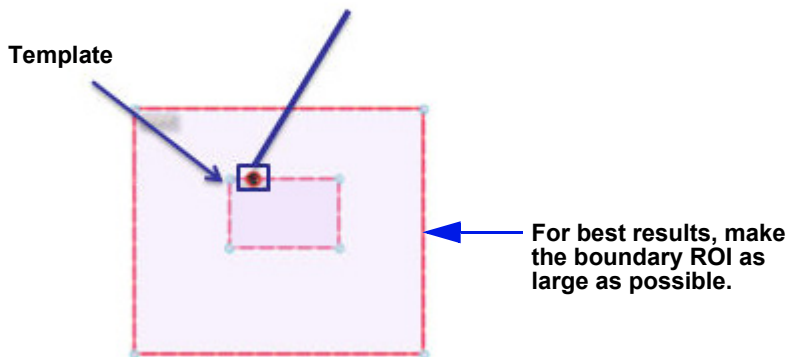

You can then verify the quality of individual characters in the inspection area.

**Hint:** Click on individual letters to show their detailed results as in the example below, which shows an analysis of a symbol's size and total residue area.

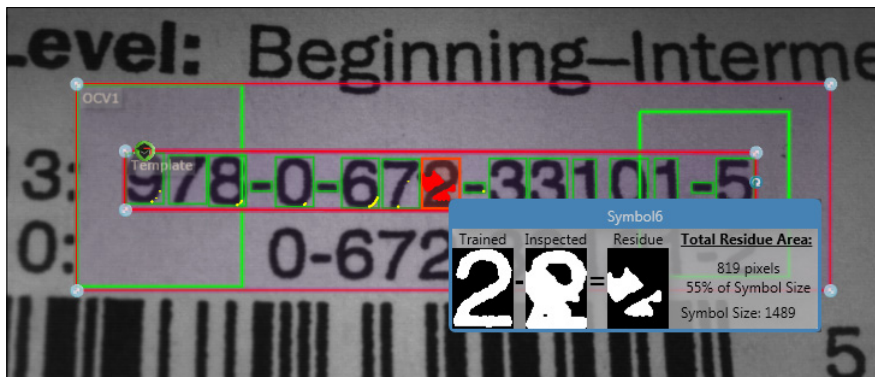

**Note:** When using the OCV Tool, you may see two additional boxes within the boundary ROI and outside the template ROI, as in the example above. This is normal and does not affect OCV Tool performance.

# Symbol Quality Verification Tool



The **Symbol Quality Verification Tool** evaluates 1D or 2D symbols against the **ISO 15415**, **AIM DPM/ISO 29158**, and **ISO 15416** standards, depending on which verification capability you select.

## Symbol Quality Verification Tool Parameters

ISO15415 ▼  
 ISO15415  
 AIM DPM/ISO 29158  
 ISO15416

**Important:** When switching between ISO 15415, AIM DPM/ISO 29158, and ISO 15416, the links between tool outputs and GDS tags are lost. This is because the underlying components that make up the Symbol Quality Verification Tool are completely removed and then recreated whenever you change the tool's capability.

## ISO 15415 Verification

### Verification Settings

Click the **Verification Settings** area of the parameters to bring up the controls for **Aperture**, **Lighting**, and **Setup Notes**.

**Verification Settings**

Aperture: Auto - 50%  
 Lighting: Wave Len = 640 / Ang = 90

**Calibration**

Uncalibrated

Rmin: 4      Rmax: 82  
 Symbol 1 Width: 0.24      Symbol 2 Width: 0.48  
 Maximum Exposure: 32000

**Custom Verification**

Enabled

-- Cell Contrast	A	B	C	D	F
-- Cell Modulation	A	B	C	D	F
-- Reflectance Margin	A	B	C	D	F
-- Fixed Pattern Damage	A	B	C	D	F
-- Axial Nonuniformity	A	B	C	D	F
-- Grid Nonuniformity	A	B	C	D	F
-- Unused Error Correction	A	B	C	D	F

**Aperture** automatically sets the aperture size to the user-defined percentage of the decoded cell size. Choose **Auto** if you want the aperture size to be set automatically based on the symbol's cell size. The aperture is set to 50% of the cell size by default. Turn Auto off if you want to enter the Aperture value manually. When Auto is de-selected, a dropdown menu appears allowing you to enter units in **mil** or **mm**.

Aperture:  Auto  5     
 mil  
 mm

**Lighting Wave Length** specifies the wavelength of the lighting being used. This value is for reporting only and does not affect verification results.

**Lighting Angle** specifies the angle of the lighting being used. Note that this value is for reporting only and does not affect verification results.

**Setup Notes** allows you to record any additional information that needs to be considered about your camera or lighting configuration.

### Calibration

Click the **Calibration** section of the parameters to bring up the dialog shown below. The Calibration dialog features simple instructions about how to calibrate your camera and the Verification Tool in order to be compliant with your chosen verification specification. You must have a Calibration card in order to calibrate your system.

Use this dialog to enter the data from your Calibration card, and then click the **Calibrate** button to start the process.

As part of the calibration process, the **Exposure Time** setting of your camera will be adjusted. Use the **Maximum Exposure** value in the Calibration dialog to set the maximum Exposure Time that can be set.

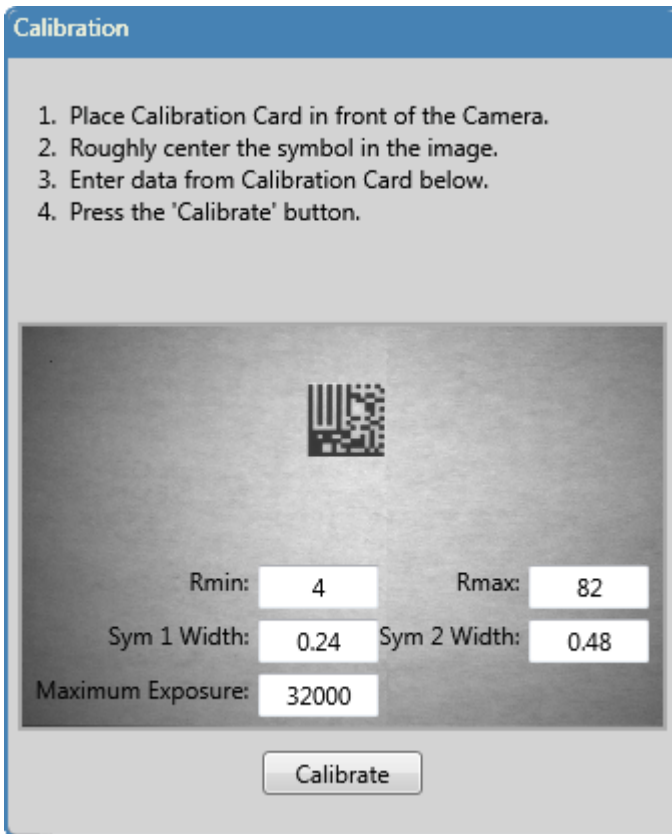

## Custom Verification

When you click the box next to **Enable Customized Verification Tests**, you will see the dialog shown below. This dialog allows you to select the individual attributes on which the verification will be based, and to define **Good/Fair/Poor** ranges for each attribute.

**Important:** Disabling parameters using the **Custom Verification** dialog results in a verification process that no longer strictly conforms to the ISO 15415 standard.

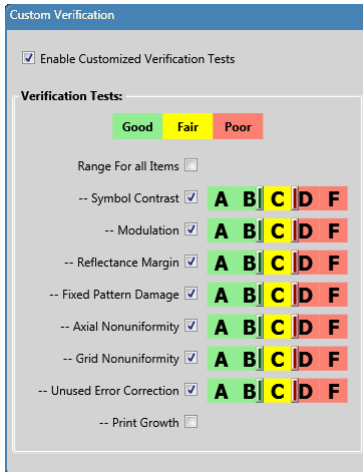

## ISO 15415 Verification Parameters

- **Symbol Contrast** — The difference in the population of dark pixels to the population of light pixels; compares to AIM DPM/ISO 29158 “Cell Contrast”.
- **Modulation** — In ISO/IEC 15415, a measurement of the uniformity of the color of the dark areas and the light areas of the Data Matrix similar to “Cell Modulation”, but differs in the implementation details.
- **Reflectance Margin** — A measurement of how well each module is correctly distinguishable as light or dark in comparison to the global threshold.
- **Fixed Pattern Damage** — A measurement of the errors in the borders of the Data Matrix as well as any errors in the quiet zone around the symbol necessary for the decoding process.
- **Axial Nonuniformity** — The difference between the height and the width with respect to the rows and columns.
- **Grid Nonuniformity** — This measurement is a delta of the difference of the measured grid in relation to the ideal grid formed from the four corners of the Data Matrix.
- **Unused Error Correction** — The amount of error correction that could be read incorrectly when the symbol is still readable that is currently being read correctly, expressed as a percentage.
- **Print Growth** — The positive or negative size relation of the cells as printed with respect to the ideal grid.
- **Reference Decode** — A pass/fail measurement of the Data Matrix based upon a binary image of the symbol as specified in ISO/IEC 16022.

**ISO 15415 Verification Report**

<b>A</b> <b>Good</b>	Reported Grade:	4.0/08/640/90
	>>	Grade: 4.0 / Aperture: 08 / WaveLength: 640 / LightAngle: 90
	Decode:	30Q324343430794<OQQ
	Cell Size:	15.5mil

Parameter Grades:		
	Grade	Score Units
Symbol Contrast	A	78 %
Modulation	A	
Reflectance Margin	A	
Fixed Pattern Dmg	A	
Axial NonUniformity	A	0 %
Grid NonUniformity	A	8 %
Unused Err Correction	A	100 %

Calibration Data:	
State:	Calibrated
Target Symbol 1 Width:	0.23
Target Symbol 2 Width:	0.47
Maximum Exposure:	32000
Target Rmin:	4
Target Rmax:	82

**ISO 15415 Numeric Score and Grade Level Comparison**

Grade	A 4	B 3	C 2	D 1	F 0	Comments
Axial Nonuniformity	<=0.06	<=0.08	<=0.10	<=0.12	>0.12	X and Y
Contrast	>=0.70	>=0.55	>=0.40	>=0.20	<0.20	
Fixed Pattern Damage	This measurement is developed through a three stage process. There is no grade correlation between raw score and the final score. The initial raw value is used with an overlay technique to achieve the final result.					
Grid Nonuniformity	<=0.38	<=0.50	<=0.63	<=0.75	>0.75	
Modulation	This measurement is developed through a three stage process. There is no grade correlation between raw score and the final score. The initial raw value is used with an overlay technique to achieve the final result.					
Reference Decode	Pass				Fail	
Unused Error Correction	>=0.62	>=0.50	>=0.37	>=0.25	<0.25	
Reflectance Margin	A measurement of how well each module is correctly distinguishable as light or dark in comparison to the global threshold.					



## ISO 15415 Verification Final Grade

The ISO 15415 final grade is shown in the upper left corner of the verification report and the numeric value is reported as the first field in the reported grade string. The final grade is defined by the lowest grade achieved by any individual grade parameter.

When custom verification is enabled, in addition to setting threshold for Good/Fair/Poor, you have the option to select which parameters are to be included in the final grade calculation. In the below example you can see the impact of removing Axial Non-Uniformity from the grade calculation.

**A**  
**Good**

Reported Grade: 4.0/5.8 pixels/640/90  
>> Grade: 4.0 / Aperture: 5.8 pixels / WaveLength: 640 / LightAngle: 90  
Decode: 01006141419999961750123110123ABC21ANU50  
Cell Size: 12.2 pixels

Parameter Grades:		
	Grade	Score Units
Symbol Contrast	A	81 %
Modulation	A	
Reflectance Margin	A	
Fixed Pattern Dmg	A	
Axial NonUniformity	D	11 %
Grid NonUniformity	A	3 %
Unused Err Correction	A	100 %

Calibration Data:	
State:	Calibrated
Target Symbol 1 Width:	0.24
Target Symbol 2 Width:	0.48
Maximum Exposure:	32000
Target Rmin:	4
Target Rmax:	82

## AIM DPM/ISO 29158 Verification

### Verification Settings

Click the **Verification Settings** area of the parameters to bring up the controls for **Aperture**, **Lighting**, and **Setup Notes**.

**Note: AIM DPM/ISO 29158** automatically determines and reports the aperture per the specification to either 50% or 80% of the nominal cell size of the symbol under test.

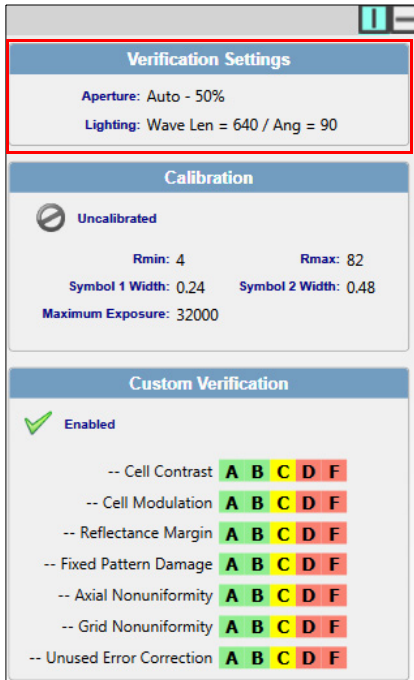

**Lighting Wave Length** specifies the wavelength of the lighting being used. This value is for reporting only and does not affect verification results.

**Lighting Angle** specifies the angle of the lighting being used. Note that this value is for reporting only and does not affect verification results.

**Setup Notes** allows you to record any additional information that needs to be considered about your camera or lighting configuration.

## Calibration

Click the **Calibration** section of the parameters to bring up the dialog shown below. The Calibration dialog features simple instructions about how to calibrate your camera and the Verification Tool in order to be compliant with your chosen verification specification. You must have a Calibration card in order to calibrate your system.

Use this dialog to enter the data from your Calibration card, and then click the **Calibrate Reflectance** button to start the process.

As part of the calibration process, the **Exposure Time** setting of your camera will be adjusted. Use the **Maximum Exposure** value in the Calibration dialog to set the maximum Exposure Time that can be set.

Calibration

**Reflectance Calibration**

1. Place Calibration Card in front of the Camera.
2. Roughly center the symbol in the image.
3. Enter data from Calibration Card below.
4. Press the 'Calibrate Reflectance' button.

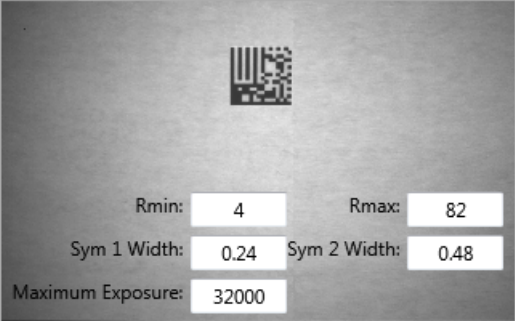

Rmin:	<input type="text" value="4"/>	Rmax:	<input type="text" value="82"/>
Sym 1 Width:	<input type="text" value="0.24"/>	Sym 2 Width:	<input type="text" value="0.48"/>
Maximum Exposure:	<input type="text" value="32000"/>		

**Part Calibration**

5. Place part in front of the Camera.
6. Click the 'Part Calibration' button.
7. Repeat steps 5 and 6 for each part.

**Important:** Part calibration must be performed per the AIM DPM standard to obtain proper results.

## Custom Verification

When you click the box next to **Enable Customized Verification Tests**, you will see the dialog shown below. This dialog allows you to select the individual attributes on which the verification will be based, and to define **Good/Fair/Poor** ranges for each attribute.

**Important:** Disabling parameters using the **Custom Verification** dialog results in a verification process that no longer strictly conforms to the AIM DPM/ISO 29158 standard.

### AIM DPM/ISO 29158 Verification Parameters

- **Cell Contrast** — In AIM DPM/ISO 29158, the difference in the population of dark pixels to the population of light pixels, using the sample principle as “Symbol Contrast” with modified definition.
- **Cell Modulation** — In AIM DPM/ISO 29158, a measurement of the uniformity of the color of the dark areas and the light areas of the Data Matrix similar to “Modulation”, but differing in the implementation details.
- **Reflectance Margin** — A measurement of how well each module is correctly distinguishable as light or dark in comparison to the global threshold.
- **Fixed Pattern Damage** — A measurement of the errors in the borders of the Data Matrix as well as any errors in the quiet zone around the symbol necessary for the decoding process.
- **Axial Nonuniformity** — The difference between the height and the width with respect to the rows and columns.
- **Grid Nonuniformity** — A delta of the difference of the measured grid in relation to the ideal grid formed from the four corners of the Data Matrix.
- **Unused Error Correction** — The amount of error correction that could be read incorrectly when the symbol is still readable that is currently being read correctly, expressed as a percentage.
- **Print Growth** — The positive or negative size relation of the cells as printed with respect to the ideal grid.
- **Minimum Reflectance** — During “Card Calibration”, the NIST-traceable card is used to calibrate the system and to calculate a “calibrated system reflectance value”. During “Part Calibration”, a good example of the actual part is used to calculate an exposure time that optimizes the brightness and contrast of that symbol. During the Verification cycle, the calibrated system reflectance value is compared with the reflectance value of the part viewed with this adjusted exposure time. Parts whose bright symbol elements are less reflective than the calibration standard card will need more light energy for the camera to achieve the appropriate image brightness. Minimum Reflectance is the ratio of the part’s reflectance to the calibrated system reflectance. Every part must provide at least a minimum level of reflectance.
- **Reference Decode** — A pass/fail measurement of the Data Matrix based upon a binary image of the symbol as specified in ISO/IEC 16022.

## AIM DPM/ISO 29158 Verification Report

**A**  
**Good**

Reported Grade: DPM4.0/19/640/90  
 >> Grade: DPM4.0 / Aperture: 19 / WaveLength: 640 / LightAngle: 90  
 Decode: 0100614141999961750123110123ABC21MASTER50  
 Cell Size: 24.9 mil

	Grade	Score	Units
Cell Contrast	A	73	%
Cell Modulation	A		
Reflectance Margin	A		
Minimum Reflectance	A	76	
Fixed Pattern Dmg	A		
Axial NonUniformity	A	1	%
Grid NonUniformity	A	6	%
Unused Err Correction	A	100	%

State:	Calibrated
Target Symbol 1 Width:	0.24
Target Symbol 2 Width:	0.48
Maximum Exposure:	32000
Target Rmin:	4
Target Rmax:	82

Options... Save...

## AIM DPM/ISO 29158 Numeric Score and Grade Level Comparison

Grade	A 4	B 3	C 2	D 1	F 0	Comments
Cell Contrast	>=30%	>=25%	>=20%	>=15%	<15%	
Axial Nonuniformity	<=6%	<=8%	<=10%	<=12%	>12%	Calculation differs slightly from ISO 15415
Grid Nonuniformity	<=0.38	<=0.50	<=0.63	<=0.75	>0.75	Calculation differs slightly from ISO 15415
Unused Error Correction	>=62%	>=50%	>=37%	>=25%	<25%	
Fixed Pattern Damage	This measurement is developed through a three stage process. There is no grade correlation between raw score and the final score. The initial raw value is used with an overlay technique to achieve the final result.					
Cell Modulation	This measurement is developed through a three stage process. There is no grade correlation between raw score and the final score. The initial raw value is used with an overlay technique to achieve the final result.					
Reference Decode	Pass				Fail	
Minimum Reflectance	>=5%				<5%	
Reflectance Margin	A measurement of how well each module is correctly distinguishable as light or dark in comparison to the global threshold.					

## AIM DPM/ISO 29158 Verification Final Grade

The AIM DPM/ISO 29158 final grade is determined in the same way as the ISO 15415 final grade.

## ISO 15416 Verification

### Symbology Types

Click the **Symbology Types** you want to verify to the ISO 15416 standard.

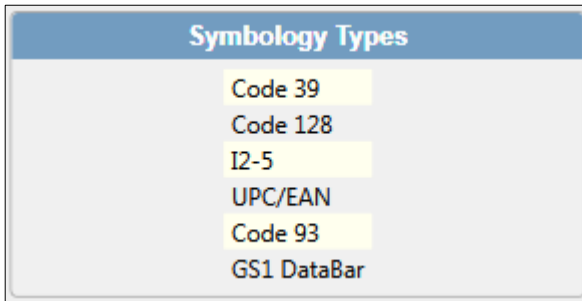

### Verification Settings

Click the **Verification Settings** area of the parameters to bring up the controls for **Aperture**, **Signal Compensation**, **Lighting**, and **Setup Notes**.

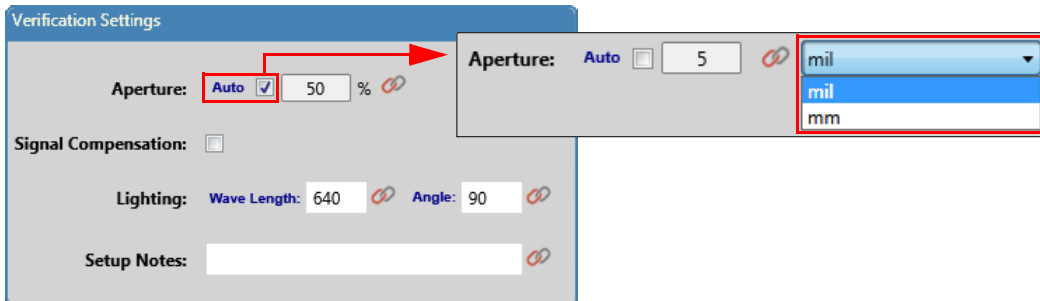

**Aperture** automatically sets the aperture size to the user-defined percentage of the decoded cell size.

**Signal Compensation** compensates for uneven lighting. This parameter improves grading performance, but note that it is not a part of the ISO 15416 standard, and therefore not technically compliant.

**Lighting Wave Length** specifies the wavelength of the lighting being used. Note that this value is for reporting only and does not affect verification results.

**Lighting Angle** specifies the angle of the lighting being used. Note that this value is for reporting only and does not affect verification results.

**Setup Notes** allows you to add any other information about your camera or lighting configuration that needs to be considered.

## Calibration

Click the **Calibration** section of the parameters to bring up the dialog shown below. The Calibration dialog features simple instructions about how to calibrate your camera and the Verification Tool in order to be compliant with your chosen verification specification. You must have a Calibration card in order to calibrate your system.

Use this dialog to enter the data from your Calibration card, and then click the **Calibrate** button to start the process.

As part of the calibration process, the **Exposure Time** setting of your camera will be adjusted. Use the **Maximum Exposure** value in the Calibration dialog to set the maximum Exposure Time that can be set.

**Calibration**

1. Place Calibration Card in front of the Camera.
2. Roughly center the symbol in the image.
3. Enter data from Calibration Card below.
4. Press the 'Calibrate' button.

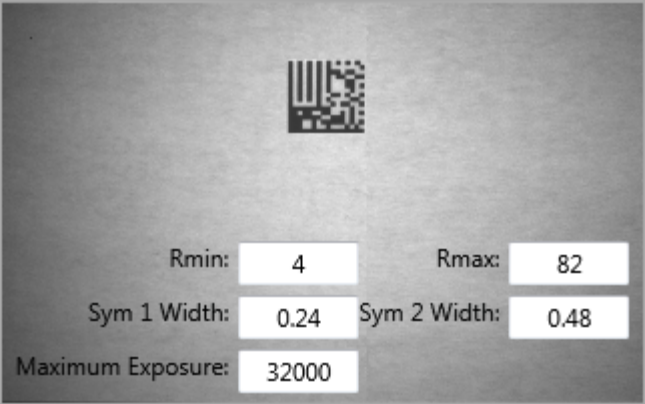

Rmin:  Rmax:

Sym 1 Width:  Sym 2 Width:

Maximum Exposure:

### Custom Verification

When you click the box next to **Enable Customized Verification Tests**, you will see the dialog shown below. This dialog allows you to select the individual attributes on which the verification will be based, and to define **Good/Fair/Poor** ranges for each attribute.

**Important:** Disabling parameters using the **Custom Verification** dialog results in a verification process that no longer strictly conforms to the ISO 15416 standard.

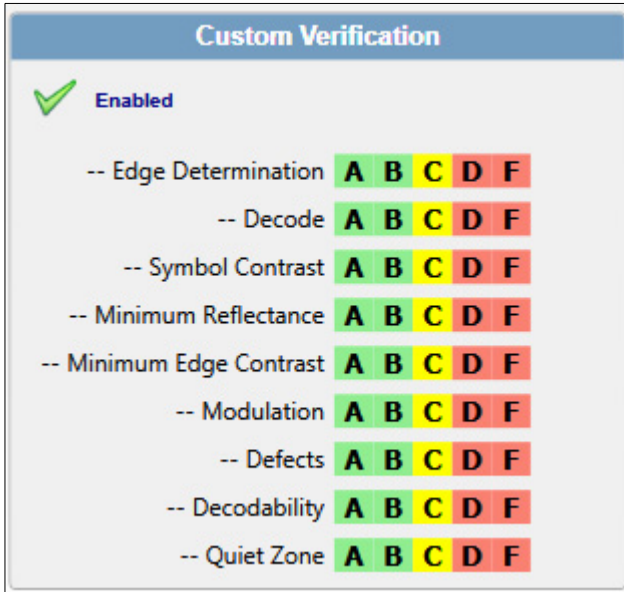

### Custom Verification Editor

The **Custom Verification Editor** is used to define when grades are considered **Good** or **Fair**. ISO 15416 reports a floating point grade value and allows you to define limits for Good or Fair based on letter grades. If you want to specify numeric values for Good and Fair limits, check the **Use Numeric Values (for floating point control)** option. The standard **ABCDF** control is replaced with a different control that allows you to enter any numeric value for Good and Fair limits. The example below shows the default numerical Good and Fair values of **2.5** and **1.5** respectively.

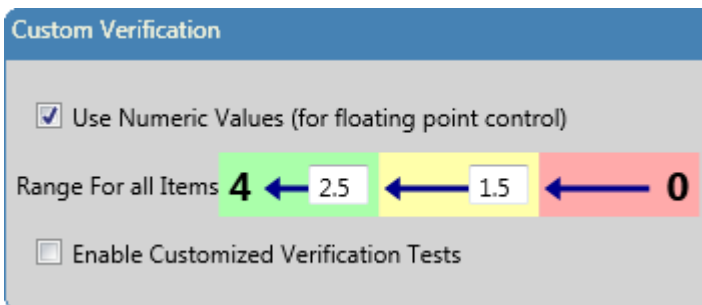



## **ISO 15416 Verification Parameters**

- **Edge Determination** — Bar and space edge transitions are defined by where they cross the global threshold of the symbol. The global threshold is the midpoint of the maximum reflectance (brightest) and the minimum reflectance (darkest) sample in the scan line. If the global threshold is crossed more than once per bar space transition or does not cross between one of these bar space pairs the symbol will not be able to decode and will receive an **F** grade for Edge Determination. If the proper number of element transitions occurs the symbol will receive an **A** grade for Edge Determination.
- **Decode** — The decoding of the symbol using the symbology reference decode algorithm using the element edges found in Edge Determination.
- **Symbol Contrast** — The difference between the highest and the lowest reflectance values in a scan reflectance profile.
- **Minimum Reflectance** — Percentage value of reflectance of darkest bar.
- **Minimum Edge Contrast** — Percentage value of minimum edge contrast. Edge Contrast is the difference between the bar reflectance and space reflectance of two adjacent elements.
- **Modulation** — The ratio of minimum edge contrast to symbol contrast.
- **Defects** — Irregularities found within elements and quiet zones, measured in terms of element reflectance non-uniformity.
- **Decodability** — Decodability can be defined as the amount of margin remaining to properly read the characters in the symbol. Each symbology specification graded under ISO 15416 has published dimensions and margins of tolerance for the decoding of characters. Printing and imaging accuracy will impact these dimensions and the ability to decode the symbol. Decodability quantifies this margin for each symbol.
- **Quiet Zone** — The regions before the start and stop characters. Each symbology specification graded under ISO 15416 has published the required amount of Quiet Zone for both the region before the start and after the stop character. The Quiet Zone is measured as an integer factor of the nominal bar width. For example, 10x would be a quiet zone 10 times larger than the nominal bar width. If either the start or stop Quiet Zone is violated, the scan line will receive an **F** grade for the Quiet Zone for that scan line.

# ISO 15416 Verification Report

ISO15416 Verification1 : Verification Report
\_ □ ×

B

Reported Grade: 2.9/09/640/90

>> Grade: 2.9 / Aperture: 09 / WaveLength: 640 / LightAngle: 90

Decode: 0000006300005

Bar Width: 9.5mil

Good

**Parameter Grades:**

	1	2	3	4	5	6	7	8	9	10	Avg
Edge Determination	A	A	A	A	A	A	A	A	A	A	A
Decode	A	A	A	A	A	A	A	A	A	A	A
Symbol Contrast	A	A	A	A	A	A	A	A	A	A	A
	80%	80%	80%	79%	80%	79%	79%	79%	79%	78%	
Min Reflectance	A	A	A	A	A	A	A	A	A	A	A
	(11-91)%	(11-91)%	(11-91)%	(11-90)%	(11-91)%	(11-90)%	(11-90)%	(11-90)%	(11-90)%	(11-89)%	
Min Edge Contrast	A	A	A	A	A	A	A	A	A	A	A
	62%	62%	62%	62%	62%	61%	62%	61%	62%	62%	
Modulation	A	A	A	A	A	A	A	A	A	A	A
	78%	77%	78%	78%	77%	77%	78%	77%	78%	79%	
Defects	B	C	B	B	B	B	B	B	B	B	B
	20	21	20	20	20	18	17	18	18	18	
Decodability	A	A	A	A	A	A	A	A	A	A	A
	92%	93%	91%	92%	91%	92%	93%	92%	93%	92%	
QuietZone	A	A	A	A	A	A	A	A	A	A	A
	(8.9-8.9)	(8.9-8.9)	(8.9-8.9)	(8.9-8.9)	(8.9-8.9)	(8.9-8.9)	(8.9-8.9)	(8.9-8.9)	(8.9-8.9)	(8.9-8.9)	
Final	B	C	B	B	B	B	B	B	B	B	B
	3	2	3	3	3	3	3	3	3	3	

**Calibration Data:**

State:	Calibrated
Target Symbol 1 Width:	0.23
Target Symbol 2 Width:	0.47
Target Rmin:	4
Target Rmax:	82
Max Exposure:	32000

## ISO 15416 Numeric Score and Grade Level Comparison

Grade	A 4	B 3	C 2	D 1	F 0	Comments
Min Reflectance	<=0.5Rmax				>0.5Rmax	Rmax is Max Reflectance
Symbol Contrast	>=0.70	>=0.55	>=0.40	>=0.20	<0.20	
Min Edge Contrast	>=0.15				<0.15	
Modulation	>=0.70	>=0.60	>=0.50	>=0.40	<0.40	
Defects	<=0.15	<=0.20	<=0.25	<=0.30	>0.30	
Decodability	>=0.62	>=0.50	>=0.37	>=0.25	<0.25	
Quiet Zone	>= spec				< spec	

## ISO 15416 Verification Final Grade

The ISO 15416 final symbol grade is shown in the upper left corner and lower right corner of the verification report and the numeric grade is reported as the first field in the reported grade string. The ISO 15416 final symbol grade is a compilation of the 10 individual scan line final grades applied over the region of the symbol. Each individual scan grade from the 10 scans applied can be found at the bottom of each scan column. This scan grade is the lowest grade from that individual scan. The final symbol grade is the average result of the 10 individual scans. In the follow example you see scans 1-5 have quiet zone violations and receive a grade of F or grade value 0. The scans 6-10 receive a B grade based on the minimum grade of modulation. The final symbol grade is the average of the final scans  $(0 + 0 + 0 + 0 + 0 + 3 + 3 + 3 + 3 + 3) / 10 = 1.5$  or grade C. Note that if custom verification is enabled individual parameters can be removed from the scan grade and final grade calculation.

**ISO15416 Verification1: Verification Report**

**C**  
**Fair**

Reported Grade: 1.5/3.0 pixels/640/90  
>> Grade: 1.5 / Aperture: 3.0 pixels / WaveLength: 640 / LightAngle: 90  
Decode: 00006141411234567890  
Bar Width: 5.9 pixels

Parameter Grades:	1	2	3	4	5	6	7	8	9	10	Avg
Edge Determination	A	A	A	A	A	A	A	A	A	A	A
Decode	A	A	A	A	A	A	A	A	A	A	A
Symbol Contrast	A	A	A	A	A	A	A	A	A	A	A
	76%	77%	77%	78%	78%	79%	80%	81%	81%	82%	
Min Reflectance	A	A	A	A	A	A	A	A	A	A	A
	(9-85)%	(9-86)%	(9-86)%	(9-87)%	(9-87)%	(8-87)%	(8-88)%	(8-89)%	(9-90)%	(9-91)%	
Min Edge Contrast	A	A	A	A	A	A	A	A	A	A	A
	55%	56%	56%	55%	55%	55%	55%	55%	55%	54%	
Modulation	A	A	A	A	A	B	B	B	B	B	A
	72%	72%	72%	71%	70%	69%	69%	67%	67%	66%	
Defects	A	A	A	A	A	A	A	A	A	A	A
	3	3	3	2	3	5	5	4	5	6	
Decodability	A	A	A	A	A	A	A	A	A	A	A
	84%	88%	87%	88%	84%	86%	86%	87%	87%	87%	
QuietZone	F	F	F	F	F	A	A	A	A	A	C
	(6.6-6.8)	(6.6-6.8)	(6.8-6.8)	(6.6-6.8)	(6.6-6.8)	(10-10)	(10-10)	(10-10)	(10-10)	(10-10)	
Final	F	F	F	F	F	B	B	B	B	B	C
	0	0	0	0	0	3	3	3	3	3	

**Calibration Data:**

State: Not Calibrated

Target Symbol 1 Width: 0

Target Symbol 2 Width: 0

Target Rmin: 4

Target Rmax: 82

Max Exposure: 32000

## Verification Results

All verification output values can be output through **Inspection Outputs**. All verification status outputs can be tied to the camera's **Digital Outputs**.

**Digital Outputs**

Output 1    Output 2    Output 3

<Not Connected>    <Not Connected>    <Not Connected>

Connect Output to a Tool Status

- Camera
  - Picture Done
  - Expose Done
  - Trigger Overrun
  - Process Overrun
- ISO15415 Verification1
  - ISO15415 Verification1 Passed
  - ISO15415 Verification1 Failed
  - ISO15415 Verification1 - Dimension Status
  - ISO15415 Verification1 - Good Status
  - ISO15415 Verification1 - Fair Status
  - ISO15415 Verification1 - Poor Status
- OUT Inspection Outputs
  - Inspection Passed
  - Inspection Failed
  - Inspection Done

## Symbol Quality Verification Reports

The report that is produced by AIM DPM/ISO 29158, ISO 15415, and ISO 15416 Symbol Quality Verification can be saved in either PDF or plain text format.

ISO15416 Verification1 : Verification Report

**D**  
**(0.8)**  
**Poor**

Reported Grade: 0.8/5.3 pixels/640/90  
>> Grade: 0.8 / Aperture: 5.3 pixels / Wavelength: 640 / LightAngle: 90  
Decode: 10037000849107  
Bar Width: 10.7 pixels

Parameter Grades:

	1	2	3	4	5	6	7	8	9	10
Edge Determination	A(4)	A(4)	A(4)	A(4)	A(4)	A(4)	A(4)	A(4)	A(4)	A(4)
Decode	A(4)	A(4)	A(4)	A(4)	A(4)	A(4)	A(4)	A(4)	A(4)	A(4)
Symbol Contrast	D(1)	D(1)	D(1)	D(1)	D(1)	D(1)	D(1)	C(2)	D(1)	D(1)
	37%	36%	35%	36%	36%	36%	34%	41%	32%	35%
Min Reflectance	A(4)	A(4)	A(4)	A(4)	A(4)	A(4)	A(4)	A(4)	A(4)	A(4)
	(10-47)%	(11-47)%	(11-46)%	(11-47)%	(12-48)%	(11-47)%	(12-46)%	(12-53)%	(12-44)%	(12-47)%
Min Edge Contrast	A(4)	A(4)	A(4)	A(4)	A(4)	A(4)	A(4)	A(4)	F(0)	A(4)
	22%	19%	19%	22%	24%	23%	22%	19%	7%	21%
Modulation	B(3)	C(2)	C(2)	B(3)	B(3)	B(3)	B(3)	D(1)	F(0)	C(2)
	61%	54%	55%	62%	66%	63%	63%	46%	23%	59%
Defects	C(2)	B(3)	C(2)	D(1)	B(3)	C(2)	C(2)	F(0)	F(0)	D(1)
	23	19	24	26	20	25	25	37	31	26
Decodability	A(4)	A(4)	B(3)	A(4)	A(4)	A(4)	A(4)	A(4)	A(4)	A(4)
	71%	71%	60%	77%	76%	76%	68%	63%	62%	68%
QuietZone	A(4)	A(4)	A(4)	A(4)	A(4)	A(4)	A(4)	A(4)	A(4)	A(4)
	(10-10)	(10-10)	(10-10)	(10-10)	(10-10)	(10-10)	(10-10)	(10-10)	(10-10)	(10-10)
Final	D(1)	D(1)	D(1)	D(1)	D(1)	D(1)	D(1)	F(0)	F(0)	D(1)

Calibration Data:

State: Not Calibrated  
Target Symbol 1 & 2 Widths: 0.24 - 0.48  
Target Rmin, Rmax: 4 - 82

Options... Save...

Click the **Save** button to save a report manually for the current symbol.

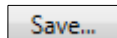

## Symbol Quality Verification Tool

Choose your folder and file name, and whether to save the report as a PDF (default) or as plain text.

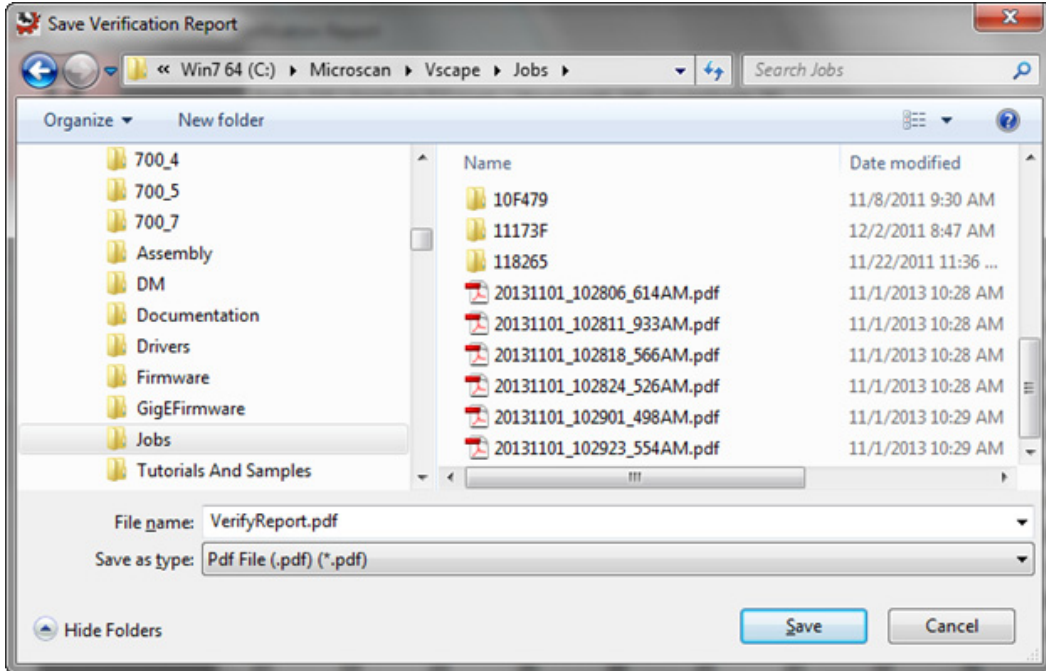

Click the **Options** button to configure various options that govern the saving of Verification reports.

[Options...](#)

The following dialog is displayed when the **Options** button is clicked:

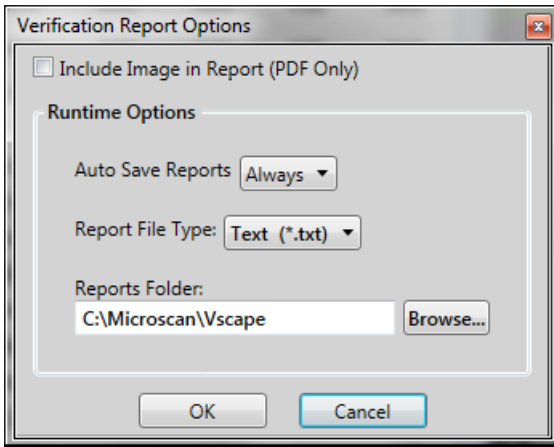

**Include Image in Report (PDF Only)** includes a bitmap of the image that was inspected. This affects both manual and auto-saved reports.

**Auto Save Reports** enables or disables auto-saving of reports when AutoVISION is in Run mode. Auto-save options are as follows:

- **Never:** Never save reports, this turns the auto-save feature off.
- **Always:** Save a report for every part that is inspected.
- **For Poor Grades Only:** A report will only be saved for symbols that receive a grade that is rated as Poor.
- **For Fair and Poor Grades Only:** A report will only be saved for symbols that receive a grade that has been rated as either Fair or Poor.

**Report File Type** selects the file type that will be used when auto-saving reports.

**Reports Folder:** Enter the path to the folder where reports will be automatically saved.

Files are auto-saved with a file name in this format:

**YYYYMMDD\_HHmms\_fff.ext**

**YYYY** = Year

**MM** = Month

**DD** = Day

**HH** = Hour (military time)

**mm** = Minutes

**ss** = Seconds

**fff** = Milliseconds

**.ext** = File extension, either .pdf or .txt, depending on the selected report format.

Example file name: **20141227\_114803\_080.pdf**

## Example Symbol Quality Verification Reports

### ISO 15416 Report, PDF Format

# MICROSCAN. ISO 15416 Verification Report

**Final Grade:** A 4.0/2.6 pixels/640/90  
**Parameters:**

	1	2	3	4	5	6	7	8	9	10
Edge Determination	A(4)	A(4)	A(4)	A(4)	A(4)	A(4)	A(4)	A(4)	A(4)	A(4)
Decode	A(4)	A(4)	A(4)	A(4)	A(4)	A(4)	A(4)	A(4)	A(4)	A(4)
Symbol Contrast	A(4)	A(4)	A(4)	A(4)	A(4)	A(4)	A(4)	A(4)	A(4)	A(4)
	100%	100%	100%	100%	100%	100%	100%	100%	100%	100%
Min Reflectance	A(4)	A(4)	A(4)	A(4)	A(4)	A(4)	A(4)	A(4)	A(4)	A(4)
	(0-100)%	(0-100)%	(0-100)%	(0-100)%	(0-100)%	(0-100)%	(0-100)%	(0-100)%	(0-100)%	(0-100)%
Min Edge Contrast	A(4)	A(4)	A(4)	A(4)	A(4)	A(4)	A(4)	A(4)	A(4)	A(4)
	100%	100%	100%	100%	100%	100%	100%	100%	100%	100%
Modulation	A(4)	A(4)	A(4)	A(4)	A(4)	A(4)	A(4)	A(4)	A(4)	A(4)
	100%	100%	100%	100%	100%	100%	100%	100%	100%	100%
Defects	A(4)	A(4)	A(4)	A(4)	A(4)	A(4)	A(4)	A(4)	A(4)	A(4)
	0	0	0	0	0	0	0	0	0	0
Decodability	A(4)	A(4)	A(4)	A(4)	A(4)	A(4)	A(4)	A(4)	A(4)	A(4)
	71%	71%	71%	71%	71%	71%	71%	71%	71%	71%
QuietZone	A(4)	A(4)	A(4)	A(4)	A(4)	A(4)	A(4)	A(4)	A(4)	A(4)
	(10-10)	(10-10)	(10-10)	(10-10)	(10-10)	(10-10)	(10-10)	(10-10)	(10-10)	(10-10)
Final	A(4)	A(4)	A(4)	A(4)	A(4)	A(4)	A(4)	A(4)	A(4)	A(4)

Reference Decode: 12345678

#### Non-Graded Parameters:

Symbol Type	Code 128	State:	Not Calibrated
Symbol Size	50	Target Symbol 1 & 2 Widths	0.24 - 0.48
Aperture	26	Target Rmin, Rmax	4 - 82
Bar Width	5		

#### Symbol Image:



**Aperture:** 2.6 pixels      **Wavelength:** 640      **Angle:** 90

Date:	12/05/2013 11:08:56
Setup Notes:	
Software Version:	Emulator
Device Name:	SoftSys1

This Report Created using Microscan AutoVISION Software  
[www.microscan.com](http://www.microscan.com)



ISO 15415 Report, PDF Format

# MICROSCAN. ISO 15415 Verification Report

Final Grade: **A** 4.0/5.8 pixels/640/90

**Parameters:**

	Grade	Score
Symbol Contrast	A	70
Modulation	A	
Reflectance Margin	A	
Fixed Pattern Dmg	A	
Axial NonUniformity	A	1
Grid NonUniformity	A	7
Unused Err Correction	A	100

Reference Decode: DMx Size 240

**Non-Graded Parameters:**

Symbol Type	Data Matrix ECC 200	State:	Not Calibrated
Symbol Size	16x16	Target Symbol 1 Width:	0.24
Cell Size	11.6 pix	Target Symbol 2 Width:	0.48
Aperture	S8	Target Rmin:	4
Print Growth	x=2, y=2	Target Rmax:	82

**Symbol Image:**

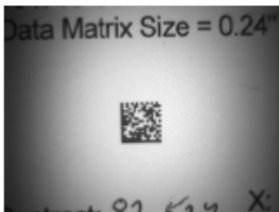

Aperture: 5.8 pixels      Wavelength: 640      Angle: 90

Date:	10/29/2013 2:36:05 PM
Setup Info:	
Software Version:	
Device Name:	SoftSys1

This Report Created using Microscan AutoVISION Software  
[www.microscan.com](http://www.microscan.com)

## **Process Control and Verification for 1D Symbologies**

This section describes the differences between process control and true verification of 1D symbols, as well as detailed verification requirements, hardware configuration, and lighting suggestions.

### **Process Control**

Simple process control requires you to decide what is necessary for your application so you can produce marks that can be read reliably.

#### **To use the camera for process control:**

- You may need to set up the camera at an angle to the part to avoid specular reflection from the built-in light.
- You may or may not need to calibrate the camera.
- You may need to turn off certain parameters in AutoVISION's **Custom Verification** editor for marks to pass.
- You may need to change exposure time and gain to create good contrast. An example is black print on dark cardboard.
- You may need to turn on **Signal Compensation**.

Process control can help ensure that you create reliable marks. They do not, however, ensure that the mark is certified against a standard.

Process control is best used to produce a grade of "Good", "Fair", or "Poor" to indicate when the marking process is out of spec for your application.

### **Verification**

Verification ensures that a mark is certified against a specific standard. The camera must be calibrated and must have correct optics and lighting. The algorithm fully conforms to the ISO standards. All verification parameters must be enabled. Marks that are verified with a fully conforming system can be sent out with a report certifying them.

#### **To achieve true verification, the following must be observed:**

- The camera must be positioned perpendicular to the surface on which the symbol is marked. See **Proper Camera and Light Configuration**.
- For linear symbols, a diffuse floodlight must be mounted at a 45° angle from the perpendicular. If anything other than 45° is used, it must be stated in the **Verification Settings**.
- The standard requires measurements to be made using the wavelength of light which the intended scanning environment will use. The wavelength must also be stated in the Verification Settings.
- The setup must be shielded from ambient light.
- The unit must be calibrated since Reflectance measurements must be expressed in percentage terms that are calibrated to a recognized international standard (i.e. a calibrated conformance test card.)

**Additional suggestions to ensure true verification:**

- True verification requires an undistorted image, so a good lens must be used. Typically this is a C-Mount lens with a high **Resolution Requirements**.
- There should be enough pixel resolution per narrow bar that the blackest value of the narrow bar is roughly equal to the blackest value of the thickest bar. The same goes for the spaces. This requires at least 5 pixels per element, preferably 8. Failure to do this will result in errors including Modulation errors. See **Resolution Requirements**.
- The floodlight must be large enough that the background and foreground gray values are perfectly even across the symbol. Failure to do this will cause problems with Modulation, but may also cause problems with Contrast and Reflectance.

**Lighting**

Optics and lighting are the key to successful 1D verification. Omron Microscan offers a number of light setups that can be used for 1D verification. The choice of the light depends on the size of the mark.

**Pharmalite Option**

For symbols up to 50 mm long, Omron Microscan offers Pharmalite. It consists of two 100 mm long rows of white LEDs and a bracket that can be mated to any Omron Microscan camera.

Pharmalite kit and cable required to power the Pharmalite using a QX-1:

**98-000228-01** KIT, SMART SERIES PHARMA, WHITE, DARK FIELD

**61-000204-01** CABLE, POWER, SMART SERIES-TO-QX-1, CONTINUOUS

**Edge-to-Edge Backlight Option**

Intended for symbols up to 100-125 mm long. The 50 x 200 mm Edge-to-Edge diffuse backlight kit consists of a light, extension cable, and power supply. Red, white, blue and infrared options are available.



***Red LED Option***

**NER-011659600G** NERLITE, 50 x 200 MM, RED, BACKLIGHT, 24V CONTINUOUS, 150 MM, M12

Extension cable and power supply:

**NER-011504100** DSP60, 24VDC, 2.5A, DIN MOUNT, POWER SUPPLY

**NER-030029100** CABLE, NERLITE, M12 CONNECTOR, 5 PIN-TO-FLYING LEADS

***MAX 300 Option***

For even larger symbols up to 200 mm long, Omron Microscan offers the MAX 300. This is a 300 mm large area array light. Its kit consists of a light, extension cable, and power supply. Red, white, and blue options are available.

Red LED option with cable required to power the light using a QX-1:

**NER-011660300G** NERLITE, MAX 300, RED, NARROW, M12 CONNECTOR

**61-000204-01** CABLE, POWER, SMART SERIES-TO-QX-1

### Proper Camera and Light Configuration

Below is the required setup for 1D verification as detailed in the ISO 15416 specification.

The correct ISO 15416 symbol verification setup includes an illumination source that is uniform across the symbol area at a 45 degree angle to the surface, and in a plane containing the illumination source that is perpendicular to the surface and parallel to the bars of the 1D symbol. The configuration also includes a camera whose axis is perpendicular to the symbol surface.

The light reflected from a circular sample area of the symbol surface is collected in a cone formation with a vertex angle of 15 degrees, centered on the perpendicular to the surface, through a circular measuring aperture with a diameter of 1:1 magnification which is equivalent to that of the sample area (the area containing the 1D symbol).

The angles of the configuration described above minimize specular reflection and maximize diffuse reflection from the symbol. This configuration is intended to provide a reference for measurement consistency.

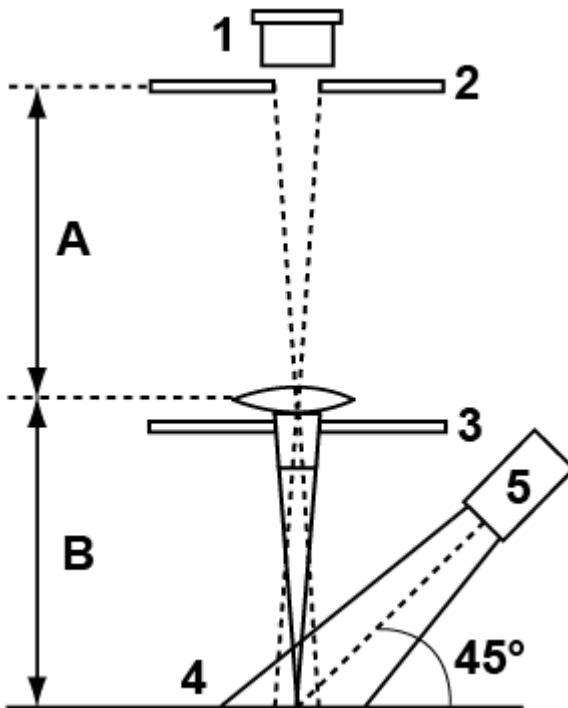

- 1 = Image Sensor
- 2 = Aperture at 1:1 Magnification (such that measurement A is equal to measurement B)
- 3 = Light Baffle
- 4 = Symbol Surface
- 5 = Illumination Source

## Resolution Requirements

Of all verification parameters, the most difficult test to pass using machine vision is Modulation. This is because the scan brightness profile typically shows narrow spaces as being less bright than wide spaces, and narrow bars as being less dark than wide bars. The reasons for this have to do with resolution, optics, focus, and lighting used for verification.

The first figure below demonstrates this problem. Gray values for wide white bars are 210-230 where they are only 150 for narrow white bars. Gray values for wide black bars are 20, while they are 60-70 for narrow black bars.

93	192	214	217	208	168	63	69	151	95	38	22	21	22	48	120
84	187	212	217	214	176	67	67	149	104	42	22	22	22	45	119
71	170	204	209	210	162	68	69	152	105	42	22	21	21	46	118
70	163	208	213	217	179	65	67	154	105	39	22	21	22	39	110
79	177	210	215	213	185	67	59	147	106	41	23	22	20	36	104
84	189	217	218	213	188	67	61	146	106	41	22	22	20	39	106
81	191	215	215	214	190	75	63	146	116	46	22	23	22	37	102
80	187	214	219	212	185	74	61	151	123	47	23	22	21	34	102
74	184	213	221	217	193	82	57	144	126	49	25	23	22	34	101

The second figure below shows how adequate resolution resolves this. Gray values for both wide and narrow white bars are 210-230. Gray values for wide and narrow black bars are 20-30.

198	220	208	211	215	219	208	207	198	169	77	42	29	26	20	24	29	23	28	51	133	182	208	213	201	178	87	45	31	32	56	133	192	204
205	224	208	210	213	218	208	209	201	173	81	45	33	30	25	29	33	27	33	57	144	193	217	218	210	193	103	57	33	32	54	131	191	205
207	222	204	207	211	217	209	211	202	173	78	41	32	30	25	29	33	27	34	59	140	188	207	204	199	190	101	50	33	30	49	126	189	204
203	215	199	206	210	217	210	211	201	168	70	31	27	25	21	24	28	22	31	57	148	194	208	201	198	193	103	48	32	27	44	122	186	202
200	213	203	216	209	217	210	212	202	168	69	30	26	25	22	24	27	22	33	60	156	197	209	202	198	190	98	44	34	29	46	124	188	203
203	215	209	228	207	216	211	214	206	174	76	37	30	30	27	29	32	27	39	67	159	196	208	205	199	182	89	39	35	33	53	131	193	206
203	214	209	230	207	216	211	214	207	175	78	40	29	30	27	29	31	26	40	69	167	201	215	220	210	185	90	47	33	34	57	135	194	205
200	208	202	224	209	217	211	213	204	172	75	36	24	25	23	25	26	22	36	66	156	187	204	213	203	171	76	38	28	31	57	135	192	202
196	210	216	229	217	219	210	215	204	167	70	36	34	30	33	24	27	34	38	69	162	200	209	209	202	173	78	45	38	36	52	141	187	214

# Color Tool



The Color Tool can be used in two ways: **Color ID** and **Color Match**.

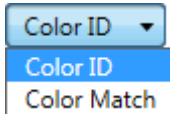

AutoVISION supports color cameras. When a color camera is selected, images will be displayed in full color.

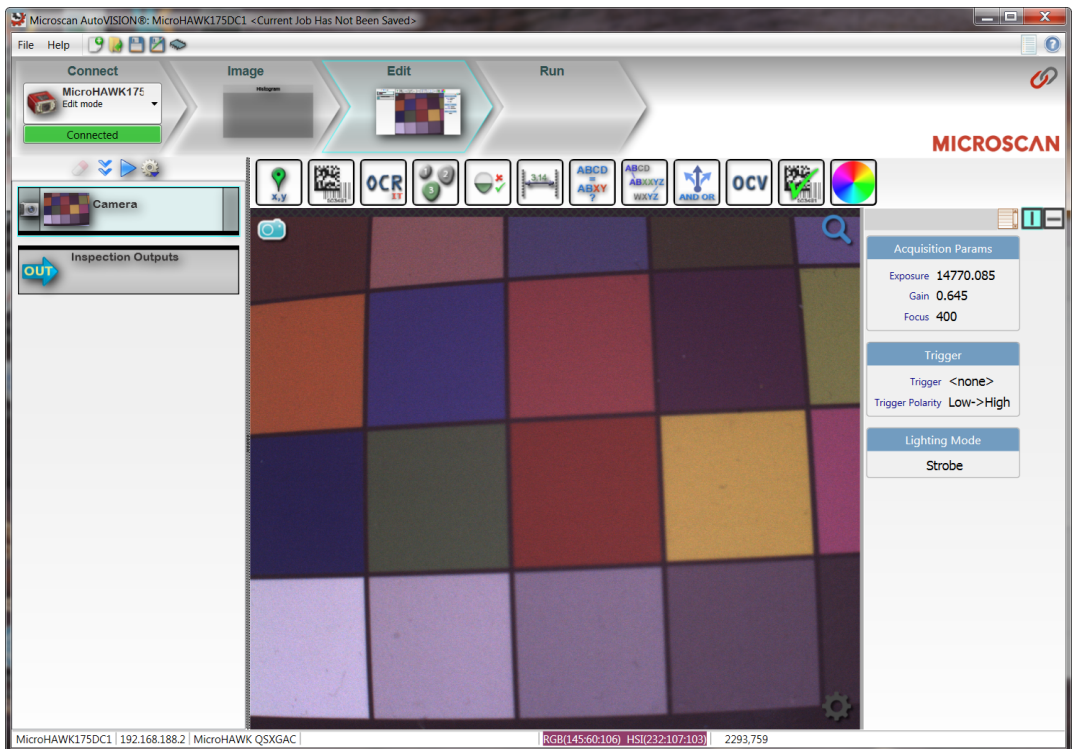

## White Balance

A toolbar in the Image view contains buttons for **Auto Calibration**, **White Balance**, **Restore Factory White Balance**, and, for Auto Focus cameras only, a **Quick Focus** button (not shown here). White Balance and Restore Factory White Balance buttons are only visible for color cameras.

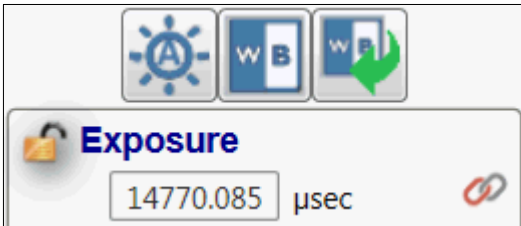

**Auto Calibration button:**



**White Balance button:**



Clicking this button will launch the Auto White Balance operation:

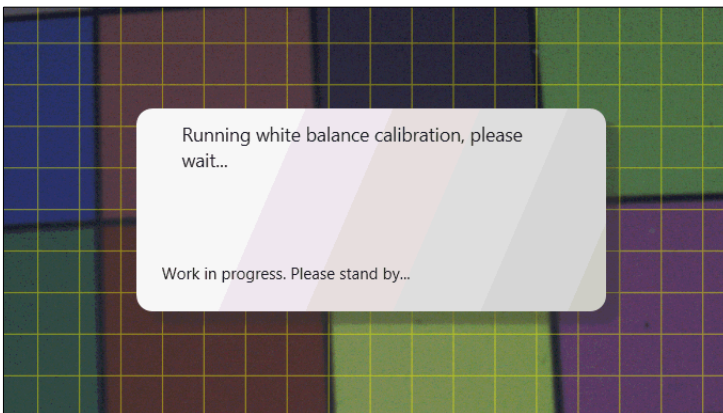

**Restore Factory White Balance button:**



Clicking this button will restore the white balance settings to factory defaults.



## Color Image Display

Images are displayed in full color. Moving the mouse pointer over a pixels in a color image will display the RGB and HSI values of the current pixel.

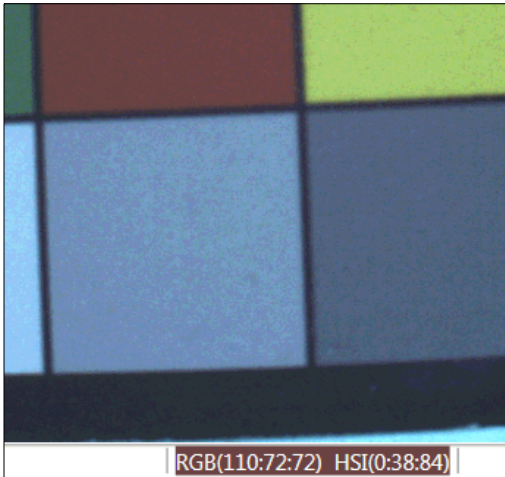

## Color Plane Display for Non-Color Tools

AutoVISION allows you to insert any standard tool into a color image (Count, Presence/Absence, Measure, etc.). These tools do not operate on color pixels, but they do operate on one of the monochrome color planes (typically luminance). The color plane is only displayed within the region of interest of the selected tool. The Count Tool is shown in this example:

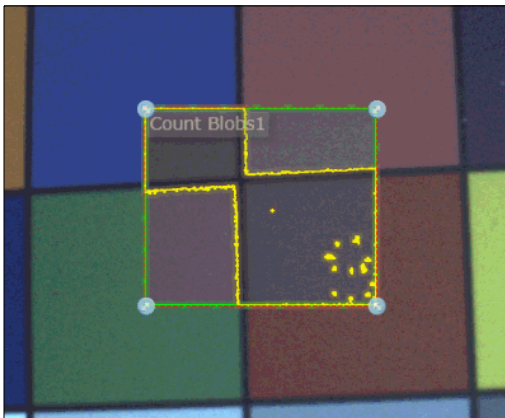

The overall image remains in color, but within the region of interest of the Count Tool, the monochrome pixels being operated on are shown.

## Color Tool Parameters

### Color ID

**Color ID** allows you to train a library of colors which is used during runtime to identify any colors present.

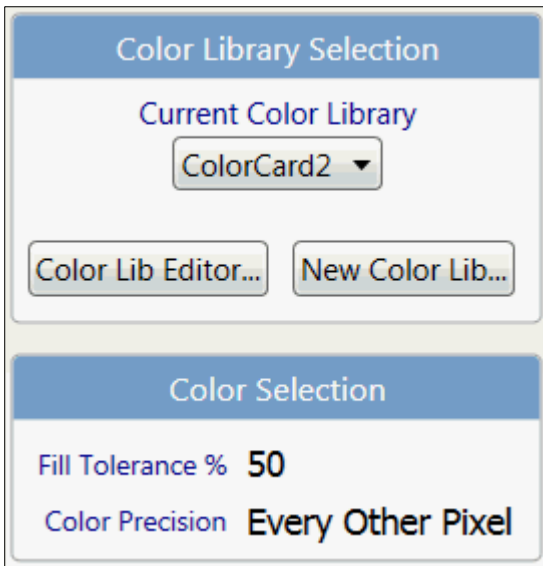

#### Color Library Selection

This editor is used to manipulate the color library that the tool will work with. It is very similar to the Font Editor in the OCR Tool.

#### Current Color Library

This displays a list of the libraries that are currently present on the PC. Color libraries are saved to the following location:

**C:\Microscan\Vescape\Jobs\Colors**

Color libraries are always stored with the extension **.color.xml**. In the example above, the library **ColorCard2** would be saved to a file named **ColorCard2.color.xml**.

#### Color Lib Editor...

Clicking this button will open up the **Color Library Editor**. This allows you to add or delete colors from the library, train those colors, and/or manually adjust the parameters of each color.

#### New Color Lib...

Click this button to create a new color library. You will be allowed to enter a name for the library. Then a file will be created with a single color, and the Color Library Editor will be opened to allow you to edit it.

## Color Selection

### Fill Tolerance

This value specifies the minimum percentage of the region of interest that must be filled with a given color in order for it to be considered a match. The color in the library with the highest fill percentage, which is also higher than this value, will be the color that is identified.

### Color Precision

This controls how many pixels you will touch within the region of interest. You can increase speed by doing a coarser search of the region of interest.

### Color Library Editor

The **Color Library Editor** dialog is launched by clicking on the **Color Lib Editor...** button in the parameter area of the Color Tool. The dialog will load the currently selected color library and will allow you to add/remove colors, manipulate the values of existing colors, and save the library when finished.

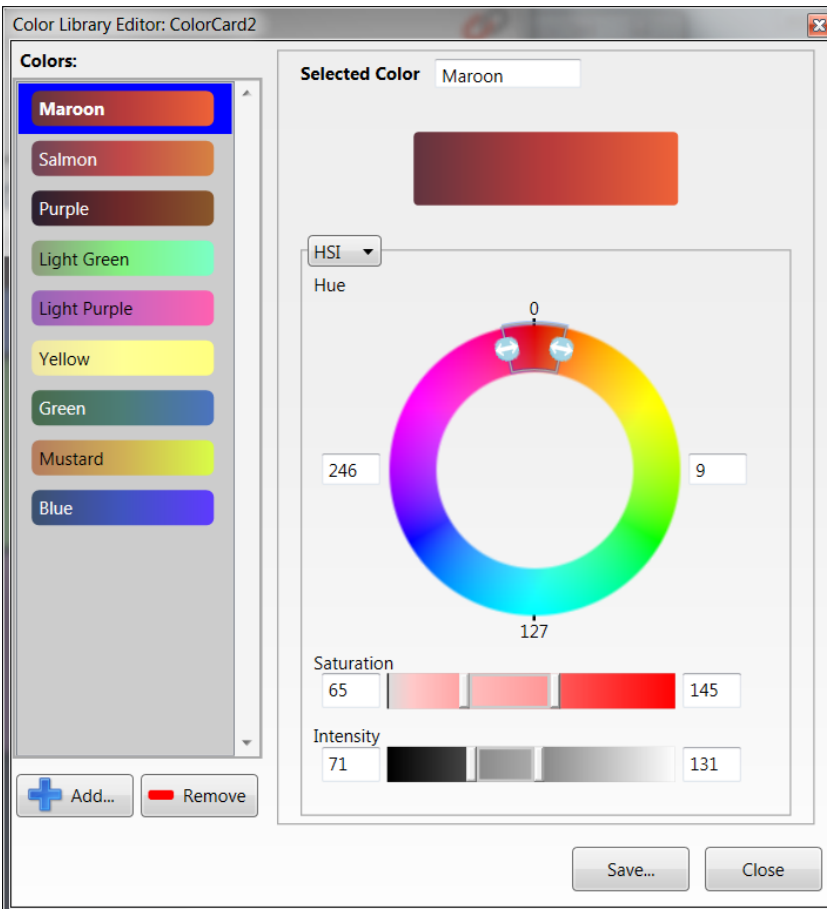

---

## Color Tool

### Colors Panel

The left panel of the dialog provides a scrolling list of the colors currently within the library. You can select any color in the list to retrain it or manually modify its settings. The **Add...** button at the bottom will allow you to add a new color. The **Remove...** button will delete the currently selected color.

### Selected Color Panel

The right panel will always show all the settings for the currently selected color. You can modify the name of the color using the text box at the top of the panel:

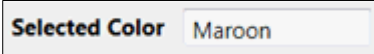

A color is specified as a range of either **Hue**, **Saturation**, and **Intensity** values, or as a range of **Red**, **Green**, and **Blue** values. This is known as the **color space**. HSI is the default color space. The dropdown menu can be used to switch to RGB if necessary.

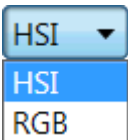

### HSI Color Space

With the HSI color space, **Hue** is represented as an angle from the origin of the color space, **Saturation** is the distance from the center, and **Intensity** is the location on the **z-axis** (the third dimension):

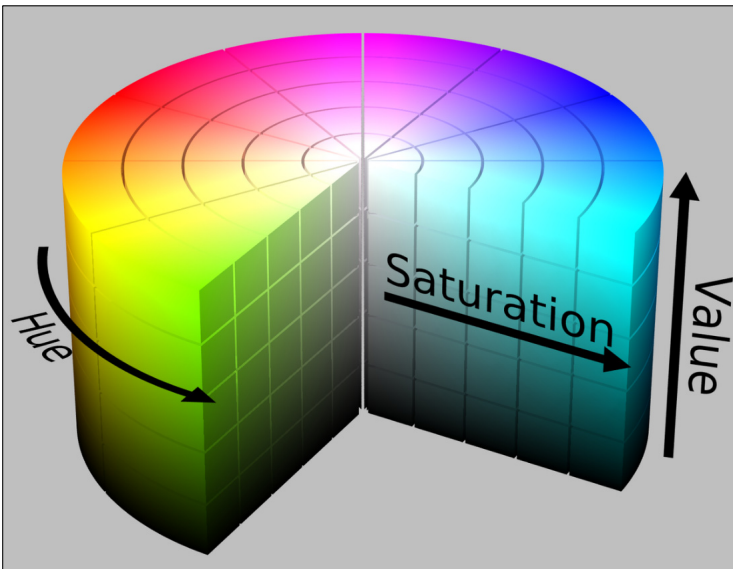

**Note:** Value = Intensity in this context.

**Hue** is represented by a color wheel, where red is at **0** degrees.

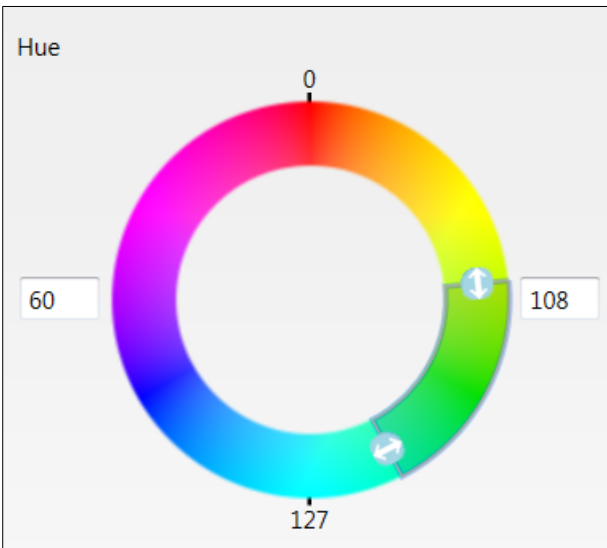

The wheel provides a user-adjustable window that can be dragged around the wheel, and re-sized (using the anchor points on either end) as a way to specify the upper and lower hue range for the current color. The text box on the left allows you to type the value for the lower range, and the text box on the right allows you to enter the value for the upper range. Note that the valid hue values are **0** to **255**, and it is allowable to have a color whose hue range crosses **0**, which is often necessary for red. Maroon is shown in this example:

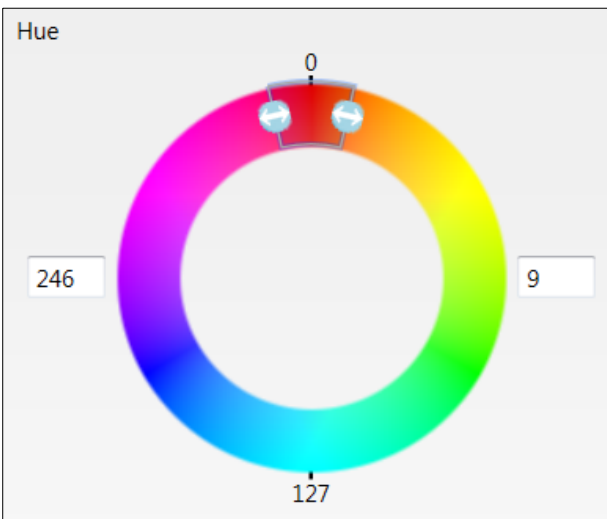

---

## Color Tool

Note that the lower range is **246** and the upper range is **9**. This may seem counter-intuitive, but these are acceptable values, as this color will produce hue values that straddle **0**, some pixels will have hues in the **246 to 255** range, and some will be in the **0 to 9** range.

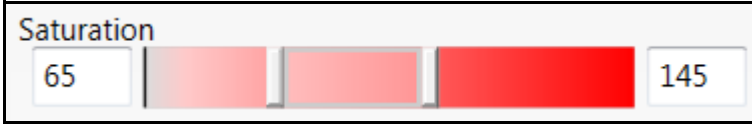

The **Saturation** slider allows the setting of an upper and lower range for the saturation value of the current color. Note that the background of the slider reflects the hue that is selected in the hue wheel. If you adjust the hue with the hue wheel, the background of the saturation slider should update to show the effect on that hue as you adjust the saturation.

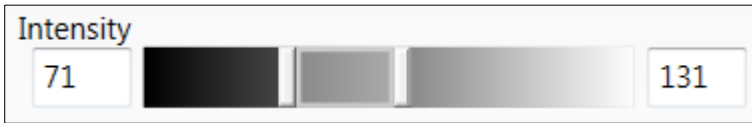

The **Intensity** slider allows you to adjust the upper and lower range of the intensity value for this color.

**Note:** When adjusting any of the HSI values, the effect of your adjustments is shown with a color gradient at the top of the panel that represents the range of your settings:

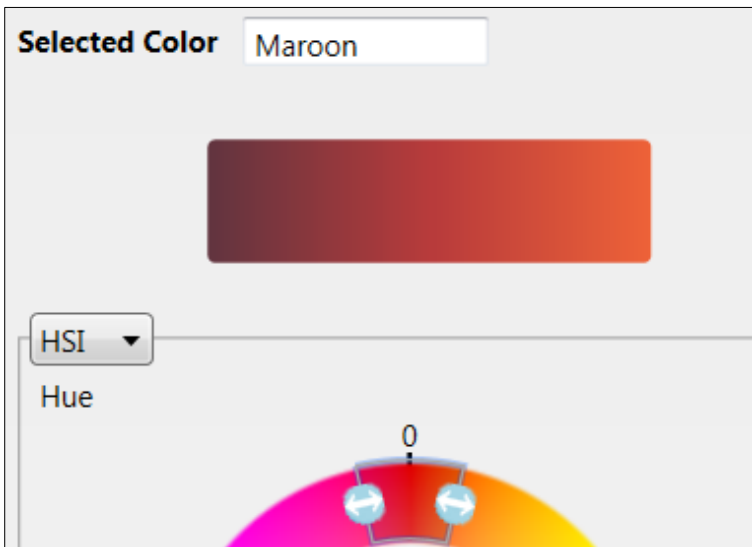

## RGB Color Space

In the RGB color space, you can adjust the upper and lower ranges for the R,G and B values.

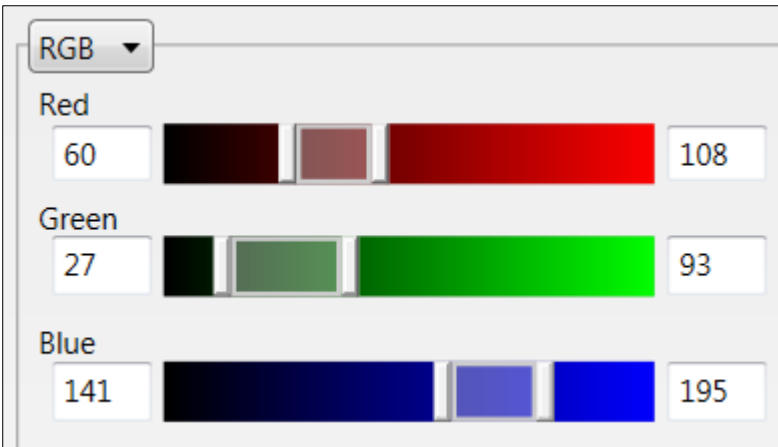

This is preferable when training on shades of gray that have no hue.

## Training a Color Value

Although you can manually set the values for a given color, it is easier to train them. When you open the **Color Library Editor**, a separate **Train Color** region of interest will show up in the image next to the region of interest for your **Color Tool**:

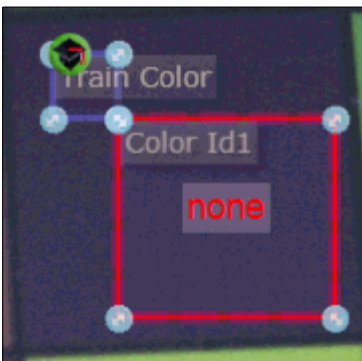

You can drag and resize this region of interest to the color you want to train, and then click the train button. The dialog will be updated to reflect the color values seen in the image. When you click the train button, the system will calculate the hue, saturation, and intensity values that occur most frequently. These values then become the center of the range. The standard deviation of hue, saturation, and intensity (or RGB) are also calculated, and the range is then set to be the center value  $\pm 3$  sigma.

---

## Color Tool

### Visual Feedback

When the **Color Library Editor** is open, the main region of interest of the tool will highlight any pixels that match the selected color. This allows you to adjust their settings, and to see how well those settings match the color.

A color that matches somewhat:

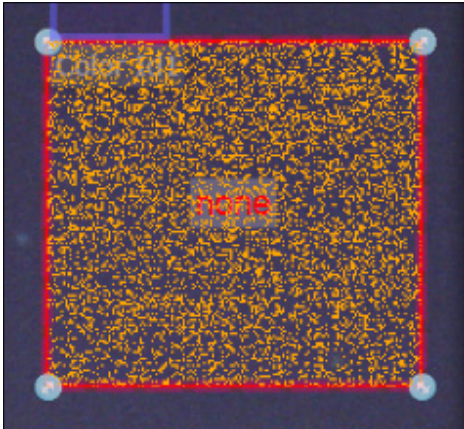

A color that matches almost exactly:

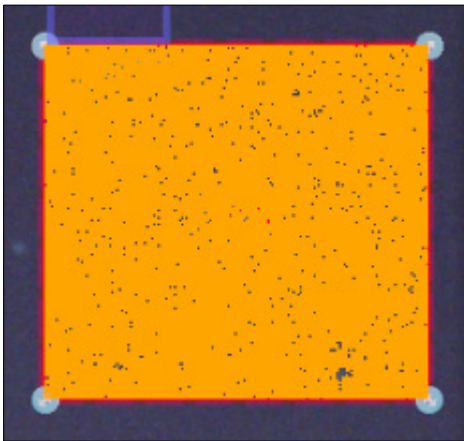



## Color Match

**Color Match** is a simpler version of Color ID, in that it does not use a library but simply allows you to train on a single color and will then pass or fail during runtime if the color matches.

### Training the Color

Similar to other tools, the Color Match region of interest has a train button (graduation cap) that can be used to train the color.

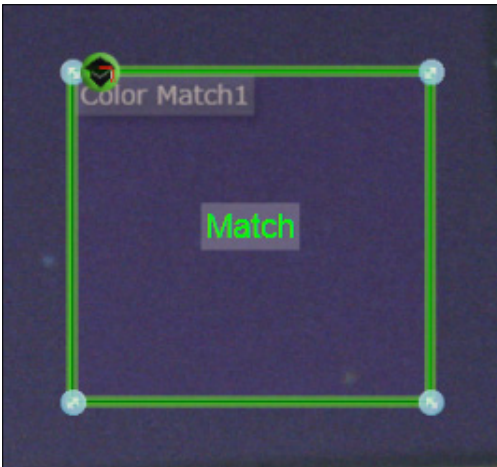

### Trained Color



Hue 160 - 240  
Saturation 35 - 115  
Intensity 45 - 111

[Color Editor...](#)

### Color Match Settings

Fill Tolerance % **50**  
Color Precision **Every Other Pixel**

---

## Color Tool

### Trained Color

Displays a graphical representation of the trained color range and shows the actual trained range for the Hue, Saturation, and Intensity (or RGB if selected).

Clicking **Color Editor...** will open the following dialog:

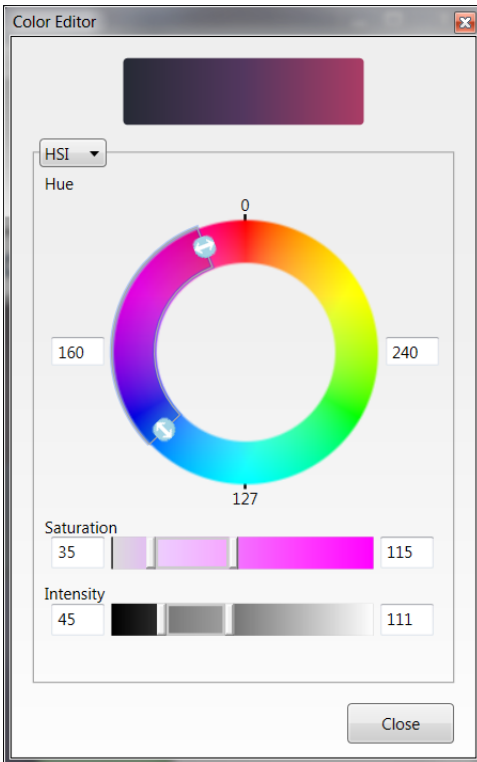

Note that this dialog is essentially the same as the dialog used to train color libraries. The only difference is that it operates on just a single color, rather than on a list of them. Use this dialog when you want to adjust the color range settings of the trained color manually.

### Color Selection

#### Fill Tolerance

This value specifies the minimum percentage of the region of interest that must be filled with a given color in order for it to be considered a match. The color in the library that has the highest fill percentage, and that is higher than this value, will be the color that is identified.

#### Color Precision

This settings controls how many pixels you will touch within the region of interest. You can increase speed by performing a coarser search of the region of interest.

# Inspection Outputs

The **Inspection Outputs Tool** is used to communicate the results of your inspection to the outside world. You can output results via Digital I/O, or as string data sent via the Serial port or the Ethernet port (via TCP/IP).

**Inspection Outputs allow you to:**

- Connect the Digital I/O of the camera to the results of your job;
- Produce a formatted string from the inspection data and send it out the Serial or Ethernet port.

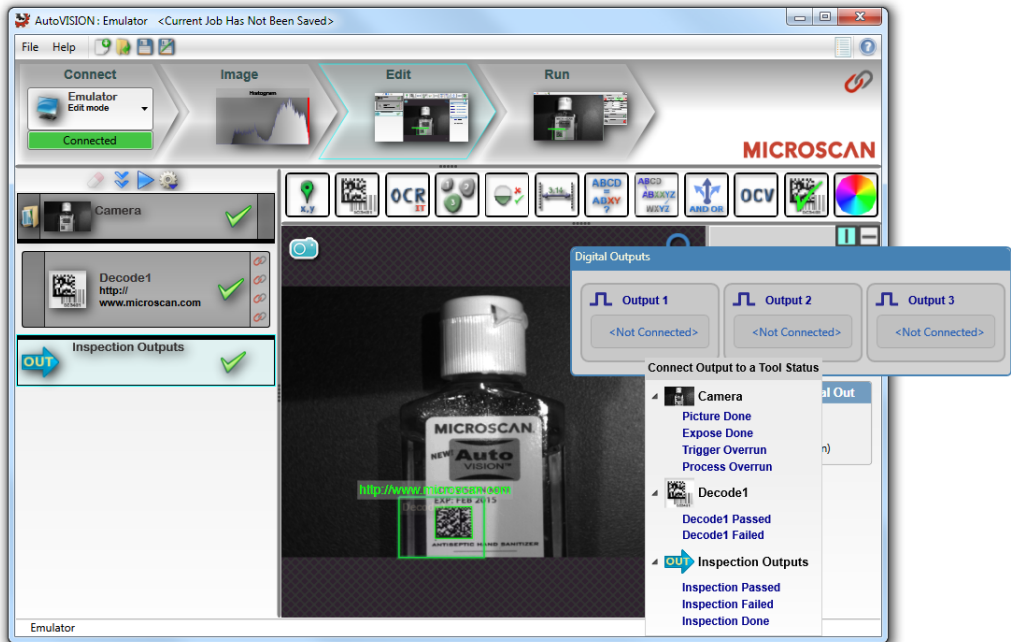

## Digital Outputs

There are three outputs (**Output 1**, **Output 2**, **Output 3**) that can be assigned to report inspection status.

**Note:** Outputs only function when a camera is connected.

Digital Outputs can be configured for all three outputs on the **Digital Outputs** tab of the **Inspection Outputs** tool.

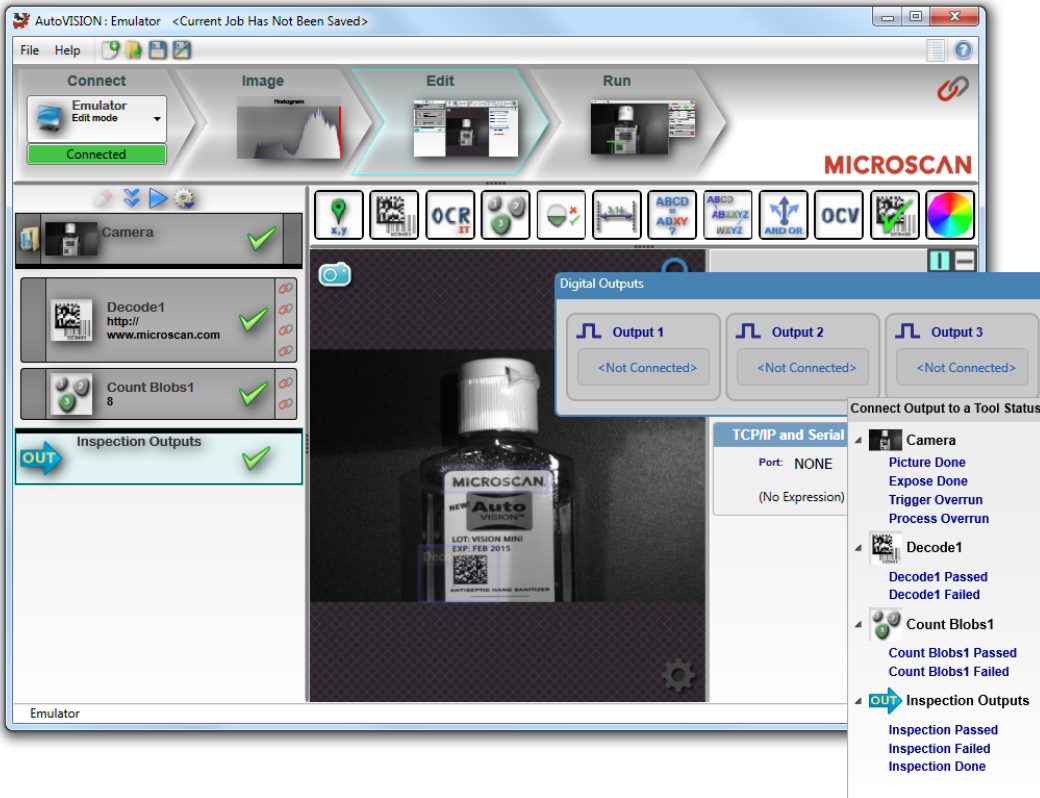

## Inspection

- **Inspection Passed:** Activates the output if the inspection passes. The pass state can be connected to any tool in the job for output.
- **Inspection Failed:** Activates the output if the inspection fails. The fail state can be connected to any tool in the job for output.
- **Inspection Done:** Pulses the I/O point at the end of each inspection cycle. The length of the pulse is user-configurable. The default pulse length is 10ms.

## Pulse Mode

When an output is connected to the state of a tool or to the overall inspection, you have the option of changing the behavior of the output via **Pulse Mode**. Output 1 is connected to the "Inspection Passed" state in the example below. This brings up the **Mode** dropdown menu.

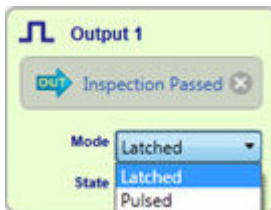

- **Latched:** This is the default. The output state is set at the end of the inspection cycle, and that state will remain latched until the end of the next inspection cycle when this output is updated again.
- **Pulsed:** The output state is set at the end of the inspection cycle and a timer is started. When the timer expires, the output is reset to its default state (**Off** if "Active High" is selected in the **State** dropdown menu, **On** if "Active Low" is selected). When **Pulsed** is selected in the **Mode** dropdown menu, a new "Pulse Width" parameter becomes visible as shown in the example below. This parameter allows you to set the width of the pulse in milliseconds.



## Active State

When an output is connected to the state of a tool or to the overall inspection, you have the option of changing the active state of the output via the **State** setting.



- **Active High:** The normal state of the output is open (low), and it transitions to a closed (high) state whenever it is activated.
- **Active Low:** The normal state of the output is closed (high), and it transitions to an open (low) state whenever it is activated.

## Camera

- **Picture Done:** The I/O point is off while the image is being acquired, on when the acquisition is complete.
- **Picture Exposed:** Turns the I/O point off while the image sensor is being exposed, and on when the exposure is complete. On an indexing machine, it is safe to move your part when the exposure is complete. Note that acquisition is not complete at this point.
- **Trigger Overrun:** Turns on to indicate an error condition in which the camera has been triggered while already in the process of acquiring an image.
- **Process Overrun:** Turns on to indicate the error condition in which the camera is being triggered at a rate that is faster than the speed of the inspection. If the camera is triggered and the previous inspection cycle has not completed, a new image will be acquired and that image buffer will be put into a queue until the camera is ready to process it. If the trigger rate is too high, the number of buffers in this queue may steadily increase until the camera eventually runs out of buffers, and this is when a Process Overrun occurs.

## TCP / Serial Output

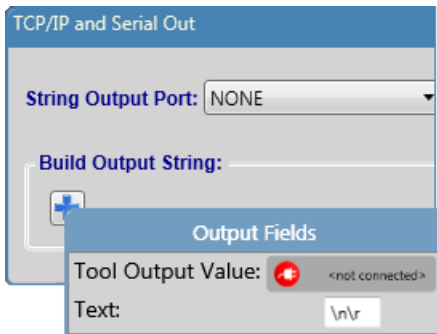

**TCP/Serial Output** options allow you to:

- Select Serial or TCP ports for output.
- Specify the decimal places for measurement tool output.
- Output up to four different tool report fields and five text fields.
- Use special non-printable characters to format TCP/Serial Output.

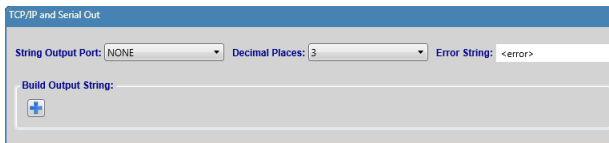

**Hint:** To reset any output string value to **Not Connected**, click the **X** to the right of the value you want to disconnect.

**Note:** When using AutoVISION's Emulator, you can use your TCP connection to view output.

### Special Non-Printable Characters in TCP/Serial Output

TCP/Serial Output accepts the following special characters, which can be used to configure the output string:

**\a** bell

**\b** backspace

**\f** form feed

**\n** new line

**\r** carriage return

**\t** horizontal tab

**\v** vertical tab

**\'** single quote

**\x022** double quote ( " )

**\?** question mark

**\ooo** three digit octal notation ASCII value, i.e. **\145** = 'e'

**\x0hh** hexadecimal notation ASCII value, i.e. **\0x04C** = 'L'

## Viewing TCP Output

When you have configured how you want data to be output over TCP, run the job in a tryout loop or click the **Run** view to begin data output.

Here is how to view output using the TCP connection and AutoVISION's Emulator:

- While the tryout loop or the job is running, open **Run** from the Start Menu in Windows.

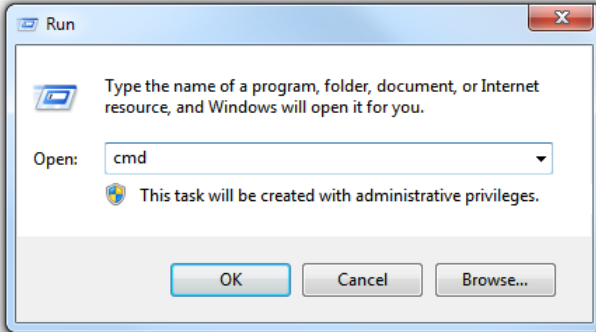

- Type **cmd** in the text field. This will bring up the Windows command line interface.

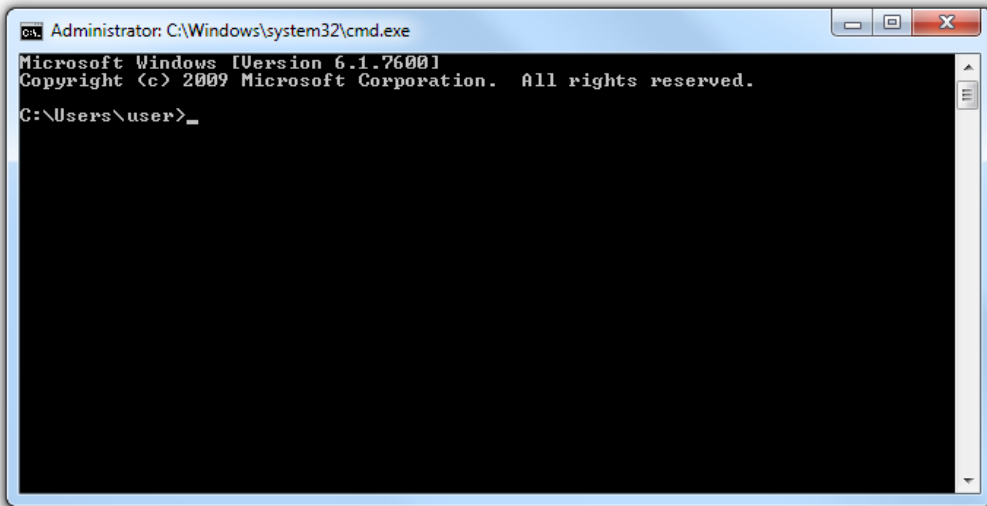



- At the prompt, type **telnet 127.0.0.1 4921x** (where 'x' = the TCP port number - for example, 49211, 49212, 49213, etc.) and **Enter**.

**Note:** 127.0.0.1 means "this computer".

**Important:** If you are connected to a camera, type **telnet [camera's IP address] 4921x** (where 'x' = the TCP port number – 49211 to 49215) and **Enter**.

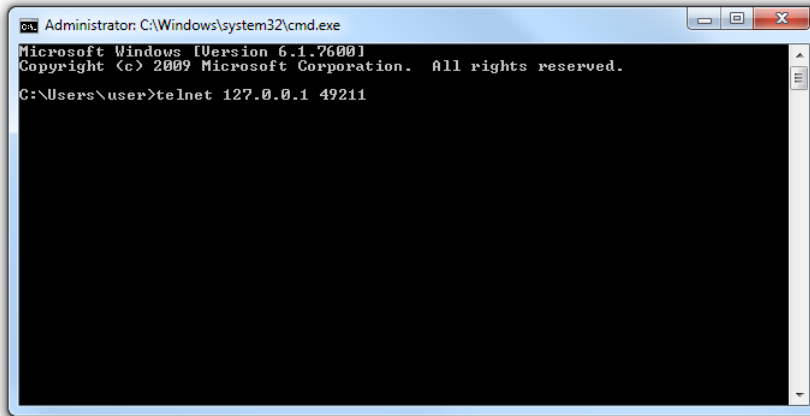

```
Administrator: C:\Windows\system32\cmd.exe
Microsoft Windows [Version 6.1.7600]
Copyright (c) 2009 Microsoft Corporation. All rights reserved.

C:\Users\user>telnet 127.0.0.1 49211
```

- After you type **Enter** you will be connected to a Telnet session that shows data output as it was formatted on AutoVISION's **TCP/Serial Output** tab.

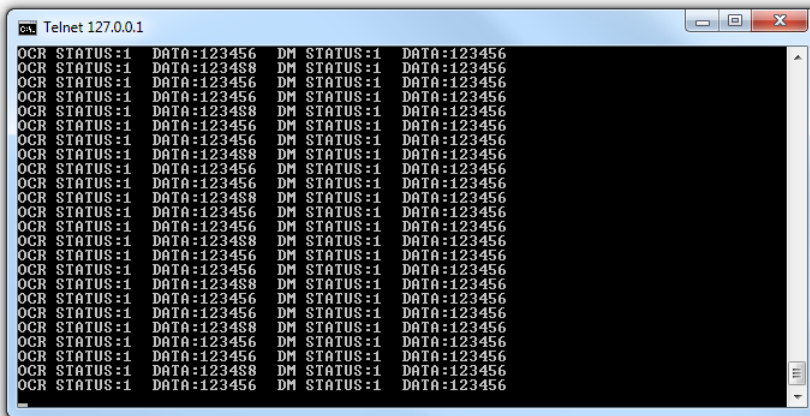

```
Telnet 127.0.0.1
OCR STATUS:1 DATA:123456 DM STATUS:1 DATA:123456
OCR STATUS:1 DATA:123488 DM STATUS:1 DATA:123456
OCR STATUS:1 DATA:123456 DM STATUS:1 DATA:123456
OCR STATUS:1 DATA:123456 DM STATUS:1 DATA:123456
OCR STATUS:1 DATA:123488 DM STATUS:1 DATA:123456
OCR STATUS:1 DATA:123456 DM STATUS:1 DATA:123456
OCR STATUS:1 DATA:123488 DM STATUS:1 DATA:123456
OCR STATUS:1 DATA:123456 DM STATUS:1 DATA:123456
OCR STATUS:1 DATA:123456 DM STATUS:1 DATA:123456
OCR STATUS:1 DATA:123488 DM STATUS:1 DATA:123456
OCR STATUS:1 DATA:123456 DM STATUS:1 DATA:123456
OCR STATUS:1 DATA:123456 DM STATUS:1 DATA:123456
OCR STATUS:1 DATA:123488 DM STATUS:1 DATA:123456
OCR STATUS:1 DATA:123456 DM STATUS:1 DATA:123456
OCR STATUS:1 DATA:123456 DM STATUS:1 DATA:123456
OCR STATUS:1 DATA:123488 DM STATUS:1 DATA:123456
OCR STATUS:1 DATA:123456 DM STATUS:1 DATA:123456
OCR STATUS:1 DATA:123456 DM STATUS:1 DATA:123456
OCR STATUS:1 DATA:123488 DM STATUS:1 DATA:123456
OCR STATUS:1 DATA:123456 DM STATUS:1 DATA:123456
```

## FTP Image Logging

To use the **FTP Step**, you need an FTP server set up on an external device. Omron Microscan recommends using the FileZilla FTP server. Install FileZilla on the repository PC and then continue below.

Enter any name you choose, and click **Finish**. This should allow FileZilla server through the windows firewall.

To configure the FileZilla server after install, click the **Edit** menu item, then **Settings**:

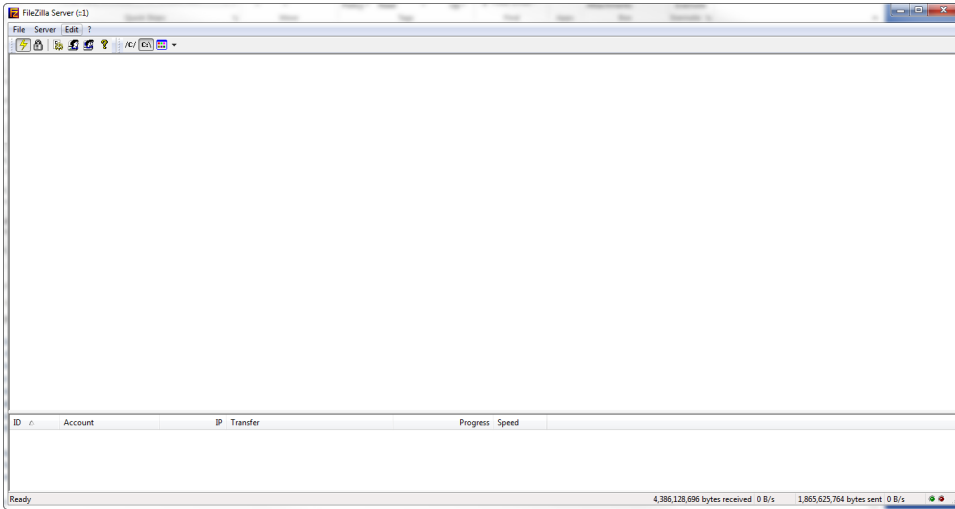

Be sure the **Listen On These Ports** is set to **21**. If you don't plan to not use the **Connect Every Cycle** option, **No Transfer Timeout** must be set to **0**. Make these changes, then click **OK**.

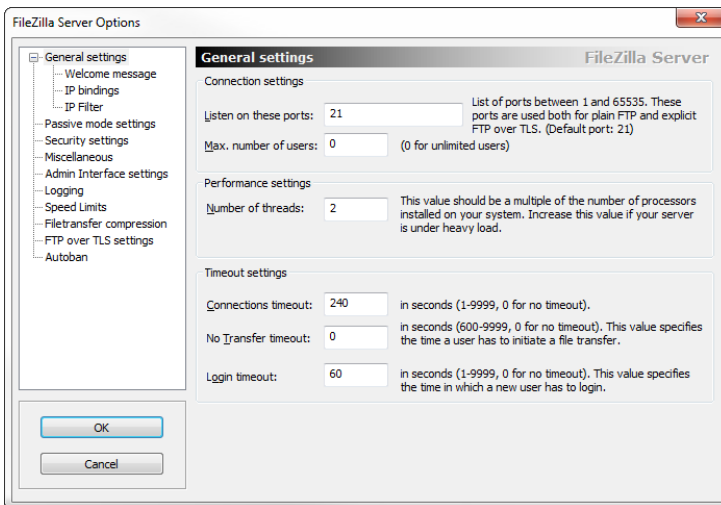

Now click **IP Bindings** and set the IP addresses to which you want to bind this server:

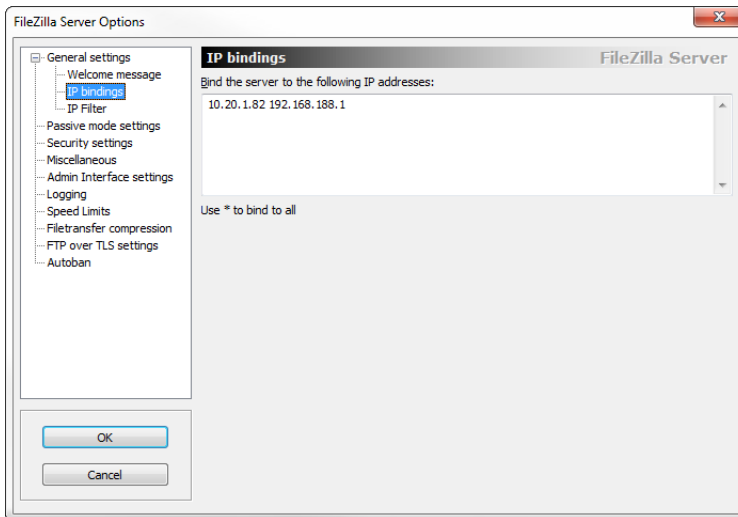

Now configure the users. Click **Edit**, then **Users**, then **Add**:

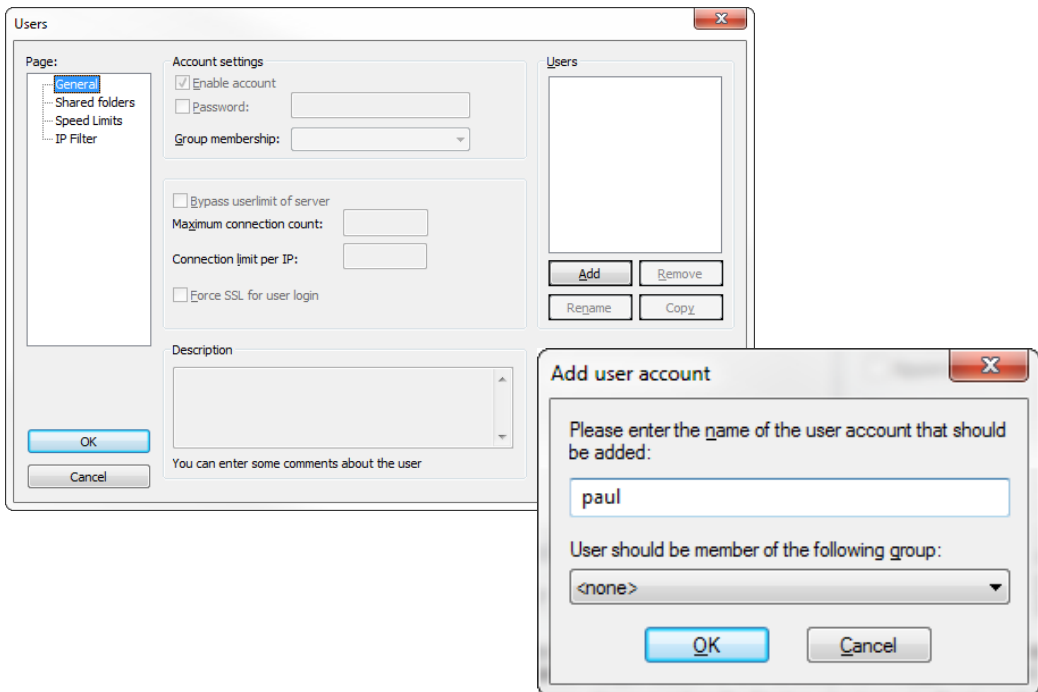

## Inspection Outputs

Click **OK**, then click on the **Password** checkbox and add a password for this user.  
Now click **Shared Folders**, then **Add**. Browse for the folders to give this user access to, then click **OK**.

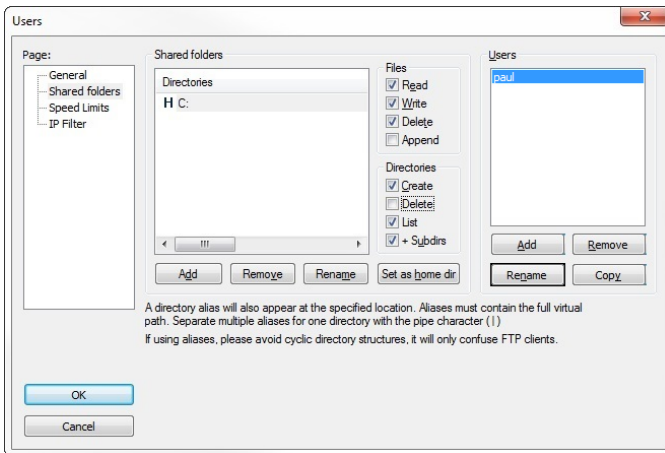
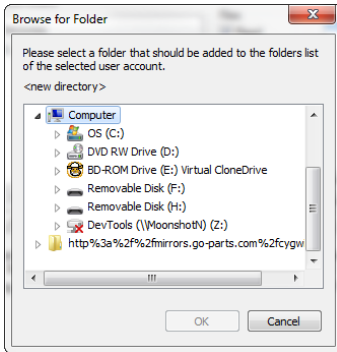
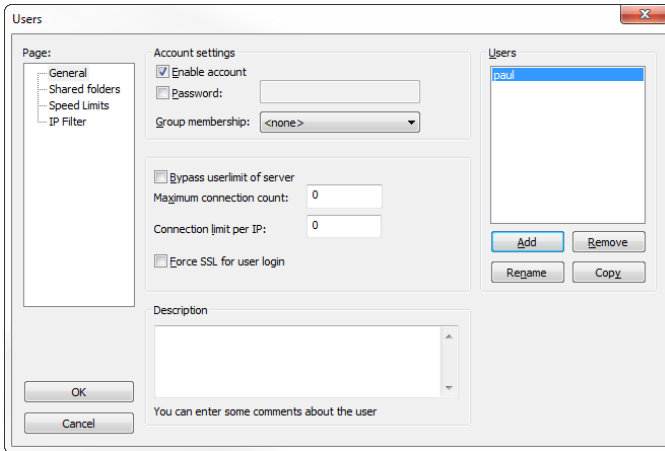

As with the Digital Outputs and the String Format Tool, FTP image transfer is available under the Inspection Outputs Tool.

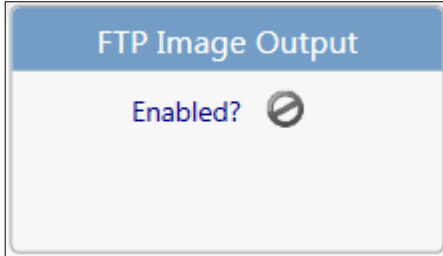

This feature is disabled by default. If you open the editor and click the **Enable** button, an FTP Output step will be added after the Digital Output steps.

The Input Buffer datum of the FTP Output step is automatically connected to the output buffer. You do not need to make this connection. The editor provides all the settings required to configure the FTP connection.

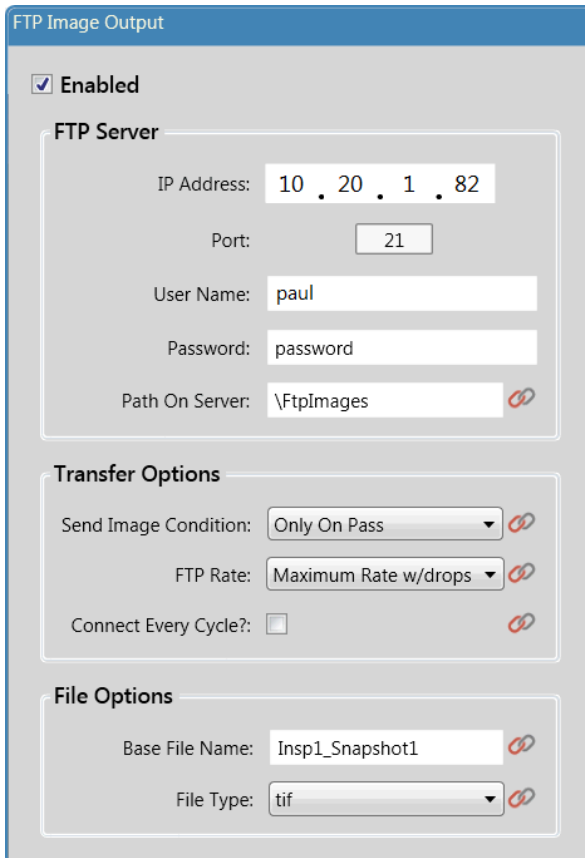
A detailed configuration window titled "FTP Image Output" with a blue header. The window contains several sections:

- Enabled:** A checked checkbox.
- FTP Server:** A section with input fields for:
  - IP Address: 10 . 20 . 1 . 82
  - Port: 21
  - User Name: paul
  - Password: password
  - Path On Server: \FtpImages (with a red link icon)
- Transfer Options:** A section with:
  - Send Image Condition: Only On Pass (dropdown menu with a red link icon)
  - FTP Rate: Maximum Rate w/drops (dropdown menu with a red link icon)
  - Connect Every Cycle?: [ ] (checkbox with a red link icon)
- File Options:** A section with:
  - Base File Name: Insp1\_Snapshot1 (text field with a red link icon)
  - File Type: tif (dropdown menu with a red link icon)

## FTP Server

These are the settings required to make a successful connection to the remote FTP server:

- **IP Address:** The IP address of the FTP server.
- **Port:** The network port to use. Default is FTP standard 21.
- **User Name:** The user name for server login.
- **Password:** The password for server login.
- **Path On Server:** The path of the destination. The default is \microscan.

## Transfer Options

These options control when an image is transferred to the server.

### Send Image Condition

Sets the condition that determines whether an image will be transferred or not at the end of a cycle. Default is **Every Cycle**, but you can also choose to send images only on an inspection failure or pass. There is also a **Never** option that can be used to disable FTP transfer entirely.

### FTP Rate

Sets the maximum frequency at which images can be transferred. This can be used to prevent an excessive number of image transfers.

### Connect Every Cycle?

By default, a connection is made to the FTP server every time the inspection is started, and disconnected every time the inspection is stopped. If this option is checked, then a connection is made to the server at the start of each cycle, and disconnected after the FTP transfer is complete. Every cycle will include a connect, send, and disconnect.

## File Options

**Base File Name:** The file name for the destination file. The default is the symbolic name for the inspection and buffer. For example, **Insp1.Snapshot1**. This will be appended with a date/time stamp when running from a PC, or a timestamp that represents time since boot when running on a camera. If you are using a color camera, this name will be appended with **-xx8-RawBayerData**, where **xx** is either **RG**, **GR**, **GB**, or **BG**, depending on the camera type. This will save an 8-bit monochrome Bayer pattern image. Appending this string allows loading of the image back into the software for viewing in color.

**File Type:** **.tif** or **.bmp**.

Once fully configured, the editor will look similar to this:

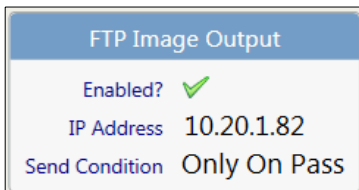

# Omron Microscan Link

AutoVISION allows you to link tool parameters to tags within the Global Data Service (GDS). This makes it possible to "set and get" the parameter values via any GDS-supported protocol, including serial, **TCP/IP**, **EtherNet/IP**, and **PROFINET I/O**.

## Link Buttons



**Link** buttons appear throughout the editing views of AutoVISION. Linkable output parameters all have an Omron Microscan Link icon displayed next to them.

### Example:

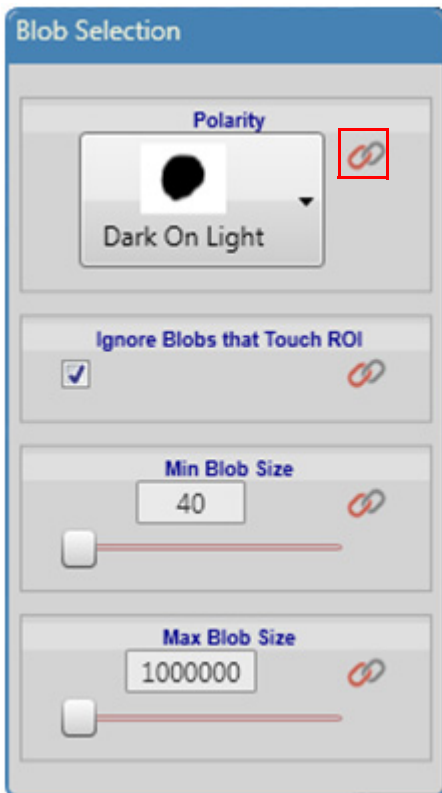

## Omron Microscan Link

Clicking a link icon displays the **Link Menu** for that parameter:

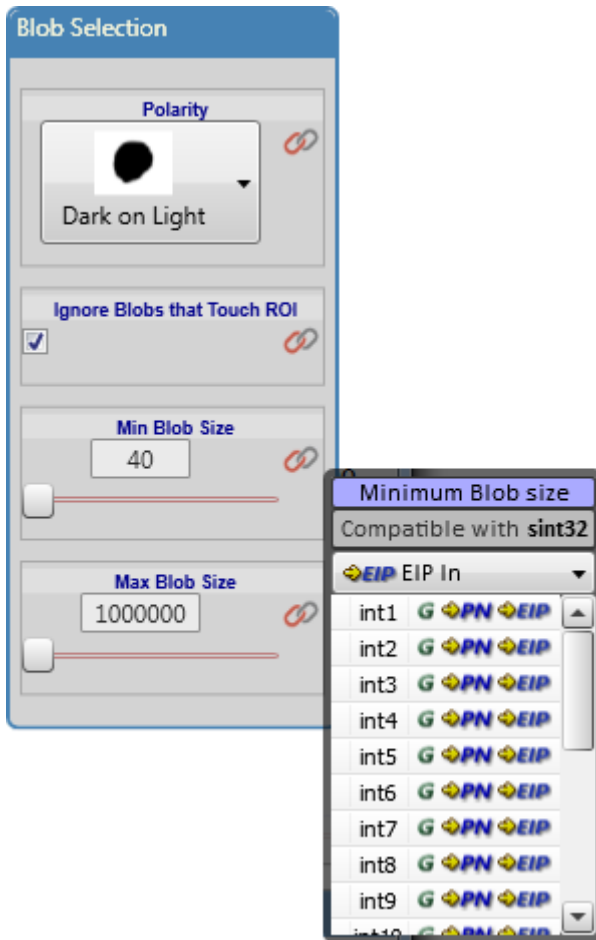

The Link Menu shows the names of compatible GDS tags. For example, the Min Blob Size parameter is an integer, so it can be linked to integers and longs.



The Link buttons for tool outputs appear in the right column of a tool within the tool list:

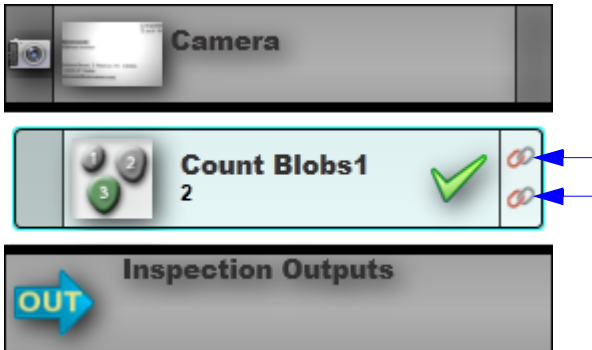

Hovering the mouse over any link button identifies its associated parameter as shown below:

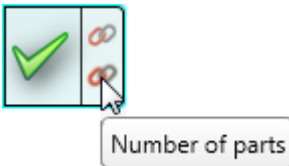

Clicking the link button displays the link menu populated with GDS tags of a compatible type. Once a parameter is linked, the background of the link button turns green:

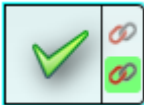

## Link Menu

The **Link Menu** displays the compatible GDS tags to which the parameter can be linked. At the top of the menu is a dropdown that acts as a filter limiting the choices available.

- The first option, **Generic**, filters the list to include all 200 Generic tags.
- The second option, **EIP In**, filters the list to include only items that can be accessed via the EIP input assembly.
- The third option, **EIP Out**, filters the list to include only items that can be accessed via the EIP output assembly.
- The fourth option, **PROFINET In**, filters the list to include only items that can be accessed via a PROFINET I/O input slot.
- The fifth and final option, **PROFINET Out**, filters the list to include only items that can be accessed via a PROFINET I/O output slot.

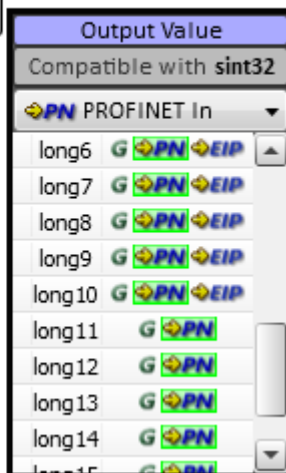
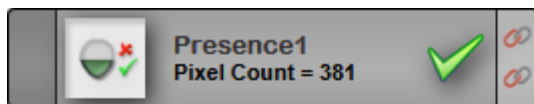
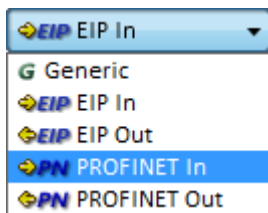

The list displays icons representing which protocols can access the particular item.

The currently active protocol – the protocol that has been enabled on the selected device – is highlighted with a green rectangle as shown above.

If the parameter has already been linked at the time the Link Menu is shown, an additional **Unlink** button appears at the top:

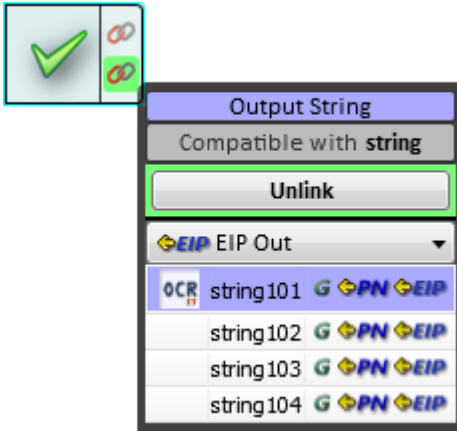

Clicking the **Unlink** button will remove the existing link.

An icon representing the corresponding tool appears next to any GDS tags that have already been linked. Hovering the mouse over the icon shows information about the tool it represents.

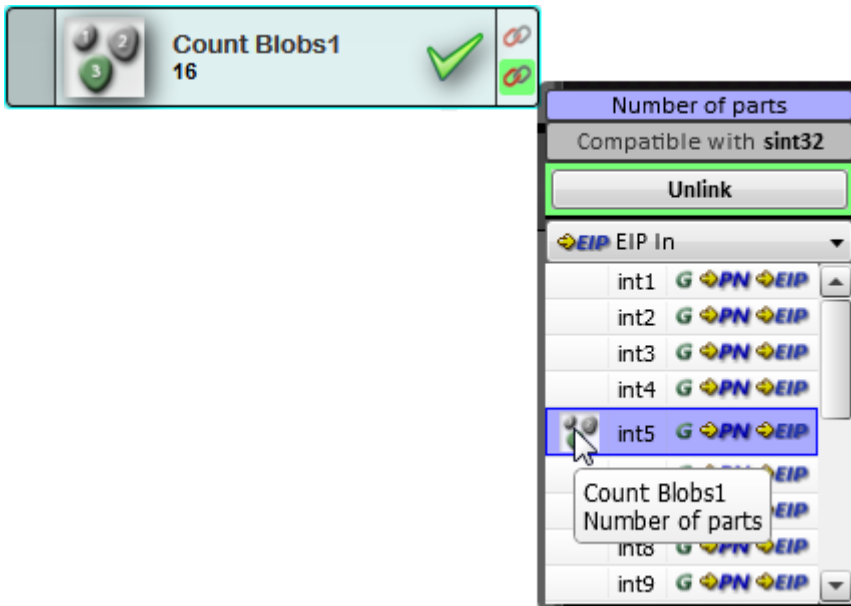

# Data Navigator

The **Data Navigator** is a utility window that can be shown by clicking the link icon shown below or by typing the keyboard combination **Ctrl + D**. It allows you to browse the information stored in AutoVISION's Global Data Service (GDS).

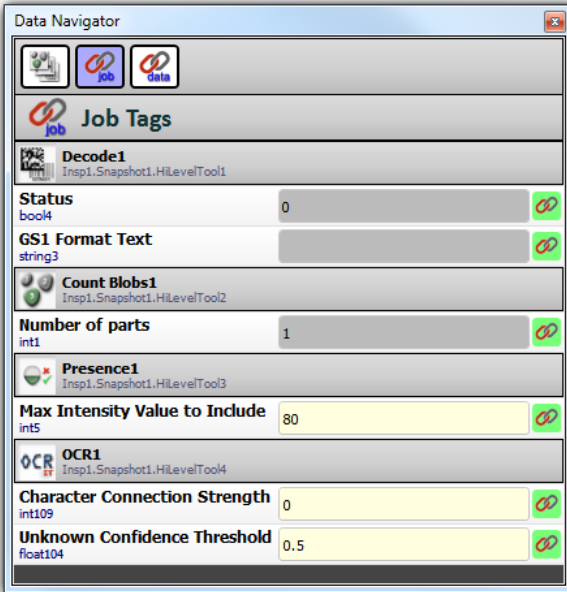

At the top of the Data Navigator are buttons that show different views.

The **Tools** button shows the GDS information for each tool in the job.



The **Job Tags** button shows a summary of the GDS links in the current job.



The **Data Tags** button shows GDS information about the various EIP services.



The Data Navigator can be shown while editing and also running a job. When displayed during Run mode, only the **Data Tags** button is visible.

## Tools View

The **Tools View** is shown when you click the **Tools** button:



This view shows a summary of all of the linkable parameters for all the tools in the job. A typical tools view is shown here:

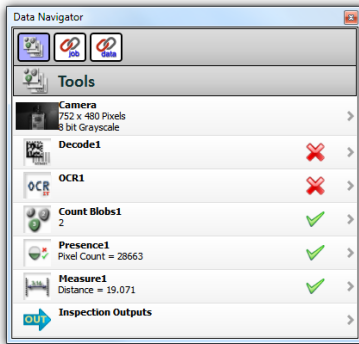

Each tool within the job is shown much as it would be shown in the tool list. For each tool, the icon, tool name, current output, status are shown. There is a right arrow button to the right of the tool status icon that allows you to "drill down" to further information about the tool. For example, drilling down on Measure1 shows the following:

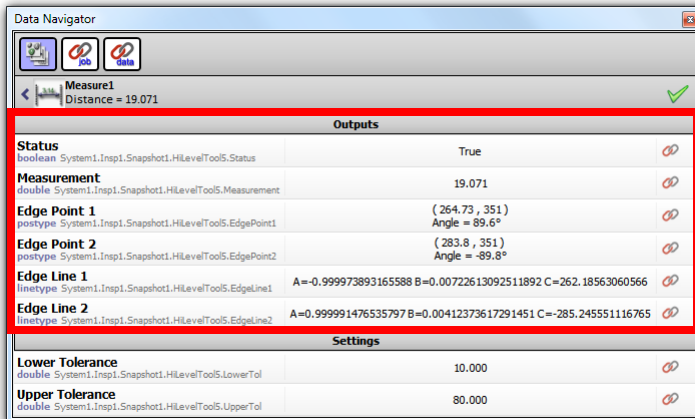

**Important:** For the Decode, OCR, Measure, and Symbol Quality Verification Tools, the Data Navigator Outputs list shows additional linkable outputs that are not shown in the main user interface. Check the Data Navigator to ensure that you are aware of all possible linkable outputs for these tools.

The header of this view shows the current tool and also a button to "drill up" or return to the previous view.

The parameters are displayed in a categorized list, along with GDS type and path information. The current value is also shown, but cannot be altered from this view. A link button is shown for any linkable parameters.

## Data Tags View

The **Data Tags View** is shown when you click the **Data Tags** button:



This view shows information from the point-of-view of the industrial protocol services. These include viewing the EIP explicit input and output assemblies, items accessible via explicit EIP messages, and items accessible via PROFINET I/O input and output slots.

A typical example is shown here:

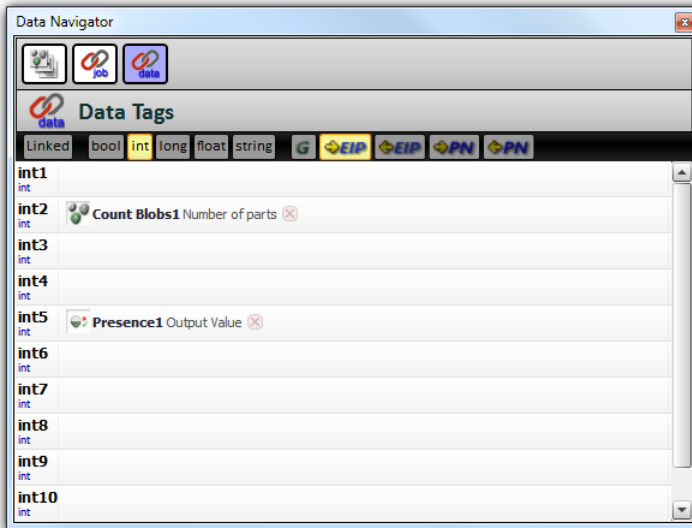

In the above example, the display is filtered to show only integers which are part of the EIP input assembly.

Each assembly item is shown along with its offset within the assembly, its size, and its links. Each of the links is shown, along with an **Unlink** button:



If more than one parameter is linked to the same location, a list of those parameters is shown:

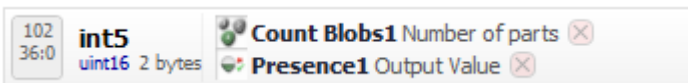

## Job Tags View

The **Job Tags View** is shown when you click the **Job Tags** button:



Each of the parameters that have been linked in the job are shown here, categorized by the tool to which they belong.

The items are displayed as follows:



Each tool that contains links is shown as a section header, along with its icon and GDS path. Within each tool section, each of the linked parameters is shown, along with its GDS path, current value, and a link button. The link button can be used as always – i.e., it displays a Link Menu with which one can change the link assignment or unlink the parameter. The value display within each item permits text entry, so a new value can be assigned to the linked parameter.

The following example shows how changing the Minimum Blob Size to **40** within the Data Navigator window writes the data to the linked parameter within the job, which then appears as the value in the parameter panel.

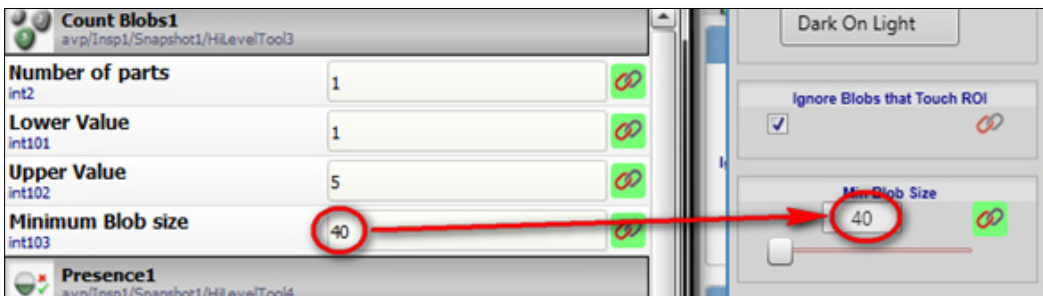

# Terminal

To access the Terminal, type **Ctrl + T** on the keyboard. The following view will appear:

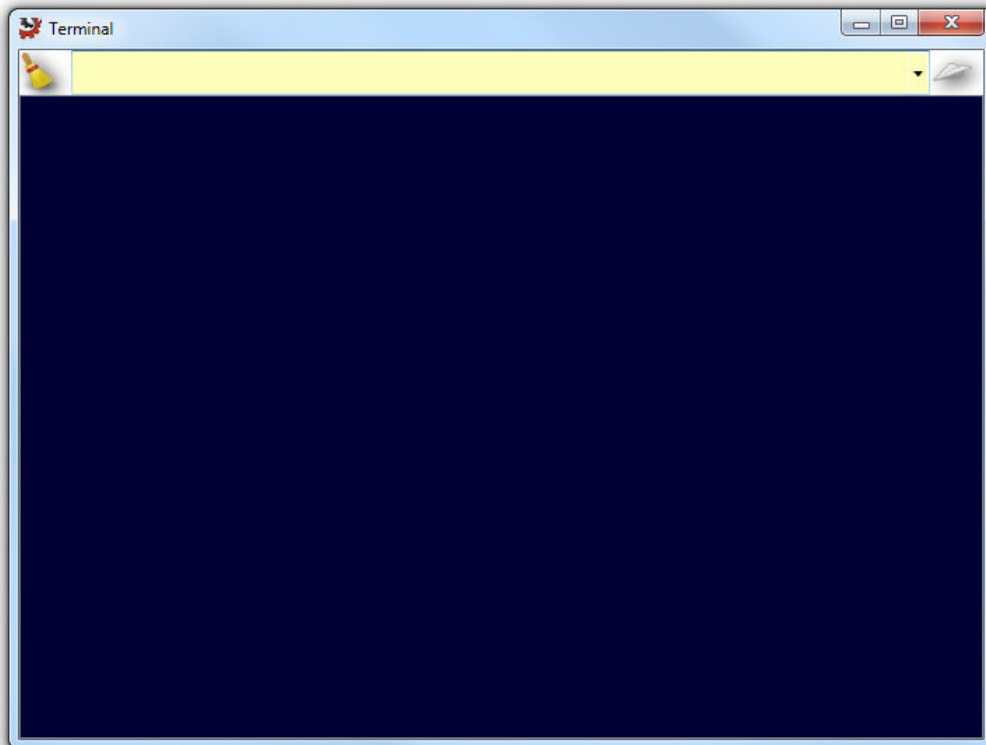

The Terminal can be used to send serial commands.

At the top of the Terminal is a field where commands can be typed. There are also two buttons:

## Clear Display



## Send Entered Command to Currently Selected Device



Typing the **Enter** key on the keyboard will also send the command.



## Setting a Match String with Terminal

Type a **SET** command followed by the string as shown below:

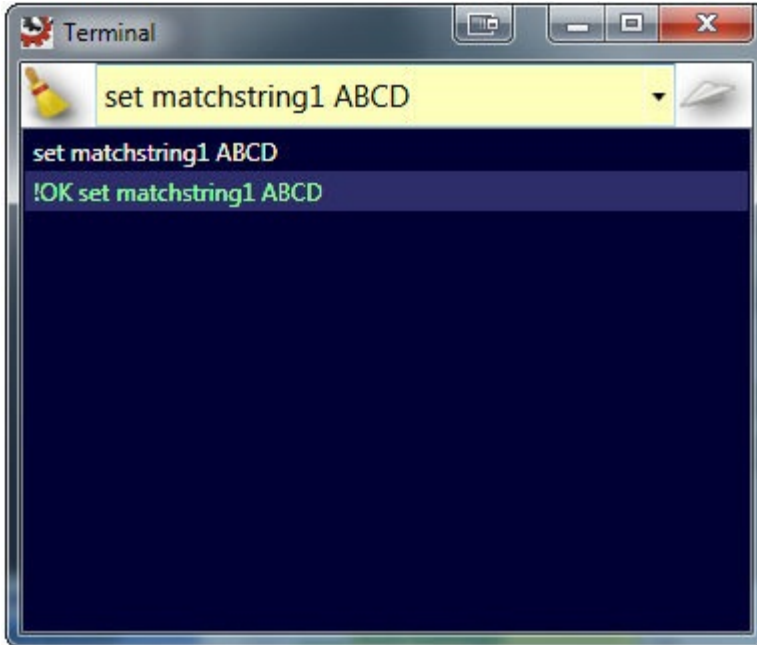

If the SET command is successful, the response will be **!OK** followed by an echo of the command.

If the command is not successful, the response will be **!ERROR** followed by text describing the error.

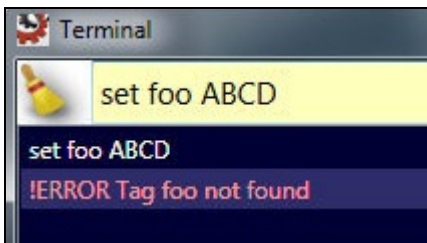

## Terminal

The following illustrates how to **GET** the value of “matchstring1”:

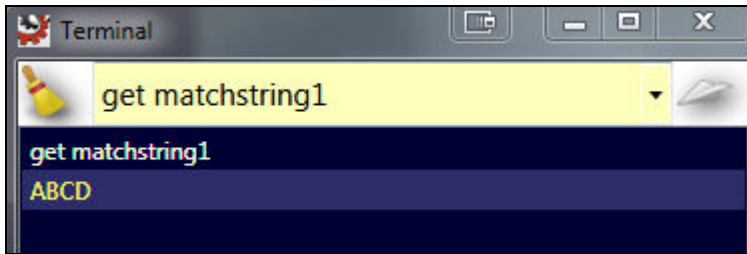

The response for a GET command returns just the value if the command succeeds. There is no beginning **!OK**, as in the SET command. However, an error condition will always begin with **!ERROR**.

The **HELP** command shows a list of the supported serial commands and their syntax:

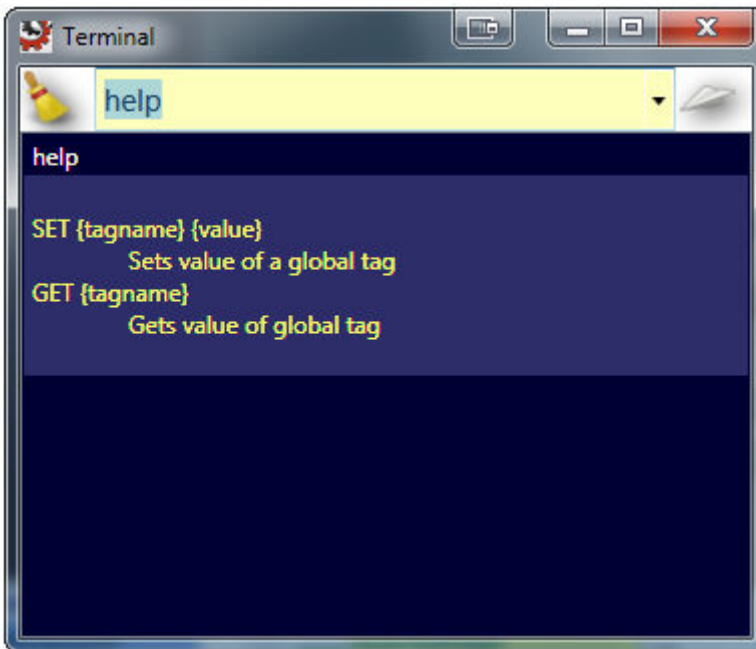

# Serial Commands

Serial commands can be sent via **TCP port**, **AutoVISION Terminal**, or **HyperTerminal**.  
**Important:** The HAWK MV-4000 Smart Camera does not support any focus commands.

## Serial Command Syntax

< > = Required argument. Replace appropriately.

For example:

**-u <DB\_User\_name>** becomes **-u av** where **av** replaces **DB\_User\_name**.

| = Mutually exclusive arguments. Choose one from the list.

{ } = Used with | to specify a list of choices for an argument.

[ ] = Optional parameter.

**Important:** Unless otherwise stated, commands will respond with **!OK** on success and **!ERROR** on failure.

## **AUTOCAL [-exp={0|1}] [-expval={60-100000}] [-gain={0|1}] [-gainval={0-100}] [-focus={0|1}] [-focval{0-9999}]**

Initiates camera calibration of gain, exposure, and focus. Each parameter is independent. Ranges are device-dependent.

**-exp enable=1** or **disable=0** autocalibrate exposure.

**-expval** value of exposure in  $\mu$ s.

**-gain enable=1** or **disable=0** autocalibrate gain.

**-gainval** value of gain in percentage.

**-focus enable=1** or **disable=0** autocalibrate focus

**-focval** value of focus in mm.

### **Example 1:**

**Command:** AUTOCAL

**Response:** 0;4632;134;50;300 (gain=0, exposure=4632  $\mu$ s, focus=134, min allowable focus=50, max allowable focus=300)

### **Example 2:**

**Command:** OFFLINE

**Response:** !OK

**Command:** QUERYAUTOCAL

**Response:** 0;4632;134;50;300 (Gain was 0.)

**Command:** AUTOCAL -exp=1 -gain=0 -gainval=18 (Fixed gain at 18%.)

**Response:** 18;3308;128;50;300 (Gain did not change and exposure has changed from 4632  $\mu$ s to 3308  $\mu$ s.)

**Example 3:**

**Command:** OFFLINE

**Response:** !OK

**Command:** QUERYAUTOCAL

**Response:** 0;3478;226;50;300 (Exposure was 3478 µs.)

**Command:** AUTOCAL -exp=0 -expval=1000 (Fixed exposure at 1000 µs.)

**Response:** 31;1000;98;50;300 (Exposure stayed at 1000 µs and gain has changed from 0% to 31%.)

**Important:** AUTOCAL only functions when the camera is OFFLINE.

### **GET {tagname|service|service.tagname}**

Gets value of a global tag.

The tagname must correspond to one of the supported tags within the device. Use the **INFO** command to get a full list of tags and services, as well as attributes of the tag and list of subtags.

The command is terminated by a carriage return and/or line feed character.

Include an index to get a single value from an array such as **GET int1**. If the index is omitted, the full array of values will be returned in a comma-separated list of values.

Send **Get {tagname|service.tagname|service}** to get the value of a tag within the global data service. To get the value of a tag within another service, prefix the tagname with the service name. For example, a **GET <service.tagname>** command such as **GET eip.input** for the EIP input assembly.

The AVP service allows retrieval of step and datum information from the job tree using forward slash '/' in the symbolic name path. **GET avp/insp1/snapshot1/status** paths are not case-sensitive and do not need to be fully qualified if unique.

**GET avp/snapshot1/status** will return the same result if there is only one inspection.

When issued against a step, **GET avp/snapshot1** will return the values for all datums.

**Success Return:** On success will return the value stored in the tag.

For example: ABCD

**Fail Return:** On failure will return !ERROR followed by the reason for the failure.

For example: !ERROR Tag matchstring66 not found

**Important:** This command only functions when the camera is ONLINE.

### **GETIMAGE <-transfer=ymodem> [-format={jpg|png|tif|raw|bmp}] [-quality ={0-100}] [-woi=left,top,right,bottom] [-inspection=n]**

Initiates serial transfer of inspection image.

**Note:** This command always returns the last (most recent) image.

**-transfer=ymodem** uses Ymodem protocol over the serial port. If the -transfer option is omitted completely, the transfer mode is over the TCP and Ethernet port.

**Important:** YModem transfer option is not supported on the HAWK MV-4000.

**-format={jpg|png|raw|tif|bmp}** specifies the format of the image. If omitted, the image format is JPG.

**Note:** For monochrome cameras, the only formats available are TIF, PNG, and JPG. For color cameras, the only formats available are RAW, PNG, and BMP.

**Note:** If BMP is selected, the system will return a PNG file.

**Note:** All image file types return complete file information that can be saved directly to disk except the RAW file type, which requires explicit conversion.

**-quality=*n*** specifies a JPG compression quality of *n* less than or equal to 100. The default quality is 80 if not specified. This setting is only supported for the JPG file type.

**Note:** PNG, RAW, TIF, and BMP formats provide lossless image compression. If **format** is set to PNG, RAW, TIF, or BMP, the **quality** setting does not apply.

**woi=left,top,right,bottom** specifies a rectangular area of the image to be included in the output image. If omitted, the full image buffer is returned.

**-inspection=*n*** specifies the inspection from which to retrieve an image. The image will be from the first snapshot within that inspection. If not specified, the image will be from the first inspection that contains a snapshot.

The following example will retrieve an image from the camera with these settings: **Protocol:** ymodem; **Format:** png; **Quality:** N/A; **Inspection:** second inspection.

**GETIMAGE -transfer=ymodem -format=png -inspection=2**

The following example will retrieve an image from the camera with these settings: **Protocol:** ymodem; **Format:** jpg (default); **Quality:** 50; **Inspection:** first inspection (default).

**GETIMAGE -transfer=ymodem -quality=50**

**Important:** This command only functions when the camera is ONLINE.

## HELP

Returns a list of all serial commands showing correct syntax and functionality descriptions.

## INFO [tagname|service]

Gets information about a tag or service.

**INFO** with no arguments gets a list of services.

**INFO <service>** gets a list of tags in that service.

**INFO <service.tagname>** gets attributes of the tag as well as a list of subtags.

The AVP service allows retrieval of step and datum information from the job tree using forward slash '/' in the symbolic name path. **INFO avp/insp1/snapshot1/status** paths are not case-sensitive and do not need to be fully qualified if unique.

**INFO avp/snapshot1/status** will return the same result if there is only one inspection.

When issued against a step, **INFO avp/snapshot1** returns properties of the step, a list of child datums, and a list of child steps. Child steps are indicated by a trailing forward slash.

## JOBBOOT [-slot=]<n>

Sets bootup job slot *n* (RS-232 only).

### **JOBDELETE** {[-slot=*n*]-all}

Deletes job in slot *n*, or all jobs if **-all**.

**Important:** Does not delete the current job loaded in camera memory.

### **JOBDOWNLOAD** <-transfer={ymodem|ftp}> [-size=value] [-c]

**Important:** JOBDOWNLOAD only supports FTP on the HAWK MV-4000.

Downloads a **.avz** job file via the specified transfer method (ymodem supported only over RS-232; FTP supported only over network connection).

The **ymodem transfer method** only requires that the user send the **.avz** file via the ymodem protocol over RS-232, and the job will load automatically after the transfer is complete.

The **FTP transfer method** requires the user to perform the following steps to load the job:

- **JOBDOWNLOAD: -transfer=ftp [-size=avpsizeinbytes]**

Pre-creates a fixed-size /streamd0 RAMdisk to receive the **.avz** over FTP. If size is omitted, the default RAM disk size is used to create /streamd0. The size of /streamd0 is limited to (available contiguous RAM – minimum target contiguous RAM) / 2.

- User FTPs the job to /streamd0
- **JOBLOAD: -mem -r**

Loads **.avz** from /streamd0 into RAM, deletes the RAMDisk /streamd0, and optionally starts the job (if **-r** is specified).

### **JOBINFO** [[-slot=*n*] [-v]

Gets job summary or info about slot *n*.

**JOBINFO** with no arguments returns a list of all jobs on the device.

**-v** = Verbose *n*. This option shows the amount of space that would be freed if the job were deleted. It also lists the total disk space and free disk space.

### **JOBLOAD** {[-slot=<*n*>|-mem} [-r]

Loads a job from slot *n* or from memory when used with the JOBDOWNLOAD command via FTP.

**-r** = Start inspections.

### **JOBSAVE** [-slot=<*n*>

Saves current job to slot *n*.

### **MEMAVAIL** [-cp]

Returns available memory for device or coprocessor.

### **MEMCONTIG** [-cp]

Returns maximum memory block for device or coprocessor.

## MEMFRAGS [-cp]

Returns memory fragments for device or coprocessor.

**Important:** MEMFRAGS is not supported by the HAWK MV-4000. It will return **!ERROR**.

## MEMINFO [-cp] [-v]

Returns memory summary “avail/contig/frags” for device or coprocessor. Verbose.

## OFFLINE

Stops all inspections.

## ONLINE

Starts all inspections.

## ONLINE?

Queries the camera if any job is online. If the camera is running in a multi-inspection job, this command will return **1** if all inspections are online and **0** otherwise.

## QUERYAUTOCAL

Returns photometry settings: Gain, Exposure, and Focus.

## QUERYFOCUSUNITS

Queries the units being used for autofocus, mm (0) or inches (1).

## QUERYWHITEBAL

Returns white balance settings: RED gain, BLUE gain, and GREEN gain.

## QUICKFOCUS [x] [y]

Performs an autofocus by analyzing the area around the point specified by **x** and **y**.

The response is in the format of the camera’s current focus, min. allowable focus on the camera, max. allowable focus on the camera.

### **Example:**

Perform a quick focus on point (640,480) in the image.

**Command:** QUICKFOCUS 640 480

**Response:** 124;50;300 (Current focus is set to 124 mm with an allowable focus range of 50 – 300 mm on the current camera.)

**Important:** This command only functions when the camera is OFFLINE.

## READY? [-insp=n]

Queries if inspection is waiting for a trigger. **!1** if all inspections are ready or **!0** if not all inspections are ready.

**-insp=n** specifies the inspection to query if it is ready.

## REBOOT [-noload]

Reboots the device.

-noload = do not load BOOT job.

## RESTOREWBAL

Restores preset white balance parameters: RED gain, BLUE gain, and GREEN gain.

## SET <tagname> <value>

Sets value of a global tag.

The tagname must correspond to one of the supported tags within the device. Use the **INFO** command to get a full list of tags and services, as well as attributes of the tag and list of subtags.

The value can contain spaces.

The command is terminated by a carriage return and/or line feed character.

The value can be a list of comma-separated items to set a sequence of tags:

Send **SET int1 1, 2, 3** to set int1 = 1, int2 = 2, int3 = 3.

The AVP service allows setting of step and datum information from the job tree using forward slash '/' in the symbolic name path. **SET avp/insp1/snapshot1/acq1/gain 2.0** paths are not case-sensitive and do not need to be fully qualified if unique.

**SET avp/acq1/gain 2.0** will set the same gain value if there is only one acquire.

Control tags in the AVP service such as **START**, **STOP**, and **TRIGGER** act as momentary switches. **SET avp.start 1** is equivalent to the **ONLINE** command. **avp.start** will reset immediately and always read as **0**.

**Success Return:** On success will return **!OK** followed by an echo of the command.

For example:

```
!OK SET matchstring1
```

**Fail Return:** On failure will return **!ERROR** followed by the reason for the failure.

For example:

```
!ERROR Tag matchstring66 not found
```

## SETFOCUSUNITS

Sets units used for autofocus, **mm (0)** or **inches (1)**.

**Important:** The MicroHAWK MV-40 only supports mm so SETFOCUSUNITS will only accept **0** and anything else will respond with **!ERROR**.

## TARGET {0|1|off|on}

Turns targeting LEDs On or Off.

**target 1** = Turn Target On

**target 0** = Turn Target Off



## **TRIGGER**

Triggers an inspection.

## **VERSION**

Returns Visionscape software version.

## **vt [n]**

Triggers an inspection by pulsing a Virtual I/O point.

For example: **vt 1**

will return pulse **VIO1**. The inspection will run if it is configured to use **VIO 1** as a trigger.

If specified, the VIO index must be in the allowed range for Virtual I/O points within Visionscape. The virtual I/O line will be set high then low.

If VIO Index is not specified, VIO1 is assumed.

**Fail Return:** Return **!ERROR** followed by the reason for the failure.

For example: **!ERROR No such trigger** when the index specified 'n' is out of range of virtual triggers.

## **WHITEBAL**

Performs automatic calibration of white balance settings: RED gain, BLUE gain, and GREEN gain.

**Important:** This command only functions when the camera is OFFLINE.



# 5 Run

## **Contents**

Run Overview .....	5-2
Image Display Options .....	5-3
Image Saving Options .....	5-4
Inspection Statistics .....	5-5

This section describes the various elements of **AutoVISION's Run** view.

# Run Overview

The **Run** view is a monitoring interface with real-time information, the ability to save images, and the ability to configure how images are displayed.

This view allows you to monitor current inspection status, and features image saving options (**Save No Images**, **Save All Images**, **Save Failed Images**, or **Save Passed Images**) as well as image display options.

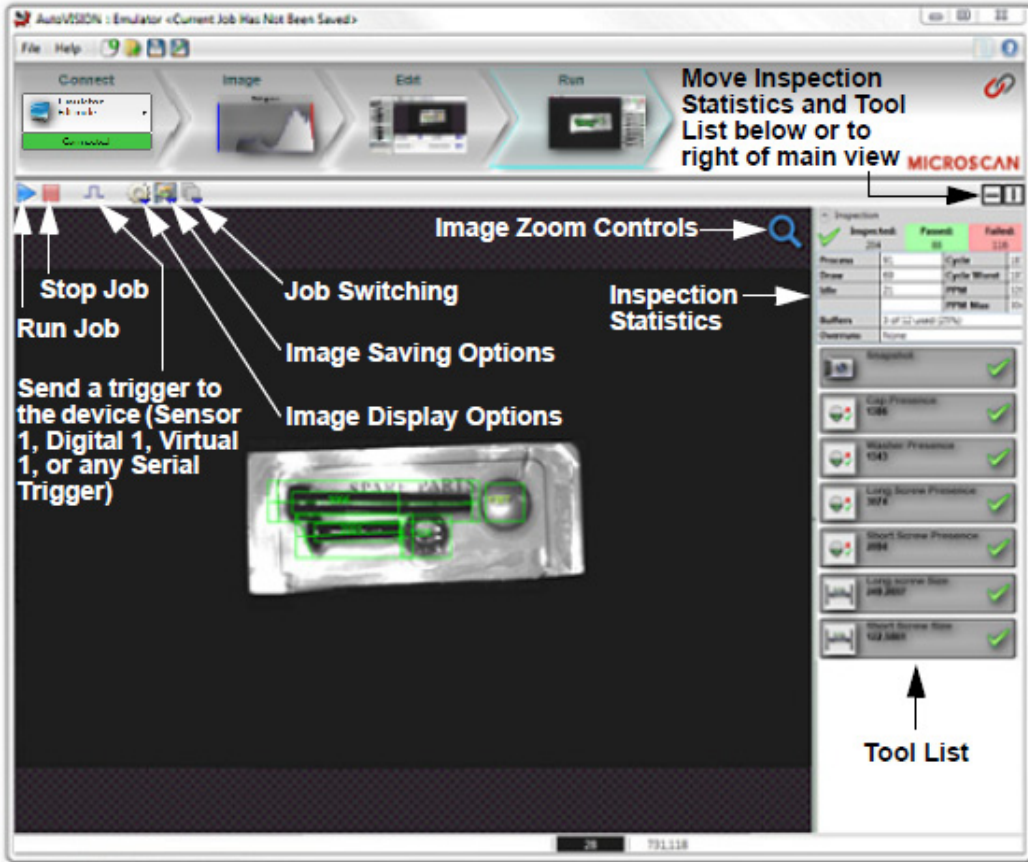

The following sections describe **Image Display Options** and **Image Saving Options** in greater detail.

**Important:** Triggering from AutoVISION is intended for testing only and results in significant processing time variation. Use the actual trigger source for actual timing values.

# Image Display Options



**Image Display Options** allow you to choose which images to display and how to display them. You can also determine how many images to display per second, or choose to show tool graphics (boundary ROIs or OCR characters, for example).

Show Tool Graphics

---

**Image Display**

Show All Images

Show Only Failed Images

Freeze Display on Current Image

Freeze Next Failed Image

Freeze Last Failed Image

**Display Speed**

Maximum Rate, drop images when PC is busy

2 Images Per Second

4 Images Per Second

8 Images Per Second

Every Image (no drops)

# Image Saving Options



**Image Saving Options** allow you to determine which kinds of images to save and where to save them. Select the folder where you want to save the images on your PC, and choose whether you want AutoVISION to save no images, all images, only failed images, or only passed images. You can also choose whether to display the images with graphics that show results of tool processes (boundary ROIs or OCR characters, for example) or to save the images without those graphics.

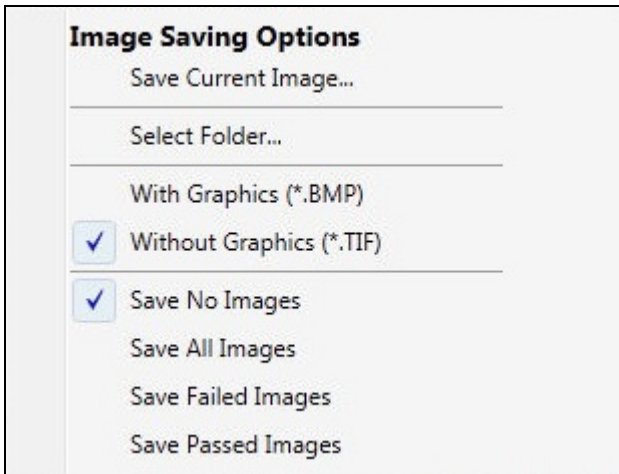

**Note:** **Save No Images** is selected by default at startup.



# Inspection Statistics

The **Run** view provides the following statistics:

- **Inspection Counts:** Displays the number of parts inspected, passed and rejected;
- **Inspection Timing Statistics:** Displays statistics on the speed of your inspection;
- **Tool Results:** Shows the Pass/Fail status and inspection data from each of your tools.

Inspection 			
	<b>Inspected:</b> 6191	<b>Passed:</b> 6191	<b>Failed:</b> 0
<b>Process</b>	6	<b>Cycle</b>	7
<b>Draw</b>	0	<b>Cycle Worst</b>	7
<b>Idle</b>	1	<b>PPM</b>	8571
		<b>PPM Worst</b>	8571
<b>Buffers</b>	2 of 16 used (12%)		
<b>Overruns</b>	None		





# ■ 6 *Firmware and License Upgrades*

## **Contents**

Updating Firmware .....	6-2
Camera License Upgrade .....	6-6

This section describes how to upgrade your camera's firmware using **AutoVISION's Device Firmware Update** feature, and how to upgrade your camera for use with Omron Microscan's **Visionscape** software.

# Updating Firmware

AutoVISION's simple **Device Firmware Update** feature makes it easy to download and install firmware on your camera.

To download and install firmware:

- Navigate to **Windows Start Menu > Programs > Omron Microscan AutoVISION > Device Firmware Update**.

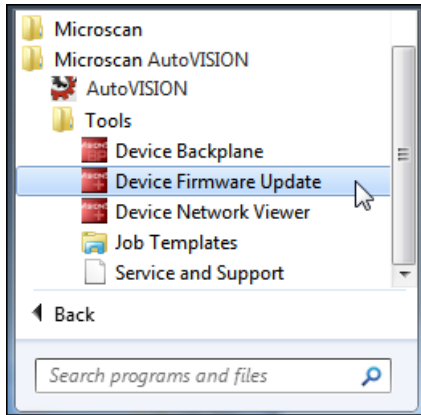

- After you click **Device Firmware Update**, the **Smart Camera Firmware Update Tool** will appear. Select your camera from the **Please Select a Smart Camera to Update** dropdown menu.

**Note:** Only cameras on the same network as your PC will be visible in this menu.

- Once you have selected your camera, its identifying details, such as **Model**, **Firmware Version**, **MAC Address**, **IP Address**, **Status**, and **PC Version** will be displayed.

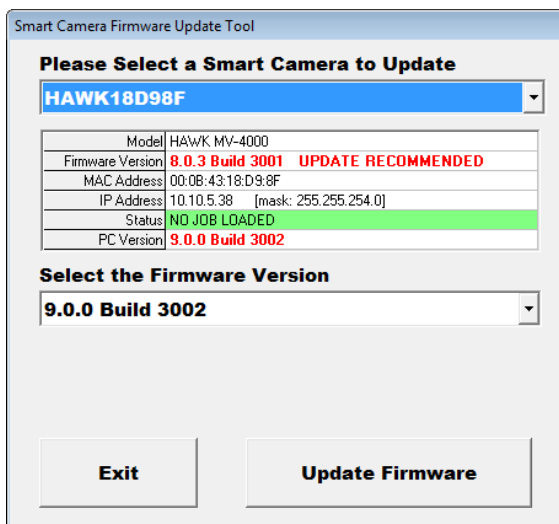

- Select the desired version of firmware from the **Select the Firmware Version** dropdown menu. This menu will list all the firmware versions on your PC.  
**Note:** The firmware versions shown below are representative examples and may not necessarily reflect what you see on the dropdown menu.
- Click the **Update Firmware** button.
- A dialog will appear asking **Are you sure you wish to update this camera?** Click **Yes**.

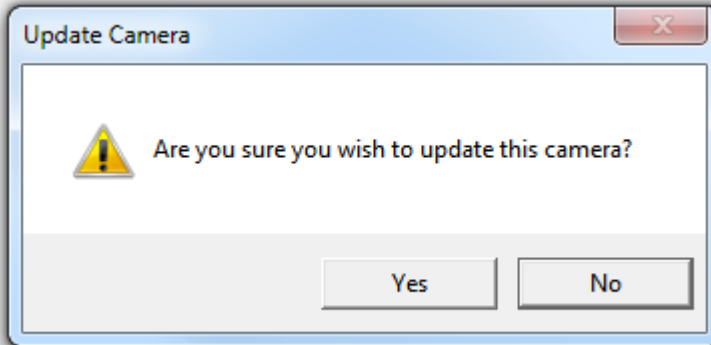

- If a username and password have been defined for the camera, a second dialog will then appear prompting you for your username and password.  
**Important:** The user name and password are both case-sensitive. Click **OK** after you have entered your user name and password to begin the download and install process.

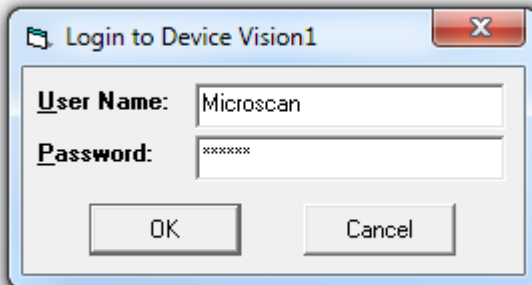

## Updating Firmware

The firmware update process may take more than a minute.

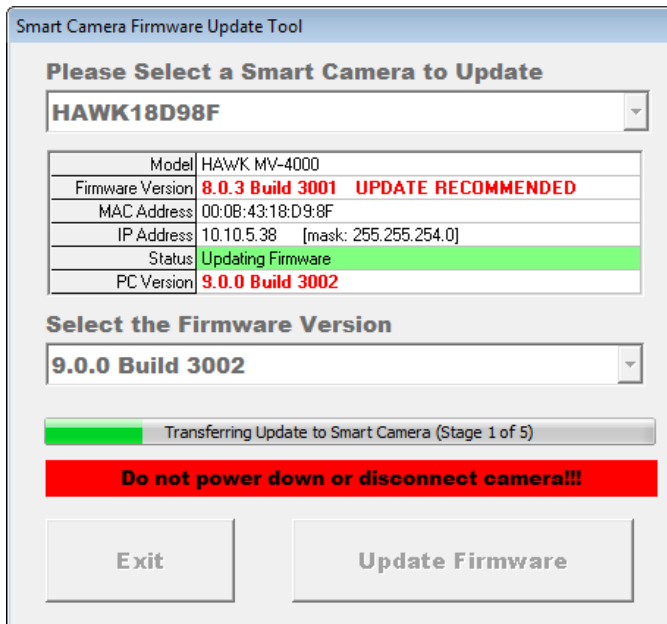

Once the firmware is downloaded and installed, the camera will reboot.

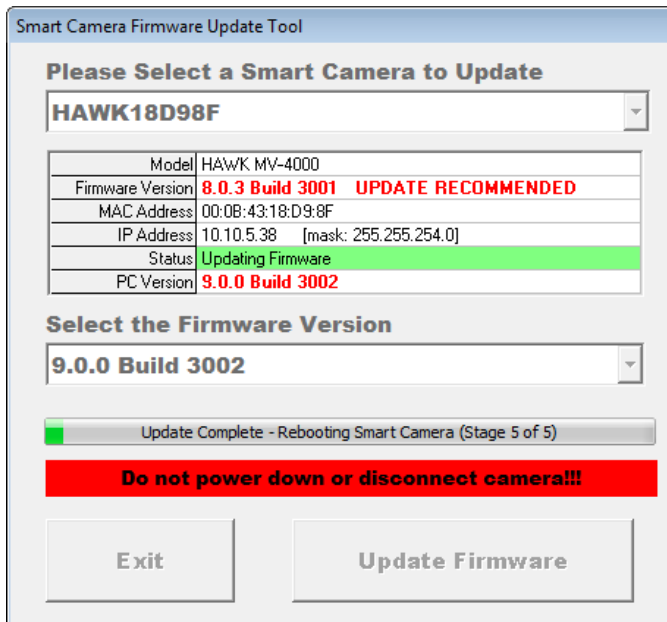

- When the entire firmware update process is complete, click the **Exit** button to close the utility.



**Important:** The camera's firmware version must match the version of Visionscape being used to manipulate a job on the PC.

# Camera License Upgrade

Some advanced AutoVISION features can only be accessed if your camera has the correct license. The following features require a license:

- **Visionscape access** – allows your camera to be accessed from Visionscape FrontRunner or from a custom user interface;
- The **OCV Tool** and **Symbol Quality Verification Tool**.

If you require one of these licenses, you can automatically generate a request by clicking the **License Options** button. You can also right-click on the camera image and select **Upgrade Camera**.

The following dialog will then appear, allowing you to choose an upgrade to **Visionscape** or an upgrade to a **Verification and OCV Tools** license, or allowing you to enter the license key if you already have it. If you select Visionscape or Verification and OCV Tools an ALR file (AutoVISION License Request) is generated. That file must be attached to an e-mail that you can then send to your Omron Microscan Partner. You can also save the ALR file to your PC and then e-mail it to your Partner from a different PC.

The dialog box is titled "You can upgrade this Device to one of the following features:" and contains the following elements:

- Two blue headers: "▼ Select your upgrade feature..." and "▼ Then generate your request here".
- A "Features" section with two checkboxes: "Visionscape" and "Verification and OCV Tools".
- Two buttons: "Email Request Now" and "Create Request File (I'll E-mail it later)".
- A blue prompt: "Already have the license key? Please enter it below".
- A text input field with a dashed line placeholder.
- A button: "Send License to Device".

If you click **E-mail Request Now**, a message similar to the one below will be generated. Send the message to your Omron Microscan Partner to purchase the upgrade.

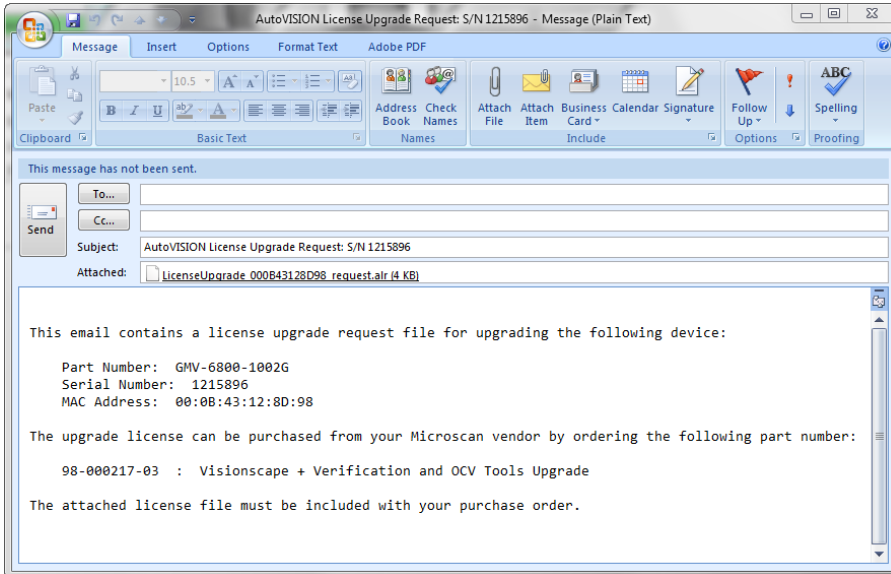

If you click **Create Request File (I'll E-mail It Later)**, the following dialog will appear, providing instructions for how to request the upgrade from your Omron Microscan Partner.

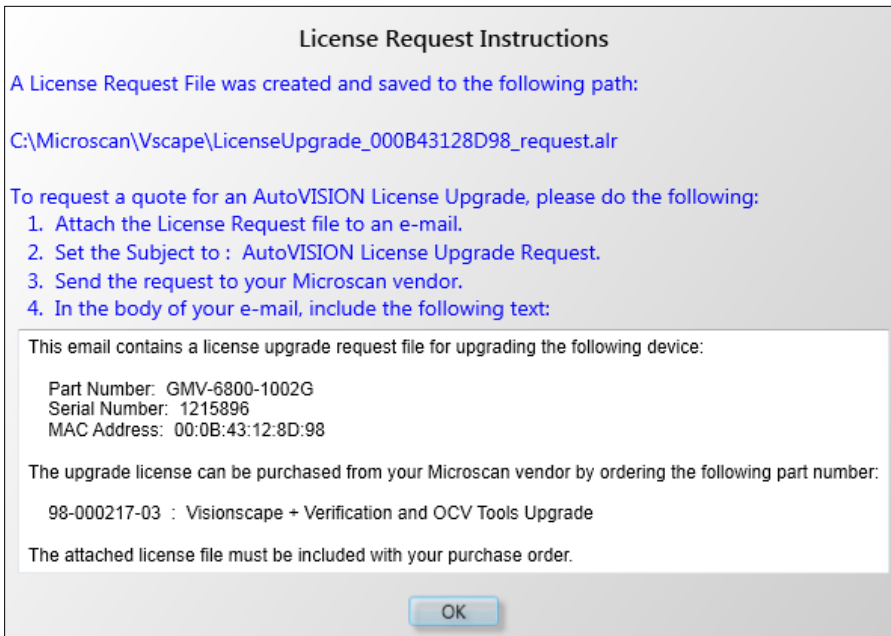

---

## Camera License Upgrade

Once you receive the key from your Omron Microscan Partner, you can enter it in text field shown below to upgrade the camera.

Already have the license key? Please enter it below

Send License to Device

You will receive this error message if the license key is not valid:

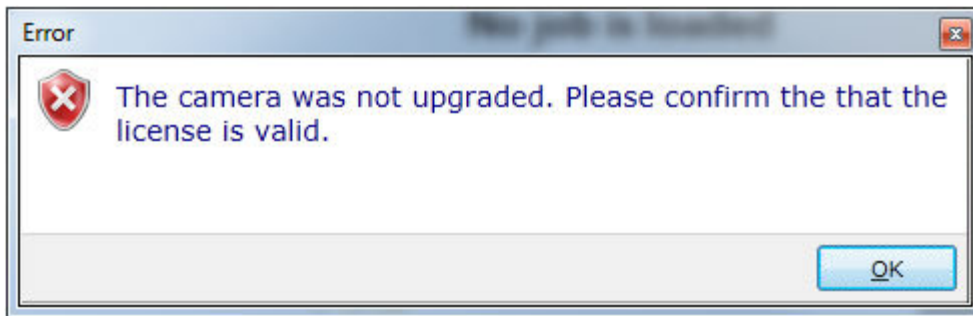

You will receive this message if the license key is valid and the camera is successfully upgraded.

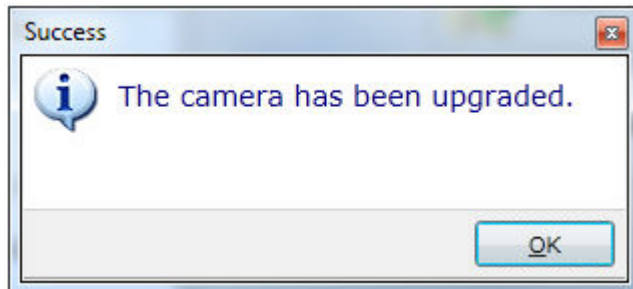



## Licensing the OCV and Symbol Quality Verification Tools

The **OCV Tool** and **Symbol Quality Verification Tool** can be used in the Emulator, but for use with a camera, both tools require a license. The license can be purchased using the **Upgrade License** feature.

When you try to download a job with unlicensed tools to the camera, the **Unlicensed Tools** dialog will appear:

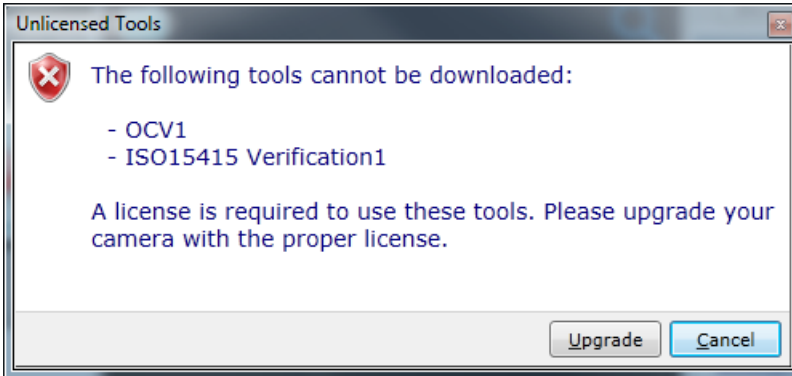

If you click **Cancel**, the job will still be editable and can be saved to your PC, but not downloaded to the camera.

If you click **Upgrade**, the following upgrade dialog will appear. This dialog allows you to select which upgrades to purchase, to create and e-mail an upgrade request to your Omron Microscan Partner, and to enter the license key if you already have it.

**Note:** The **Verification and OCV Tools** license must be purchased in order to download those tools.

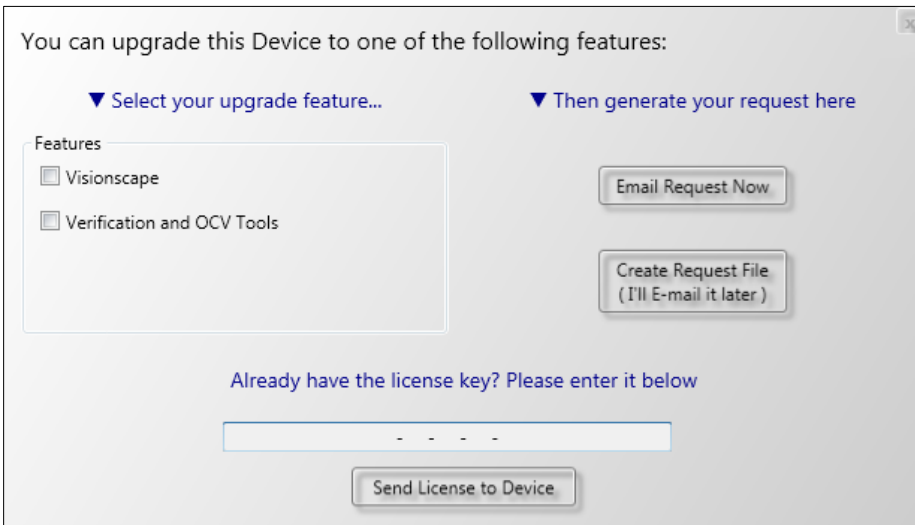



# 7 Example Job: Gasket Inspection

## Contents

Start Gasket Job .....	7-2
Add Measure Tool .....	7-3
Add Three Presence/Absence Tools .....	7-4
Report Gasket Inspection Status and Gasket Height .....	7-5
Run the Gasket Job .....	7-6

This example machine vision job demonstrates **AutoVISION**'s tools and output capabilities in action.

The purpose of this job is to verify the following elements of an automotive gasket:

- **Cut size**
- **Presence of bolt holes**
- **Correct size of center hole**

and then to report the inspection status and gasket height.

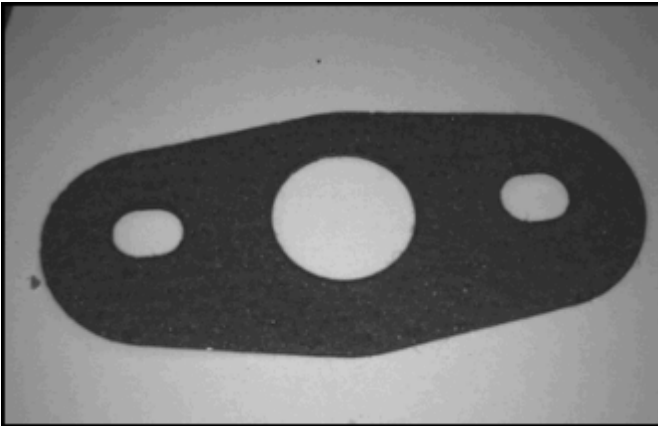

# Start Gasket Job

- Select the Emulator from the **Select Device** menu in the **Connect** view.
- Create a new job and proceed to the **Edit** view.

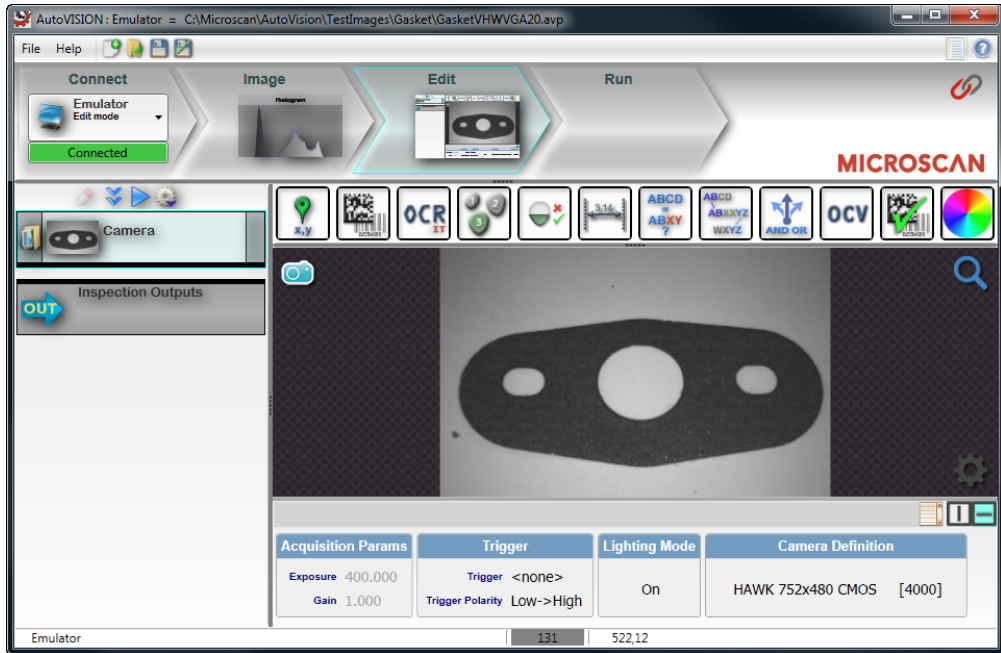

- Select the directory in which the image you want to inspect is stored (in this example, an image of an automotive gasket). Click the folder icon to the left of the **Camera** tool. This will bring up the **Browse For Folder** dialog. Click on the folder containing the images you want to inspect, and then click **OK**.

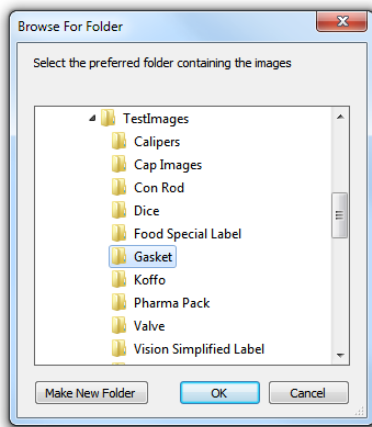

# Add Measure Tool

Add a **Measure Tool** to check the height of the gasket.



Set the following Measure Tool parameters:

- **Function:** Height Measurement, Light Background to Dark Object.
- **Edge Quality:** A Little Rough, Not Always Straight.
- Set tolerances to accept good cuts but reject bad cuts.

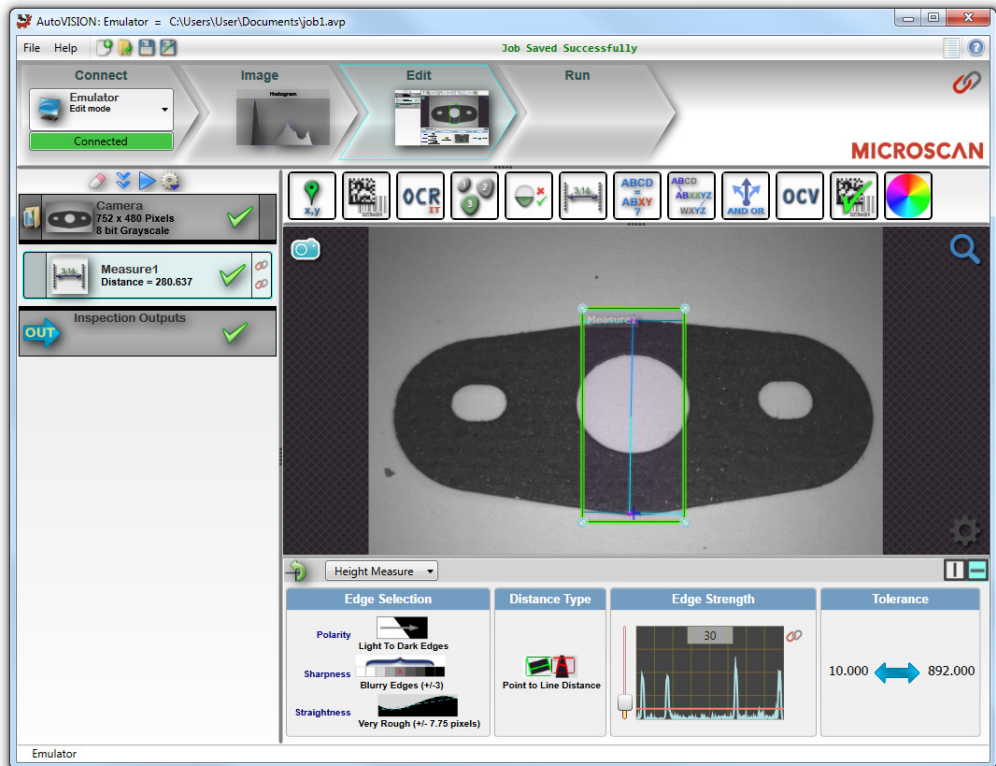

**Hint:** Double-click on the name of the tool (**Measure1**) in the tool list on the left side of the interface to re-name the tool.

## Add Three Presence/Absence Tools

Add two **Presence/Absence Tools**: one for each of the gasket's two smaller holes.



Set the following Presence/Absence Tool parameters:

- Adjust Threshold to look for light pixels.
- Adjust Limits so the tool fails when no hole is present.

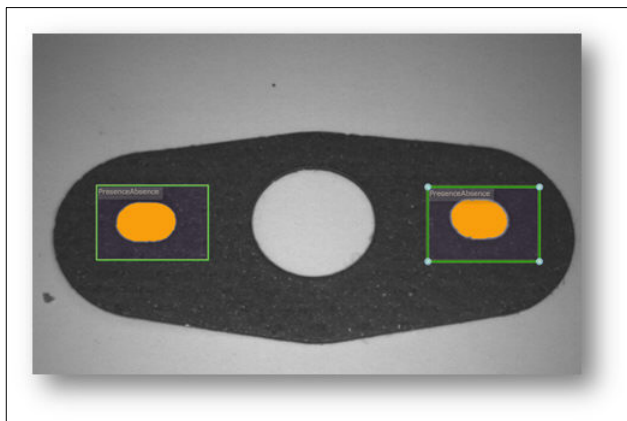

Add a third Presence/Absence Tool to measure the size of the gasket's center hole.

- Adjust Threshold to look for light pixels.
- Adjust Limits so the tool fails when the hole is too small.

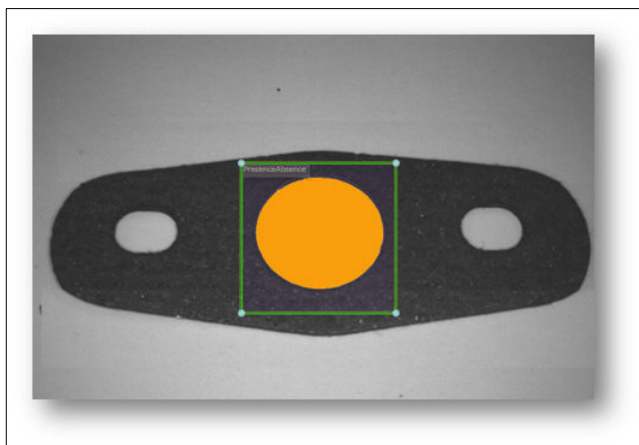

# Report Gasket Inspection Status and Gasket Height

Click on **Inspection Outputs** in the job list to report inspection status and gasket height. Set the following output parameters:

- Use **TCP/Serial Output** for Emulator testing.
- Add formatting around inspection status and measurement value.

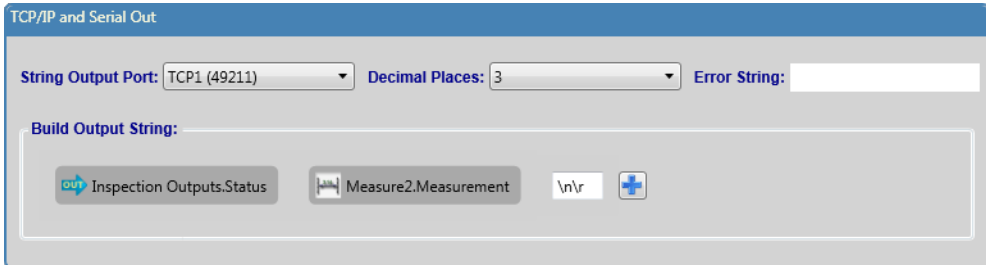

- Telnet to 127.0.0.1 to check the data format.

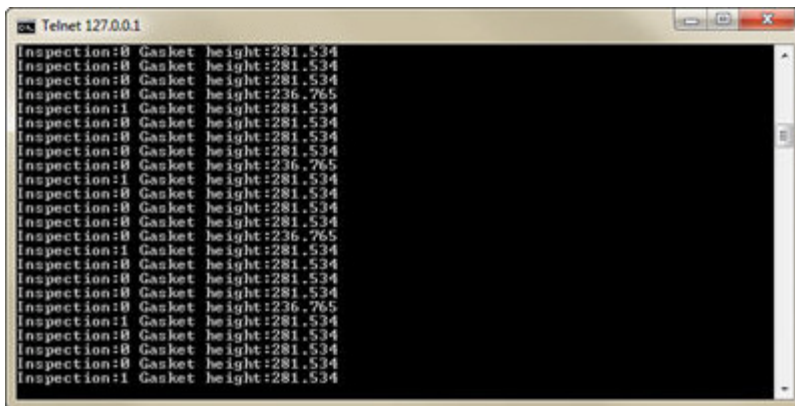

**Note:** See [TCP/Serial Output](#) for a description of how to use Telnet to view TCP output.

# Run the Gasket Job

Click on the **Run** section of the Navigator Bar to begin the job. The Run view allows you to watch the total number of inspections that pass and fail, as well as other data such as **Cycles**, **PPM** (Parts Per Minute), **Buffers**, and **Overruns**.

