

MICROSCAN.

MS-2 CCD Reader User Manual



Copyright and Disclaimer

Copyright ©2015
Microscan Systems, Inc.
Tel: +1.425.226.5700 / 800.762.1149
Fax: +1.425.226.8250

All rights reserved. The information contained herein is proprietary and is provided solely for the purpose of allowing customers to operate and/or service Microscan manufactured equipment and is not to be released, reproduced, or used for any other purpose without written permission of Microscan.

Throughout this manual, trademarked names might be used. We state herein that we are using the names to the benefit of the trademark owner, with no intention of infringement.

Disclaimer

The information and specifications described in this manual are subject to change without notice.

Latest Manual Version

For the latest version of this manual, see the Download Center on our web site at:
www.microscan.com.

Technical Support

For technical support, e-mail: helpdesk@microscan.com.

Warranty

For current warranty information, see: www.microscan.com/warranty.

Microscan Systems, Inc.

United States Corporate Headquarters

+1.425.226.5700 / 800.762.1149

United States Northeast Technology Center

+1.603.598.8400 / 800.468.9503

European Headquarters

+31.172.423360

Asia Pacific Headquarters

+65.6846.1214

Table of Contents

Chapter 1	Quick Start	
	Step 1 Check Hardware	1-2
	Step 2 Connect the System	1-3
	Step 3 Install ESP	1-4
	Step 4 Select Model	1-5
	Step 5 Connect	1-6
	Step 6 Position the Reader	1-7
	Step 7 Configure the Reader	1-8
	Step 8 Save Configuration in ESP	1-9
Chapter 2	Using ESP	
	EZ Mode	2-2
	Application Mode	2-3
	Menu Toolbar	2-4
	Autoconnect	2-12
	View	2-14
	Navigating in ESP	2-15
	Send/Receive Options	2-16
Chapter 3	Communications	
	Communications by ESP	3-2
	Communications Serial Commands	3-3
	Host Port Connections	3-4
	Host Port Protocol	3-5
	Preamble	3-6
	Postamble	3-7
	Keyboard Mapping	3-8
	USB Keyboard Key Codes	3-9
Chapter 4	Read Cycle	
	Read Cycle by ESP	4-2
	Read Cycle Serial Commands	4-3
	MS-2 Read Cycle Overview	4-4
	Number of Symbols	4-5
	Time Between Identical Decodes	4-6
	Trigger Mode	4-7
	Continuous Read 1 Output Emulation	4-9
	Serial Trigger Character (Delimited)	4-10
	Start Trigger Character (Non-Delimited)	4-11
	Stop Trigger Character (Non-Delimited)	4-12
	No Decode Timeout	4-13
	Decodes Before Output	4-14
	No Read Message	4-15
	Reader Setup	4-16

Table of Contents

Beeper	4-17
Chapter 5 Symbologies	
Symbologies by ESP	5-2
Symbologies Serial Commands	5-3
Code 39	5-4
Codabar	5-6
Interleaved 2 of 5	5-8
Code 128/EAN-128	5-10
Code 93	5-11
GS1 DataBar (RSS)	5-12
MSI Code	5-13
Plessey Code	5-14
Industrial 2 of 5	5-15
UPC/EAN	5-17
Symbology Identifier	5-20
Chapter 6 Terminal	
Terminal Window	6-2
Find	6-3
Send	6-4
Macros	6-5
Terminal Window Menus	6-6
Chapter 7 Utilities	
Serial Utility Commands	7-2
Differences from Default	7-3
Firmware	7-4
Device Control	7-7
Default/Reset/Save	7-8
Reader Status Request	7-9
Appendices	
Appendix A General Specifications	A-2
Appendix B Electrical Specifications	A-5
Appendix C Serial Configuration Commands	A-6
Appendix D Communications Protocol	A-10
Appendix E ASCII Table	A-11
Appendix F Operational Tips	A-12
Appendix G Using an External Trigger	A-13
Appendix H Glossary of Terms	A-14

About the MS-2 CCD Reader

The key features of the MS-2 CCD Reader are:

- Ultra-compact size
- CCD image sensor
- LED illumination
- Programmable beeper
- No moving parts
- Low power draw (voltage: 5V; current: 150 mA)
- ESP and K command support
- Up to 530 scans per second
- Up to 55 decodes per second
- High Density and Low Density options
- LED status indicators
- IP54-rated enclosure
- RS-232 or USB 1.1 (Keyboard Mode only) connectivity (Virtual COM serial emulation not supported)
- 32-bit processor
- Corner cable exit for easy mounting

About This Manual

This manual provides complete information on setting up, installing, and configuring the MS-2 CCD Reader. The sections are presented in the order in which a reader might be set up and made ready for operation.

Highlighting

Serial commands, highlighted command fields, and default command settings are highlighted in **rust bold**. Cross-references and web links are highlighted in **blue bold**. References to **ESP**, its toolbar headings (**Communications**, **Read Cycle**, **Symbologies**, etc.), menu topics, and other points of emphasis, are highlighted in **Bold Initial Caps**.

Host Communications

There are two ways to configure and test the MS-2 CCD Reader:

- Microscan's Windows-based **ESP** (Easy Setup Program) Software, which offers point-and-click ease of use and visual responses to user adjustments.
- Serial commands, such as **<K200,0>**, that can be sent from **ESP's Terminal** or another terminal program.

Warning and Caution Summary

WARNING

LED LIGHT

DO NOT VIEW DIRECTLY WITH OPTICAL INSTRUMENTS

CLASS 1 LED PRODUCT WITH CLASS 1 INTERNAL RADIATION

Maximum LED Output: 141.2 μ W

IEC 60825-1:1993+A1:1997+A2:2001

- Viewing the MS-2's LED output with optical instruments such as magnifiers, eye loupes, or microscopes within a distance of 100 mm could cause serious eye injury.
- Maximum LED output: 141.2 μ W
- Location of the MS-2's LED aperture window:



LED Aperture Window

CAUTION: Use of controls or adjustments or performance of procedures other than those specified herein may result in hazardous radiation exposure.

IMPORTANT: The MS-2 is intended for connection to a UL-listed direct plug-in power unit marked Class II and rated 5 VDC at 3.5 Watts, or greater if using electrical accessories. European models must use a similarly rated Class I or Class II power supply that is certified to comply with safety standard EN 60950.

Statement of Agency Compliance



The MS-2 has been tested for compliance with FCC (Federal Communications Commission) regulations and has been found to conform to all applicable FCC Rules and Regulations.

To comply with FCC RF exposure compliance requirements, this device must not be co-located or operate in conjunction with any other antenna or transmitter.

Changes or modifications not expressly approved by the party responsible for compliance could void the user's authority to operate the equipment.



The MS-2 has been tested for compliance with CE (Conformité Européenne) standards and guidelines, and has been found to conform to applicable CE standards, specifically the EMC requirements EN 55024:1998+A1:2001+A2:2003, ESD EN 61000-4-2, Radiated RF Immunity EN 61000-4-3, ENV 50204, EFT EN 61000-4-4, Conducted RF Immunity EN 61000-4-6, EN 55022:1998+A1:2000+A2:2003 for Class A products, Class B Radiated Emissions, and Class B Conducted Emissions.

The MS-2 has been tested by an independent electromagnetic compatibility laboratory in accordance with the applicable specifications and instructions.

Statement of RoHS Compliance

All Microscan readers with a 'G' suffix in the FIS number are RoHS-Compliant. All compliant readers were converted prior to March 1, 2007. All standard accessories in the Microscan Product Pricing Catalog are RoHS-Compliant except 20-500013-01 and 98-000039-02. These products meet all the requirements of "Directive 2002/95/EC" European Parliament and the Council of the European Union for RoHS compliance. In accordance with the latest requirements, our RoHS-Compliant products and packaging do not contain intentionally added Deca-BDE, Perfluorooctanes (PFOS) or Perfluorooctanic Acid (PFOA) compounds above the maximum trace levels. To view the document stating these requirements, please visit:

<http://eur-lex.europa.eu/LexUriServ/LexUriServ.do?uri=CELEX:32002L0095:EN:HTML>

and

<http://eur-lex.europa.eu/LexUriServ/LexUriServ.do?uri=OJ:L:2006:372:0032:0034:EN:PDF>

Please contact your sales manager for a complete list of Microscan's RoHS-Compliant products.

This declaration is based upon information obtained from sources which Microscan believes to be reliable, and from random sample testing; however, the information is provided without any representation of warranty, expressed or implied, regarding accuracy or correctness. Microscan does not specifically run any analysis on our raw materials or end product to measure for these substances.

The information provided in this certification notice is correct to the best of Microscan's knowledge at the date of publication. This notice is not to be considered a warranty or quality specification. Users are responsible for determining the applicability of any RoHS legislation or regulations based on their individual use of the product. In regards to "RoHS Directive 2011_65_EU" Microscan produces Monitoring and Control Instruments as well as Industrial Monitoring & Control Instruments as defined within the directive. Microscan has developed and is implementing a RoHS2 compliance plan with the intention of bringing all active products listed in our current marketing literature within full compliance as per the directive deadlines.

Key milestones for the transition plan are as follows:

- Complete internal product audit by July 2014.
- Initial "Monitoring and Control Instruments" RoHS2 compliant products available by December 2014
- Initial "Industrial Monitoring & Control Instruments" RoHS2 compliant products available by July 2015
- All new products introduced in 2015 are expected to be WEEE & RoHS2 compliant.

Microscan will mark the products with the 'CE' marking that complies with the RoHS2 process to acquire 'CE' certification per the example given: Example >> Machinery directive + EMC directive + RoHS2 = Declaration of Conformity.



1 Quick Start

Contents

Step 1 Check Hardware.....	1-2
Step 2 Connect the System	1-3
Step 3 Install ESP	1-4
Step 4 Select Model.....	1-5
Step 5 Connect.....	1-6
Step 6 Position the Reader	1-7
Step 7 Configure the Reader	1-8
Step 8 Save Configuration in ESP.....	1-9

This section is designed to get your MS-2 CCD Reader up and running quickly using **ESP** (Easy Setup Program). Following these steps will allow you to get a sense of the reader's capabilities and to test symbol decode performance.

Detailed setup information for installing the reader into your application can be found in the subsequent sections.

Step 1 — Check Hardware

Caution: Be sure that all cables are connected **BEFORE** applying power to the system. Always power down **BEFORE** disconnecting any cables.

USB Hardware

Item	Description	Part Number
1	MS-2 CCD Reader	FIS-0002-000XG

Important: USB models support USB 1.1 Keyboard Mode only. Virtual COM serial emulation is not supported.

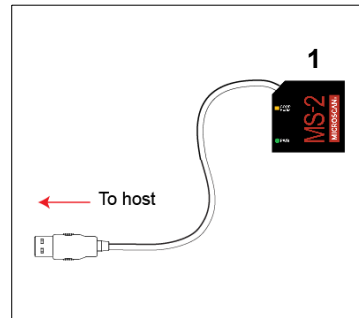

USB Hardware Required

RS-232 Hardware

Item	Description	Part Number
1	MS-2 CCD Reader	FIS-0002-000XG
2	IC-332 Adapter	FIS-0001-0035G
3	IB-131 Interface Box	99-000018-01
4	Power Supply (90-264 VAC, 24VDC, USA/Euro plug)	97-000012-02
5	Object Detector	99-000017-01
6	Communication Cable	61-300026-03

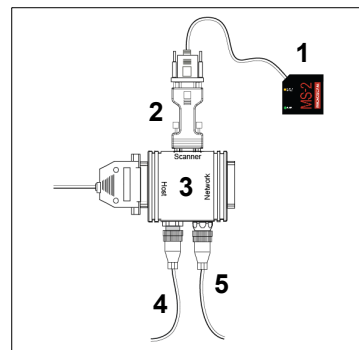

RS-232 Hardware Required

Step 2 — Connect the System

Caution: Be sure that all cables are connected **BEFORE** applying power to the system. Always power down **BEFORE** disconnecting any cables.

Connecting by USB

- Connect the reader (1) to the host computer.
The reader is powered by the USB connection.

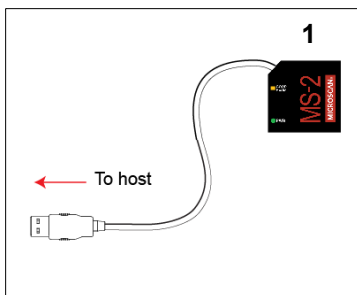

USB Hardware Configuration

Important: USB models support USB 1.1 Keyboard Mode only. Virtual COM serial emulation is not supported.

Connecting by RS-232

- Connect the reader (1) to the IB-131/IC-332 interface (2) and (3).
- Connect the host cable (6) to the host and to the host port on the IB-131 (3).
- Connect the object detector (5) to the IB-131 (3).
- Connect the power supply (4) to the IB-131 (3).
- Apply power to the reader.

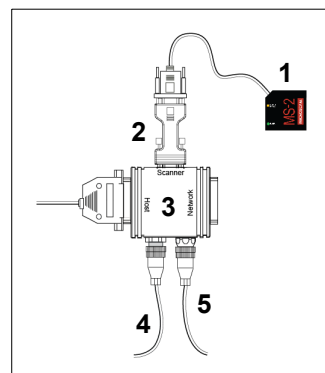

RS-232 Hardware Configuration

Step 3 — Install ESP

ESP Software can be found on the Microscan Tools Drive that is packaged with the MS-2.

1. Follow the prompts to install ESP from the Tools Drive.
2. Click on the ESP icon to run the program.



Note: ESP can also be installed from the **Download Center** at www.microscan.com.

Minimum System Requirements

- 233 MHz Pentium PC
- Windows 8, 7, Vista, or XP operating system (32-bit or 64-bit)
- Internet Explorer 6.0 or higher
- 128 MB RAM or greater
- 160 MB free disk space
- 800 x 600 256 color display (1024 x 768 32-bit color recommended)

Step 4 — Select Model

When you start **ESP**, the following menu will appear:

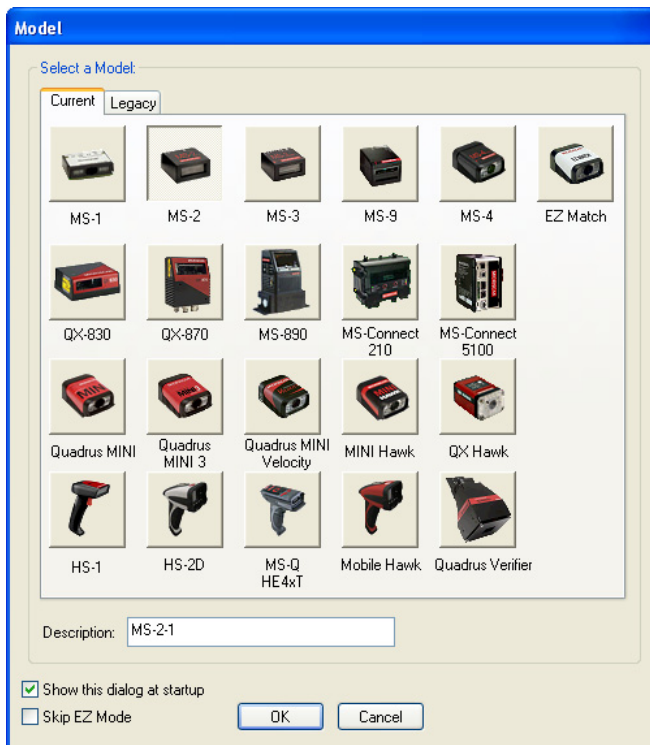

1. Click the button showing the MS-2.
2. Click **OK**.

Note: You can also double-click the MS-2 button to make your selection.

3. Click **Yes** when this dialog appears:

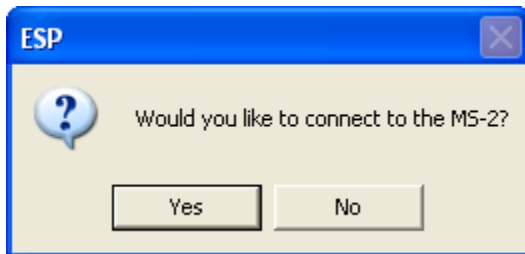

Note: If you need to select another model later, click the **Switch Model** button near the top of the screen or use **Model > New Model** in the menu toolbar.

Step 5 — Connect

- Choose the connection protocol you are using and click **Connect**.

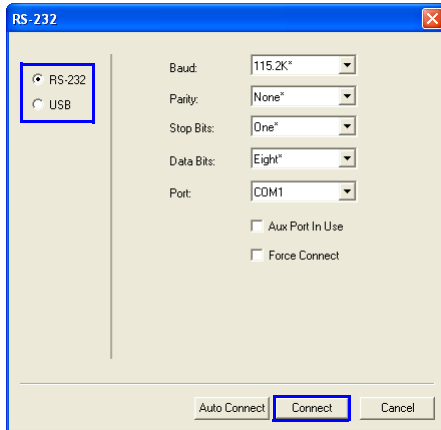

- Once you select your communications mode, follow the simple prompts to establish your connection.

When you are connected, you will see the green connection indicator in the status bar at the bottom right of your screen.

RS-232: CONNECTED Point-to-Point COM1

USB: CONNECTED USB

- If your RS-232 connection attempt fails, click the **Autoconnect** button, select a different communications port, and try again.

Note: If your RS-232 host settings cannot be changed to match the imager’s settings, check the **Force Connect** box in the **RS-232** dialog and click the **Connect**.

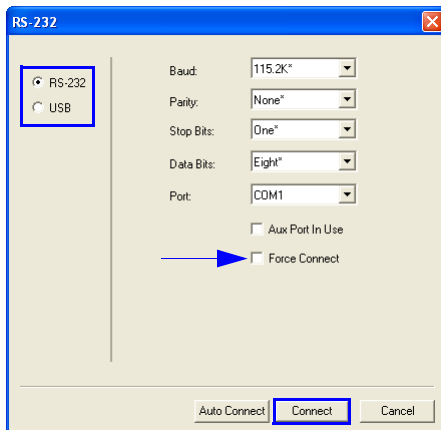

Step 6 — Position the Reader

- Set up a symbol at the distance you will be using in your application. Refer to the [Read Ranges](#) for your MS-2 model (High Density or Low Density) to determine the optimal distance.
- **Note:** If you are using an Interleaved 2 of 5 symbol, verify that the number of characters being scanned matches the symbol length enabled for I 2/5 (default is **10** and **6**).
- Avoid bright light or infrared light from other sources, including other readers.
- Pitch the reader or symbol at a minimum of $\pm 15^\circ$ to avoid specular reflection (the return of direct, non-diffused light).
- Avoid excessive skew or pitch. Maximum skew is $\pm 30^\circ$; maximum pitch is $\pm 30^\circ$.

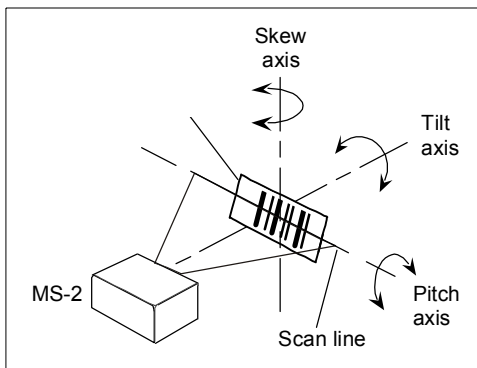

Reader and Symbol Orientation

Note: Code 39 is the default symbology enabled. If you are uncertain of your symbology, perform the following steps:

1. Enable all symbologies using **ESP**.
2. Enable **Symbology Identifier** at the bottom of ESP's **Symbologies** tree control.

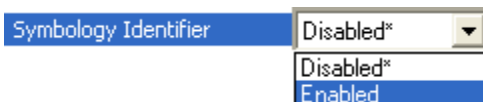

3. Decode the symbol and compare the symbology identifier character to the list on page [5-22](#) to determine your symbology.
4. Disable all other symbologies.

Step 7 — Configure the Reader

To make setup changes to the reader, click the **App Mode** button.



The following modes are accessible by clicking the buttons in the first row of **App Mode** icons:



- Click the **Autoconnect** button to establish communications between **ESP** and the reader.
- Click the **Send/Recv** button to send or receive commands.
- Click the **Parameters** button to show the tree controls for Communication, Read Cycle, and Symbologies.
- Click the **Terminal** button to display decoded symbol data and to send serial commands to the reader using text or macros.
- Click the **Utilities** button to test Read Rate, request or clear Counters, enable or disable the reader or send output pulses in Device Control, determine the Differences from Default in the current settings, add or remove master symbol data in Master Database, and verify or update the reader's Firmware.

Step 8 — Save Configuration in ESP

To make changes to a configuration setting:

The screenshot shows a configuration window with two panes: 'Parameters' and 'ESP Values'. The 'Parameters' pane is expanded to show a tree view of settings. The 'Postamble' setting is selected and highlighted in blue. The 'ESP Values' pane shows the selected 'Postamble' setting with a dropdown menu open, displaying 'Enabled*' as the current selection and 'Disabled' as an alternative option. A callout box points to the dropdown menu with the instruction: '3. Place your cursor in the selection box, scroll down to the setting you want to change, and click once on the setting.'

1. **Left-click** on the **+** to expand the desired tree.
2. **Double-click** on the desired parameter and click once in the selection box to view options.
3. Place your cursor in the selection box, scroll down to the setting you want to change, and **click** once on the setting.
4. **Left-click** again on the open screen to complete your selection.
5. **Right-click** on the open screen and select **Save to Reader** to implement the command in the reader.

Saving Options

- **Send, No Save.** Changes will be lost when power is re-applied to the reader.
- **Send and Save.** This activates all changes in current memory *and* saves to the reader for power-on.

Save Configuration in ESP

2 Using ESP

Contents

EZ Mode.....	2-2
Application Mode.....	2-3
Menu Toolbar.....	2-4
Autoconnect.....	2-12
View.....	2-14
Navigating in ESP.....	2-15
Send/Receive Options.....	2-16

This section is designed to help you understand the basic structure and elements of **ESP** (Easy Setup Program).

When you open **ESP**, unless otherwise specified in the **ESP Preferences** dialog accessible from the **Options** heading on the menu toolbar, you will enter **EZ Mode** for initial setup. From there, you can enter **Application Mode (App Mode)** and access three configuration menus (**Communications**, **Read Cycle**, and **Symbologies**), a **Terminal** interface, and a **Utilities** interface.

ESP can be used to configure the MS-2 CCD Reader in three main ways:

- **Tree Controls:** Each configuration menu contains a list of all option settings that pertain to that specific element of reader operation. For example, the **Communications** menu shows a **Host Port Connections** option, and then a list of the sub-options **Baud Rate**, **Parity**, **Stop Bits**, and **Data Bits**. Each of these sub-options is configurable by using dropdown menus.
- **Graphic User Interfaces:** Reader settings can be configured using such point-and-click tools as radio buttons, zoom in/zoom out sliders, spin boxes, check boxes, and drag-and-drop functions.
- **Terminal:** **ESP's Terminal** allows you to send serial configuration and utility commands directly to the reader by typing them in the provided text field.

Information about using **ESP** in specific applications is provided in subsequent sections.

For **ESP** system requirements, see [Minimum System Requirements](#) in [Quick Start](#).

EZ Mode

EZ Mode offers instructions on positioning the reader in relation to a test symbol, and also features an **Autodiscriminate** function that automatically enables all symbologies.

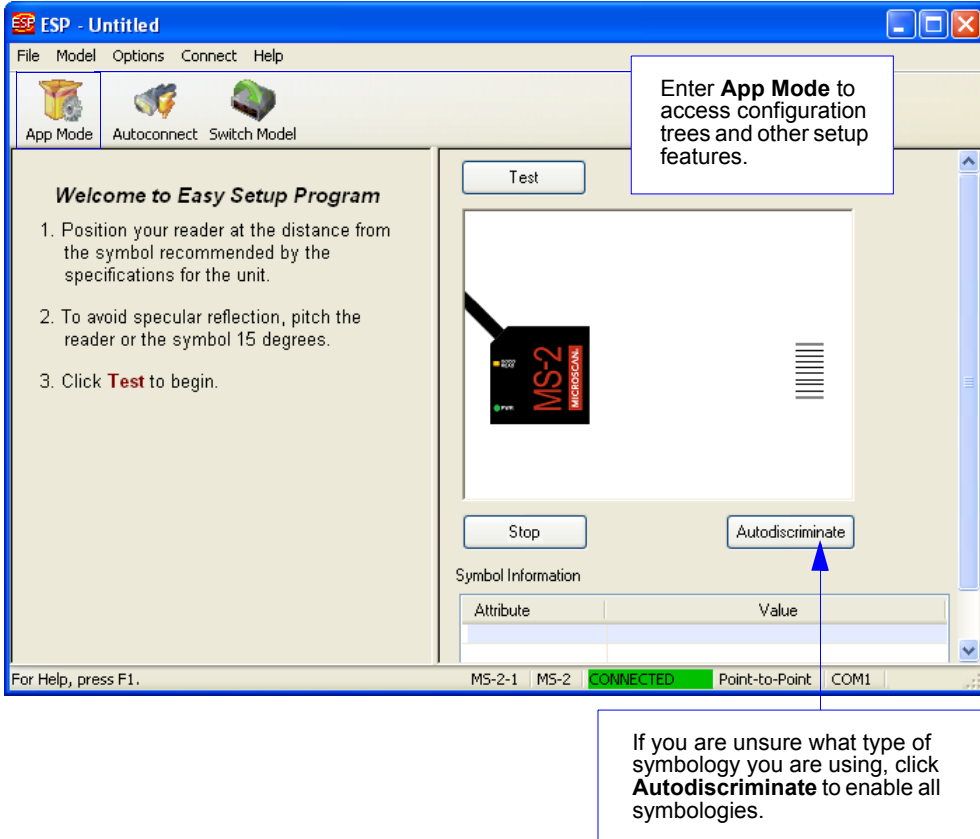

Application Mode

From **EZ Mode**, you can click on the **App Mode** button to access specific configuration menus, **Utilities** tools, **Camera** setup, **Output Format** options, and a **Terminal** window where serial commands can be entered.

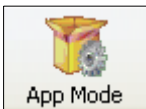

Note: The **App Mode** and **EZ Mode** buttons appear in the same position to allow easy switching between these primary modes.

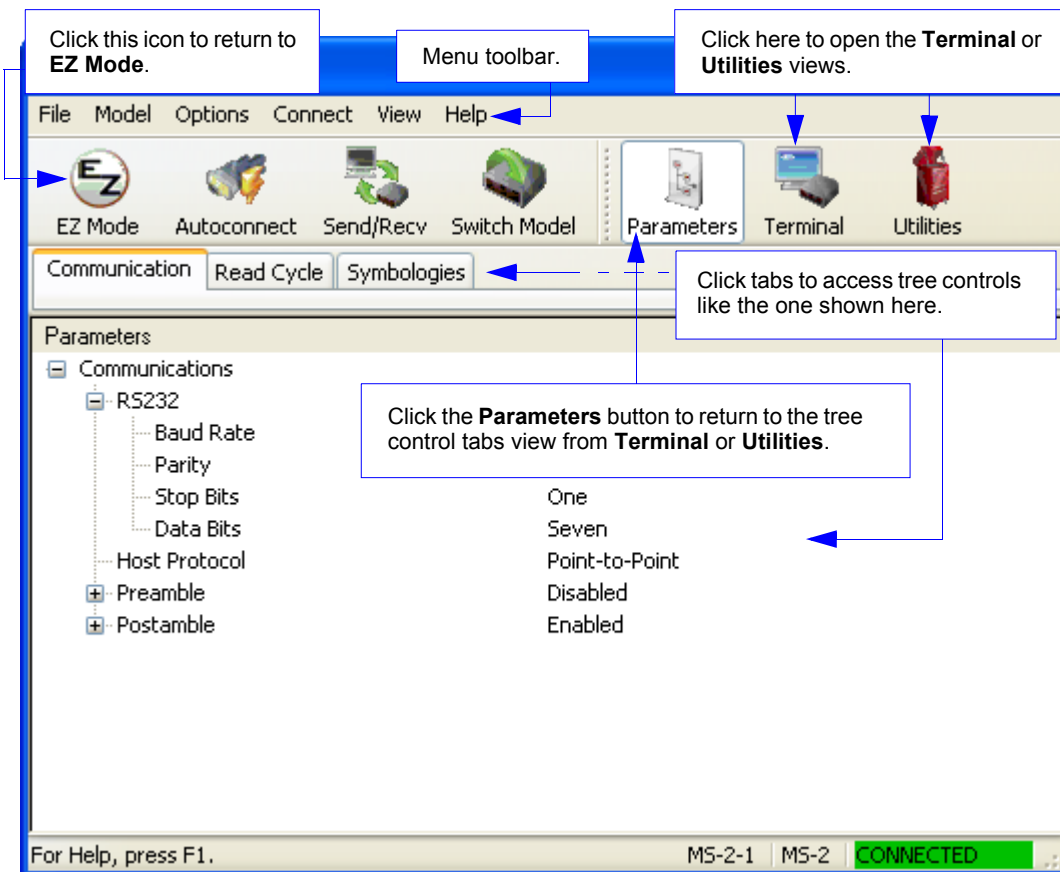

Note: See the corresponding sections in this manual for specific information on any of the views or modes mentioned above.

Menu Toolbar

File > New

Whenever **New** is selected, the default configuration of **ESP** is loaded.

Open/Save

When **Save** or **Save As** is selected, the **ESP** configuration is saved to the host computer's hard drive and available whenever the same file is selected under **Open**.

Important: When you save menu changes to your hard drive, these changes are not saved to your reader. The illustration below shows how settings can be saved and received between **ESP** and the reader, and **ESP** and the host hard drive.

File	
New	Ctrl+N
Open...	Ctrl+O
Save	Ctrl+S
Save As...	
Print...	Ctrl+P
Import...	
Export...	
Recent File	
Exit	

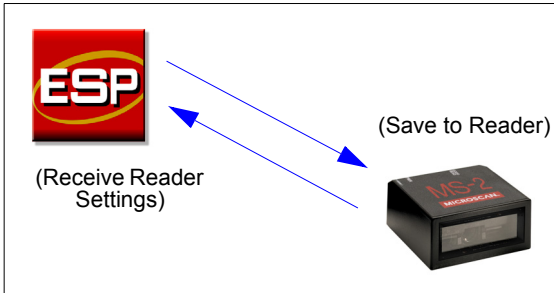

Import/Export

Import converts the ASCII settings from a text file to **ESP** configuration settings.

Export converts the active **ESP** configuration settings to an ASCII text file.

Model

In the **Model** menu you can select any of the models supported by **ESP**. When you choose a different model, the connection to your present model will be terminated.

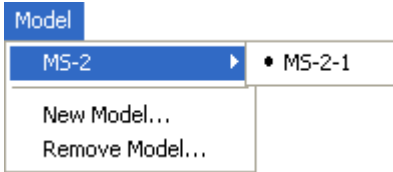

To connect to another model, select **New Model**, choose a new model from the pop-up menu that appears, and click **OK**.

Note: When you save an **ESP** file, you are saving the settings of all the models defined in that file.

Options

The **Options** menu allows you to save memos and set up **ESP Preferences**.

Note: Preferences will be saved and loaded into **ESP** whenever **ESP** is opened next, whether or not you save the **ESP** file.

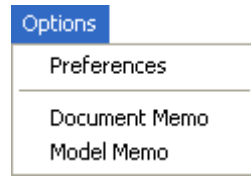

Preferences > General Tab

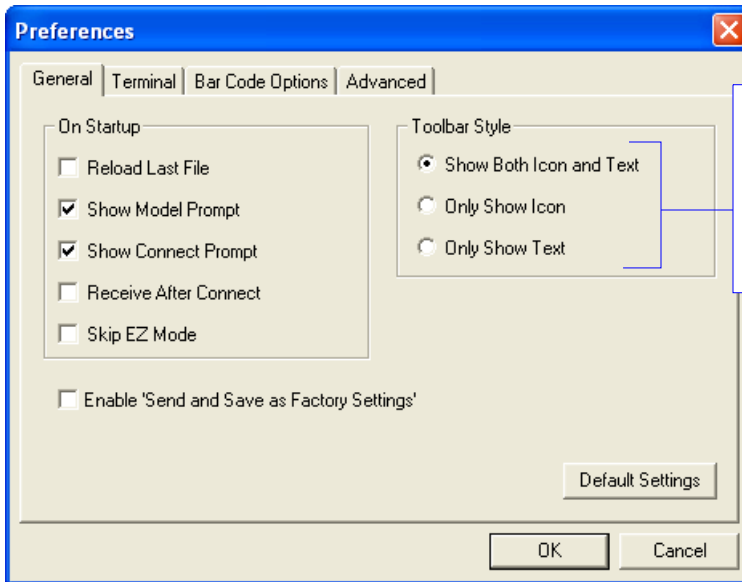

The **Toolbar Style** options allow you to determine how **ESP** will display the mode options in the two rows at the top of the screen.

Reload Last File

At startup, reloads the last file saved to the host computer's hard drive.

Show Model Prompt

At startup, shows the model menu displaying all supported readers.

Show Connect Prompt

At startup, displays the **Would you like to connect to the MS-2?** prompt.

Receive After Connect

At startup, loads the reader's settings into **ESP**. (This is not recommended if you want to preserve your **ESP** settings for future use.)

Skip EZ Mode

At startup, skips **EZ Mode** and opens directly in **App Mode**.

Preferences > Terminal Tab

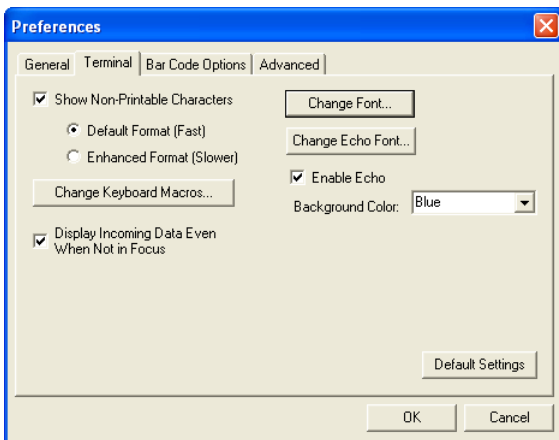

Show Non-Printable Characters

When **Show Non-Printable Characters** is enabled, characters such as “CRLF” will be displayed in the Terminal window. When **Enhanced Format** is checked, the characters are displayed with more detailed formatting.

Change Keyboard Macros

Clicking the **Change Keyboard Macros** button brings up the **Function Keys** dialog. In this dialog you can select the desired function key and then enter your macro keystrokes in the associated key map. For example, to make **Ctrl-F2** the keystroke to send a trigger character, select **F2**, then in the **Ctrl** row, enter **<trigger character>** and click **OK**. Then whenever the **Ctrl-F2** keystroke is pressed, the trigger character will start the read cycle.

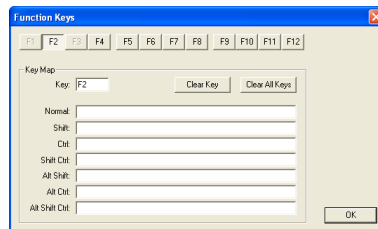

Note: The **F1** key is reserved for opening **ESP Help** and the **F3** key is reserved for the **Find Next** function.

Change Font

Allows you to modify the font used for decode data received from the reader on the Terminal screen.

Change Echo Font

Allows you to modify the font used for command characters typed into the Terminal view.

Enable Echo

Allows you to enter command characters in Terminal.

Display Incoming Data Even When Not in Focus

When **Display Incoming Data Even When Not in Focus** is enabled, data from the reader will continue to appear in the Terminal even when **ESP** is not the top window.

Preferences > Bar Code Options Tab

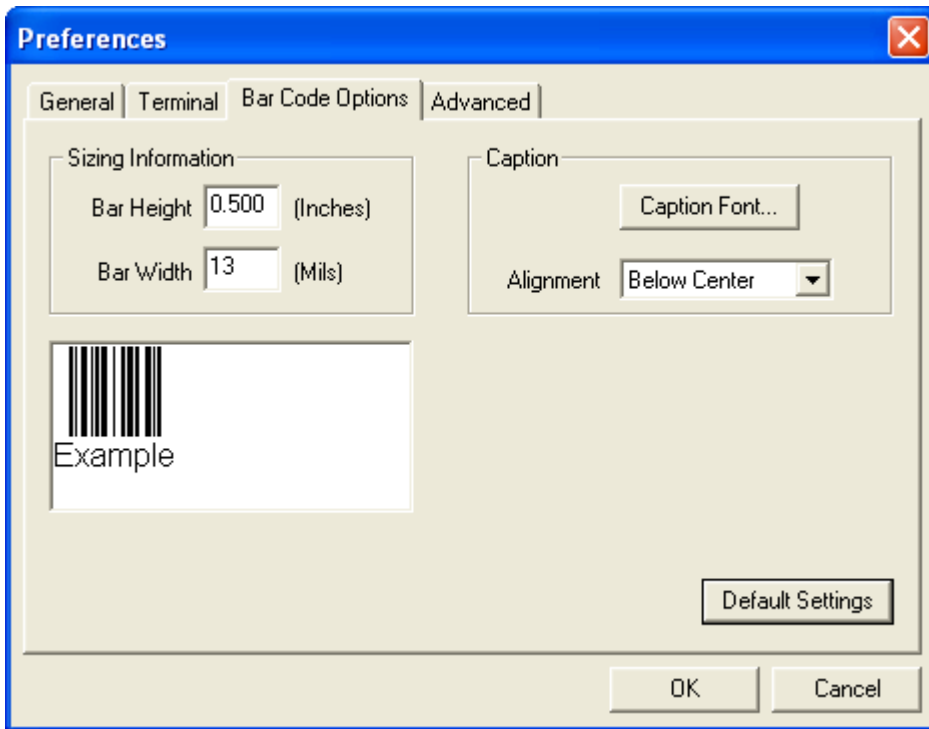

The **Bar Code Options** dialog allows you to set the size of user-created symbols.

Sizing Information

Sets the bar width or module width (in **mils**, or thousandths of an inch) of user-created symbols.

Example: A bar width of 14 is 0.014 inches.

Caption

Allows you to define and position a human-readable caption for the symbol you create.

Preferences > Advanced Tab

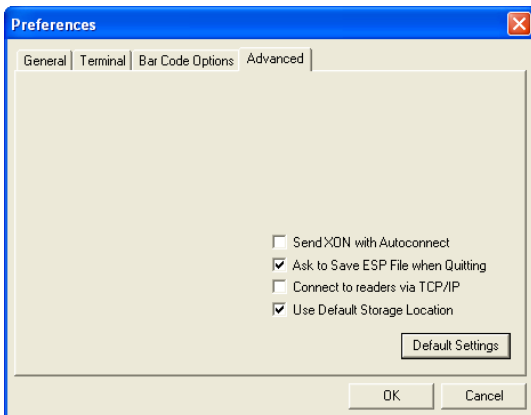

Send XON with Autoconnect

Sends an **XON (Begin Transmission)** command to the reader before starting the **Autoconnect** routine.

Ask to Save ESP File when Quitting

When enabled, prompts the user to save a **.esp** file when ending a session.

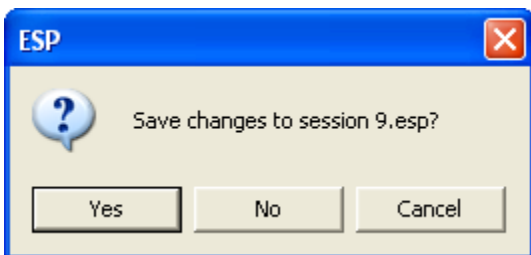

The **.esp** file will be saved in the location of your choice.

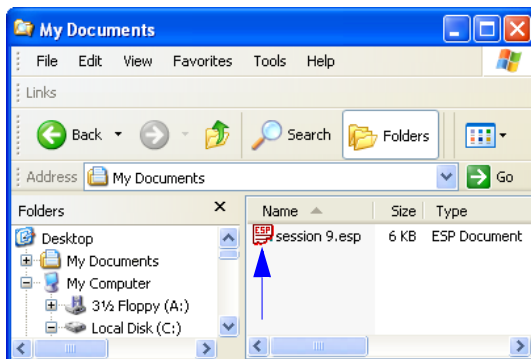

Preferences > Advanced Tab (cont.)

Connect to Readers via TCP/IP

When enabled, shows a **TCP/IP** option on the **Select Protocol** dialog.

Note: This option should only be selected if you intend to connect using an Ethernet adapter.

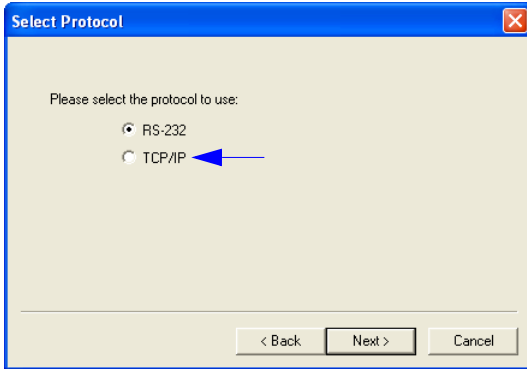

Use Default Storage Location

When enabled, automatically stores data in **ESP's** Application Data folder.

Document Memo

The information you type in the **Document Memo** field will appear in a context-sensitive text box whenever your cursor hovers over the **Document Memo** item on the **Options** menu.

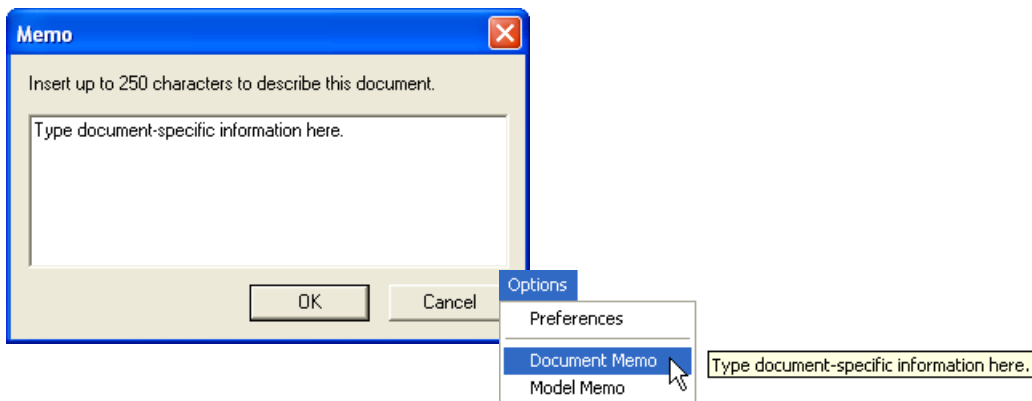

Model Memo

Similar to **Document Memo**, the information you type in the **Model Memo** field will appear in a context-sensitive text box whenever your cursor hovers over the **Model Memo** item on the **Options** menu. Memos created in **Model Memo** are specific to the model enabled when the message was created.

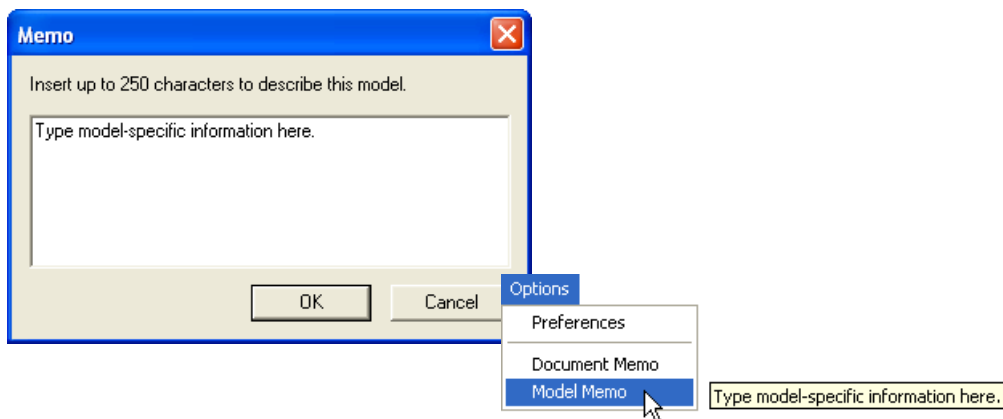

Note: Memos must be saved in a **.esp** file if you want them to be available in your next session. If you do not save your current session, any memos that you have entered during the session will be discarded, and will be unavailable in your next session.

Autoconnect

- If your RS-232 connection attempt fails, you can use **Autoconnect** to establish a connection between the reader and the host.

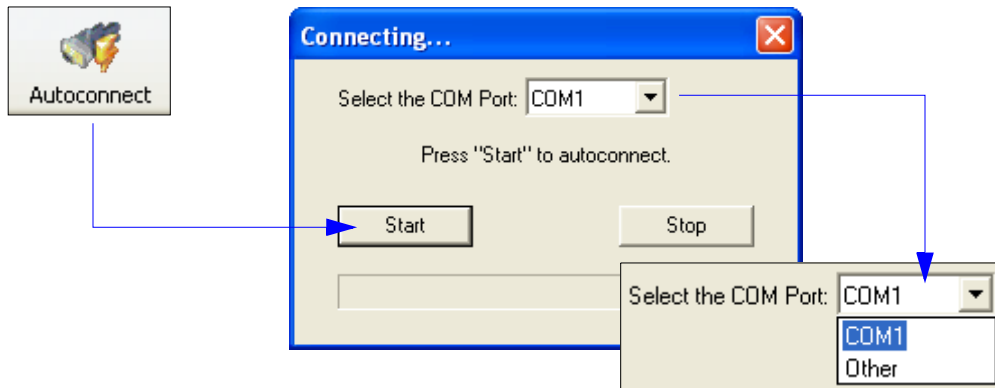

- If your communications port is not the default **COM1**, use the dropdown menu to change your port.

- Once you have chosen the correct port, click **Start** to connect.

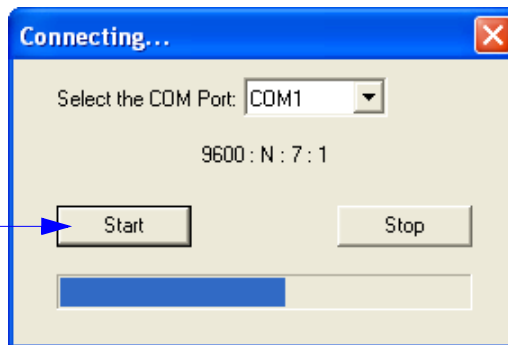

When you are connected, you will see the green connection indicator in the status bar at the bottom right of your screen:

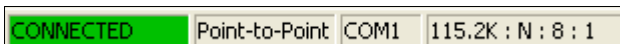

Autoconnect (cont.)

If your host settings cannot be changed to match the reader's settings:

- Click **Connect** on **ESP's** menu toolbar, and then select **Connect** on the dropdown menu.
- When the **Connection Settings** dialog appears, check the **Force Connect** box and click **Connect**.

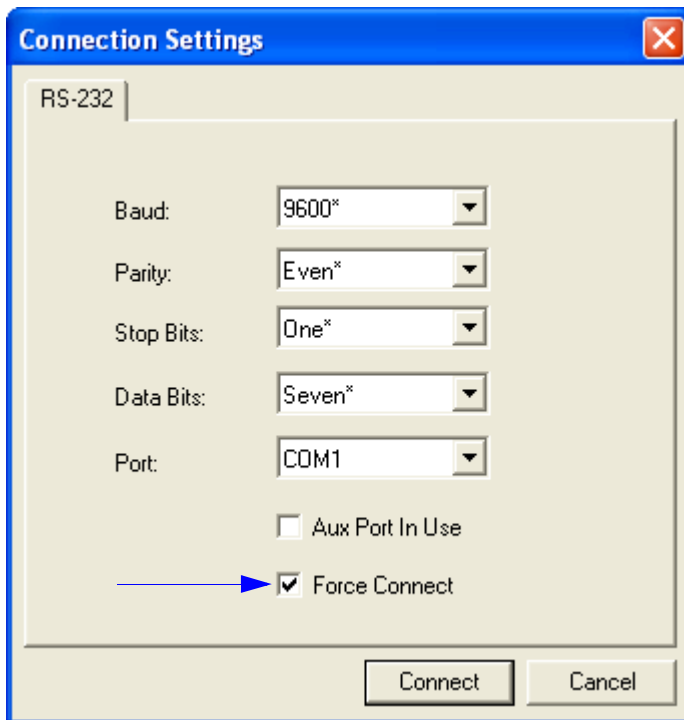

View

The **View** menu allows you to move quickly between interfaces without using the icon buttons on the **App Mode** toolbar.

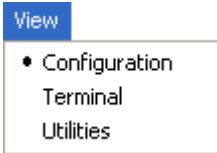

Notice that each menu item corresponds with the icon buttons at the top of the ESP window.

Navigating in ESP

To change reader settings, or to access the **Terminal** or **Utilities** views, click the **App Mode** button.

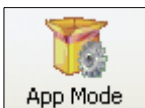

To return to EZ Mode, click the **EZ Mode** button.



To make changes to configuration settings in the tree controls:

1. **Left-click** on the **+** to expand menu items.
2. **Double-click** the desired parameter and **single-click** in the selection box to view options.
3. Place your cursor in the selection box, scroll down to the setting you want to change, and **single-click** the setting.

Parameters	ESP Values
[-] Read Cycle	
Number of Symbols	Single
Time Between Identical Decodes	0
Trigger Mode	Continuous Read
[-] Serial Trigger	
Character (Delimited)	
Start Character (Non-Delimited)	
Stop Character (Non-Delimited)	
No Decode Timeout	2
Decodes Before Output	0
[-] Noread Message	Enabled*
Message	Disabled
Shutter Speed	Enabled*
Beeper	On Good Read

The **X** indicates that the setting is the **default**.

4. **Left-click** again on the open screen to complete the selection.
5. **Right-click** on the open screen and select **Save to Reader** to implement the command in the reader. You can send the command without saving it, or you can send and save the command simultaneously.

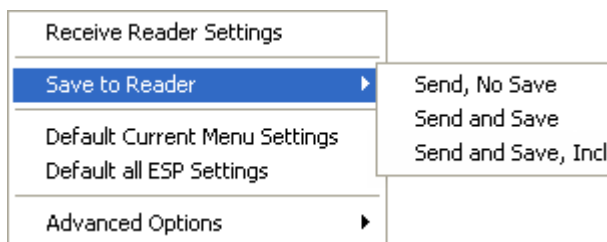

Send/Receive Options

To access **Receive**, **Save**, and **Default** options, click the **Send/Recv** button. You can also access these options by right-clicking in any of the configuration views.



Receiving

From the **Send/Recv** menu, select **Receive Reader Settings**.

Caution: Do not select this option if you do not want to upload the reader's settings. For example, if your **ESP** file has a number of custom settings that you want to maintain and download into the reader, these settings would be lost by choosing **Yes**.

This is useful if you want to receive (upload) the reader's settings and save them as a file for future use. For example, if your reader has settings that you do not want to change, choosing **Yes** would allow you to load those settings to **ESP** and save them in an **ESP** file for later retrieval.

Receiving the reader's settings will also assure that you will not be subsequently saving any unwanted changes that you or someone else has made previously in **ESP**.

Saving



Send, No Save (<A>)

Saves **ESP** settings to current memory.

Send and Save (<Z>)

Activates all changes in current memory *and* saves to the reader for power-on.

Defaulting

When you select **Default Current Menu Settings** or **Default all ESP Settings**, you are only defaulting the **ESP** settings.

Advanced Options

Send Current View

This is the same as **Save to Reader > Send No Save** except that only the commands in the current tree control are sent.

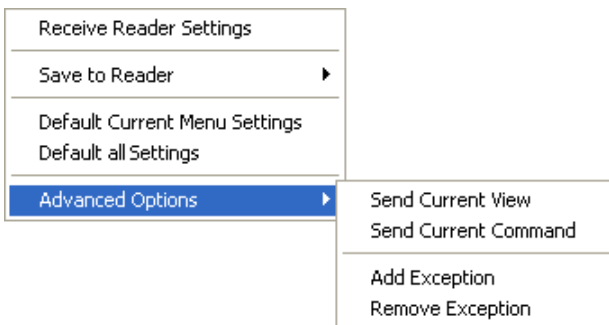

Send Current Command

Saves only the command that is currently selected in the tree control.

Add/Remove Exception

After you perform a **Receive Reader Settings** command¹ and you click on the **Advanced Options > Add Exception** option, you may see a list of serial commands. These are commands that may be in your reader's firmware but are not included in (or are different from) your current version of **ESP**. When exceptions are present, the **Exceptions** button will appear to the right of the other mode buttons (**Communication, Read Cycle, Symbologies**). When no exceptions are present, the button will disappear.

You can edit exception commands by double-clicking on them and changing them as needed.

It is important to note that these commands will be saved to your reader whenever you send a **Save to Reader** command, or an **<A>** or **<Z>** command.

Also, if there is a corresponding **ESP** menu item, the **ESP Value** column for that item will be blank following a **Receive Reader Settings** command.

1. From the **Send/Recv** button, or by right-clicking in any blank section of a tree control.

3 *Communications*

Contents

Communications by ESP	3-2
Communications Serial Commands.....	3-3
Host Port Connections	3-4
Host Port Protocol.....	3-5
Preamble.....	3-6
Postamble	3-7
Keyboard Mapping.....	3-8
USB Keyboard Key Codes.....	3-9

This section explains how to set up communications between the reader and a host. With Microscan's **ESP** (Easy Setup Program), configuration changes can be made in the **ESP** tree controls and then sent and saved to the reader. The user can also send serial commands to the reader via **ESP's Terminal**.

Communications by ESP

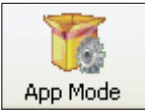

Click this button to bring up the **App Mode** view, then click the **Communication** tab.

Parameters	ESP Values
[-] Communications	USB Native (HID)
[-] RS232	
Baud Rate	9600
Parity	Even
Stop Bits	One
Data Bits	Seven
Host Protocol	Point-to-Point*
[-] Keyboard Mapping	Point-to-Point*
Cap Lock Mode	Point-to-Point with RTS/CTS
Numeric Key	Alpha Numeric
[-] Preamble	Disabled
Preamble Characters	CR
[-] Postamble	Enabled
Postamble Characters	CR LF

To open nested options, **single-click** the +.

To change a setting, **double-click** the setting and use your cursor to scroll through the options.

Communications Serial Commands

Host Port Connections	< K100 , <i>baud rate,parity,stop bits,data bits</i> >
Keyboard Mapping	< K116 , <i>keyboard layout,caps lock mode,number lock</i> >
Host Port Protocol	< K140 , <i>protocol</i> >
Preamble	< K141 , <i>status,preamble character(s)</i> >
Postamble	< K142 , <i>status,postamble character(s)</i> >

Host Port Connections

The following settings define the basic transmission speeds and digital standards that ensure common formatting.

Baud Rate, Host Port

Usage: Can be used to transfer data faster or to match host port settings.

Definition: The rate at which the reader and host transfer data back and forth.

Serial Cmd: <**K100**,*baud rate*,*parity*,*stop bits*,*data bits*>

Default: **9600**

Options: 1 = 1200 2 = 2400 3 = 4800
4 = 9600 5 = 19.2K 6 = 38.4K

Parity, Host Port

Usage: Only changed if necessary to match host setting.

Definition: An error detection routine in which one data bit per character is set to 1 or 0 so that the total number of bits in the data field is either even or odd.

Serial Cmd: <**K100**,*baud rate*,*parity*,*stop bits*,*data bits*>

Default: **Even**

Options: 0 = None **1 = Even** 2 = Odd

Stop Bits, Host Port

Usage: Only changed if necessary to match host setting.

Definition: One or two bits added to the end of each character to indicate the end of the character.

Serial Cmd: <**K100**,*baud rate*,*parity*,*stop bits*,*data bits*>

Default: **One**

Options: **0 = One** 1 = Two

Data Bits, Host Port

Usage: Only changed if necessary to match host setting.

Definition: One or two bits added to the end of each character to indicate the end of the character.

Serial Cmd: <**K100**,*baud rate*,*parity*,*stop bits*,*data bits*>

Default: **Seven**

Options: **0 = Seven** 1 = Eight

Host Port Protocol

Usage: In general, the point-to-point protocols will work well in most applications. They require no address and must use RS-232 or RS-422 communications standards.

Definition: Protocols define the sequence and format in which information is transferred between the reader and the host.

Serial Cmd: <K140,protocol>

Default: **Point-to-Point**

Options: **0 = Point-to-Point**

1 = Point-to-Point with RTS/CTS

Note: The preamble <K141> and postamble <K142> character strings can be used to frame the decoded data in both protocol modes.

Point-to-Point (Standard)

Usage: Used only with RS-232 or RS-422.

Definition: Standard **Point-to-Point** requires no address and sends the data to the host whenever it is available, without a request or handshake from the host.

Serial Cmd: <K140,0>

Point-to-Point with RTS/CTS

Usage: A reader initiates a data transfer with an RTS (request-to-send) transmission. The host, when ready, responds with a CTS (clear-to-send) and the data is transmitted. RTS and CTS signals are transmitted over two dedicated wires as defined in the RS-232 standard. Used only with RS-232.

Definition: **Point-to-Point with RTS/CTS** (request-to-send/clear-to-send) is a simple hardware handshake protocol that allows a reader to initiate data transfers to the host.

Serial Cmd: <K140,1>

Preamble

Preamble Status

Usage: Useful for identifying and controlling incoming data. For example, defining the preamble as a carriage return and a line feed causes each decoded message to be displayed on its own line.

Definition: Defines a one to four character data string that can be added to the beginning of the decoded data.

Serial Cmd: <**K141**,**status**,*preamble character(s)*>

Default: **Disabled**

Options: **0 = Disabled** 1 = Enabled (within any protocol)

Preamble Characters

Serial Cmd: <**K141**,**status**,*preamble character(s)*>

Default: **^M (carriage return)**

Options: To enter control characters within a serial command, hold down the **Ctrl** key while typing the desired character.

Example: <**K141**,**1**,**CTRL-m**> to enter the control character **^M**.

Postamble

Postamble Status

Usage: Useful for identifying and controlling incoming data. For example, defining the postamble as a carriage return and a line feed causes each decoded message to be displayed on its own line.

Definition: Allows the user to enable or disable up to four postamble characters that can be added to the end of the decoded data.

Serial Cmd: <**K142,status**,*postamble character(s)*>

Default: **Enabled**

Options: 0 = Disabled **1 = Enabled (within any protocol)**

Postamble Characters

Serial Cmd: <**K142,status**,*postamble character(s)*>

Default: **^M^J (carriage return/line feed)**

Options: To enter control characters within a serial command, hold down the **Ctrl** key while typing the desired character.

Example: <**K142,1,CTRL-m CTRL-j**> to enter **^M^J**.

Keyboard Mapping

Definition: Allows the user to determine language of the USB keyboard.

Serial Cmd: <**K116**,*keyboard layout*,*caps lock mode*,*number lock*>

Default: **English (U.S.)**

Options: **0 = English (U.S.)**

1 = English (UK)

2 = German

3 = French

4 = Japanese

5 = Spanish

6 = Italian

7 = Universal

8 = Swiss

9 = Czech

Caps Lock Mode

Definition: Allows the user to set caps lock.

Serial Cmd: <**K116**,*keyboard layout*,**caps lock mode**,*number lock*>

Default: **Off**

Options: **0 = Off**

1 = On

2 = Free

Number Lock

Definition: Allows the user to set number lock.

Serial Cmd: <**K116**,*keyboard layout*,*caps lock mode*,**number lock**>

Default: **Alphanumeric**

Options: 0 = Numeric

1 = Alphanumeric

USB Keyboard Key Codes

When in USB keyboard mode, the reader will output the following ASCII symbols as the specified key code. All output data that is not transmitted in USB configuration mode is transmitted as a key code. This includes symbol data, Code 128 application record separator, No Read message, Preamble, and Postamble.

Hex	Key Code	Hex	Key Code	Hex	Key Code
00	Ctrl+@	D2	F3	F7	Right Ctrl up
01	Ctrl+A	D3	F4	F8	Right Shift down
02	Ctrl+B	D4	F5	F9	Right Shift up
03	Ctrl+C	D5	F6	FA	Left Win down
04	Ctrl+D	D6	F7	FB	Left Win up
05	Ctrl+E	D7	F8	FC	Right Win down
06	Ctrl+F	D8	F9	FD	Right Win up
07	Ctrl+G	D9	F10		
08	Ctrl+H	DA	F11		
09	Ctrl+I	DB	F12		
0A	Ctrl+J	DC	HOME		
0B	Ctrl+K	DD	END		
0C	Ctrl+L	DE	RIGHT Arrow		
0D	Ctrl+M	DF	LEFT arrow		
0E	Ctrl+N	E0	UP arrow		
0F	Ctrl+O	E1	DOWN arrow		
10	Ctrl+P	E2	Page Up		
11	Ctrl+Q	E3	Page Down		
12	Ctrl+R	E4	TAB		
13	Ctrl+S	E5	Back TAB		
14	Ctrl+T	E6	ESC		
15	Ctrl+U	E7	ENTER		
16	Ctrl+V	E8	Backspace		
17	Ctrl+W	E9	Delete		
18	Ctrl+X	EA	Left Alt down		
19	Ctrl+Y	EB	Left Alt up		
1A	Ctrl+Z	EC	Left Shift down		
1B	Ctrl+[ED	Left Shift up		
1C	Ctrl+\	EF	Left Ctrl down		
1D	Ctrl+]	F0	Left Ctrl up		
1E	Ctrl+^	F3	Numeric Pad Enter		
1F	Ctrl+_	F4	Right Alt down		
D0	F1	F5	Right Alt up		
D1	F2	F6	Right Ctrl down		

4 Read Cycle

Contents

Read Cycle by ESP	4-2
Read Cycle Serial Commands.....	4-3
MS-2 Read Cycle Overview.....	4-4
Number of Symbols	4-5
Time Between Identical Decodes	4-6
Trigger Mode	4-7
Continuous Read 1 Output Emulation	4-9
Serial Trigger Character (Delimited).....	4-10
Start Trigger Character (Non-Delimited).....	4-11
Stop Trigger Character (Non-Delimited).....	4-12
No Decode Timeout.....	4-13
Decodes Before Output	4-14
No Read Message.....	4-15
Shutter Speed.....	4-16
Beeper	4-17

After you've established communications you will need to address the spatial and timing parameters associated with your application. This section explains those parameters.

Read Cycle by ESP

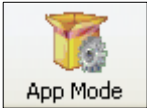

Click this button to bring up the **App Mode** view, and then click the **Read Cycle** tab.

Parameters	ESP Values
[-] Read Cycle	
Number of Symbols	Single
Time Between Identical Decodes	0
Trigger Mode	Continuous Read
[-] Serial Trigger	
Character (Delimited)	G5
Start Character (Non-Delimited)	0x00 NUL
Stop Character (Non-Delimited)	0x00 NUL
No Decode Timeout	2
Decodes Before Output	0
[-] Noread Message	Enabled*
Message	Disabled
Shutter Speed	Enabled*
Beeper	On Good Read

To open nested options, **single-click** the +.

To change a setting, **double-click** the setting and use your cursor to scroll through the options.

Read Cycle Serial Commands

Trigger Mode	< K200 , <i>trigger mode</i> >
Serial Trigger Character	< K201 , <i>serial trigger character</i> >
No Decode Timeout	< K220 , <i>0,seconds</i> >
Decodes Before Output	< K221 , <i>decodes before output</i> >
Number of Symbols	< K222 , <i>number of symbols</i> >
Start Trigger Character	< K229 , <i>start character</i> >
Stop Trigger Character	< K230 , <i>stop character</i> >
Time Between Identical Decodes	< K503 , <i>time between identical decodes</i> >
Reader Setup	< K522 , <i>shutter speed,minimum speed,maximum speed</i> >
Beeper	< K702 , <i>beeper mode</i> >
No Read Message	< K714 , <i>status,No Read message</i> >

MS-2 Read Cycle Overview

The MS-2 outputs symbol data as soon as it is decoded. There is no “End of Read Cycle” option. **Multiple** symbol operations are emulated by controlling the read cycle duration and the time allowed between identical consecutive decodes.

The following conditions also apply:

1. In **Single** symbol mode, a read cycle ends only on a decode, falling trigger, or timeout.
2. In **Multiple** symbol mode, the read cycle begins on a triggered event, but starts over after any symbol has been decoded.
3. There is no “new trigger” feature.
4. There is no timeout for **External Level** mode.
5. There is no **Continuous Read 1 Output** setting in **Trigger Mode**, but this setting can be emulated by following the steps described in [Continuous Read 1 Output Emulation](#).

Number of Symbols

Usage: Commonly used in shipping applications where an object contains individual symbols for part number, quantity, and other values.

Definition: This feature allows one trigger event to decode all symbols present.

Conditions: The following conditions apply:

- When **Number of Symbols** is set to **Single**, the read cycle ends when one symbol is decoded and output.
- When **Number of Symbols** is set to **Multiple**, all decoded symbol data (for both the same and different symbols) is output while the read cycle is active and/or no timeout has occurred.
- If set to **Multiple** and **Time Between Identical Decodes** is less than the decode time (typically about 4ms), the same symbol data can be output multiple times.

Number of Symbols

Definition: **Number of Symbols** is the number of different symbols that can be read in a single read cycle.

Serial Cmd: <**K222,number of symbols**>

Default: **1**

Options: 0 = Multiple

1 = Single

Time Between Identical Decodes

Usage: Can be used to prevent repetition of data output. Also useful for emulating **Multiple** symbol operations. When used in conjunction with **Number of Symbols** set to **Multiple**, **Time Between Identical Decodes** can be set so that more than one symbol can be read within a read cycle.

Definition: Determines the length of time that the reader will wait before it outputs the same symbol's data a second time.

Serial Cmd: **<K503,time between identical decodes>**

Default: **0**

Options: 0 to 2550 ms

Trigger Mode

Definition: The **Trigger** is the event that initiates a read cycle.

Serial Cmd: **<K200,trigger mode>**

Default: **Continuous Read**

Options: **0 = Continuous Read**
 2 = External Level
 3 = External Edge
 4 = Serial Data
 5 = Serial Data and Edge

Continuous Read

Usage: **Continuous Read** is useful in testing symbol readability or reader functions. It is not recommended for normal operations.

Definition: In **Continuous Read**, trigger input options are disabled and the reader is always in the read cycle. If a single symbol stays within read range for multiple read cycles, its data will be transmitted repeatedly until it leaves the read range.

The reader sends replies to serial commands that require responses when symbol data is transmitted.

Note: No Read options have no affect on Continuous Read.

Serial Cmd: **<K200,0>**

External Level

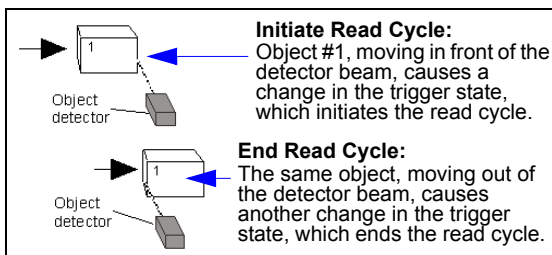

Usage: This mode is effective in an application where the speeds of the conveying apparatus are variable and the time the imager spends reading each object is not predictable. It also allows the user to determine if a No Read has occurred.

Definition: **External Level** allows the read cycle (active state) to begin when a trigger (change of state) from an external sensing device is received. The read cycle persists until the object moves out of the sensor range and the active trigger state changes again.

Serial Cmd: **<K200,2>**

External Edge

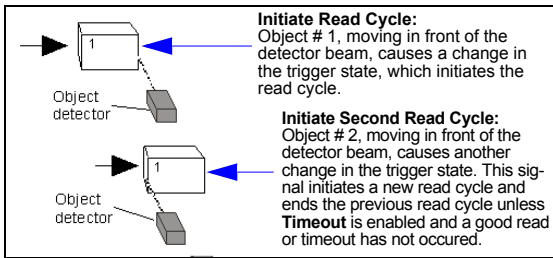

Usage: This mode is highly recommended in any application where conveying speed is constant, or if spacing, object size, or read cycle timeouts are consistent.

Definition: **External Edge**, as with Level, allows the read cycle (active state) to begin when a trigger (change of state) from an external sensing device is received. However, the passing of an object out of sensor range does not end the read cycle. The read cycle ends with a good read output, or, depending on the **End of Read Cycle** setting, a timeout or new trigger occurs.

Serial Cmd: <K200,3>

Serial Data

Usage: **Serial Data** is effective in a highly controlled environment where the host knows precisely when the object is in the field of view. It is also useful in determining if a No Read has occurred.

Definition: In **Serial Data**, the reader accepts an ASCII character from the host or controlling device as a trigger to start a read cycle. A **Serial Data** trigger behaves the same as an **External Edge** trigger. Serial commands are entered inside angle brackets, as shown here: <>.

Serial Cmd: <K200,4>

Note: In **Serial Data**, sending a non-delimited start serial character will start a read cycle; however, a non-delimited stop serial character has no effect.

Serial Data and Edge

Usage: **Serial Data and Edge** is seldom used but can be useful in an application that primarily uses an external sensing device but occasionally needs to be triggered manually.

An auxiliary terminal can be connected to the auxiliary port so the user can send the serial trigger character through the reader to the host.

Definition: In this mode the reader accepts either a serial ASCII character or an external trigger pulse to start the read cycle.

Serial Cmd: <K200,5>

Note: In **Serial Data**, sending a non-delimited start serial character will start a read cycle; however, a non-delimited stop serial character has no effect.

Continuous Read 1 Output Emulation

Usage: **Continuous Read 1 Output** can be useful in applications where it is not feasible to use a trigger and all succeeding symbols contain different information. It is also effective in applications where the objects are presented by hand.

The MS-2 does not offer this feature, but it can be emulated by following the steps described below.

Definition: In **Continuous Read 1 Output Emulation**, the trigger must be active (grounded) for as long as the MS-2 needs to be scanning symbols. The MS-2 will only output symbol data once while that symbol remains in the MS-2's field of view. If the symbol is removed and then presented again, it must be removed from the field of view for the amount of time specified in the **Time Between Identical Decodes** value before the MS-2 will decode the symbol again. However, if a new symbol is presented, the MS-2 will decode it and output symbol data immediately.

Setting Up Continuous Read 1 Output Emulation

1. Set **Number of Symbols** to **Multiple**.

A screenshot of a software interface showing a dropdown menu for 'Number of Symbols'. The menu is open, displaying two options: 'Multiple' (which is highlighted in blue) and 'Single*'. The background of the menu is white, and the text is black.

Serial Cmd: **<K222,0>**

2. Set **Time Between Identical Decodes** to **500 (ms)**.

A screenshot of a software interface showing a spinner control for 'Time Between Identical Decodes'. The value '500' is entered in the text box, and the unit '(0 - 2550) ms' is shown to the right. The spinner arrows are visible.

Serial Cmd: **<K503,500>**

3. Set **Trigger Mode** to **External Level**.

A screenshot of a software interface showing a dropdown menu for 'Trigger Mode'. The menu is open, displaying five options: 'Continuous Read*', 'External Level' (which is highlighted in blue), 'External Edge', 'Serial Data', and 'Serial Data and Edge'. The background of the menu is white, and the text is black.

Serial Cmd: **<K200,2>**

Important: Continuous Read 1 Output Emulation is not recommended for automated environments, because there is typically no reliable way to verify whether or not a symbol was missed.

Serial Trigger Character (Delimited)

Usage: Allows the user to define the trigger character and delimiters that start and stop the read cycle.

Definition: A serial trigger is considered an online host command and requires the same command format as all host commands. It must be entered within angle bracket delimiters **< >** or, in the case of non-delimited triggers, it must define individual start and stop characters.

Serial Cmd: **<K201,serial trigger character>**

Default: **^] (<GS>)**

Options: Any single ASCII character, including control characters, except NUL (00 in hex), an existing host command character, or an on-line protocol character. Control characters entered on the command line are displayed in the menu as mnemonic characters.

Note: **Serial Data** or **Serial Data and Edge** triggering mode must be enabled for **Serial Trigger Character** to take effect.

Start Trigger Character (Non-Delimited)

- Usage:** Useful in applications where different characters are required to start a read cycle.
- Definition:** A single ASCII host serial trigger character that starts the read cycle and is not enclosed by delimiters such as **<** and **>**.
Non-delimited **Start** characters can be defined and will function according to the trigger event.
When defining **Start** trigger characters, the following rules apply:
- In **External Edge** the reader looks only for the **Start** trigger character and ignores any **Stop** trigger character that may be defined.
 - In **External Level** the **Start** trigger character begins the read cycle and the **Stop** trigger character ends it. Note that even after a symbol has been decoded and the symbol data transmitted, the reader remains in **External Level** trigger read cycle until a **Stop** character is received.
 - In **Serial Data and Edge** trigger mode, either a **Start** trigger character or a hardware trigger can start an edge trigger read cycle.
- Serial Cmd:** **<K229,start trigger character>**
- Default:** **NUL** (00 in hex) (disabled)
- Options:** Two hex digits representing any ASCII character except **XON** and **XOFF**.

Stop Trigger Character (Non-Delimited)

Usage: Useful in applications where different characters are required to end a read cycle.

Definition: A single ASCII host serial trigger character that ends the read cycle and is not enclosed by delimiters such as < and >.

Non-delimited **Stop** characters can be defined and will function according to the trigger event.

When defining **Stop** trigger characters, the following rules apply:

- In **External Edge** the reader looks only for the **Start** trigger character and ignores any **Stop** trigger character that may be defined.
- In **External Level** the **Start** trigger character begins the read cycle and the **Stop** trigger character ends it. Note that even after a symbol has been decoded and the symbol data transmitted, the reader remains in **External Level** trigger read cycle until a **Stop** character is received.
- In **Serial Data and Edge** trigger mode, either a **Start** trigger character or a hardware trigger can start an edge trigger read cycle.

Serial Cmd: <K230,stop trigger character>

Default: **NUL** (00 in hex) (disabled)

Options: Two hex digits representing any ASCII character except **XON** and **XOFF**.

No Decode Timeout

Usage: Useful in tightly-controlled applications that require a read cycle to end before the next object appears.

Definition: The duration of the read cycle as measured from either the beginning of the read cycle or from the last decode.

Serial Cmd: **<K220,0,seconds>**

Note: The first parameter is always a zero (0) and does not change.

Default: **2**

Options: **1 - 4095**

The MS-2 times out if no symbol is decoded during the **No Decode Timeout** period. If a symbol is decoded before the timeout expires, the timeout period starts again.

No Decode Timeout only applies to **Edge**, **Serial Data**, and **Serial Data and Edge** trigger modes.

In **Single** symbol mode (**<K222,1>**), **No Decode Timeout** is the maximum amount of time the reader will attempt to decode after a trigger is activated.

In **Multiple** symbol mode (**<K222,0>**), **No Decode Timeout** is the time in which there are no decodes—not the time since the trigger was activated. That is, if the reader continues to decode symbols presented to it, it will not exit the read cycle unless the time between decodes exceeds the time set in **No Decode Timeout**.

For **Level** trigger mode, the read cycle ends when the trigger falls, or when a symbol is decoded and output in **Single** symbol mode.

Decodes Before Output

Note: When setting up, determine if the reader's scan rate is capable of scanning your longest symbol the required number of times.

Usage: Useful for increasing the reliability of decodes for symbologies that do not have internal error checking.

Definition: The number of decodes required per symbol before its data is sent. Requires the reader to decode a symbol successfully a designated number of times before data is output.

Serial Cmd: **<K221,decodes before output>**

Default: **0**

Options: 0 to 10 (0 = "Auto-adaptive")

Note: If the reader is in **Single** symbol mode and it doesn't achieve the number of required decodes during the read cycle, a **No Read** message will be output.

Note: Higher **Decodes Before Output** settings will decrease the throughput rate.

No Read Message

Note: A **No Read** message can only be transmitted when in **Single** symbol mode and no decodes occur.

Usage: Used in applications where the host needs serial verification that a symbol has not been read.

Definition: When enabled, and if no symbol has been decoded before timeout or the end of the read cycle, the No Read message will be transmitted to the host.

No Read Status

Serial Cmd: <K714,status,No Read message>

Default: **Enabled**

Options: 0 = Disabled **1 = Enabled**

No Read Message

Definition: Any combination of ASCII characters can be defined as the No Read message.

Serial Cmd: <K714,status,**No Read message**>

Default: **No Read**

Options: 1 to 20 ASCII characters.

Note: A **No Read** message is not output when the reader is disabled (when an <I> command has been sent).

Shutter Speed

Shutter Speed allows shutter speed to be controlled automatically, set to a specific value, or defined within a fixed range.

Important: Shutter Speed settings should not be changed unless they are being increased to accommodate a fast line speed in a dynamic application.

Usage: Faster shutter speeds may be necessary in faster-moving applications. Slower shutter speeds are useful in slower, lower-contrast applications.

Definition: **Shutter speed** is the amount of time that the sensor is exposed to light.

Serial Cmd: **<K544,shutter speed>**

Default: **Automatic**

Options: **0 = Automatic**

1 = Slow

2 = Medium

3 = Fast

Beeper

The programmable **Beeper** can be set to indicate a Good Read or a No Read.

Definition: A sustained tone that can be programmed to indicate a Good Read or a No Read. Also beeps in response to a **<Z>** command, a **<Zrd>** command, a firmware download, a parameter default, or a hardware default.

Serial Cmd: **<K702,beeper mode>**

Default: **On Good Read**

Options: 0 = Disabled

1 = On Good Read

2 = On No Read

Disabled

The beeper does not sound at the end of a read cycle.

On Good Read

The beeper sounds at the end of a read cycle if a symbol is decoded and data is output.

On No Read

The beeper sounds at the end of a read cycle if a symbol is not decoded and a No Read was output (or would have been output if No Read had been enabled).

Beeper



5 Symbologies

Contents

- Symbologies by ESP5-2
- Symbologies Serial Commands5-3
- Code 395-4
- Codabar5-6
- Interleaved 2 of 55-8
- Code 128/EAN-1285-10
- Code 935-11
- GS1 DataBar (RSS)5-12
- MSI Code5-13
- Plessey Code5-14
- Industrial 2 of 55-15
- UPC/EAN5-17
- PDF4175-20
- China Postal Code5-21
- Symbology Identifier5-22

This section describes the various symbol types that can be decoded by the MS-2 CCD Reader.

See the following sites for additional symbology information:

<http://www.aimglobal.org/standards/aimpubs.asp>

http://barcodes.gs1us.org/dnn_bcec/Default.aspx?tabid=82

Symbologies by ESP



Click this button to bring up the **App Mode** view, and then click the **Symbologies** tab.

To open nested options, **single-click** the +.

Parameters	ESP Values
<input type="checkbox"/> Symbologies	
<input type="checkbox"/> Code 39	Enabled
<input type="checkbox"/> Code 128/EAN	Disabled
<input type="checkbox"/> Interleaved 2 of 5	Disabled
<input type="checkbox"/> Codabar	Disabled
<input type="checkbox"/> UPC/EAN	
<input type="checkbox"/> Code 93	Disabled
<input type="checkbox"/> Industrial 2 of 5	Disabled
<input type="checkbox"/> MSI Code	Disabled
<input type="checkbox"/> Plessey Code	Disabled
<input type="checkbox"/> DataBar Expanded	Disabled*
<input type="checkbox"/> DataBar Limited	Disabled*
<input type="checkbox"/> DataBar Omnidirectional	Enabled
<input type="checkbox"/> China Postal Code	Disabled
<input type="checkbox"/> PDF417	Enabled
<input type="checkbox"/> Symbology Identifier	Disabled

To change a setting, **double-click** the setting and use your cursor to scroll through the options.

Symbologies Serial Commands

Symbology Identifier	< K450 ,unused,symbology identifier status>
Code 39	< K470 ,status,check character status,check character output status,0,0,minimum symbol length,full ASCII set>
Codabar	< K471 ,status,0,start/stop match output status,0,symbol length status,symbol length,check character status,check character output status>
Interleaved 2 of 5	< K472 ,status,check character status,check character output status,symbol length #1,symbol length #2>
Code 128/EAN 128	< K474 ,status,0,minimum symbol length,1,1,0,application record separator character>
Code 93	< K475 ,status,0,minimum symbol length>
PDF417	< K476 ,status>
DataBar-14 (RSS-14)	< K482 ,status>
DataBar Limited (RSS Limited)	< K483 ,status>
DataBar Expanded (RSS Expanded)	< K484 ,status>
MSI Code	< K486 ,status,check character mode,check character output status,0,minimum symbol length>
Plessey Code	< K487 ,status,check character output status,0,minimum symbol length>
Industrial 2 of 5	< K488 ,status,check character status,check character output status,format,symbol length #1,symbol length #2>
UPC/EAN	< K489 ,UPC-A status,UPC-E status,EAN-8 status,EAN-13 status,supplementals required,supplemental 2 status,supplemental 5 status,UPC-A as EAN-13,UPC-E as UPC-A,EAN-8 as EAN-13>
China Postal Code	< K498 ,check digit mode,min length,max length>

Code 39

- Usage:** Code 39 is the most widely used non-retail 1D symbology.
- Definition:** An alphanumeric symbology with unique start/stop code patterns, composed of 9 black and white elements per character, 3 of which are wide.
- Serial Cmd:** <K470,status,check character status,check character output status,0,0,minimum symbol length,full ASCII set>
- Default:** Enabled
- Options:** 0 = Disabled 1 = Enabled

Check Character Status (Code 39)

- Definition:** When enabled, the reader will verify a Modulus 10 check character in order to identify the decode as successful.
- Serial Cmd:** <K470,status,check character status,check character output status,0,0,minimum symbol length,full ASCII set>
- Default:** Disabled
- Options:** 0 = Disabled 1 = Enabled

Check Character Output Status (Code 39)

- Usage:** Check Character Output Status, when added to the symbol, provides additional data security.
- Definition:** When enabled, the check character is read and output along with the symbol data. When disabled, symbol data is output without the check character.
Note: With Check Character Output Status and an External or Serial trigger option enabled, an invalid check character calculation will cause a No Read message to be transmitted at the end of the read cycle.
- Serial Cmd:** <K470,status,check character status,check character output status,0,0,minimum symbol length,full ASCII set>
- Default:** Disabled
- Options:** 0 = Disabled 1 = Enabled

Minimum Symbol Length (Code 39)

- Usage:** **Minimum Symbol Length** helps prevent truncations and increases data integrity by ensuring that only one symbol length will be accepted.
- Definition:** Specifies the exact number of characters that the reader will recognize (this does not include start and stop characters and check characters). The reader ignores any symbology that is less than the specified length.
- Serial Cmd:** `<K470,status,check character status,check character output status,0,0,minimum symbol length,full ASCII set>`
- Default:** **0**
- Options:** 0 to 32

Full ASCII Set (Code 39)

- Usage:** Must be enabled when reading characters outside the standard character set (0-9, A-Z, etc.)
The user must know in advance whether or not to use the **Full ASCII Set** option. Since **Full ASCII Set** requires two code words to encode one character, it is less efficient.
- Definition:** Standard Code 39 encodes 43 characters; zero through nine, capital “A” through capital “Z”, minus symbol, plus symbol, forward slash, space, decimal point, dollar sign, and percent symbol. When **Full ASCII Set** is enabled, the reader can read the full ASCII character set, from 0 to 255.
- Serial Cmd:** `<K470,status,check character status,check character output status,0,0,minimum symbol length,full ASCII set>`
- Default:** **Disabled**
- Options:** **0 = Disabled** 1 = Enabled

Codabar

Usage: Used in photo-finishing and library applications. Previously used in medical applications, but not typically used in newer medical applications.

Definition: Codabar is a 16-bit character set (0 through 9, and the characters \$, :, /, ., +, and -) with start/stop codes and at least two distinctly different bar widths.

Serial Cmd: <K471,status,0,start/stop output status,0,symbol length status,symbol length,check character status,check character output>

Default: **Disabled**

Options: **0 = Disabled** 1 = Enabled

Start/Stop Output Status (Codabar)

Definition: When enabled, the start and stop characters *will* be present in the data output of the decoded symbol.

When disabled, the start and stop characters will *not* be present in the data output of the decoded symbol.

Note: Because the start and stop characters are included as part of the data, the characters must be included as part of the length in a fixed length mode of operation.

Serial Cmd: <K471,status,0,**start/stop output status**,0,symbol length status,symbol length,check character status,check character output>

Default: **Enabled**

Options: 0 = Disabled **1 = Enabled**

Symbol Length Status (Codabar)

Definition: When set to **Any/Minimum**, any symbol length is considered valid.

When set to **Fixed**, the reader will check the symbol length against the **Symbol Length Status** parameter.

Serial Cmd: <K471,status,0,start/stop output status,0,**symbol length status**,symbol length,check character status,check character output>

Default: **Any/Minimum**

Options: **0 = Any/Minimum** 1 = Fixed

Symbol Length (Codabar)

- Definition:** Specifies the number of characters that the reader will recognize, including start and stop check characters. The
- Note:** When setting **Symbol Length** to any value other than **0**, add **2** to account for reserved spaces. For example, if your symbol has **3** characters, set Symbol Length to **5**.
- Note:** If Symbol Length is set to **0** and Symbol Length Status is set to **Any/Minimum**, all symbol lengths are decoded.
- Serial Cmd:** *<K471,status,0,start/stop output status,0,symbol length status,symbol length,check character status,check character output>*
- Default:** **6**
- Options:** 0 to 32

Check Character Status (Codabar)

- Definition:** When disabled, the reader will not perform any character checking calculations on decoded Codabar symbols.
- When set to **Modulus 16**, the reader will perform a Modulus 16 check character calculation on the symbol. If the symbol does not pass this calculation, it will not be decoded.
- Serial Cmd:** *<K471,status,0,start/stop output status,0,symbol length status,symbol length,check character status,check character output>*
- Default:** **Disabled**
- Options:** **0 = Disabled**
1 = Enabled (Modulus 16)

Check Character Output (Codabar)

- Definition:** When this field is disabled and a check character calculation is enabled, the reader will strip the verified check character from the symbol data output. This condition must be accounted for if a minimum length is also being used.
- When enabled, the reader will output the check character as part of the symbol data. This condition must be accounted for if a minimum length is also being used.
- Serial Cmd:** *<K471,status,0,start/stop output status,0,symbol length status,symbol length,check character status,check character output>*
- Default:** **Disabled**
- Options:** **0 = Disabled** 1 = Enabled

Interleaved 2 of 5

Usage: **Interleaved 2 of 5** has been popular because it is the most dense symbology for printing numeric characters less than 10 characters in length; however, Microscan does not recommend this symbology for any new applications because of inherent problems such as truncation.

Definition: A dense, continuous, self-checking, numeric symbology. Characters are paired together so that each character has five elements, two wide and three narrow, representing numbers 0 through 9, with the bars representing the first character and the interleaved spaces representing the second character. (A check character is highly recommended).

Serial Cmd: <**K472,status,check character status,check character output status,symbol length #1,symbol length #2**>

Default: **Disabled**

Options: **0 = Disabled** 1 = Enabled

Check Character Status (Interleaved 2 of 5)

Usage: This option is not typically used, but it can be enabled for additional security in applications where the host requires redundant check character verification.

Definition: An error correcting routine in which the check character is added.

Serial Cmd: <**K472,status,check character status,check character output status,symbol length #1,symbol length #2**>

Default: **Disabled**

Options: **0 = Disabled** 1 = Enabled

Check Character Output Status (Interleaved 2 of 5)

Definition: When enabled, a check character is sent along with the symbol data for added data security.

Serial Cmd: <**K472,status,check character status,check character output status,symbol length #1,symbol length #2**>

Default: **Disabled**

Options: **0 = Disabled** 1 = Enabled

Symbol Length #1 (Interleaved 2 of 5)

Usage: Useful in applications where 1/2 symbols of a specific length are required.

Definition: The **Symbol Length # 1** field is one of two fields against which the decoded symbol is compared before accepting it as valid or rejecting it.

Serial Cmd: <K472,status,check character status,check character output,**symbol length #1**,symbol length #2>

Default: **10**

Options: 0 to 32

Symbol Length #2 (Interleaved 2 of 5)

Usage: Useful in applications where 1/2 symbols of a specific length are required.

Definition: The **Symbol Length # 2** field is one of two fields against which the decoded symbol is compared before accepting it as valid or rejecting it.

Serial Cmd: <K472,status,check character status,check character output,symbol length #1,**symbol length #2**>

Default: **6**

Options: 0 to 32

Range Modes (Interleaved 2 of 5)

Variable Length

To set for any length, **Symbol Length # 1** and **Symbol Length # 2** must both equal zero.

Minimum Length

To set for minimum length, both **Symbol Length # 1** and **Symbol Length # 2** must be equal to each other and be any number other than zero.

Fixed Length

To set for a fixed length, **Symbol Length #1** and **Symbol Length #2** must not be equal to each other. The symbol will be decoded if the character length is equal to Symbol Length # 1 or Symbol Length # 2. If Symbol Length # 1 equals zero, then the symbol will only be decoded if it is equal to Symbol Length # 2. If Symbol Length # 2 equals zero, then the symbol will only be decoded if it is equal to Symbol Length # 1.

Examples:

Length 1	Length 2	Required Symbol Length
0	0	Any
>0	0	Exactly Length 1
0	>0	Exactly Length 2
>0	>0	Exactly Length 1 or Length 2
>0	Same value as Length 1	Length 1 up to maximum symbol length (1 to 32)

Code 128/EAN 128

- Usage:** **Code 128** is a smaller symbology useful in applications with limited space and high-security requirements.
- Definition:** A very dense alphanumeric symbology. It encodes all 128 ASCII characters, it is continuous, has variable length, and uses multiple element widths measured edge to edge.
- Serial Cmd:** **<K474,status,0,minimum symbol length,1,1,0,application record separator character>**
- Default:** **Disabled**
- Options:** **0 = Disabled** 1 = Enabled

Minimum Symbol Length (Code 128/EAN 128)

- Usage:** **Minimum Symbol Length** helps prevent truncations and increases data integrity by ensuring that only one symbol length will be accepted.
- Definition:** This specifies the exact number of characters that the reader will recognize (this does not include start, stop, and check characters). The reader ignores any symbol not having the specified length.
- Serial Cmd:** **<K474,status,0,minimum symbol length,1,1,0,application record separator character>**
- Default:** **0**
- Options:** 0 to 32

Application Record Separator Character (Code 128/EAN 128)

- Definition:** This is an ASCII character that serves as a separator in formatted output.
- Serial Cmd:** **<K474,status,0,minimum symbol length,1,1,0,application record separator character>**
- Default:** **NUL**
- Options:** Any ASCII character (7 bit)

Code 93

- Usage:** Used in some clinical applications.
- Definition:** Code 93 is a variable-length, continuous symbology employing four element widths. Each Code 93 character has nine modules that may be either black or white. Each character contains three bars and three spaces.
- Serial Cmd:** <**K475,status,0,minimum symbol length**>
- Default:** **Disabled**
- Options:** **0 = Disabled** 1 = Enabled

Minimum Symbol Length (Code 93)

- Definition:** Specifies the minimum number of characters that the reader will recognize, not including the start and stop check characters. The reader ignores any symbol smaller than the specified length.
- Note:** When setting **Minimum Symbol Length** to any value other than **0**, add **1** to account for a reserved space. For example, if your symbol has **3** characters, set Symbol Length to **4**.
- Serial Cmd:** <**K475,status,0,minimum symbol length**>
- Default:** **10**
- Options:** 0 to 32

GS1 DataBar (RSS)

Note: GS1 DataBar symbologies were previously known as “Reduced Space Symbology”, or “RSS”.

DataBar-14 (RSS-14)

Note: DataBar-14 was previously known as “RSS-14”.

Usage: Used in the grocery, retail, and prescription drug industries where 14-digit EAN item identification may be needed.

Definition: DataBar-14 is a minimum length symbology that encodes 14 digits, including a 1-digit indicator. DataBar-14 is 96 modules wide. It can be stacked in two rows, it can read omnidirectionally if printed in full height, or horizontally if height-truncated for small marking.

Serial Cmd: <K482,status>

Default: Disabled

Options: 0 = Disabled
1 = Enabled

DataBar Limited (RSS Limited)

Note: DataBar Limited was previously known as “RSS Limited”.

Usage: DataBar Limited is designed to be read by laser and CCD readers. It is not recommended for omnidirectional slot scanners.

Definition: Encodes a smaller 14-digit symbol (74 modules wide) that is not omnidirectional.

Serial Cmd: <K483,status>

Default: Disabled

Options: 0 = Disabled
1 = Enabled

DataBar Expanded (RSS Expanded)

Note: DataBar Expanded was previously known as “RSS Expanded”.

Usage: Used to encode primary and supplementary data in retail point-of-sale and other applications.

Definition: DataBar Expanded is a variable length symbology that can encode supplementary information in addition to the 14-digit EAN item identification number and is capable of encoding up to 74 numeric or 41 alphabetic characters.

Serial Cmd: <K484,status>

Default: Disabled

Options: 0 = Disabled
1 = Enabled

MSI Code

Status (MSI Code)

Usage: Used for inventory control and the identification of storage containers and locations in warehouse environments.

Definition: **MSI Code** is a numeric, continuous symbology in which each character consists of four bits in a binary format.

Serial Cmd: <**K486,status,check character mode,check character output status,0,minimum symbol length**>

Default: **Disabled**

Options: **0 = Disabled** 1 = Enabled

Check Character Mode (MSI Code)

Definition: This field is set to perform a Modulus 10 calculation by default. It can also be set to perform a Double Modulus 10 calculation.

Serial Cmd: <**K486,status,check character mode,check character output status,0,minimum symbol length**>

Default: **Modulus 10**

Options: **1 = Modulus 10** 2 = Double Modulus 10

Check Character Output Status (MSI Code)

Definition: When this field is enabled, the reader will output the check digit with symbol data. When disabled, the reader will not output the check digit with symbol data.

Serial Cmd: <**K486,status,check character mode,check character output status,0,minimum symbol length**>

Default: **Disabled**

Options: **0 = Disabled** 1 = Enabled

Minimum Symbol Length (MSI Code)

Definition: This field specifies the minimum number of characters the reader will recognize, including a check character.

Serial Cmd: <**K486,status,check character mode,check character output status,0,minimum symbol length**>

Default: **6**

Options: 0 to 32

Plessey Code

Status (Plessey Code)

Usage: Used primarily in library and retail applications.

Definition: Plessey Code consists of pairs of wide and narrow bars representing binary data which, taken in units of 12, define hexadecimal characters.

Serial Cmd: <**K487,status,check character output status,0,minimum symbol length**>

Default: **Disabled**

Options: **0 = Disabled** 1 = Enabled

Check Character Output Status (Plessey Code)

Definition: When this field is enabled, the check character will be output with symbol data. When disabled, the check character will not be output with symbol data.

Serial Cmd: <**K487,status,check character output status,0,minimum symbol length**>

Default: **Disabled**

Options: **0 = Disabled** 1 = Enabled

Minimum Symbol Length (Plessey Code)

Definition: This field specifies the minimum number of characters the reader will recognize, including a check character.

Serial Cmd: <**K487,status,check character output status,0,minimum symbol length**>

Default: **0**

Options: 0 to 32

Industrial 2 of 5

Status (Industrial 2 of 5)

- Usage:** Used primarily in warehouse sortation, photo finishing, and the sequential numbering of airline tickets.
- Definition:** Microscan recommends that Industrial 2 of 5 always be used with fixed symbol length settings in any application. **Symbol Length # 1** and **Symbol Length # 2** can both be set to **0** to allow the reader to decode Industrial 2 of 5 symbols of varying lengths.
- Serial Cmd:** <**K488,status**,check character status,check character output status,format,symbol length #1,symbol length #2>
- Default:** **Disabled**
- Options:** **0 = Disabled** 1 = Enabled

Check Character Status (Industrial 2 of 5)

- Definition:** When this field is enabled, a check character is added.
- Serial Cmd:** <**K488,status**,**check character status**,check character output status,format,symbol length #1,symbol length #2>
- Default:** **Disabled**
- Options:** **0 = Disabled** 1 = Enabled

Check Character Output Status (Industrial 2 of 5)

- Definition:** When this field is enabled, the check character will be output with symbol data. When disabled, the check character will not be output with symbol data.
- Serial Cmd:** <**K488,status**,check character status,**check character output status**,format,symbol length #1,symbol length #2>
- Default:** **Disabled**
- Options:** **0 = Disabled** 1 = Enabled

Format (Industrial 2 of 5)

- DefinitionL** Defines the number of start and stop check characters.
- Serial Cmd:** <**K488,status**,check character status,check character output status,**format**,symbol length #1,symbol length #2>
- Default** **3 start / 3 stop**
- Options:** 0 = 3 start / 3 stop 1 = 2 start / 2 stop

Symbol Length # 1 (Industrial 2 of 5)

Definition: Specifies the number of characters that the reader will recognize, including start, stop and check characters. The reader ignores any symbol with fewer than the specified number of characters. Because Industrial 2 of 5 is a continuous symbology, it is prone to substitution errors. Therefore, a symbol length must be defined and a symbol must contain an even number of characters.

Serial Cmd: <K488,status,check character status,check character output status,format,**symbol length #1**,symbol length #2>

Default: 10

Options: 0 to 32

Symbol Length # 2 (Industrial 2 of 5)

Definition: Specifies the number of characters that the reader will recognize, including start, stop, and check characters. The reader ignores any symbol with fewer than the specified number of characters. Because Industrial 2 of 5 is a continuous symbology, it is prone to substitution errors. Therefore, a symbol length must be defined and a symbol must contain an even number of characters.

Serial Cmd: <K488,status,check character status,check character output status,format,symbol length #1,**symbol length #2**>

Default: 6

Options: 0 to 32

Range Modes (Industrial 2 of 5)

Variable Length

To set for any length, **Symbol Length # 1** and **Symbol Length # 2** must both equal zero.

Minimum Length

To set for minimum length, both **Symbol Length # 1** and **Symbol Length # 2** must be equal to each other and be any number other than zero.

Fixed Length

To set for a fixed length, **Symbol Length #1** and **Symbol Length #2** must not be equal to each other. The symbol will be decoded if the character length is equal to Symbol Length # 1 or Symbol Length # 2. If Symbol Length # 1 equals zero, then the symbol will only be decoded if it is equal to Symbol Length # 2. If Symbol Length # 2 equals zero, then the symbol will only be decoded if it is equal to Symbol Length # 1.

Examples:

Length 1	Length 2	Required Symbol Length
0	0	Any
>0	0	Exactly Length 1
0	>0	Exactly Length 2
>0	>0	Exactly Length 1 or Length 2
>0	Same value as Length 1	Length 1 up to maximum symbol length (1 to 32)

UPC/EAN

UPC-A Status (UPC/EAN)

Usage: Used primarily in point-of-sale applications in the retail industry.

Definition: **UPC** (Universal Product Code) is a minimum length, numeric, continuous symbology. UPC can have two- or five-digit supplemental bar code data following the normal code. The UPC Version A (UPC-A) symbol is used to encode a 12-digit number. The first digit is the number system character, the next five are the manufacturer number, the next five are the product number, and the last digit is the checksum character.

EAN is the European version of the UPC symbology and is used in European market applications.

When enabled, the reader will read UPC-A symbols.

Serial Cmd: <**K489,UPC-A status,UPC-E status,EAN-8 status,EAN-13 status, supplementals required, supplemental 2 status, supplemental 5 status,UPC-A as EAN-13, UPC-E as UPC-A,EAN-8 as EAN-13**>

Default: **Enabled**

Options: 0 = Disabled **1 = Enabled**

UPC-E Status (UPC/EAN)

Definition: This field is enabled by default and will decode all UPC-E symbols.

Serial Cmd: <**K489,UPC-A status,UPC-E status,EAN-8 status,EAN-13 status, supplementals required, supplemental 2 status, supplemental 5 status,UPC-A as EAN-13, UPC-E as UPC-A,EAN-8 as EAN-13**>

Default: **Enabled**

Options: 0 = Disabled **1 = Enabled**

EAN-8 Status (UPC/EAN)

Definition: This field is enabled by default and will decode all EAN-8 symbols.

Serial Cmd: <**K489,UPC-A status,UPC-E status,EAN-8 status,EAN-13 status, supplementals required, supplemental 2 status, supplemental 5 status,UPC-A as EAN-13, UPC-E as UPC-A,EAN-8 as EAN-13**>

Default: **Enabled**

Options: 0 = Disabled **1 = Enabled**

EAN-13 Status (UPC/EAN)

Definition: This field is enabled by default and will decode all EAN-13 symbols.

Serial Cmd: <**K489**,UPC-A status,UPC-E status,EAN-8 status,**EAN-13 status**,supplementals required,supplemental 2 status,supplemental 5 status,UPC-A as EAN-13,UPC-E as UPC-A,EAN-8 as EAN-13>

Default: **Enabled**

Options: 0 = Disabled **1 = Enabled**

Supplementals Required (UPC/EAN)

Definition: A supplemental is a 2 or 5-character symbol appended to the main symbol. When enabled, the reader decodes supplemental symbol data that has been appended to the standard UPC or EAN symbol.

Serial Cmd: <**K489**,UPC-A status,UPC-E status,EAN-8 status,EAN-13 status,**supplementals required**,supplemental 2 status,supplemental 5 status,UPC-A as EAN-13,UPC-E as UPC-A,EAN-8 as EAN-13>

Default: **Disabled**

Options: **0 = Disabled** 1 = Enabled

Supplemental 2 Status (UPC/EAN)

Definition: A 2-character symbol appended to the main symbol.

Serial Cmd: <**K489**,UPC-A status,UPC-E status,EAN-8 status,EAN-13 status,supplementals required,**supplemental 2 status**,supplemental 5 status,UPC-A as EAN-13,UPC-E as UPC-A,EAN-8 as EAN-13>

Default: **Disabled**

Options: **0 = Disabled** 1 = Enabled

Supplemental 5 Status (UPC/EAN)

Definition: A 5-character symbol appended to the main symbol.

Serial Cmd: <**K489**,UPC-A status,UPC-E status,EAN-8 status,EAN-13 status,supplementals required,supplemental 2 status,**supplemental 5 status**,UPC-A as EAN-13,UPC-E as UPC-A,EAN-8 as EAN-13>

Default: **Disabled**

Options: **0 = Disabled** 1 = Enabled

UPC-A as EAN-13 (UPC/EAN)

Definition: When enabled, UPC-A will be transmitted as EAN-13.

Serial Cmd: <**K489**,UPC-A status,UPC-E status,EAN-8 status,EAN-13 status,supplementals required,supplemental 2 status,supplemental 5 status,**UPC-A as EAN-13**,UPC-E as UPC-A,EAN-8 as EAN-13>

Default: **Enabled**

Options: **0 = Disabled** 1 = Enabled

UPC-E as UPC-A (UPC/EAN)

Definition: When enabled, UPC-E will be transmitted as UPC-A.

Serial Cmd: <**K489**,UPC-A status,UPC-E status,EAN-8 status,EAN-13 status,supplementals required,supplemental 2 status,supplemental 5 status,UPC-A as EAN-13,**UPC-E as UPC-A**,EAN-8 as EAN-13>

Default: **Disabled**

Options: **0 = Disabled** 1 = Enabled

EAN-8 as EAN-13 (UPC/EAN)

Definition: When enabled, EAN-8 will be transmitted as EAN-13.

Serial Cmd: <**K489**,UPC-A status,UPC-E status,EAN-8 status,EAN-13 status,supplementals required,supplemental 2 status,supplemental 5 status,UPC-A as EAN-13,UPC-E as UPC-A,**EAN-8 as EAN-13**>

Default: **Disabled**

Options: **0 = Disabled** 1 = Enabled

PDF417

Usage: Used in applications where a large amount of information (over 32 characters) needs to be encoded within a symbol, typically where the symbol is transported from one facility to another. For example, an automobile assembly line might use a single symbol with multiple fields of information that will be read at several stations along the way, without reference to a database.

Definition: A two-dimensional, multi-row (3 to 90), continuous, variable length symbology that has high data capacity for storing up to 2,700 numeric characters, 1,800 printable ASCII characters, or 1,100 binary characters per symbol. Each symbol character consists of 4 bars and 4 spaces in a 17-module structure.

Serial Cmd: **<K476,status>**

Default: **Enabled**

Options: 0 = Disabled **1 = Enabled**

China Postal Code

Definition: When enabled, the MS-1 will read China Postal Code symbols.

Serial Cmd: <**K498**,*status*,*check digit mode*,*min length*,*max length*>

Default: **Disabled**

Options: **0 = Disabled** 1 = Enabled

Check Digit Mode

Definition: When this field is enabled, a check digit is added.

Serial Cmd: <**K498**,*status*,**check digit mode**,*min length*,*max length*>

Default: **Disabled**

Options: **0 = Disabled** 1 = Enabled

Min Length

Definition: Determines the minimum symbol length.

Serial Cmd: <**K498**,*status*,*check digit mode*,**min length**,*max length*>

Default: **11**

Options: 1-48

Max Length

Definition: Determines the maximum symbol length.

Serial Cmd: <**K498**,*status*,*check digit mode*,*min length*,**max length**>

Default: **48**

Options: 1-48

Symbology Identifier

Definition: Symbology Identifier is a standard prefix set of characters that identifies the symbol type.

When enabled, the reader analyzes and identifies the symbology and adds a three-character identifying prefix to the data:

-] (closed bracket character) indicating the presence of a symbology identifier.
- A, C, E, F, G, I, e, P, M
(A = Code 39; C = Code 128/EAN-128; E = UPC/EAN; F = Codabar; G = Code 93; I = Interleaved 2 of 5; e = GS1 DataBar (RSS); P = Plessey Code; M = MSI Code)
- Modifier

Serial Cmd: <K450,unused,symbology identifier status>

Default: Disabled

Options: 0 = Disabled 1 = Enabled

Explanation of Modifiers for Code 39 and Interleaved 2 of 5

- For Code 39 and Interleaved 2 of 5, the modifier indicates **Check Character** and **Check Character Output** status.
- For Code 39 only, Full ASCII must be enabled to see modifiers 4, 5, and 7.

Modifier	Check Character	Check Character Output	Full ASCII conversion performed (Code 39 only)
0	Disabled	N/A	No
1	Enabled	Enabled	No
3	Enabled	Disabled	No
4	Disabled	N/A	Yes
5	Enabled	Enabled	Yes
7	Enabled	Disabled	Yes

Example:]A5 indicates a **Code 39** symbol with **Check Character** and **Check Character Output** enabled and Full ASCII conversion performed.

Explanation of Modifiers for Other Symbologies

- For Code 128/EAN-128, a 1 indicates EAN-128; otherwise the modifier is 0.
- For all other symbologies, the modifier is 0.



6 Terminal

Contents

- Terminal Window..... 6-2
- Find 6-3
- Send 6-4
- Macros..... 6-5
- Terminal Window Menus..... 6-6

This section describes the **Terminal** window and **Macro** functions in **ESP**.

Terminal Window

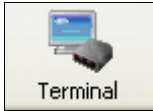

Click this button to display the **Terminal** view.

The following view will appear:

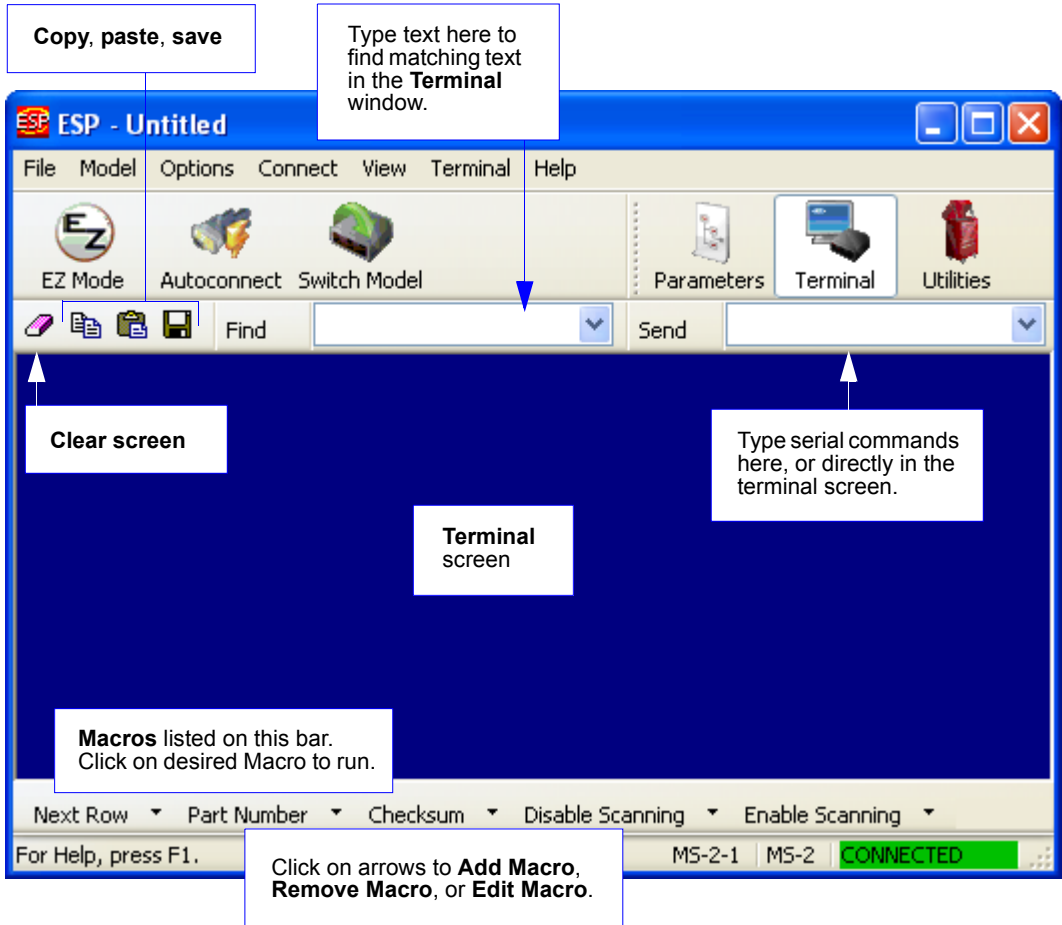

The **Terminal** allows you to send serial commands to the reader by typing commands in the **Send** text field or directly in the Terminal screen, by copying and pasting, or by using Macros.

The Terminal screen also displays symbol data or information from the reader.

You can right-click on the screen to bring up a menu of several options for managing data in the Terminal view.

Find

The **Find** function allows you to enter text strings to be searched for in the Terminal window. For example, data from a series of symbols has been sent to the Terminal and you want to determine if a particular symbol whose data begins with “ABC” has been decoded.

1. Type “ABC” into the **Find** field.

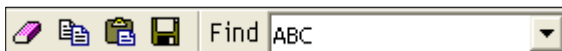

2. Press **Enter**.

The first instance of “ABC” will be highlighted in the Terminal window.

3. Click the **Find** button to the left of the text field to locate additional instances of “ABC”.

Send

The **Send** function allows you to enter serial commands and then send them to the reader.

1. Type the command into the **Send** box.

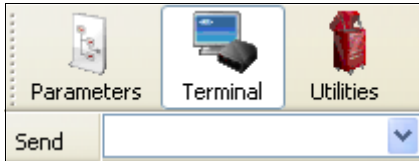

2. Press **Enter** to send the command to the reader.
3. Click the **Send** button to the left of the text field to send the command again.

Macros

Macros can be stored in a macro selection bar, edited in a separate window, and executed by clicking on the macro name.

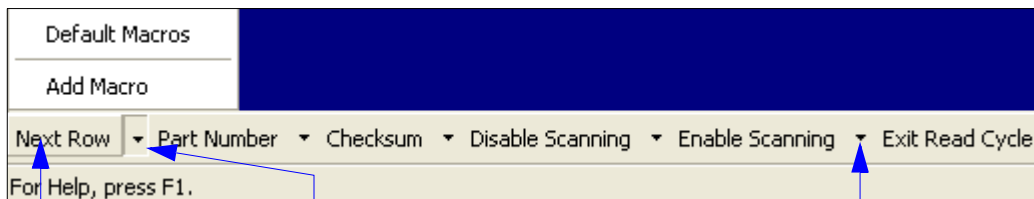

Click on **Next Row** to see the next row of macros

Click on the first arrow here to see **Add Macro** or **Default Macros**. When you default macros, the entire macro set is restored to their original macro commands.

Click on subsequent arrows to edit macros.

When you click on the macro name, the macro is executed in the Terminal window. If the macro is a command, it is sent to the reader at the same time that it is displayed.

Editing a Macro

When you click the arrow next to any macro and select **Edit Macro**, the following dialog appears:

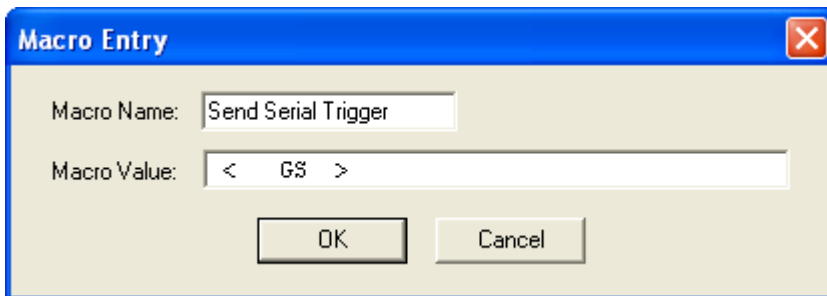

You can edit an existing **Macro Name** or **Macro Value** by typing a new name or value in the corresponding text field and clicking **OK**.

Terminal Window Menus

Right-click on the **Terminal** window to display the following menu:



- **Copy** selected text to clipboard.
- **Paste** from Terminal or other text.
- **Clear** all text in Terminal window.
- **Select All** text in the Terminal window.
- **Save...** brings up a **Save As** dialog.
- **Change Font...** of text in Terminal; brings up a **Font** dialog.
- **Change Echo Font...** to change typed text; brings up a **Font** dialog.
- **Enable Echo** enables Echo text (typed by user).
- **Change Background Color** of Terminal window.
- **Non-Printable Characters** allows the user to hide non-printable characters, or to show them in **Standard** or **Enhanced** format.
- **Default Settings** returns all the above settings to default.
- **Keyboard Macros** allows the user to create new keyboard macro commands that can be sent from function keys (F2, F4, F5, etc.)

Terminal Dropdown Menu

The dropdown **Terminal** menu has **Capture Text**, **Save Current Text**, **Send File**, **Find Next**, and **Find Previous** functions, as well as the same functions defined above.

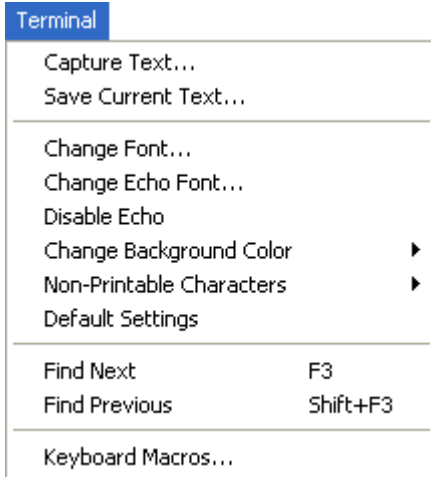

- **Capture Text...** allows the user to append data in real time to a text file. While in operation, the text file cannot be opened. Pause interrupts the capture flow and Stop ends the flow and opens the file.
- **Save Current Text...** saves all text in the Terminal window to a text file.
- **Find Next** searches for a user-defined section of text in the Terminal.
- **Find Previous** operates in the same way as Find Next, but searches backward through Terminal text.

7 Utilities

Contents

Serial Utility Commands	7-2
Read Rate	7-3
Differences from Default.....	7-4
Firmware.....	7-5
Device Control.....	7-7
Default/Reset/Save.....	7-8
Reader Status Request.....	7-9
Hardware Default.....	7-10

Utility commands are generally commands that are performed during reader operations to perform miscellaneous operations on reader hardware. Serial utility commands are not prefaced with a "K" and a numeric value, nor do they require an initialization command (<A> and <Z>). They can be entered from **ESP's Terminal** or **Utilities** views.

Serial Utility Commands

Note: For a list of all K commands, see [Serial Configuration Commands](#).

Type	Command	Name
Part Number	<#>	Display Firmware Part Number
Device Control	<H>	Enable Reader
	<I>	Disable Reader (Continuous, external trigger)
Default/Reset/Save	<A>	Reset (does not save for power-on)
	<Z>	Save Current Settings for Power-On
	<Zrd>	Recall Microscan Default Parameters and Save for Power-On
Read Rate	<C>	Enter Decodes/Second Test
	<Cp>	Enter Decode Percent Test
	<J>	Exit Decodes/Second and Decode Percent Tests
Reader Status Request	<K?>	Configuration Command Status
Trigger	<char>	Serial Trigger Character

Read Rate

Read Rate Commands

Enter Decodes / Second Test

Sending **<C>** instructs the imager to transmit the decodes per second and symbol data (if any). The decode rate can vary dramatically due to the angle and location of the symbol in relation to the field of view. This test is very useful in aligning and positioning the imager during setup.

Enter Decode Percent Test

Sending **<Cp>** instructs the imager to transmit the percentage of decodes and any decoded symbol data.

End Decodes / Second and Decode Percent Tests

Sending **<J>** ends both the Percent test and the Decodes/Second test.

Read Rate Process

The read rate process is expected to operate very similar to a normal read cycle. The differences are:

- The **K222** “number of symbols” parameter does not take effect. Every unique decode is recorded and output at the end of a read rate test cycle.
- The **K221** “good decodes to read” parameter does not take effect. Only one decode is required to be recorded and output.
- System time is recorded at the beginning and end of the test, and an exact number of scan frames are captured and processed.

Differences from Default

Clicking the **Differences from Default** button will cause **ESP** to check all stored configuration settings and compare them to default settings. All settings that are different than default will appear in the left column (shown below), and descriptions of those settings will appear in the right column.

Click this button for a list of **ESP** configuration settings that are different than default settings.

Configuration Identifier	Description
<K200,4>	Mode (Serial Data)
<K201h,52>	Character (Delimited) (R)
<K220,,1000>	Read Cycle Timeout (1000)
<K470,0>	Code 39 (Disabled)

Send configuration settings to the reader without saving by clicking **Send to Reader**.

Click **Save As** to save the report as plain text or a tab-delimited text file.

Send configuration settings to the reader and save in ESP by clicking **Send and Save**.

- To save the **Differences from Default** report, either as plain text or as a tab-delimited text file, click **Save As**.
- Click **Send and Save** to send the settings to the reader and save them, or **Send to Reader** to send the settings without saving them.

Important: The use the **Differences from Default** feature, you must connect to the MS-2 and **Receive Reader Settings** via the **Send/Recv** button on the toolbar.



Firmware

Firmware Update

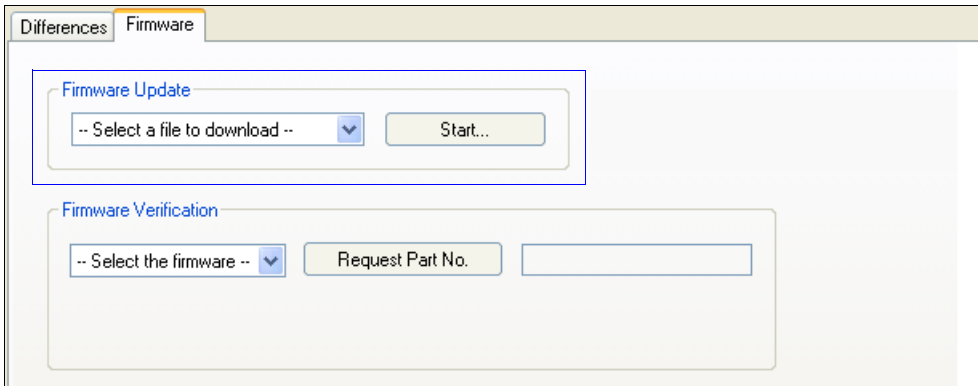

Firmware Update is used to download application code to the reader. Application code versions are specific to your reader. Consult with your sales representative before downloading application code. If needed, application code will be sent to you.

To download application code:

1. Be sure that the reader is connected to the host computer.
2. Apply power to the reader.
3. In the **Firmware Update** dropdown menu, select **App Code** and then click the **Start** button. This will open a dialog that allows you to browse for the application code file.
4. Navigate to where the application code file is located on your host computer and select the file.
5. Allow approximately a minute for firmware to download.

As the application code begins to download, the reader will be silent, the LEDs will flash intermittently, and a progress indicator at the bottom of the ESP window will show when the download is complete.

6. Verify that application code has been updated.

Caution: Do not interrupt power or disconnect the host cable while download is in progress.

Firmware Verification

ESP allows you to send a request to the MS-2 for the application code part number.

1. Click the **Firmware** tab.
2. From the dropdown menu to the left of the **Request Part No.** button, select **App Code**.
3. The application code part number will be displayed in the text field to the right of the **Request Part No.** button.

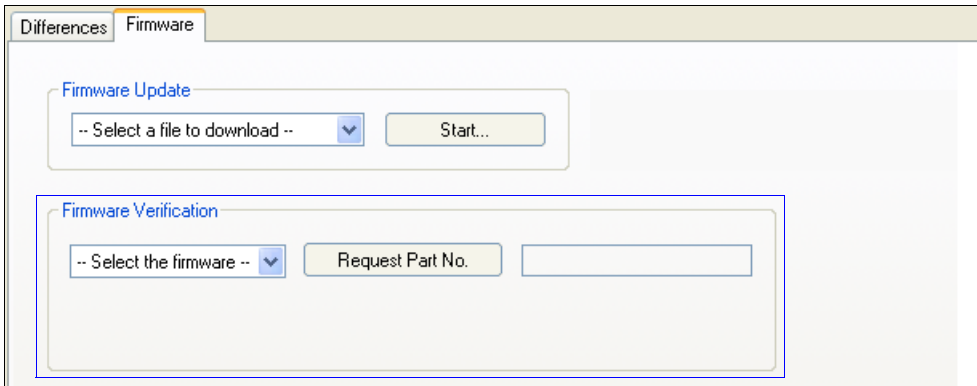

Device Control

Disable Reader

Usage: This feature is useful during extended periods when no symbols are being decoded, or when the reader is being configured.

Definition: Sending <I> will turn the reader off.

Serial Cmd: <I>

Note: <I> only disables **Continuous Read** and the external trigger. Serial triggers will activate a read cycle.

Enable Reader

Definition: Sending <H> allows the reader to trigger on any available trigger source.

Serial Cmd: <H>

Default/Reset/Save

Understanding and controlling your MS-2's active, saved, and default settings is critical to its successful operation.

	<i>Function</i>	<i>Serial Cmd</i>	<i>ESP (first, right-click in any menu tree)^a</i>
Reset (not saved for power-on) Save for Power-on	Reset	<A>	Save to Reader, Send No Save
	Save Current Settings for Power-On	<Z>	Save to Reader, Send and Save
	Recall Microscan Default Parameters and Save for Power-On	<Zrd>	No

a. When you right-click in a menu tree and select **Default Current Menu Settings** or **Default All ESP Settings**, it is important to note that only **ESP** settings are defaulted. To save these defaults to the MS-2 itself, you need to follow up with a **Save to Reader, Send and Save** command.

Reset

Reset (“A” command) affects only current settings (active memory) and does not save for power-on.

Save for Power-On

Power-on parameters (“Z” commands) are saved, recalled, and loaded into current parameters when power is cycled to the MS-2.

Important: The following commands must be followed by a <Z> to be saved for power-on: **Host Protocol, Baud Rate, Data Bits, Stop Bits, Parity, Trigger Characters (Delimited, Start, Stop), Preamble, Postamble, and No Read Message.**

All other parameters are saved for power-on without a <Z>. However, a <Zrd> affects all parameters.

Reader Status Request

<K?> Configuration Command Status

This is the fastest way to learn the reader's current configuration. Sending this request will return the current settings of all commands, starting with the lowest K command value and ending with the highest K command value.

Hardware Default

To default reader parameters:

1. Power-off the reader.
2. Connect the RTS pin to the RxD pin.
3. Cycle power to the reader. After the reader beeps and the unit's illumination flashes on and off twice, it will have defaulted all user parameters.

Appendices

Contents

Appendix A General Specifications A-2
Appendix B Electrical Specifications A-5
Appendix C Serial Configuration Commands A-6
Appendix D Communications Protocol A-10
Appendix E ASCII Table A-11
Appendix F Operational Tips A-12
Appendix G Using an External Trigger A-13
Appendix H Glossary of Terms A-14

Appendix A — General Specifications

Mechanical

Height: 0.85" (21.6 mm)

Width: 1.75" (44.5 mm)

Length: 1.75" (44.5 mm)

Weight: 2 oz. (57 g)

Design

Sensor: CCD linear image sensor

Optics: 660 nm visible LED, bright and sharp scan line

Scanning Performance

Scan Rate: Up to 530 scans/sec

Decode Rate: Up to 55 per second

Min. X Dimension: Down to 3.3 mil (0.084 mm) on Code 39

Depth of Field: 0.8" to 12.8" (20 mm to 325 mm)

Symbol Width: Up to 7" (178 mm) on 20 mil (0.5 mm) symbol

Communications

Interface: RS-232, USB 1.1 (Keyboard Mode only); Virtual COM serial emulation not supported)

Electrical

Power: 5V +/- 5%, 300 mV p-p max. ripple, 150mA @ 5V (typ.)

Start-Up Time: 175 ms

Symbologies

UPC/EAN, Code 39, Code 128/EAN-128, Interleaved 2 of 5, Industrial 2 of 5, Standard 2 of 5, Codabar, Code 93, Plessey Code, GS1 DataBar, PDF417, China Postal Code

Environmental

Operating Temperature: -20° to 50° C (-4° to 122° F)

Storage Temperature: -30° to 60° C (-22° to 140° F)

Relative Humidity: 20% to 85% (non-condensing)

Shock: 2000G

Vibration: 50G r.m.s.

Connector

Type: 3-foot cable terminated with 15-Pin HD D-sub socket or USB Type A connector

CE Mark

Immunity Designed for: EN 55024:98 ITE

Immunity Standard

Radiated and Conducted Emissions Designed for:

EN 55022:98 ITE Disturbances Class B

Discrete I/O

Trigger Input: 0.0 to 5.0V (Active low)

RS-232 Inputs: +/- 15V

Signal Outputs: Beeper: 4.7 to 5.0V max (High state—4mA source/4mA sink max); RS-232 outputs: +/- 5.0V typ.

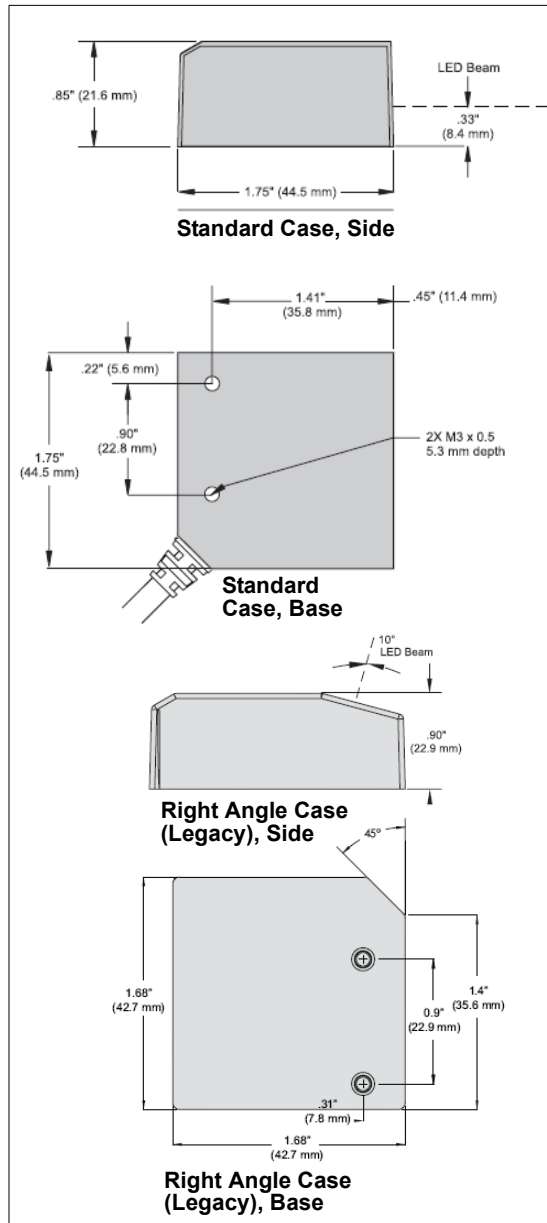

MS-2 CCD Reader Dimensions

Read Ranges

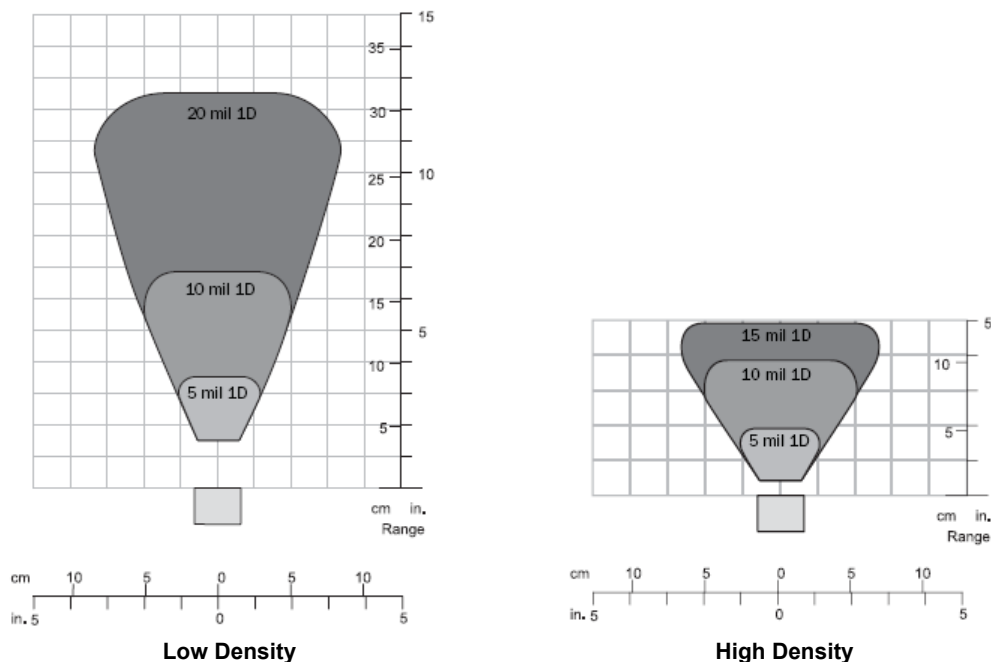

Narrow Bar Width	Read Range	Scan Width
High Density		
.005" (0.127 mm)	0.4 – 1.9" (10 – 48 mm)	2.2" (56 mm) at 1.7" (36 mm)
.010" (0.254 mm)	0.4 – 3.9" (10 – 99 mm)	4.3" (109 mm) at 2.9" (76 mm)
.015" (0.38 mm)	0.4 – 4.9" (10 – 124 mm)	5.0" (127 mm) at 3.5" (109 mm)
Low Density		
.005" (0.127 mm)	1.6 – 3.4" (36 – 84 mm)	2.2" (56 mm) at 2.8" (71 mm)
.010" (0.254 mm)	1.6 – 6.8" (36 – 188 mm)	3.9" (99 mm) at 5.8" (147 mm)
.020" (0.508 mm)	1.6 – 12.4" (36 – 325 mm)	6.7" (170 mm) at 10.8" (274 mm)

Note: Read Range and other performance data are determined using high quality Grade A symbols per ISO/IEC 15415 and ISO/IEC 15416 in a 25° C environment.

General Specifications

FIS Options

MS-2 CCD Reader	
CCD, 32-bit, Low Density, Serial	FIS-0002-0005G
CCD, 32-bit, Low Density, USB	FIS-0002-0006G
CCD, 32-bit, High Density, Serial	FIS-0002-0007G
CCD, 32-bit, High Density, USB	FIS-0002-0008G

Note: Contact your Microscan sales representative for the 16-bit MS-2.

Safety Certifications

FCC, CE, RoHS/WEEE



ISO 9001 Certified
Issued by TÜV USA
Copyright ©2015
Microscan Systems, Inc.

All rights reserved. Specifications subject to change.
Product specifications are given for typical performance at 25°C (77°F) using grade A labels. Performance characteristics may vary at high temperatures or other environmental extremes. Standard Warranty—One-Year Limited Warranty on parts and labor. Extended 3-Year Warranty available.

Appendix B — Electrical Specifications

Power: 5V +/- 5%, 300 mV p-p max. ripple, 150mA @ 5V (typ.)

Start-Up Time: 175 ms

Host Connector / Pin Assignments

15-Pin HD D-sub Socket Connector

Pin	Decoded Operation	In/Out
1	VCC	In
2	TxD	Out
3	RxD	In
4	GND	
5	N/C	
6	RTS	Out
7	Beeper	Out
8	N/C	
9	Trigger	In
10	CTS	In
11	USB D (-)	I/O
12	N/C	
13	Chassis GND	
14	USB D (+)	I/O
15	N/C	

Appendix C — Serial Configuration Commands

Note: For a list of utility commands such as read rate requests, device control options, and reader status requests, see [Serial Utility Commands](#).

Communications	
Host Port Connections	<K100,baud rate,parity,stop bits,data bits>
Keyboard Mapping	<K116,keyboard layout,caps lock mode,number lock>
Host Port Protocol	<K140,protocol>
Preamble	<K141,status,preamble characters>
Postamble	<K142,status,postamble characters>
Read Cycle	
Trigger Mode	<K200,trigger mode>
Serial Trigger Character	<K201,serial trigger character>
No Decode Timeout	<K220,0,seconds>
Decodes Before Output	<K221,decodes before output>
Number of Symbols	<K222,number of symbols>
Start Trigger Character	<K229,start character>
Stop Trigger Character	<K230,stop character>
Time Between Identical Decodes	<K503,time between identical decodes>
Shutter Speed	<K544,shutter speed>
Beeper	<K702,beeper mode>
No Read Message	<K714,status,No Read message>
Symbologies	
Symbology Identifier	<K450,0,symbology identifier status>
Code 39	<K470,status,check character status,check character output status,0,0,minimum symbol length,full ASCII set>
Codabar	<K471,status,0,start/stop match output status,0,symbol length status,symbol length,check character status,check character output status>
Interleaved 2 of 5	<K472,status,check character status,check character output status,symbol length #1,symbol length #2>
Code 128/EAN 128	<K474,status,0,minimum symbol length,1,1,0,application record separator character>
Code 93	<K475,status,0,minimum symbol length>
PDF417	<K476,status>
DataBar-14 (RSS-14)	<K482,status>
DataBar Limited (RSS Limited)	<K483,status>
DataBar Expanded (RSS Expanded)	<K484,status>
MSI Code	<K486,status,check character mode,check character output status,0,minimum symbol length>
Plessey Code	<K487,status,check character output status,0,minimum symbol length>
Industrial 2 of 5	<K488,status,check character status,check character output status,format,symbol length #1,symbol length #2>

UPC/EAN	< K489 ,UPC-A status,UPC-E status,EAN-8 status,EAN-13 status, supplementals required,supplemental 2 status,supplemental 5 status,UPC-A as EAN-13,UPC-E as UPC-A,EAN-8 as EAN-13>
China Postal Code	< K498 ,status,check digit mode,min length,max length>

Serial Command Format

Serial commands are of two types: utility and configuration.

Rules that apply to both Utility and Configuration commands

- A less than **<** and greater than **>** character enclose the commands.
- Commands and data are “case-sensitive.” That is, characters must be entered as upper or lower case, as specified.

Serial Utility Commands

These are sent during operations and are not followed by **<A>** or **<Z>**.

Serial Configuration “K” Commands

These begin with a single “K” character followed by a 3-digit numeric value, data fields, and an initializing command, as follows:

<Knumeric value,data,data,...etc.><initializing command>

An initializing command **<A>** or **<Z>** may follow the command. A **<Z>** initializes the reader’s memory and saves for power-on; an **<A>** initializes the reader’s memory but does not save for power-on.

For example, to enable **UPC** and save the change for power-on, send **<K473,1><Z>**.

To change **Baud Rate** to **4800** and reset without saving changes for power-on, send **<K100,3><A>**.

Serial Configuration Command Conventions

- All data fields (except the last) must be followed by a comma *without a space*.
- Typically, **NUL** cannot be used. The characters **<**, **>**, and **,** can be used, but only if entered as hex pairs.
- All fields preceding a modified field must be included unless there is no change in the preceding fields.
- If there is no change in preceding fields, then commas alone can be entered in these fields. For example, if only the last field in the command **<K100,4,1,0,1>** is changing, it can be entered as **<K100,,,,1>**.
- All fields following a modified field can be omitted. For example, to change **Baud Rate** to **4800** without changing the other host port parameters, send **<K100,3>**.

Concatenating Configuration Commands

Commands can be concatenated (added together) in a single string.

For example, **<K100,4><K222,1><K470,0><A>** sets the **Baud Rate** to **9600**, enables **Multiple** symbol mode, disables **Code 39**, and resets the data buffers (without saving the changes for power-on).

Configuration Command Status Request

To learn the reader's current configuration, send the **Configuration Command Status** command: **<K?>**.

Entering Control Characters in Serial Commands

To enter control characters within a serial command, hold down the **Ctrl** key while typing the desired character.

Example: To enter a carriage return and line feed (**^M^J**), enter **<K141,1,CTRL-m CTRL-j>**.

Appendix D — Communications Protocol

Communications Protocol Command Table

Protocol Command (Mnemonic displayed on menu)	Control Characters (Entered in menu or serial command)	Hex Value	Effect of Command
RES	^D	04	Reset
REQ	^E	05	Request
EOT	^D	04	Reset
STX	^B	02	Start of Text
ETX	^C	03	End of Text
ACK	^F	06	Acknowledge
NAK	^U	15	Negative Acknowledge
XON	^Q	11	Begin Transmission
XOFF	^S	13	Stop Transmission

Appendix E — ASCII Table

Dec	Hex	Mne	Ctrl	Dec	Hex	Ch	Dec	Hex	Ch	Dec	Hex	Ch
00	00	NUL	^@	32	20	SP	64	40	@	96	60	`
01	01	SOH	^A	33	21	!	65	41	A	97	61	a
02	02	STX	^B	34	22	"	66	42	B	98	62	b
03	03	ETX	^C	35	23	#	67	43	C	99	63	c
04	04	EOT	^D	36	24	\$	68	44	D	100	64	d
05	05	ENQ	^E	37	25	%	69	45	E	101	65	e
06	06	ACK	^F	38	26	&	70	46	F	102	66	f
07	07	BEL	^G	39	27	'	71	47	G	103	67	g
08	08	BS	^H	40	28	(72	48	H	104	68	h
09	09	HT	^I	41	29)	73	49	I	105	69	i
10	0A	LF	^J	42	2A	*	74	4A	J	106	6A	j
11	0B	VT	^K	43	2B	+	75	4B	K	107	6B	k
12	0C	FF	^L	44	2C	,	76	4C	L	108	6C	l
13	0D	CR	^M	45	2D	-	77	4D	M	109	6D	m
14	0E	SO	^N	46	2E	.	78	4E	N	110	6E	n
15	0F	SI	^O	47	2F	/	79	4F	O	111	6F	o
16	10	DLE	^P	48	30	0	80	50	P	112	70	p
17	11	DC1	^Q	49	31	1	81	51	Q	113	71	q
18	12	DC2	^R	50	32	2	82	52	R	114	72	r
19	13	DC3	^S	51	33	3	83	53	S	115	73	s
20	14	DC4	^T	52	34	4	84	54	T	116	74	t
21	15	NAK	^U	53	35	5	85	55	U	117	75	u
22	16	SYN	^V	54	36	6	86	56	V	118	76	v
23	17	ETB	^W	55	37	7	87	57	W	119	77	w
24	18	CAN	^X	56	38	8	88	58	X	120	78	x
25	19	EM	^Y	57	39	9	89	59	Y	121	79	y
26	1A	SUB	^Z	58	3A	:	90	5A	Z	122	7A	z
27	1B	ESC	^[59	3B	;	91	5B	[123	7B	{
28	1C	FS	^\	60	3C	<	92	5C	\	124	7C	
29	1D	GS	^]	61	3D	=	93	5D]	125	7D	}
30	1E	RS	^^	62	3E	>	94	5E	^	126	7E	~
31	1F	US	^_	63	3F	?	95	5F	_	127	7F	D

Appendix F — Operational Tips

Cleaning

The MS-2 CCD Reader has a hard-coated window that should only be cleaned with alcohol (100% isopropyl).

Mounting

When mounting the MS-2 CCD Reader, do not insulate the stand mount. The bottom panel is the hottest part of the reader and metal-to-metal contact is necessary for heat dissipation.

Appendix G — Using an External Trigger

Two types of inputs are used on Microscan readers. 5 volt devices have NPN trigger inputs. 10-28 volt devices have optoisolated inputs and outputs.

5 Volt Devices

To trigger a 5 volt device, the input has to be pulled down to “signal ground” (NPN). This can be done by relays or by a transistor-sourced signal. If a 5 volt device is used in combination with an IC-332, it must be connected as a 10-28 volt device.

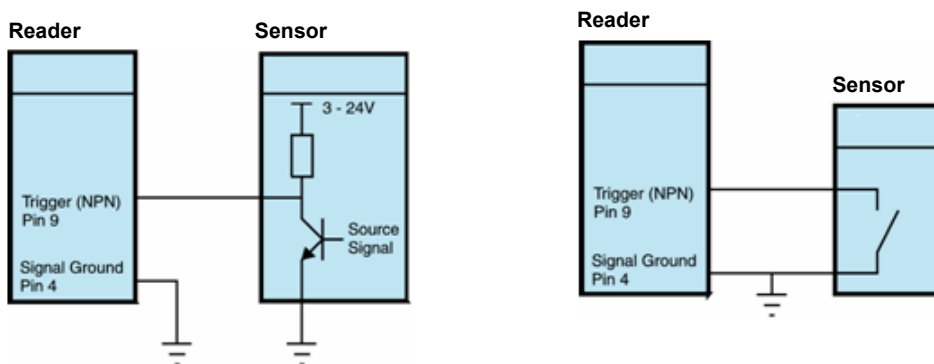

10-28 Volt Devices

To trigger a 10-28 volt device, a small amount of current needs to flow from “Trigger +” to “Trigger -”. If a PNP source is used, “Trigger -” must be connected to “signal ground”. If an NPN source is used, “Trigger +” must be connected to the supply voltage.

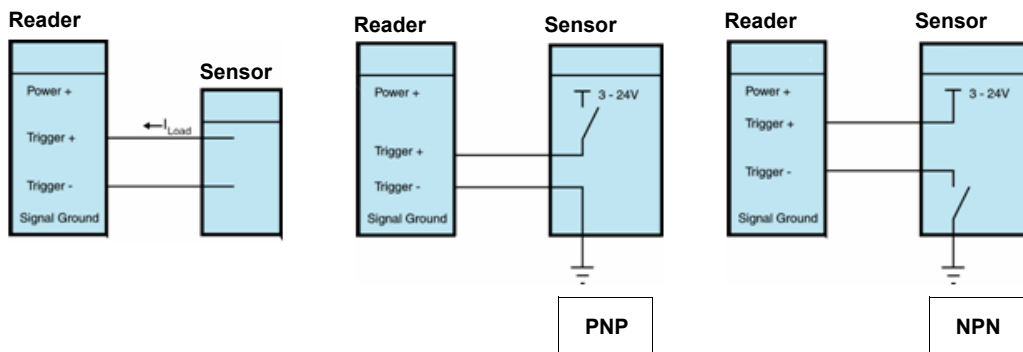

Appendix H — Glossary of Terms

Aberration — The failure of an optical lens to produce an exact point-to-point correspondence between the object and its resulting image. Various types are chromatic, spherical, coma, astigmatism and distortion.

Absorption — The loss of light of certain wavelengths as it passes through a material and is converted to heat or other forms of energy. (–)

Active Illumination — Lighting an area with a light source coordinated with the acquisition of an image. Strobed flash tubes and pulsed lasers are examples.

ADC — See **Analog-to-Digital Converter**.

A/D Converter — See **Analog-to-Digital Converter**.

AGC — See **Automatic Gain Control**.

Ambient Light — Light which is present in the environment of the front end of a reader and generated from outside sources. This light, unless used for actual illumination, will be treated as background noise by the reader.

Analog — A smooth, continuous voltage or current signal or function whose magnitude (value) is the information.

Analog-to-Digital Converter (A/D Converter or ADC) — A device that converts an analog voltage or current signal to a discrete series of digitally encoded numbers (signal) for computer processing.

Application-Specific Integrated Circuit (ASIC) — An integrated circuit that is customized for a particular kind of use, rather than general use. All vision system elements including firmware can be integrated into one ASIC.

Automatic Gain Control (AGC) — Adjustment to signal strength that seeks to maintain a constant level regardless of the distance between a reader and symbol.

Auxiliary Port — RS-232 connection to an auxiliary terminal or device for remote viewing.

Baud Rate — The number of discrete signal events per second; bits per second.

CCD — See **Charge-Coupled Device**.

Charge-Coupled Device (CCD) — A semiconductor device with an array of light-sensitive elements that converts light images into electrical signals.

Check Character — A Modulus 43 or Modulus 10 character that is added to encoded symbol data for additional data integrity.

Connector — A plug or socket on a device or cable providing in/out connectivity for various circuits and pins.

Concentrator — Intermediary device that relays data from readers to a host and commands from the host to the readers or other devices.

DAC — See **Digital-to-Analog Converter**.

Daisy Chain — Linkage of primary and secondary readers allowing data to be relayed up to the host via auxiliary port connections.

Decode — A **Good Read**. The successful interpretation and output of the information encoded in a symbol.

Default — Restores **ROM** or flash settings and initializes serial commands.

- Delimited** — A delimited command or field is bracketed by predefined characters.
- Decode Rate** — The number of good reads per second achieved by a reader.
- Darkfield Illumination** — Lighting of objects, surfaces, or particles at very shallow or low angles, so that light does not directly enter a reader's optical hardware.
- Depth-of-Field** — The in-focus range of a reader. Measured from the distance behind an object to the distance in front of the object with all objects appearing in focus.
- Diffused Lighting** — Scattered soft lighting from a wide variety of angles used to eliminate shadows and specular glints from profiled, highly reflective surfaces.
- Digital-to-Analog Converter (DAC)** — A VLSI circuit used to convert digitally processed images to analog for display on a monitor.
- Digital Signal Processor (DSP)** — A VLSI chip designed for ultra-high-speed arithmetic processing.
- Discrete I/O** — Inputs and outputs characterized by discrete signal transitions from one voltage level to another so that digital switching can occur.
- Direct Memory Access (DMA)** — A capability provided by some computer bus architectures that allows data to be sent directly to memory from an attached device.
- DSP** — See **Digital Signal Processor**.
- EPROM** — See **Erasable Programmable Read-Only Memory**.
- Embedded Memory** — Onboard memory device such as **EPROM** or flash.
- End of Read Cycle** — The time or condition at which the reader stops expecting symbol information to decode.
- Erasable Programmable Read-Only Memory (EPROM)** — A memory chip that retains data when its power supply is turned off; "non-volatile memory".
- External Edge** — Allows a read cycle to be initiated by a trigger signal from an object detector when it detects the appearance of an object (rising edge). The read cycle ends with a good read, a timeout, or a new trigger.
- External Level** — Allows a read cycle to be initiated by a trigger signal from an object detector. The read cycle ends when the object moves out of the detector's range.
- Falling Edge** — A change of state (to inactive) associated with a level trigger.
- Field-Programmable Gate Array (FPGA)** — A semiconductor device containing programmable interconnects and logic components.
- Firmware** — Software hard-coded in non-volatile memory (**ROM**), and closely tied to specific pieces of hardware.
- Fixed Symbol Length** — Increases data integrity by ensuring that only a symbol length will be accepted.
- Focal Distance** — In optics, the distance from the lens to the focal plane.
- Focal Plane** — Usually found at the image sensor, it is a plane perpendicular to the lens axis at the point of focus (-).
- Focus** — Any given point in an image at which light converges; the focal point.
- FPGA** — See **Field-Programmable Gate Array**.
- Full Duplex** — A communications system in which signals can travel simultaneously between devices.

Glossary of Terms

Good Read — A decode. The successful scanning and decoding of the information encoded in a bar code symbol.

Half Duplex — A communications system in which signals can travel between devices in both directions, but not simultaneously.

Host — A computer, **PLC**, or other device that is used to execute commands and process data and discrete signals.

Image Sensor — A device that converts a visual image to an electrical signal; a **CCD**, for example.

Initialize — Implement serial configuration commands into the reader's active memory.

Input — A channel or communications line. Decoded data or a discrete signal that is received by a device.

Ladder Orientation — A linear symbol orientation in which the bars are parallel to the symbol's direction of travel.

Light-Emitting Diode (LED) — A semiconductor device that emits light when conducting current.

Lens — A transparent piece of material with curved surfaces which either converge or diverge light rays.

Multidrop — A communications protocol for networking two or more readers or other devices with a concentrator (or controller) and characterized by the use of individual device addresses and the RS-485 standard.

Normally Closed — A discrete output state that is only active when open.

Normally Open — A discrete output state that is only active when closed.

Object Plane — An imaginary plane in the field of view, focused by a reader's optical system at the corresponding image plane on the sensor.

Output — A channel or communications line. Data or discrete signals that are transmitted or displayed by a device.

Parity — An error detection routine in which one data bit in each character is set to **1** or **0** so that the total number of **1** bits in the data field is even or odd.

Picket Fence Orientation — A linear symbol orientation in which the bars are perpendicular to the symbol's direction of travel.

Pitch — Rotation of a linear or 2D symbol around an axis parallel to the symbol length on the substrate. See the illustration below.

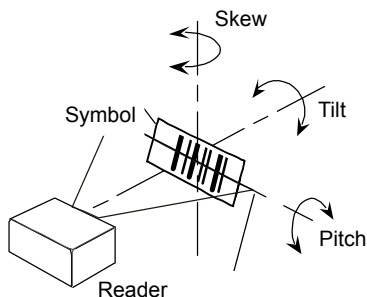

PLC — See **Programmable Logic Controller**.

Port — Logical circuit for data entry and exit. (One or more ports may be included within a single connector.)

Programmable Logic Controller (PLC) — An electronic device used in industrial automation environments such as factory assembly lines and automotive manufacturing facilities.

Protocol — The rules for communication between devices, providing a means to control the orderly flow of information between linked devices.

Random Access Memory (RAM) — A data storage system used in computers, composed of integrated circuits that allow access to stored data in any sequence without movement of physical parts.

Read Cycle — A programmed period of time or condition during which a reader will accept symbol input.

Read-Only Memory (ROM) — A data storage medium used in computers and other electronics, primarily used to distribute firmware.

Skew — Rotation of a linear or 2D symbol around an axis parallel to the symbol height on the substrate. See the illustration under the definition of **Pitch**.

Substrate — The surface upon which a symbol is printed, stamped, or etched.

Symbol Transitions — The transition of bars and spaces on a symbol, used to detect the presence of a symbol on an object.

Symbology — A symbol type, such as Code 39 or Code 128, with special rules to define the widths and positions of bars and spaces to represent specific numeric or alphanumeric information.

Tilt — Rotation of a linear or 2D symbol around an axis perpendicular to the substrate. See the illustration under the definition of **Pitch**.

Trigger — A signal, transition, or character string that initiates a read cycle.

Very Large-Scale Integration (VLSI) — The creation of integrated circuits by combining thousands of transistor-based circuits on a single chip.

VLSI — See **Very Large-Scale Integration**.

