

MICROSCAN.

Quadrus MINI 3 User's Manual



P/N 83-006301 Rev D

Copyright and Disclaimer

Copyright ©2010
Microscan Systems, Inc.

ISO 9001 Certified
Issued by TÜV USA

All rights reserved. The information contained herein is proprietary and is provided solely for the purpose of allowing customers to operate and/or service Microscan manufactured equipment and is not to be released, reproduced, or used for any other purpose without written permission of Microscan.

Throughout this manual, trademarked names might be used. Rather than place a trademark (™) symbol at every occurrence of a trademarked name, we state herein that we are using the names only in an editorial fashion, and to the benefit of the trademark owner, with no intention of infringement.

Disclaimer

The information and specifications described in this manual are subject to change without notice.

Latest Manual Version

For the latest version of this manual, see the Download Center on our web site at:
www.microscan.com.

Technical Support

For technical support, e-mail: helpdesk@microscan.com.

Warranty and Terms of Sale

For Standard Warranty information, see: www.microscan.com/warranty.

Microscan Systems, Inc.

Renton Headquarters

Tel: 425.226.5700 / 800.251.7711
Fax: 425.226.8250

Nashua Office

Tel: 603.598.8400
Fax: 603.577.5818

Microscan Europe

Tel: 011 31 172 423360
Fax: 011 31 172 423366

Microscan Asia Pacific

Tel: 65 6846 1214
Fax: 65 6846 4641

Table of Contents

Chapter 1	Quick Start	
	Step 1 Check Required Hardware	1-2
	Step 2 Connect the System	1-3
	Step 3 Position Imager and Symbol	1-4
	Step 4 Install ESP	1-5
	Step 5 Select Model	1-6
	Step 6 Select Protocol and Connect.....	1-7
	Step 7 Locate the Symbol in the Field of View	1-9
	Step 8 Calibrate.....	1-11
	Step 9 Test Read Rate	1-12
	Step 10 Configure the Imager in ESP	1-13
	Step 11 Save Configuration in ESP.....	1-14
Chapter 2	Using ESP	
	EZ Mode	2-2
	Application Mode	2-3
	Menu Toolbar	2-4
	Autoconnect.....	2-12
	View.....	2-14
	Navigating in ESP.....	2-15
	Send/Receive Options.....	2-16
	Using EZ Trax.....	2-18
Chapter 3	Communications	
	Communications by ESP	3-2
	Communications Serial Commands	3-3
	Host Port Connections.....	3-4
	Host Port Protocol	3-5
	ACK/NAK Options	3-7
	Polling Mode Options	3-8
	RS-422 Status	3-9
	Auxiliary Port Connections	3-10
	Auxiliary Port System Data Status.....	3-18
	Daisy Chain Autoconfigure	3-19
	Response Timeout	3-20
	LRC Status	3-21
	Protocol Configuration Examples	3-22
	USB HID Interface	3-23
	ASCII Character Entry Modifier	3-32
	Preamble	3-33
	Postamble.....	3-34
Chapter 4	Calibration	
	Calibration Serial Commands.....	4-2

Table of Contents

Calibration Overview	4-2
Calibration Options	4-3
Calibration by ESP	4-11
Initiating Calibration	4-13
Additional Notes about Calibration	4-19
Chapter 5 Read Cycle	
Read Cycle by ESP	5-2
Read Cycle Serial Commands	5-3
Read Cycle Setup	5-4
Multisymbol	5-5
Trigger Mode and Filter Duration	5-6
External Trigger Polarity	5-11
Serial Trigger	5-12
Start Trigger Character (Non-Delimited).....	5-13
Stop Trigger Character (Non-Delimited).....	5-14
End of Read Cycle	5-15
Capture Mode.....	5-17
Capture Timing.....	5-22
Image Processing Timeout.....	5-24
Image Storage.....	5-25
Minimum Good Reads.....	5-27
Setting Up the Imager for EZ Trax	5-28
Chapter 6 Symbologies	
Symbologies by ESP	6-2
Symbologies Serial Commands	6-3
Data Matrix	6-4
Aztec Code	6-6
QR Code	6-7
Micro QR Code.....	6-8
Code 39	6-9
Code 128/EAN 128	6-12
BC412	6-15
Interleaved 2 of 5.....	6-16
Code 93.....	6-19
Codabar.....	6-20
UPC/EAN	6-23
Pharmacode	6-27
Postal Symbologies	6-29
GS1 DataBar (RSS)	6-34
PDF417	6-36
MicroPDF417	6-38
Composite	6-39
Narrow Margins/Symbology ID.....	6-40
Background Color.....	6-42

Chapter 7	I/O Parameters	
	I/O Parameters by ESP	7-2
	I/O Parameters Serial Commands.....	7-3
	Symbol Data Output	7-4
	No Read Message.....	7-7
	Bad Symbol Message.....	7-10
	No Symbol Message	7-10
	1D/Stacked Symbology Qualification	7-11
	2D Symbology Qualification	7-12
	Read Duration Output.....	7-18
	Output Indicators	7-19
	Beeper	7-23
	LED Configuration	7-24
	Serial Verification.....	7-25
	EZ Button.....	7-27
	EZ Button Modes	7-29
	Configurable Output 1	7-31
	Trend Analysis Output 1	7-34
	ISO/IEC 16022 Symbol Quality Output 1	7-37
	Diagnostic Output 1	7-40
	Configurable Output 2	7-41
	Trend Analysis Output 2	7-41
	ISO/IEC 16022 Symbol Quality Output 2	7-41
	Diagnostic Output 2	7-41
	Configurable Output 3	7-42
	Trend Analysis Output 3	7-42
	ISO/IEC 16022 Symbol Quality Output 3	7-42
	Diagnostic Output 3	7-42
	Power-On/Reset Counts.....	7-43
	Time Since Reset	7-44
	Service Message	7-45
	Frame Information	7-46
	Image Output.....	7-47
	Database Identifier Output.....	7-50
	Quality Output.....	7-51
	Configuring EZ Trax Output.....	7-52
Chapter 8	Symbol Quality	
	Symbol Quality Serial Commands.....	8-2
	Overview of Symbol Quality	8-3
	Symbol Quality by ESP	8-4
	Symbol Quality Separator/Data Matrix Output Mode	8-8
	ISO/IEC 16022 Symbol Quality Output	8-10
	ISO/IEC 16022 Symbol Quality Output by ESP	8-12
	Microscan Symbol Quality Output	8-13

Table of Contents

Microscan Symbol Quality Output by ESP	8-16
Chapter 9 Matchcode	
Matchcode by ESP	9-2
Matchcode Serial Commands	9-3
Overview of Matchcode	9-4
Matchcode Type	9-5
Match Replace	9-10
Mismatch Replace	9-11
New Master Pin	9-12
Chapter 10 Camera and IP Setup	
Camera and IP Setup by ESP	10-2
Camera and IP Setup Serial Commands	10-3
Video	10-4
Evaluation	10-5
Calibration	10-9
Window of Interest	10-10
Configuration Database	10-13
Dynamic Setup	10-14
Pixel Sub-Sampling	10-15
Camera Settings	10-16
Focal Distance	10-17
Focal Distance Table (Read-Only)	10-18
Increment Focus Position	10-19
Decrement Focus Position	10-19
IP Threshold	10-20
Number of Symbols in Field of View	10-22
Damaged Symbol	10-23
IP Mode	10-24
Hollow Mode	10-26
Mirrored Image	10-27
Illumination Brightness	10-28
Color Processing	10-29
Skew Correction	10-30
Chapter 11 Configuration Database	
Configuration Database Serial Commands	11-2
Number of Active Indexes	11-3
Configuration Database Status	11-4
Database Mode	11-11
Save Current Settings to Configuration Database	11-16
Load Current Settings from Configuration Database	11-17
Request Selected Index Settings	11-18
Request All Configuration Database Settings	11-19
Chapter 12 Terminal	
Terminal Window	12-2

Find.....	12-3
Send	12-4
Macros	12-5
Terminal Window Menus	12-6
Chapter 13 Utilities	
Serial Utility Commands	13-2
Read Rate	13-4
Counters	13-5
Device Control	13-7
Differences from Default	13-8
Master Database	13-9
Firmware.....	13-15
Default/Reset/Save.....	13-18
Imager Status Requests	13-20
Other Operational Serial Commands	13-22
Chapter 14 Output Format	
Output Format Serial Commands	14-2
Output Format Status	14-3
Format Assign	14-4
Format Extract	14-5
Format Insert	14-7
Output Filter Configuration	14-9
Ordered Output Filter.....	14-13
Appendices	
Appendix A General Specifications	A-2
Appendix B Electrical Specifications	A-5
Appendix C Serial Configuration Commands	A-6
Appendix D Communications Protocol	A-13
Appendix E ASCII Table	A-22
Appendix F Interface Standards	A-23
Appendix G Object Detector	A-24
Appendix H Operational Tips.....	A-25
Appendix I USB-to-Serial Virtual COM Port Driver.....	A-26
Appendix J Glossary of Terms	A-29

Index

About the Quadrus MINI 3 Imager

The key features of the Quadrus MINI 3 are:

- Q-Mode ultra-high-speed image processing
- 3 Megapixel optics (QXGA)
- Micro Density and Standard Density options
- Software-adjustable focus
- USB, RS-232, and RS-422/485 connectivity
- Support for both linear and 2D symbologies
- High-output white LED illumination
- A multi-function EZ Button for location, calibration, and symbol reading
- A blue target pattern that identifies the center point of the field of view
- A green flash (visible from all angles) to signal a successful read
- Easy customization for a variety of specific applications

About This Manual

This manual provides complete information on setting up, installing, and configuring the imager. The chapters are presented in the order in which an imager might be set up and made ready for operation.

Highlighting

Serial commands, highlighted command fields, and default command settings are highlighted in **rust bold**. Cross-references and web links are highlighted in **blue bold**. References to **ESP**, its toolbar headings (**Communications**, **Read Cycle**, **Symbologies**, etc.), menu topics, and other points of emphasis, are highlighted in **Bold Initial Caps**.

Host Communications

There are four ways to configure and test the Quadrus MINI 3:

- EZ Button.
- Microscan's Windows-based **ESP** (Easy Setup Program), which offers point-and-click ease of use and visual responses to user adjustments.
- Serial commands, such as **<K100,1>**, that can be sent from **ESP's Terminal** window or another terminal program.
- The tree controls and graphic interfaces in **ESP's App Mode**.

Warning and Caution Summary

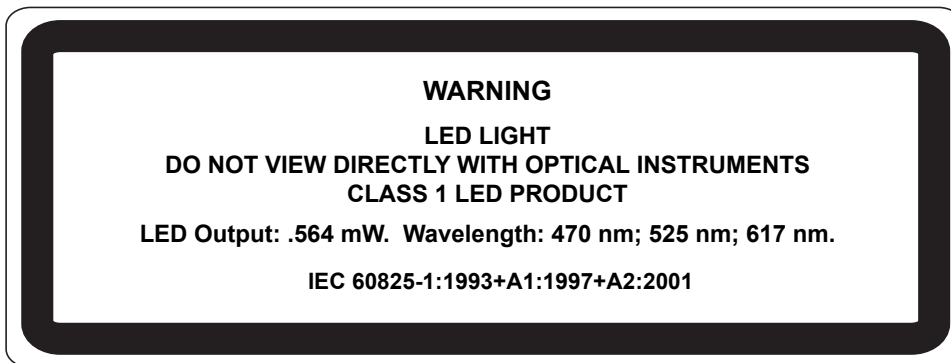

- Viewing the Quadrus MINI 3's LED output with optical instruments such as magnifiers, eye loupes, or microscopes within a distance of 100 mm could cause serious eye injury.
- Maximum LED output: .564 mW.
- Wavelength: 470 nm; 525 nm; 617 nm.
- Location of the Quadrus MINI 3's LED aperture window:



LED Aperture Window

CAUTION: Use of controls or adjustments or performance of procedures other than those specified herein may result in hazardous radiation exposure.

IMPORTANT: The Quadrus MINI 3 is intended for connection to a UL-listed direct plug-in power unit marked Class II and rated 5 VDC at 3.5 Watts, or greater if using electrical accessories.

European models must use a similarly rated Class I or Class II power supply that is certified to comply with standard for safety EN 60950.

Statement of Agency Compliance



The Quadrus MINI 3 has been tested for compliance with FCC (Federal Communications Commission) regulations and has been found to conform to all applicable FCC Rules and Regulations.

To comply with FCC RF exposure compliance requirements, this device must not be co-located or operate in conjunction with any other antenna or transmitter.

Changes or modifications not expressly approved by the party responsible for compliance could void the user's authority to operate the equipment.



The Quadrus MINI 3 has been tested for compliance with CE (Conformité Européenne) standards and guidelines, and has been found to conform to applicable CE standards, specifically the EMC requirements EN 55024:1998+A1:2001+A2:2003, ESD EN 61000-4-2, Radiated RF Immunity EN 61000-4-3, ENV 50204, EFT EN 61000-4-4, Conducted RF Immunity EN 61000-4-6, EN 55022:1998+A1:2000+A2:2003 for Class A products, Class B Radiated Emissions, and Class B Conducted Emissions.

The Quadrus MINI 3 has been tested by an independent electromagnetic compatibility laboratory in accordance with the applicable specifications and instructions.

Statement of RoHS Compliance

All Microscan readers with a 'G' suffix in the FIS number are RoHS-Compliant. All compliant readers were converted prior to March 1, 2007. All standard accessories in the Microscan Product Pricing Catalog are RoHS-Compliant except 20-500013-01 and 98-000039-02. These products meet all the requirements of the European Parliament and the Council of the European Union for RoHS compliance. In accordance with the latest requirements, our RoHS-compliant products and packaging do not contain intentionally added Deca-BDE, Perfluorooctanes (PFOS) or Perfluorooctanoic Acid (PFOA) compounds above the maximum trace levels. To view the documents stating these requirements, please visit:

<http://eur-lex.europa.eu/LexUriServ/LexUriServ.do?uri=CELEX:32002L0095:EN:HTML>

and

<http://eur-lex.europa.eu/LexUriServ/LexUriServ.do?uri=OJ:L:2006:372:0032:0034:EN:PDF>

Please contact your sales manager for a complete list of Microscan's RoHS-Compliant products.

This declaration is based upon information obtained from sources which Microscan believes to be reliable, and from random sample testing; however, the information is provided without any representation of warranty, expressed or implied, regarding accuracy or correctness. Microscan does not specifically run any analysis on our raw materials or end product to measure for these substances.

The information provided in this certification notice is correct to the best of Microscan's knowledge at the date of publication. This notice is not to be considered a warranty or quality specification. Users are responsible for determining the applicability of any RoHS legislation or regulations based on their individual use of the product.

1 Quick Start

Contents

Step 1 Check Required Hardware	1-2
Step 2 Connect the System	1-3
Step 3 Position Imager and Symbol.....	1-4
Step 4 Install ESP	1-5
Step 5 Select Model.....	1-6
Step 6 Select Protocol and Connect	1-7
Step 7 Locate the Symbol in the Field of View	1-9
Step 8 Calibrate	1-11
Step 9 Test Read Rate	1-12
Step 10 Configure the Imager in ESP.....	1-13
Step 11 Save Configuration in ESP	1-14

This chapter is designed to get your Quadrus MINI 3 Imager up and running quickly, using the EZ Button or **ESP** (Easy Setup Program). Following these steps will allow you to get a sense of the imager's capabilities and to test symbol decode performance.

Detailed setup information for installing the imager into your actual application can be found in the subsequent chapters.

Check Required Hardware

Step 1 — Check Required Hardware

Item	Description	Part Number
1	Quadrus MINI 3	FIS-6300-200XG
2	IC-332 Adapter	FIS-0001-0035G
3	IB-131 Interface Box	99-000018-01
4	Power Supply	97-100004-15 (90-264 VAC, 24 VDC)
5	Object Detector (optional)	99-000017-01
6	Communication Cable	61-300026-03

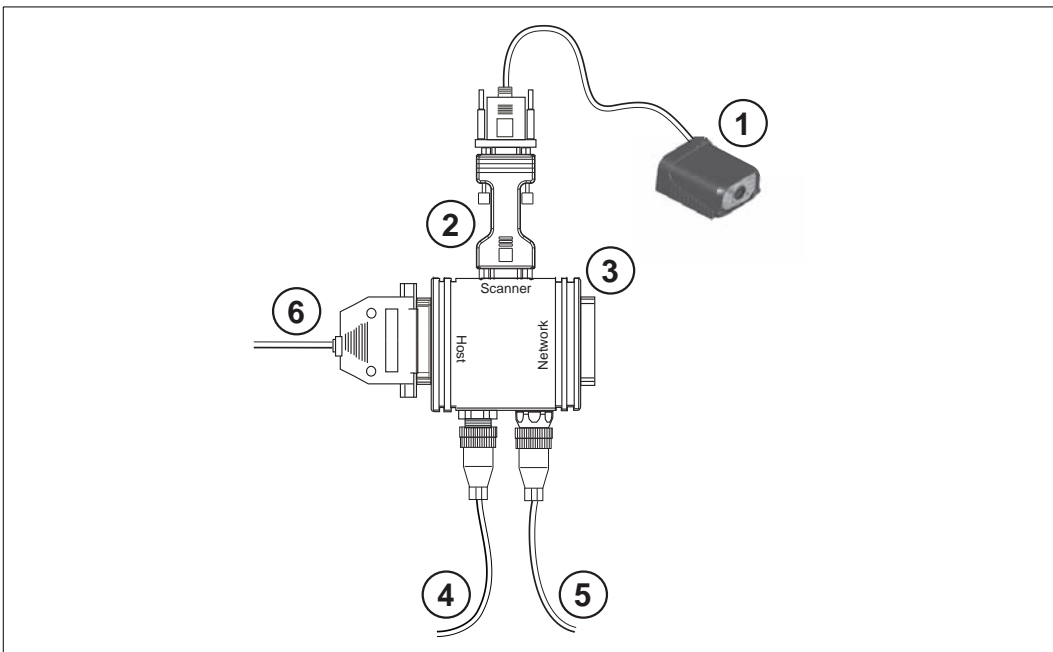

Hardware Required

Caution: Be sure that all cables are connected **BEFORE** applying power to the system. Always power down **BEFORE** disconnecting any cables.

Step 2 – Connect the System

Connecting by RS-232/RS-422/RS-485

- Connect the imager (1) to the IB-131/IC-332 interface (2) and (3).
- Connect the host cable (6) to the host and to the host port on the IB-131 (3).
- Connect the object detector (5) to the IB-131 (3).
- Connect the power supply (4) to the IB-131 (3).
- Apply power to the imager.

Important: If you are using a **USB** model, you must connect the device to the host computer **before** powering-on. Otherwise the unit will not be recognized as a USB device.

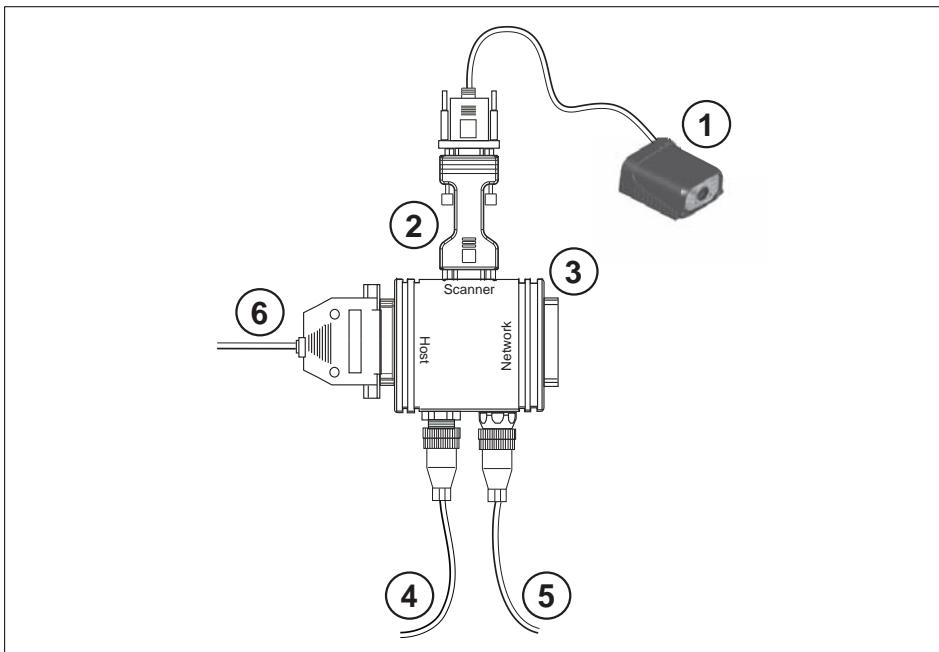

Hardware Configuration

Caution: Be sure that all cables are connected **BEFORE** applying power to the system. Always power down **BEFORE** disconnecting any cables.

Step 3 — Position Imager and Symbol

- Position the imager at a focal distance between **2** and **6** inches from the symbol.
- Tip the imager relative to the symbol to avoid the glare of direct (specular) reflection. The case parting line should be perpendicular to the plane of the symbol by either pitching the symbol or the imager as shown.
- Position the imager in a place with as little ambient light as possible.
- Symbols can be rotated (tilted) at any angle; however, for best results symbols should be aligned with the FOV (field of view).

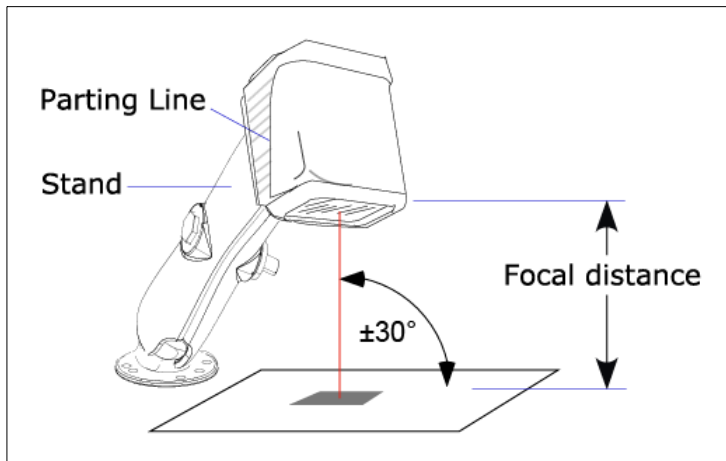

Imager and Symbol Orientation

- In the case of linear symbols, aligning the bars in the direction of their movement (“ladder” orientation) will minimize the chances of blurring, and will produce better reads.

Important: Avoid excessive skew or pitch. Maximum skew is $\pm 30^\circ$; maximum pitch is $\pm 30^\circ$. The illustration below shows skew axis, pitch axis, and tilt axis.

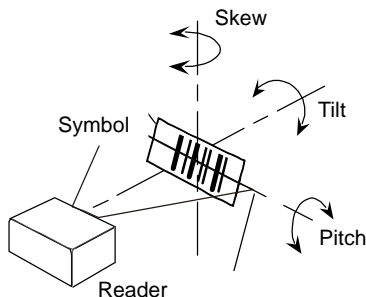

Note: For accuracy of testing and performance, Microscan recommends using a mounting arm adapter kit. Contact your Microscan sales manager for details about mounting arm adapter kits and other accessories.

Step 4 — Install ESP

Easy Setup Program (ESP) is Microscan's proprietary setup and testing application. The purpose of **ESP** is to provide a quick and easy way to set up and configure Microscan readers. When the Quadrus MINI 3 is connected to a host computer (Windows Vista, XP, or 2000), **ESP** can be used to configure reader settings and to set up communications between the reader and host.

If installing from the Microscan Tools CD:

1. Insert the Microscan Tools CD in your computer's CD drive.
2. Select **ESP Software** from the navigation bar at the left of the screen.
3. Click on **ESP Software** under the **Current Version** heading.
4. Click the **Run** button and follow the prompts in the **ESP Setup Wizard**.

Note: During installation, you may see an Internet Explorer Security Warning that states: "The publisher could not be verified." If you see this warning, click **Run** to continue installation.

If downloading from the web:

1. Go to the Download Center at www.microscan.com.
2. Create a new member account or, if you are already a member, enter your user name and password.
3. Navigate to the "Microscan Software" section of the Download Center (near the top of the page).
4. Click on the link showing the latest version of **ESP**. Extract the **ESP** installation files to a location of your choice on the host computer. *Note where your **ESP.exe** file is stored on your hard drive.*
5. At the end of the installation process, the following icon will appear on your desktop:



6. Click the **ESP** icon to start the program.

System Requirements for ESP

- 166 MHz Pentium processor (recommended)
- Windows Vista, XP, or 2000 operating system
- Internet Explorer 5.0 or higher
- 64 MB minimum RAM
- 40 MB minimum disk space
- 800 x 600 pixel minimum 256 color display

Step 5 — Select Model

When you start **ESP**, the following menu will appear:



1. Click the button showing the Quadrus MINI 3.
2. Click **OK**.

Note: You can also double-click the Quadrus MINI 3 button to make your selection.

3. Click **Yes** when this dialog appears:

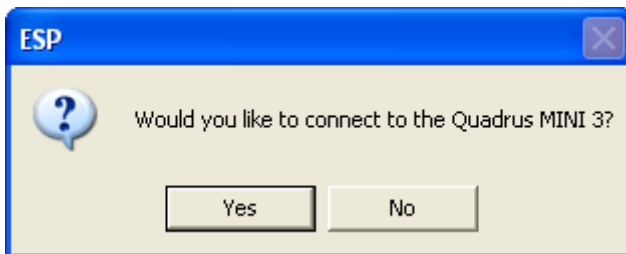

Note: If you need to select another model later, click the **Switch Model** button near the top of the screen or use **Model > New Model** in the menu toolbar.

Step 6 – Select Protocol and Connect

- Choose the connection protocol you are using and click **Next** when the **Select Protocol** dialog appears.

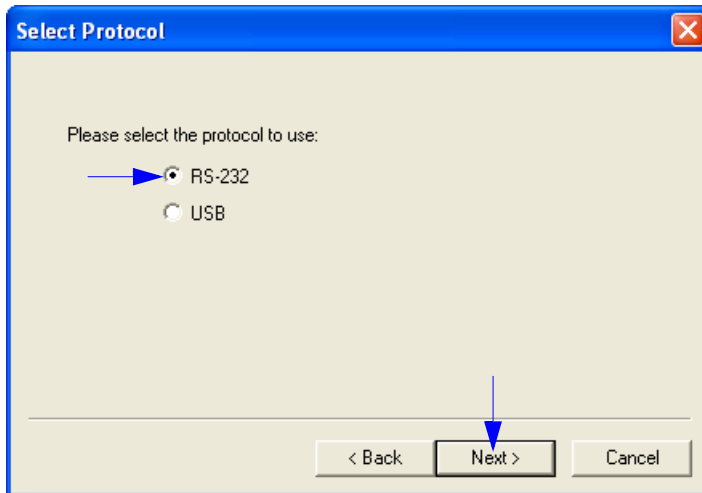

- Once you select your communications mode, follow the prompts to establish your connection.

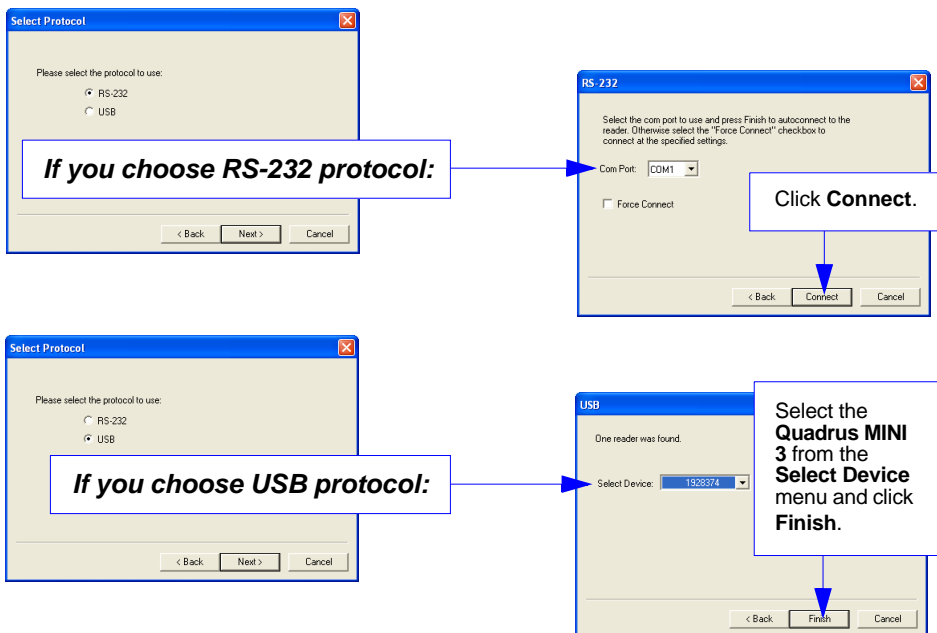

Step 6 — Select Protocol and Connect (cont.)

When you are connected, you will see the green connection indicator in the status bar at the bottom right of your screen.

RS-232: CONNECTED Point-to-Point COM1 115.2K : N : 8 : 1

USB: CONNECTED USB HID

- If your RS-232 connection attempt fails, click the **Autoconnect** button, select a different communications port, and try again.

Note: If your RS-232 host settings cannot be changed to match the imager's settings:

- Click **Connect** on **ESP's** menu toolbar, and then select **Connection Wizard**.
- When the **Select Protocol** dialog appears, select **RS-232** and click **Next**.

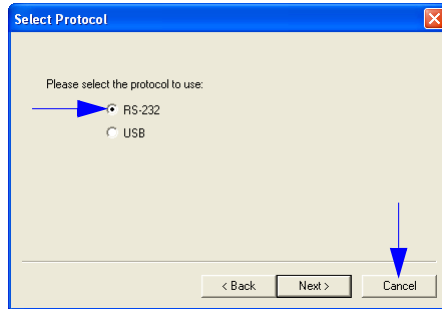

- When the **RS-232** dialog appears, check the **Force Connect** box and click the **Connect** button.

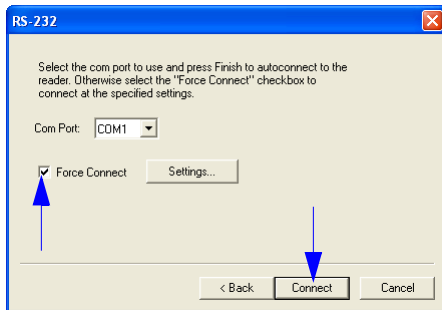

Step 7 — Locate the Symbol in the Field of View

Locate by ESP

- In ESP's **EZ Mode**, click the **Locate** button to enable the blue target pattern.

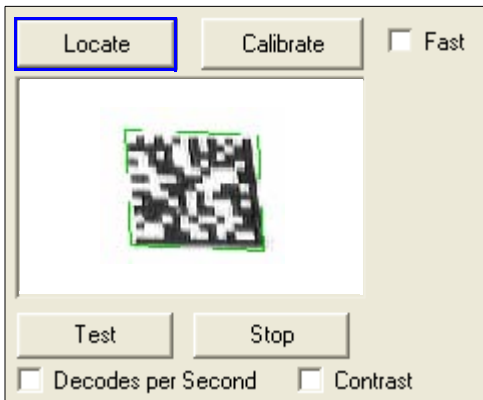

The symbol in the field of view will appear in the video view beneath the **Locate** and **Calibrate** buttons, and you will see the blue target pattern projected from the front of the imager.

- Center the target pattern on the symbol.
At 2 to 3 inches, the pattern resembles an **X**. At 3 to 6 inches, the pattern resembles a **V**.

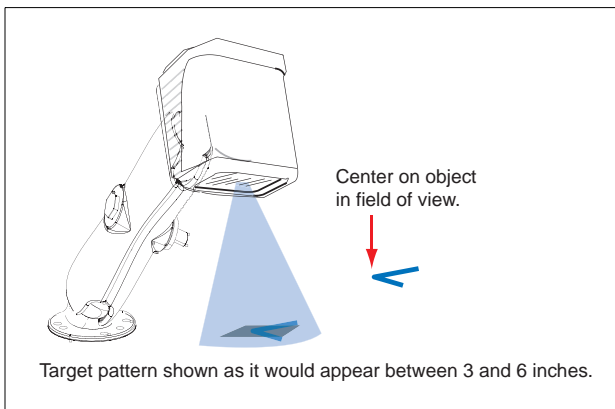

Important: The entire symbol should fall within the field of view (FOV) of the imager. The field of view is what appears in **ESP's Locate/Calibrate** window in **EZ Mode**.

- Click the **Stop** button to end the **Locate** function.

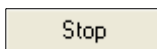

Locate the Symbol in the Field of View

Locate by EZ Button

If you are not connected to a host computer, the EZ Button allows you to locate a symbol in the imager's field of view.

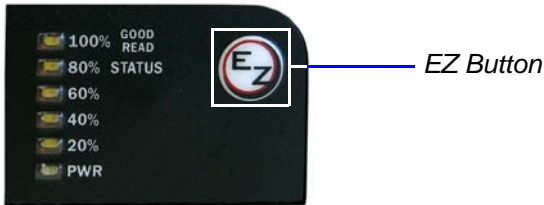

- Hold down the EZ Button for about one second and release when you hear one short beep. The amber **20%** LED will illuminate, and you will see the blue target pattern projected from the front of the imager.
- Center the target pattern on the symbol.

Note: To end all EZ Button functions, press the EZ Button once and quickly release.

Step 8 – Calibrate

Quadrus MINI 3 settings can be adjusted automatically for optimum symbol decoding performance by either the EZ Button or by **ESP**.

During the calibration routine, the reader will flash its amber Read Rate percent LEDs and red illumination LEDs while searching camera settings and determining the best configuration for decoding symbol data. Upon successful completion of this routine, a green LED pattern will flash brightly and illuminate the symbol. If unsuccessful, the imager will emit 5 short beeps and stop searching.

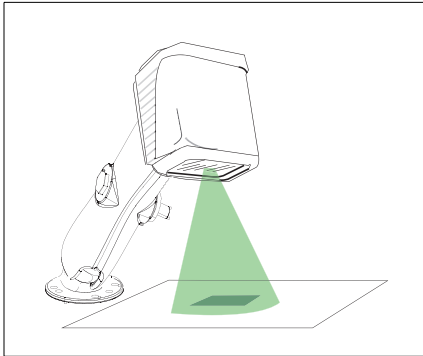

Calibrate by EZ Button

1. Hold down the EZ Button for about two seconds and release when you hear **two short beeps**. The **20%** and **40%** LEDs will illuminate.
2. The imager will search camera settings to determine the best configuration for decoding symbol data.

Note: To end all EZ Button functions, press the EZ Button once and quickly release.

Calibrate by ESP

1. Click the **Calibrate** button.

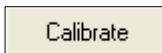

2. The imager will search camera settings to determine the best configuration for decoding symbol data.

A successful calibration will display a green frame around the symbol, and the following message will appear: "Uploading all reader parameters." After a moment the symbol data will be presented in the field below the image display window.

Calibrate by Serial Command

Send **<@CAL>** from a terminal program to begin calibration.

Step 9 — Test Read Rate

Read Rate indicates the number of successful decodes per second achieved by the imager.

Test Read Rate by EZ Button

1. To start the Read Rate test, hold down the EZ Button about three seconds until you hear **three short beeps**. The **20%**, **40%**, and **60%** LEDs will illuminate.

While the symbol is being inspected, the Read Rate LEDs will indicate the corresponding read rate percentage on the back of the unit.

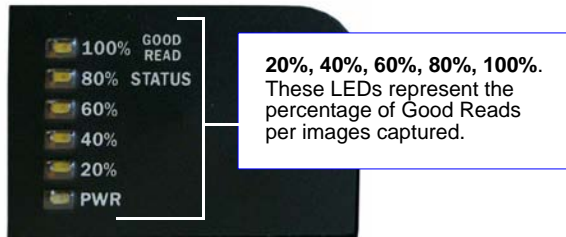

2. To end the Read Rate test, press the EZ Button and quickly release.

Test Read Rate by ESP

1. Click the **Test** button to start the Read Rate test and **Stop** to end it.



If a symbol has been successfully decoded, the symbol's data and related features will be presented in the field below the image display window. Also, while the symbol is being inspected, the Read Rate LEDs will indicate the corresponding Read Rate percentage on the back of the unit.

2. To end the test, click the **Stop** button.

Note: Read Rate can also be tested using the **Read Rate** interface in **Utilities**.

Test Read Rate by Serial Command

You can also start a test with the **<C>** or **<Cp>** command and end it with the **<J>** command.

Step 10 – Configure the Imager in ESP

To make setup changes to Quadrus MINI 3, click the **App Mode** button.



The following modes are accessible by clicking the buttons in the first row of **App Mode** icons:

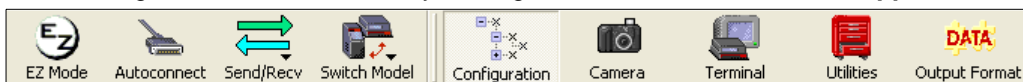

- Click the **Autoconnect** button to establish communications between **ESP** and the imager.
- Click the **Send/Recv** button to send or receive commands.
- Click the **Camera** button to access a live Video view, Evaluate image captures, Calibrate the imager, set the Window of Interest, fine-tune capture settings and processing settings in the Configuration Database, and control multiple read cycle functions in Dynamic Setup.
- Click the **Terminal** button to display decoded symbol data, and to send serial commands to the imager using text or macros.
- Click the **Utilities** button to test Read Rate, request or clear Counters, enable or disable the imager or send output pulses in Device Control, determine the Differences from Default in the current settings, add or remove master symbol data in Master Database, and verify or update the imager's Firmware.
- Click the **Output Format** button to determine the order and content of data output.

Click the **Configuration** button to display the second row of **ESP** icons.

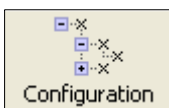

From here you can make changes in the tree controls that can be accessed by clicking the buttons on the second row of icons in the **ESP** window.

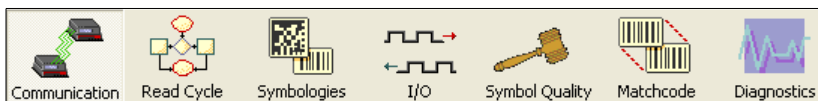

For further details, see **Microscan ESP Help** in the dropdown Help menu.

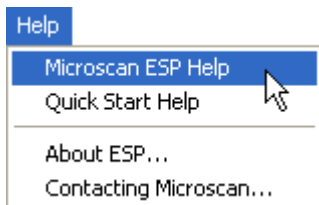

Step 11 — Save Configuration in ESP

To make changes to a configuration setting:

1. **Left-click** on the **+** to expand the desired tree.

2. **Double-click** on the desired parameter and click once in the selection box to view options.

3. Place your cursor in the selection box, scroll down to the setting you want to change, and **click** once on the setting.

4. **Left-click** again on the open screen to complete your selection.

5. **Right-click** on the open screen and select **Save to Reader** to implement the command in the imager.

Parameters	ESP Values
[-] Communications	
[-] RS232/422 Host Port	
[+] Host Port Connections	
[+] Host Protocol	
Host 422 Status	
[+] RS232 Auxilliary Port	
[+] USB HID Report Status	
[+] Preamble	Disabled*
[+] Postamble	Disabled*
Response Timeout	Enabled
LRC Status	Disabled
Aux Port System Data Status	Disabled

Saving Options

- **Send, No Save.** Changes will be lost when power is re-applied to the imager.
- **Send and Save.** This activates all changes in current memory *and* saves to the imager for power-on.

2 Using ESP

Contents

EZ Mode.....	2-2
Application Mode.....	2-3
Menu Toolbar.....	2-4
Autoconnect.....	2-12
View.....	2-14
Navigating in ESP.....	2-15
Send/Receive Options.....	2-16
Using EZ Trax.....	2-18

This section is designed to help you understand the basic structure and elements of **ESP** (Easy Setup Program).

When you open **ESP**, unless otherwise specified in the **ESP Preferences** dialog accessible from the **Options** heading on the menu toolbar, you will enter **EZ Mode** for initial setup. From there, you can enter **Application Mode (App Mode)** and access several configuration menus (**Communications**, **Read Cycle**, **Symbologies**, **I/O Parameters**, **Symbol Quality**, **Matchcode**, and **Diagnostics**), a **Camera** setup interface, a **Terminal** interface, a **Utilities** interface, and an **Output Format** interface.

ESP can be used to configure the Quadrus MINI 3 in three different ways:

- **Tree Controls:** Each configuration menu contains a list of all option settings that pertain to that specific element of imager operation. For example, the **Communications** menu shows a **Host Port Connections** option, and then a list of the sub-options **Baud Rate**, **Parity**, **Stop Bits**, and **Data Bits**. Each of these sub-options is configurable by using dropdown menus.
- **Graphic User Interfaces:** Imager settings can be configured using such point-and-click tools as radio buttons, zoom in/zoom out sliders, spin boxes, check boxes, and drag-and-drop functions.
- **Terminal:** **ESP's Terminal** allows you to send serial configuration and utility commands directly to the imager by typing them in the provided text field.

Information about using **ESP** in specific applications is provided in subsequent sections.

For **ESP** system requirements, see [ESP System Requirements](#) in Chapter 1, [Quick Start](#).

EZ Mode

In **EZ Mode** you are presented with the **Locate**, **Calibrate**, and **Test** options. After connecting to your imager, **EZ Mode** is the screen you will see. You will be provided with on-screen instructions that will help you with positioning, testing, and calibration.

Test

Click the **Test** button to start the Read Rate test for a quick indication of the imager's read capabilities and the limits of your application. When **Decodes per Second** is unchecked, the test will count the percentage of decodes relative to the number of actual scans. Click **Stop** to end the test.

Calibrate

The calibration routine that will optimize the imager by comparing Read Rates at various camera and image processing settings.

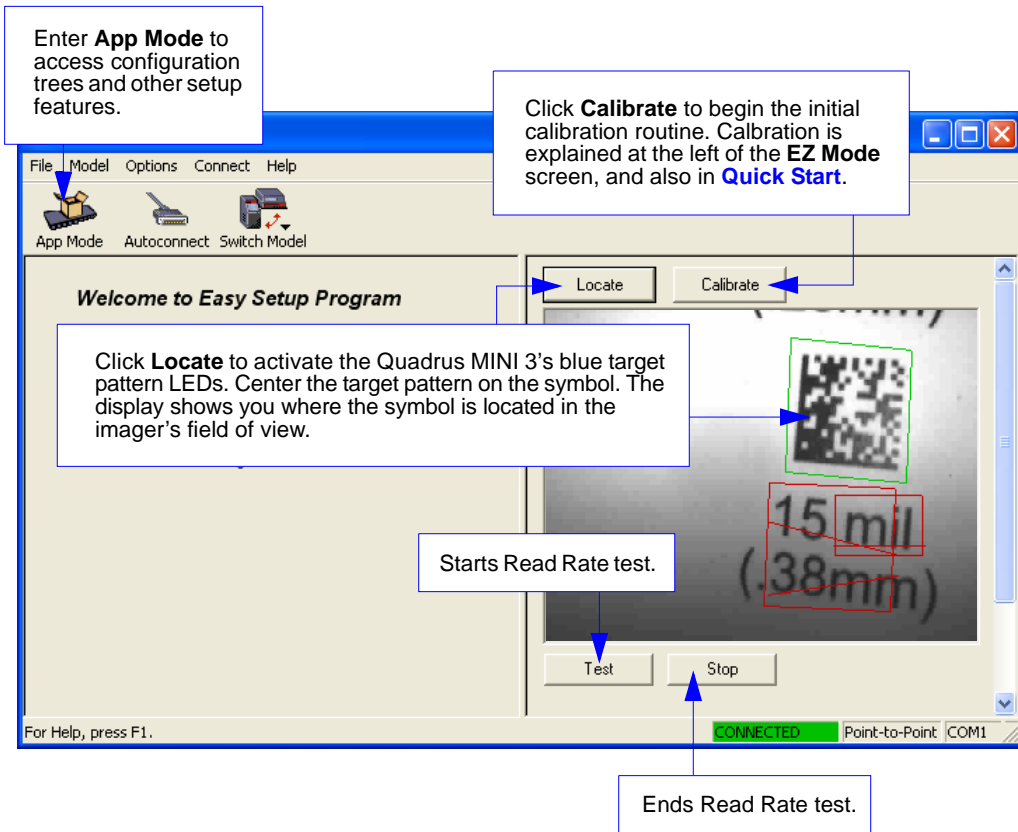

Application Mode

From **EZ Mode**, you can click on the **App Mode** button to access specific configuration menus, **Utilities** tools, **Camera** setup, **Output Format** options, and a **Terminal** window where serial commands can be entered.



Note: The **App Mode** and **EZ Mode** buttons appear in the same position to allow easy switching between these primary modes.

Camera Setup, advanced Calibration, Configuration Database.

Click this icon to return to EZ Mode.

Menu toolbar.

Click here to open the Terminal view.

Click here for Ordered Output and Output Format features.

Click on icons in this row to access configuration trees like the one shown here.

Click the Configuration icon to return to full App Mode view from Camera, Terminal, Utilities, or Output Format.

Click Capture and Decode to read the symbol in the field of view, and to see a high resolution image capture of the symbol.

Decoded symbol data is shown in this table.

ESP - Untitled

File Model Options Connect View Help

EZ Mode Autoconnect Send/Recv Switch Model Configuration Camera Terminal Utilities Output Format

Communication Read Cycle Symbolgies I/O Symbol Quality Matchcode Diagnostics

Parameters

- RS232/422 Host Port
 - Host Port Connections
 - Baud Rate
 - Parity
 - Stop Bits
 - Data Bits
 - Host Protocol
 - Address
 - ACK / NAK Options
 - Polling Mode Options
 - Host 422 Status
- RS232 Auxilliary Port
 - Aux Port Connections
 - Aux Port Settings
- Data Output
- Preamble
- Postamble
- Response Timeout
- LRC Status

One
Eight
Point-to-Point
1
Disabled
Disabled
Enabled
12
Disabled

Capture and Decode

Attribute	Value

For Help, press F1.

CONNECTED

Note: For specific information on any of the icons shown above in the operations bar or configuration bar, see the corresponding chapters in this manual.

Menu Toolbar

File > New

Whenever **New** is selected, the default configuration of **ESP** is loaded.

Open/Save

When **Save** or **Save As** is selected, the **ESP** configuration is saved to the host computer's hard drive and available whenever the same file is selected under **Open**.

Important: When you save menu changes to your hard drive, these changes are not saved to your imager. The illustration below shows how settings can be saved and received between **ESP** and the imager, and **ESP** and the host hard drive.

File	
New	Ctrl+N
Open...	Ctrl+O
Save	Ctrl+S
Save As...	
Print...	Ctrl+P
Import...	
Export...	
Recent File	
Exit	

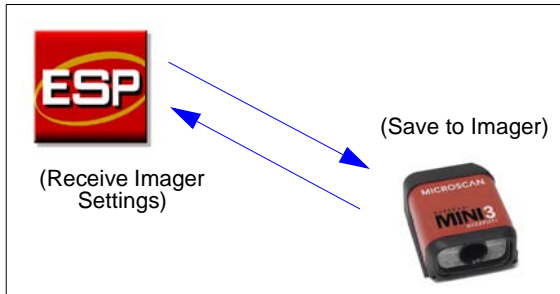

Import/Export

Import converts the ASCII settings from a text file to **ESP** configuration settings.

Export converts the active **ESP** configuration settings to an ASCII text file.

Model

In the **Model** menu you can select any of the models supported by **ESP**. When you choose a different model, the connection to your present model will be terminated.

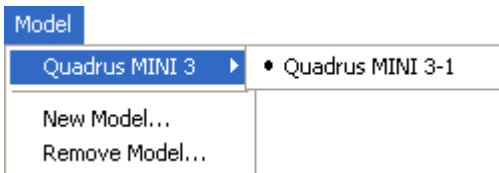

To connect to another model, select **New Model**, choose a new model from the **pop-up menu** that appears, and click **OK**.

Note: When you save an **ESP** file, you are saving the settings of all the models defined in that file.

Options

The **Options** menu allows you to save memos and set up **ESP Preferences**.

Note: Preferences will be saved and loaded into **ESP** whenever **ESP** is opened next, whether or not you save the **ESP** file.

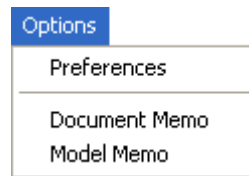

Preferences > General Tab

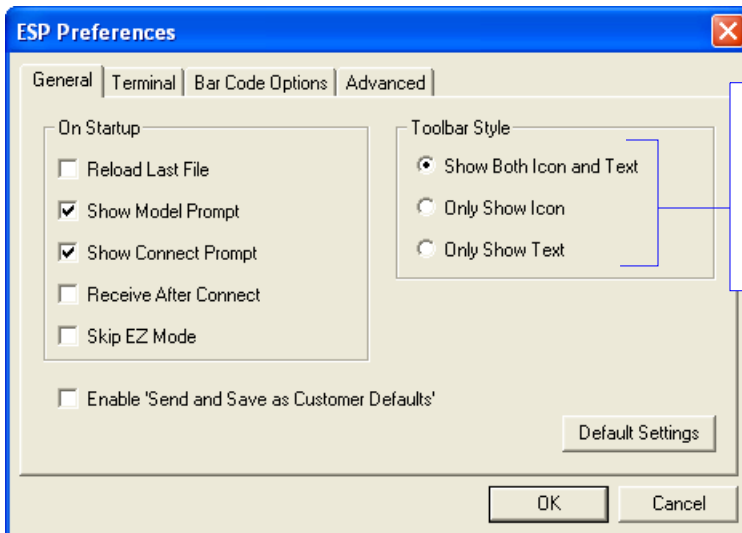

The **Toolbar Style** options allow you to determine how **ESP** will display the mode options in the two rows at the top of the screen.

Reload Last File

At startup, reloads the last file saved to the host computer's hard drive.

Show Model Prompt

At startup, shows the model menu displaying all supported readers.

Show Connect Prompt

At startup, displays the **Would you like to connect to the Quadrus MINI 3?** prompt.

Receive After Connect

At startup, loads the imager's settings into **ESP**. (This is not recommended if you want to preserve your **ESP** settings for future use.)

Skip EZ Mode

At startup, skips **EZ Mode** and opens directly in **App Mode**.

Enable 'Send and Save as Customer Defaults'

At startup, enables the **Send and Save as Customer Defaults** option in the **Send/Recv** command.

Preferences > Terminal Tab

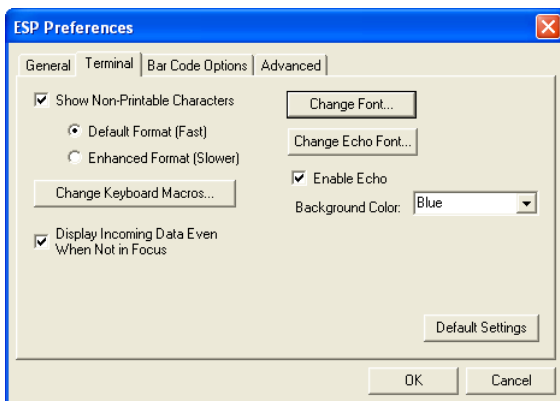

Show Non-Printable Characters

When **Show Non-Printable Characters** is enabled, characters such as “CRLF” will be displayed in the **Terminal** window. When **Enhanced Format** is checked, the characters are displayed with more detailed formatting.

Change Keyboard Macros

Clicking the **Change Keyboard Macros** button brings up the **Function Keys** dialog. In this dialog you can select the desired function key and then enter your macro keystrokes in the associated key map. For example, to make **Ctrl-F2** the keystroke to send a trigger character, select **F2**, then in the **Ctrl** row, enter **<trigger character>** and click **OK**. Then whenever the **Ctrl-F2** keystroke is pressed, the trigger character will start the read cycle.

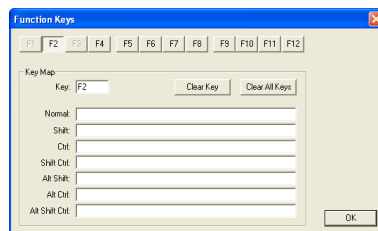

Note: The **F1** key is reserved for opening **ESP Help** and the **F3** key is reserved for the **Find Next** function.

Change Font

Allows you to modify the font used for decode data received from the imager on the **Terminal** screen.

Change Echo Font

Allows you to modify the font used for command characters typed into the **Terminal** view.

Enable Echo

Allows you to enter command characters in **Terminal**.

Display Incoming Data Even When Not in Focus

When **Display Incoming Data Even When Not in Focus** is enabled, data from the imager will continue to appear in the terminal even when **ESP** is not the top window.

Preferences > Bar Code Options Tab

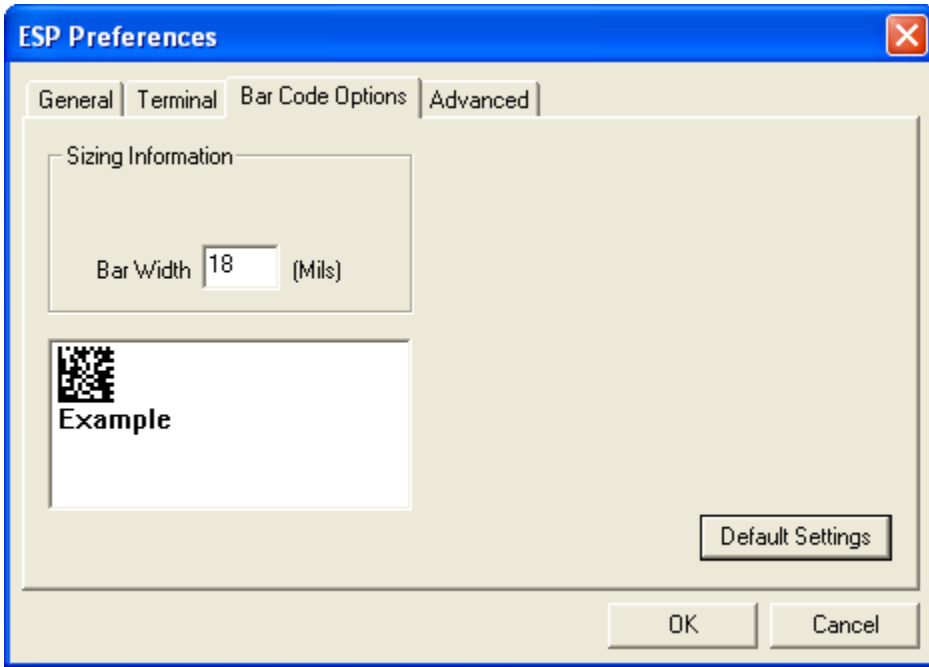

The **Bar Code Options** dialog allows you to set the size of user-created symbols.

Sizing Information

Sets the bar width or module width (in **mils**, or thousandths of an inch) of user-created symbols.

Example: A bar width of 18 is 0.018 inches.

Preferences > Advanced Tab

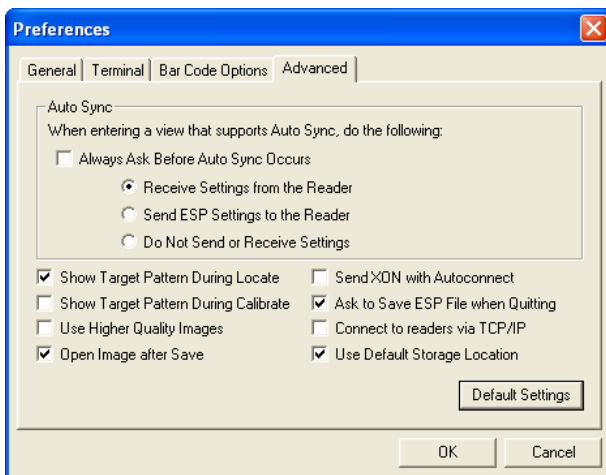

The **Auto Sync** options at the top of the **Advanced** tab allow you to determine whether Auto Sync will be enabled automatically in sections of **ESP** where it is used, or if it will ask you before it enables Auto Sync functions.

Always Ask Before Auto Sync Occurs

If you check this option box, you are then able to determine what specific Auto Sync functions will be enabled. **Receive Settings from the Reader** will automatically send the imager's settings to **ESP** when Auto Sync is enabled. **Send ESP Settings to the Reader** will automatically send all imager configuration settings chosen in **ESP** to the imager. **Do Not Send or Receive Settings** creates a condition in which Auto Sync will not automatically send imager settings to **ESP**, or send **ESP** settings to the imager.

Show Target Pattern During Locate

Allows you to determine whether the blue LED target pattern will be on or off during the **Locate** routine.

Show Target Pattern During Calibrate

Allows you to determine whether the blue LED target pattern will be on or off during the **Calibrate** routine.

Use Higher Quality Images

Sets **ESP** to output images at a higher resolution than standard JPEG format.

Open Image after Save

When **Open Image after Save** is enabled, **ESP** automatically opens saved image captures. Images can be saved from the **Evaluation** tab in the **Camera** view, or by right clicking an image in any other image capture view and then saving.

Send XON with Autoconnect

Sends an **XON (Begin Transmission)** command to the imager before starting the **Autoconnect** routine.

Preferences > Advanced Tab (cont.)

Ask to Save ESP File when Quitting

When enabled, prompts the user to save a **.esp** file when ending a session.

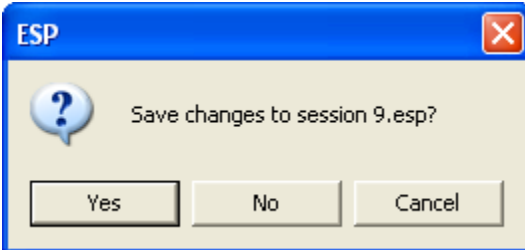

The **.esp** file will be saved in the location of your choice.

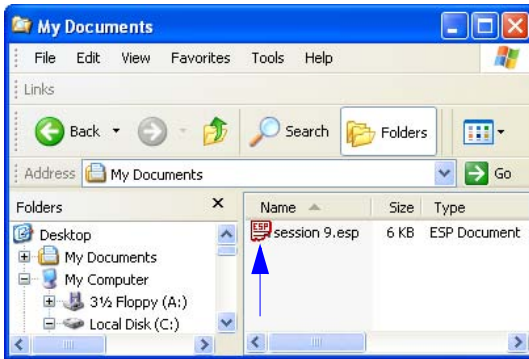

Connect to Readers via TCP/IP

When enabled, shows a **TCP/IP** option on the **Select Protocol** dialog.

Note: This option should only be selected if you intend to connect using an Ethernet adapter.

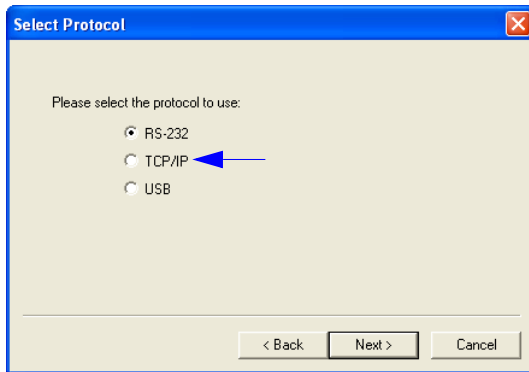

Use Default Storage Location

When enabled, automatically stores data in **ESP's** Application Data folder.

Document Memo

The information you type in the **Document Memo** field will appear in a context-sensitive text box whenever your cursor hovers over the **Document Memo** item on the **Options** menu.

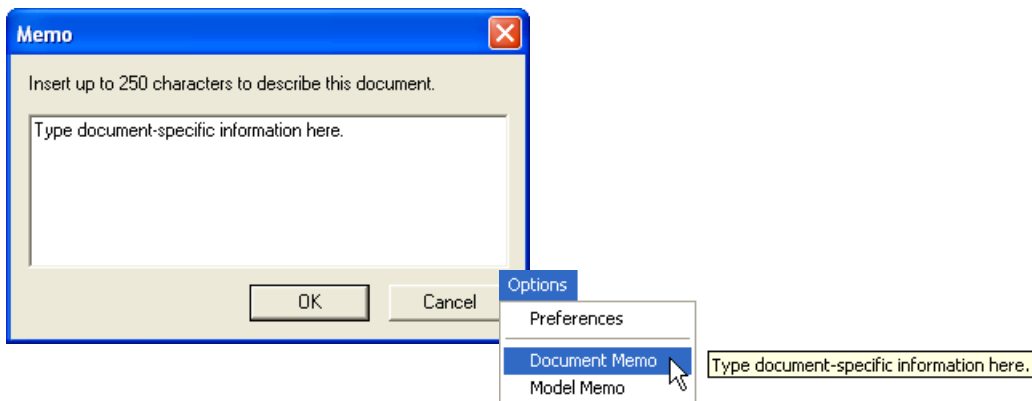

Model Memo

Similar to **Document Memo**, the information you type in the **Model Memo** field will appear in a context-sensitive text box whenever your cursor hovers over the **Model Memo** item on the **Options** menu. Memos created in **Model Memo** are specific to the model enabled when the message was created.

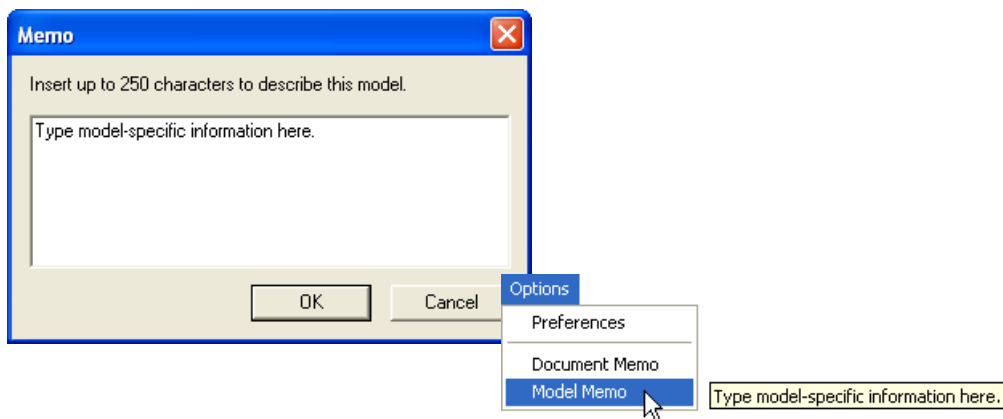

Note: Memos must be saved in a **.esp** file if you want them to be available in your next session. If you do not save your current session, any memos that you have entered during the session will be discarded, and will be unavailable in your next session.

Autoconnect

- If your RS-232 connection attempt fails, you can use **Autoconnect** to establish a connection between the imager and the host.

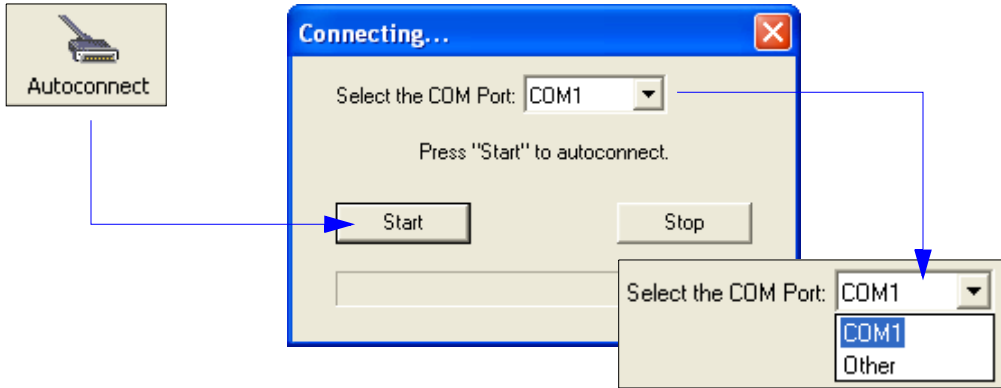

- If your communications port is not the default **COM1**, use the dropdown menu to change your port.

- Once you have chosen the correct port, click **Start** to connect.

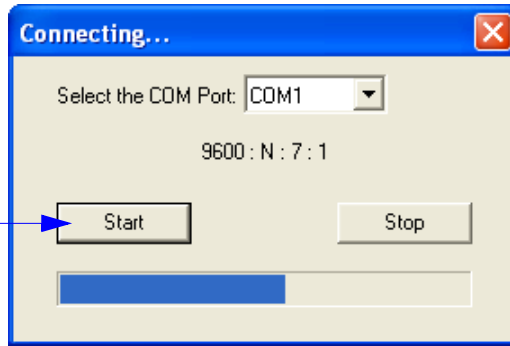

When you are connected, you will see the green connection indicator in the status bar at the bottom right of your screen:

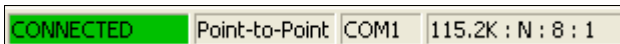

Important: If you are using a **USB** model, you must connect the device to the host computer **before** powering-on. Otherwise the unit will not be recognized as a USB device.

Autoconnect (cont.)

If your RS-232 host settings cannot be changed to match the imager's settings:

- Click **Connect** on **ESP's** menu toolbar, and then select **Connection Wizard**.
- When the **Select Protocol** dialog appears, select **RS-232** and click **Next**.

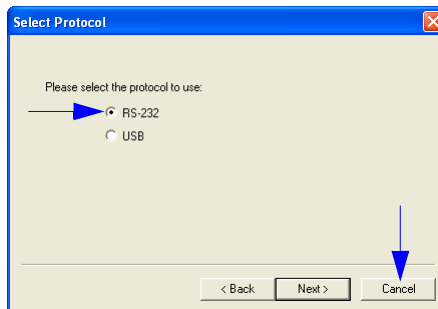

- When the **RS-232** dialog appears, check the **Force Connect** box and click the **Connect** button.

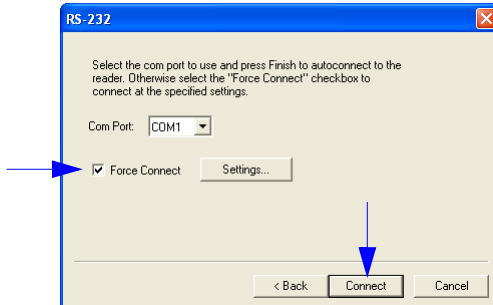

View

The **View** menu allows you to move quickly between interfaces without using the icon buttons on the **App Mode** toolbar. It also allows you to access the **Bar Code Dialog**.

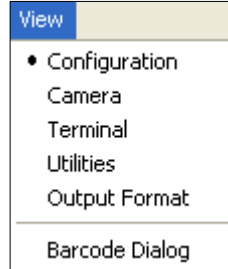

Bar Code Dialog

In the **Bar Code Dialog** you can create symbols by typing the text you wish to encode. This is a useful tool for creating configuration symbols, allowing you to configure your reader by reading the symbols you create.

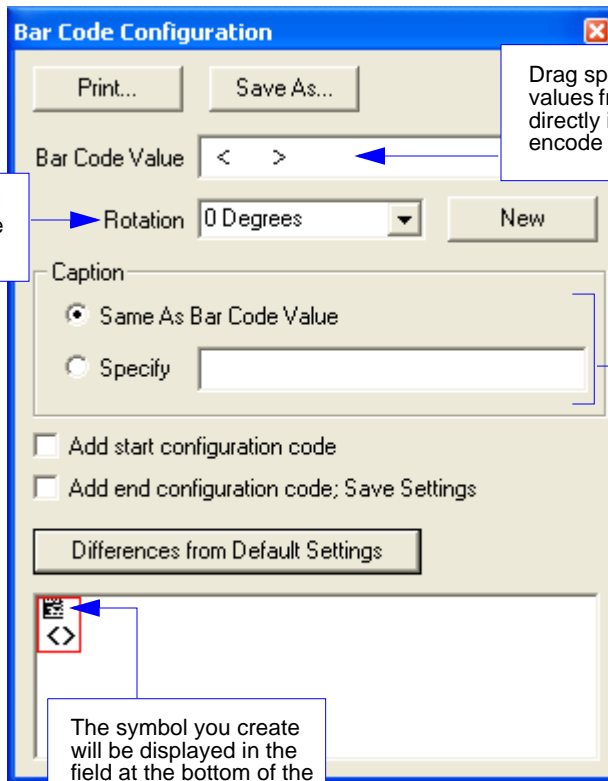

Navigating in ESP

To change imager settings, or to access the **Utilities**, **Camera**, **Terminal**, or **Output Format** views, click the **App Mode** button.



To return to EZ Mode, click the **EZ Mode** button.



To make changes to configuration settings in the tree controls:

1. **Left-click** on the **+** to expand menu items.
2. **Double-click** the desired parameter and **single-click** in the selection box to view options.
3. Place your cursor in the selection box, scroll down to the setting you want to change, and **single-click** the setting.

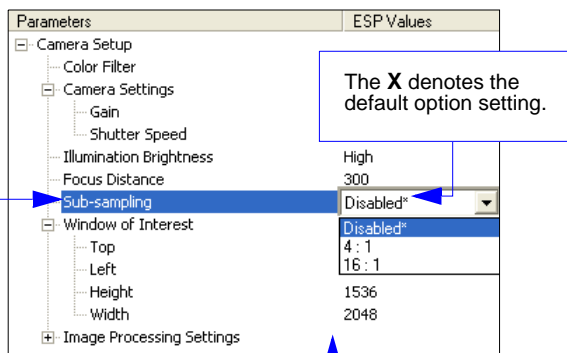

4. **Left-click** again on the open screen to complete the selection.
5. **Right-click** on the open screen and select **Save to Reader** to implement the command in the imager. You can send the command without saving it, or you can send and save the command simultaneously.

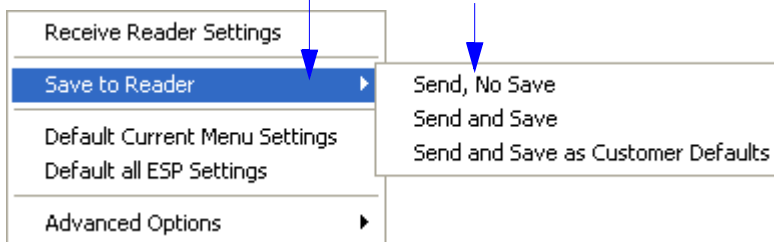

Send/Receive Options

To access **Receive**, **Save**, and **Default** options, click the **Send/Recv** button. You can also access these options by right-clicking in any of the configuration views.



Receiving

From the **Send/Recv** menu, select **Receive Reader Settings**.

Caution: Do not select this option if you do not want to upload the imager's settings. For example, if your **ESP** file has a number of custom settings that you want to maintain and download into the imager, these settings would be lost by choosing **Yes**.

This is useful if you want to receive (upload) the imager's settings and save them as a file for future use. For example, if your imager has settings that you do not want to change, choosing **Yes** would allow you to load those settings to **ESP** and save them in an **ESP** file for later retrieval.

Receiving the imager's settings will also assure that you will not be subsequently saving any unwanted changes that you or someone else has made previously in **ESP**.

Saving

Send, No Save (<A>)

Saves **ESP** settings to current memory.

Send and Save (<Z>)

Activates all changes in current memory *and* saves to the imager for power-on.

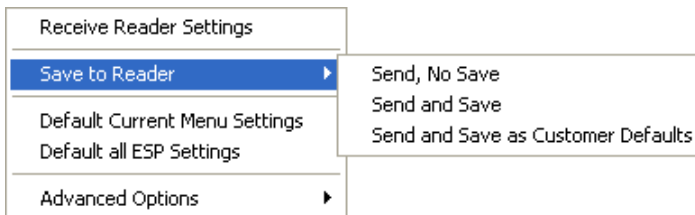

Send and Save as Customer Defaults (<Zc>)

Saves your default settings for quick retrieval.

This option will be visible only if you have checked **Enable 'Send and Save as Customer Defaults'** in **ESP Preferences**.

Defaulting

When you select **Default Current Menu Settings** or **Default all ESP Settings**, you are only defaulting the **ESP** settings.

Advanced Options

Send Current View

This is the same as **Save to Reader** > **Send No Save** except that only the commands in the current configuration tree are sent.

Send Current Command

This is the same as **Send Current View**, except that it saves only the command that is currently selected.

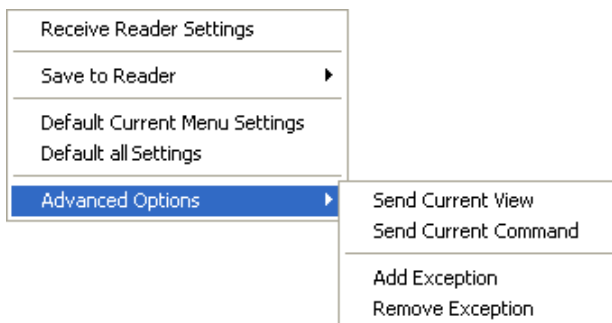

Add/Remove Exception

After you perform a **Receive Reader Settings** command¹ and you click on the **Add Exception** option, you may see a list of serial commands. These are commands that may be in your imager's firmware, but not included in, or different from, your current version of **ESP**.

You can edit these commands by double-clicking on them and changing them as needed.

It is important to note that these commands will be saved to your imager whenever you send a **Save to Reader** command, or an **<A>** or a **<Z>** command.

Also, if there is a corresponding **ESP** menu item, the **ESP Value** column for that item will be blank following a **Receive Reader Settings** command.

1. From the **Send/Recv** button or by right-clicking in any blank section of a tree control view.

Using EZ Trax

For detailed information about using **EZ Trax**, refer to the Help menu in EZ Trax software, or the *EZ Trax Quick Start Guide*, available on the Microscan Tools CD.

For information about how to configure the Quadrus MINI 3 for use with **EZ Trax**, see [Setting Up the Imager for EZ Trax](#) in Chapter 5, [Read Cycle](#).

3 Communications

Contents

Communications by ESP	3-2
Communications Serial Commands.....	3-3
Host Port Connections	3-4
Host Port Protocol.....	3-5
ACK/NAK Options.....	3-7
Polling Mode Options.....	3-8
RS-422 Status.....	3-9
Auxiliary Port Connections.....	3-10
Auxiliary Port System Data Status.....	3-18
Daisy Chain Autoconfigure	3-19
Response Timeout.....	3-20
LRC Status.....	3-21
Protocol Configuration Examples.....	3-22
USB HID Interface	3-23
ASCII Character Entry Modifier.....	3-32
Preamble.....	3-33
Postamble	3-34

This section explains how to set up communications parameters with the host and an auxiliary terminal.

With Microscan's **ESP** (Easy Setup Program), configuration changes can be made in the **ESP** menus and then sent and saved to the imager. The user can also send serial commands to the imager via **ESP**'s **Terminal** window.

Communications by ESP



Click this button to bring up the **App Mode** view.



Click this button to bring up the **Communication** tree control.

Parameters	ESP Values
[-] Communications	
[+] RS232/422 Host Port	
[+] RS232 Auxilliary Port	
[+] USB HID Report Status	
[+] Preamble	Disabled
[+] Postamble	Enabled
[+] Response Timeout	12
[+] LRC Status	Disabled
[+] Aux Port System Data Status	Disabled*
	Disabled*
	Enabled

To open nested options, **single-click** the +.

To change a setting, **double-click** the setting and use your cursor to scroll through the options.

Communications Serial Commands

Host Port Connections	< K100 , <i>baud rate,parity,stop bits,data bits</i> >
Auxiliary Port Connections	< K101 , <i>aux port mode,baud rate,parity,stop bits,data bits,daisy chain ID status,daisy chain ID</i> >
RS-422 Status	< K102 , <i>status</i> >
Host Port Protocol	< K140 , <i>protocol,address</i> >
Preamble	< K141 , <i>status,preamble characters</i> >
Postamble	< K142 , <i>status,postamble characters</i> >
Response Timeout	< K143 , <i>response timeout</i> >
LRC	< K145 , <i>status</i> >
Auxiliary Port System Data Status	< K146 , <i>aux port system data status</i> >
ACK/NAK Options	< K147 , <i>RES,REQ,STX,ETX,ACK,NAK</i> >
Polling Mode Options	< K148 , <i>RES,REQ,STX,ETX,ACK,NAK</i> >
Autoconfiguration Daisy Chain	< K150 <i>DAISY</i> >

Host Port Connections

The host port can be configured with RS-232, RS-422, and RS-485 connections. The following settings define the basic transmission speeds and digital standards that ensure common formatting.

Baud Rate, Host Port

- Usage:** Can be used to transfer data faster or to match host port settings.
- Definition:** The rate at which the reader and host transfer data back and forth.
- Serial Cmd:** <**K100,baud rate,parity,stop bits,data bits**>
- Default:** **115.2K**
- Options:**
- | | | |
|-----------|-----------|-------------------|
| 0 = 600 | 1 = 1200 | 2 = 2400 |
| 3 = 4800 | 4 = 9600 | 5 = 19.2K |
| 6 = 38.4K | 7 = 57.6K | 8 = 115.2K |
| 9 = 230K | | |

Parity, Host Port

- Usage:** Only changed if necessary to match host setting.
- Definition:** An error detection routine in which one data bit per character is set to 1 or 0 so that the total number of bits in the data field is either even or odd.
- Serial Cmd:** <**K100,baud rate,parity,stop bits,data bits**>
- Default:** **None**
- Options:** **0 = None** 1 = Even 2 = Odd

Stop Bits, Host Port

- Usage:** Only changed if necessary to match host setting.
- Definition:** One or two bits added to the end of each character to indicate the end of the character.
- Serial Cmd:** <**K100,baud rate,parity,stop bits,data bits**>
- Default:** **One**
- Options:** **0 = One** 1 = Two

Data Bits, Host Port

- Usage:** Only changed if necessary to match host setting.
- Definition:** One or two bits added to the end of each character to indicate the end of the character.
- Serial Cmd:** <**K100,baud rate,parity,stop bits,data bits**>
- Default:** **Eight**
- Options:** 0 = Seven **1 = Eight**

Note: See [USB HID Interface](#) on page 3-23 for protocol information relating to USB.

Host Port Protocol

Usage: In general, the point-to-point protocols will work well in most applications. They require no address and must use RS-232 or RS-422 communications standards.

Definition: Protocols define the sequence and format in which information is transferred between the reader and the host, or in the case of **Multidrop**, between the readers and a concentrator.

Serial Cmd: **<K140,protocol,address>**

Default: **Point-to-Point**

Options: **0 = Point-to-Point**

1 = Point-to-Point with RTS/CTS

2 = Point-to-Point with XON/XOFF

3 = Point-to-Point with RTS/CTS and XON/XOFF

4 = ACK/NAK

5 = Polling Mode

Note: In all protocol modes, the preamble **<K141>** and postamble **<K142>** character strings can be used to frame the decode data, and both are included in calculating the **LRC** (Longitudinal Redundancy Check).

Point-to-Point (Standard)

Usage: *Used only with RS-232 or RS-422.*

Definition: Standard **Point-to-Point** requires no address and sends the data to the host whenever it is available, without a request or handshake from the host.

Serial Cmd: **<K140,0>**

Point-to-Point with RTS/CTS

Usage: A reader initiates a data transfer with an RTS (request-to-send) transmission. The host, when ready, responds with a CTS (clear-to-send) and the data is transmitted. RTS and CTS signals are transmitted over two dedicated wires as defined in the RS-232 standard. *Used only with RS-232.*

Definition: **Point-to-Point with RTS/CTS** (request-to-send/clear-to-send) is a simple hardware handshake protocol that allows a reader to initiate data transfers to the host.

Serial Cmd: **<K140,1>**

Point-to-Point with XON/XOFF

Usage: If an XOFF has been received from the host, data will not be sent to the host until the host sends an XON. During the XOFF phase, the host is free to carry on other chores and accept data from other devices. *Used only with RS-232.*

Definition: This option enables the host to send the XON and XOFF command as a single byte transmission command of start (^Q) or stop (^S).

Serial Cmd: **<K140,2>**

Point-to-Point with RTS/CTS and XON/XOFF

Usage: Used only with RS-232.

Definition: This option is a combination of **Point-to-Point with RTS/CTS** and **Point-to-Point with XON/XOFF**.

Serial Cmd: <K140,3>

ACK/NAK

Definition: See the **ACK/NAK Options** command <K147> on page 3-7.

Serial Cmd: <K140,4>

Polling Mode

Definition: See the **Polling Mode Options** command <K148> on page 3-8.

Serial Cmd: <K140,5>

Poll Address

Serial Cmd: <K140,protocol,address>

Default: 1

Options: 1 to 50

1 = Poll address 0x1C, Select address 0x1D

2 = Poll address 0x1E, Select address 0x1F

...

50 = Poll address 0x7E, Select address 0x7F

Note: See **USB HID Interface** on page 3-23 for protocol information relating to USB.

ACK/NAK Options

Definition: These parameters take effect for **ACK/NAK <K140,4>** on the main RS-232 or RS-422 ports (not on the Auxiliary Port), and are completely independent of the **Polling Mode Options <K148>**.

The imager always follows the protocol in both directions (to and from the host). There is no option to disable it from either direction.

Serial Cmd: <K147,RES,REQ,STX,ETX,ACK,NAK>

RES-NAK Defaults

<i>RES: (Reset)</i>	00 (disabled)
<i>REQ: (Request)</i>	00 (disabled)
<i>STX: (Start of Text)</i>	00 (disabled)
<i>ETX: (End of Text)</i>	00 (disabled)
<i>ACK: (Acknowledge)</i>	06
<i>NAK: (Negative Acknowledge)</i>	15

The following are general outlines of the **ACK/NAK** protocol. Items that are framed by brackets ([]) can either be disabled or enabled. LRC does not include STX, but it does include preamble, postamble, and ETX.

Symbol Data Output

TX to host: [STX] [preamble] SYMBOL DATA [postamble] [ETX] [LRC]

Response from host: ACK/NAK. Sent when LRC, ETX, postamble, or timeout (waiting for more data) are detected (if REQ is disabled) depending on what is enabled.

Commands from Host to Imager

TX to Imager: [STX] <command> [ETX] [LRC]

Response from Imager: ACK/NAK. Sent when LRC, ETX, or command-ending angle bracket '>' are received, depending on what is enabled.

Command Response from Imager to Host

TX to host: [STX] [preamble] COMMAND RESPONSE DATA [postamble] [ETX] [LRC]

Response from host: ACK/NAK. Sent when LRC, ETX, postamble, command-ending angle bracket '>', or timeout (waiting for more data) are detected, depending on what is enabled.

As with **Polling Mode <K140,5>**, the imager can optionally perform the REQ and RES event sequences in ACK/NAK mode. If the sender does not receive an ACK or NAK, it will send REQ to request such a response (if enabled). When the sender receives an ACK, too many NAKs, or times out (if already enabled), it will send a RES (if enabled) to terminate the transaction.

Note: See [ACK/NAK Data Flow Examples](#) in Appendix D for sample ACK/NAK communication scenarios.

Note: See [USB HID Interface](#) on page 3-23 for protocol information relating to USB.

Polling Mode Options

Definition: These parameters only take effect for **Polling Mode <K140,5>** on the main RS-232 or RS-422 ports (not on the Auxiliary Port), and are completely independent of the **ACK/NAK Options <K147>**.

The values of protocol characters can be changed, but the protocol events cannot be disabled. The polling mode address is configured in the **<K140>** command (see **Poll Address** on page 3-6).

To enable true multidrop protocol, the RS422/485 port must be enabled, **<K102,1>**, in order to turn the transmitter on and off. If RS-232 is enabled instead of RS422/485, **<K102,0>**, then **Polling Mode** will operate as a **Point-to-Point** polling protocol. This is because the RS-232 transmitter is always left on when enabled.

Serial Cmd: **<K148,RES,REQ,STX,ETX,ACK,NAK>**

RES-NAK Defaults

<i>RES: (Reset)</i>	04
<i>REQ: (Request)</i>	05
<i>STX: (Start of Text)</i>	02
<i>ETX: (End of Text)</i>	03
<i>ACK: (Acknowledge)</i>	06
<i>NAK: (Negative Acknowledge)</i>	15

Note: See **Polling Mode Data Flow Examples** in Appendix D for sample **Polling Mode** communication scenarios.

Note: See **USB HID Interface** on page 3-23 for protocol information relating to USB.

RS-422 Status

Usage: RS-232 is an industry standard. RS-422 is used when greater cable lengths are required and/or where noise interference is an issue.

Definition: RS-422, if enabled, allows communication through RS-422 I/O lines.
When RS-422 is enabled, RS-232 is disabled.
When RS-422 is disabled, RS-232 is enabled.

Serial Cmd: <**K102,status**>

Default: **Disabled**

Options: **0 = Disabled** 1 = Enabled

Note: The default setting can only be changed in readers with multiplexed RS-232/RS-422 ports. It is forced to **1** (enabled) in readers with “dedicated” RS-422 ports.

Auxiliary Port Connections

The auxiliary port offers an alternative port that can be configured to communicate by RS-232 in several modes, including daisy chain.

As with the host port parameters, the auxiliary port settings (baud rate, parity, stop bits, and data bits) must be identical with those of the auxiliary device.

Usage: An auxiliary port connects the imager to a remote display or to other readers that can display or transfer data.

Definition: These commands set the communication parameters with the auxiliary port, which can be used to configure menus, send data to the host, display data transmissions originating from the host, and relay data from other imagers set in tandem (daisy chained).

Auxiliary Port Mode

Usage: Can be used to transfer data faster or to match an auxiliary device.

Definition: Determines the flow of data between the auxiliary port device(s), the imager, and the host.

Serial Cmd: <**K101,aux port mode**,baud rate,parity,stop bits,data bits,daisy chain i.d. status, daisy chain i.d.>

Default: **Disabled**

Options: **0 = Disabled** 1 = Transparent 2 = Half duplex
3 = Full duplex 4 = Daisy chain 5 = Command Processing

Baud Rate, Auxiliary Port

Usage: Can be used to transfer data faster or to match an auxiliary device.

Definition: The rate at which the imager and host transfer data back and forth.

Serial Cmd: <**K101,aux port mode**,**baud rate**,parity,stop bits,data bits,daisy chain i.d. status,daisy chain i.d.>

Default: **115.2K**

Options: 0 = 600 1 = 1200 2 = 2400
3 = 4800 4 = 9600 5 = 19.2K
6 = 38.4K 7 = 57.6K **8 = 115.2K**
9 = 230K

Parity, Auxiliary Port

Usage: Only changed if necessary to match host setting.

Definition: An error detection routine in which one data bit in each character is set to 1 or 0 so that the total number of 1 bits in the data field is even or odd.

Serial Cmd: <**K101**,aux port mode,baud rate,**parity**,stop bits,data bits,daisy chain i.d. status,daisy chain i.d.>

Default: **None**

Options: **0 = None** 1 = Even 2 = Odd

Stop Bits, Auxiliary Port

Usage: Only changed if necessary to match host setting.

Definition: Allows the user to select the last one or two bits in each character to indicate the end of the character.

Serial Cmd: <**K101**,aux port mode,baud rate,parity,**stop bits**,data bits,daisy chain i.d. status,daisy chain i.d.>

Default: **One**

Options: **0 = One** 1 = Two

Data Bits, Auxiliary Port

Usage: Only changed if necessary to match host setting.

Definition: Number of bits in each character.

Serial Cmd: <**K101**,aux port mode,baud rate,parity,stop bits,**data bits**,daisy chain i.d. status,daisy chain i.d.>

Default: **Eight**

Options: 0 = Seven **1 = Eight**

Transparent Mode

Usage: A common application, in conjunction with handheld imagers, is one that employs an auxiliary readout to detect misapplied symbols.

Definition: In **Transparent Mode**, data is passed between the auxiliary port and the host. The imager buffers data from the auxiliary port and echoes the keyed data on the auxiliary port.

- Auxiliary port data is passed through to the host whenever a return key is pressed at the auxiliary port or whenever symbol data is sent. If sent with symbol data, it is processed on a first-in/first-out basis.
- Auxiliary port data to the host is always sent with a preamble and postamble.
- If the imager is in a polling mode with the host, auxiliary port data will still pass through.

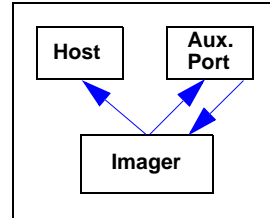

Data Originating from the Imager

- Transmission to the auxiliary port occurs immediately upon a Good Read.
- Data sent to the auxiliary port does not include a preamble or a postamble.
- Communications with the auxiliary port is always in Point-to-Point protocol, even if the host is in a polled protocol mode.

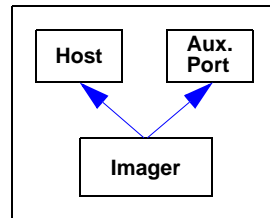

Data Originating from the Host

- All host data is echoed to the auxiliary port in unpolled mode.

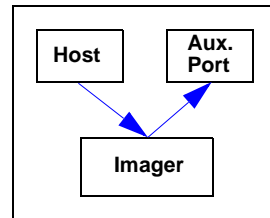

Serial Cmd: <K101,aux port mode,baud rate,parity,stop bits,data bits,daisy chain i.d. status,daisy chain i.d.>

Options: 1 = Transparent

Half Duplex Mode

Usage: Useful when the user wants symbol data displayed on an auxiliary menu close to the imager.

Definition: In **Half Duplex Mode** all auxiliary port data and symbol data is sent directly to the host. Symbol data is displayed on the auxiliary port menu at the same time the data is sent to the host.

Data Originating from the Auxiliary Port

- Auxiliary port data to the host is ignored if the imager is in a polled mode.
- Auxiliary port data or read data is sent to the host whenever it is received.
- Auxiliary port data is not echoed.
- Auxiliary port data to the host is always sent without a preamble or postamble.

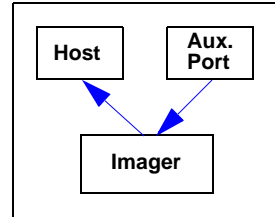

Data Originating from the Imager

- Data is transmitted to the auxiliary port at the same time it is transmitted to the host.
- Data transmission conforms with all parameters specified in the configuration menu (e.g. Preamble, Postamble, End of Read Cycle).

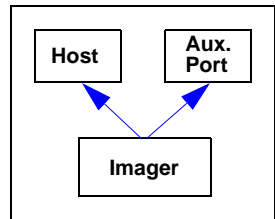

Data Originating from the Host

- All host data is echoed to the auxiliary port in unpolled mode.

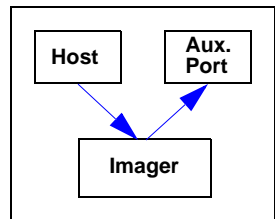

Serial Cmd. **<K101,aux port mode**,baud rate,parity,stop bits,data bits,daisy chain i.d.
status,daisy chain i.d.>

Options: **2 = Half Duplex**

Full Duplex Mode

Usage: When communication to and from the auxiliary port is required.

Definition: In **Full Duplex Mode** all auxiliary port data and symbol data is sent directly to the host. Symbol data is not displayed on the auxiliary port menu.

Data Originating from the Auxiliary Port

- Auxiliary port data to the host is ignored if the imager is in a polled mode.
- Auxiliary port data or read data is sent to the host whenever it is received.
- Auxiliary port data is not echoed.
- Auxiliary port data to the host is always sent without a preamble or postamble.

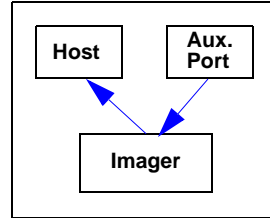

Data Originating from the Imager

- Data is not sent to the auxiliary port.

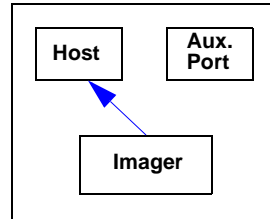

Data Originating from the Host

- All host data is echoed to the auxiliary port in unpolled mode.

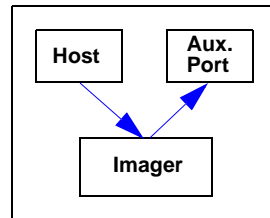

Serial Cmd: <K101,aux port mode,baud rate,parity,stop bits,data bits,daisy chain i.d. status,daisy chain i.d.>

Options: **3 = Full Duplex**

Daisy Chain Mode

Usage: Useful in applications where:

- More than one symbol type is present.
- A symbol may be present on multiple sides of a package.
- Symbols are presented at different depths.

Definition: In a daisy chain application, readers are connected in tandem or a “daisy chain” and decoded data is relayed from one reader to another until the data reaches the host.

A primary reader has its host port linked to the host computer and its auxiliary port linked to the host port of the first *secondary* reader in the chain. Thereafter, each secondary reader’s auxiliary port is linked to the host port of the secondary reader that is farther from the host in the daisy chain. Each reader in the chain can be assigned an ID that accompanies any data that it sends.

Serial Cmd: <**K101,aux port mode**,baud rate,parity,stop bits,data bits,daisy chain i.d. status,daisy chain i.d.>

Options: **4 = Daisy Chain**

Function: Before the primary reader times out, it checks its auxiliary port for data. It should be set to wait at least 30 ms for each secondary reader in the daisy chain. If no data is received within the read cycle timeout, the primary reader sends a No Read message to the host. Otherwise the complete data is sent.

If, for example, the primary reader is set to timeout in 120 ms, the first secondary reader downstream might be set to 90 ms, the next to 30 ms, and so forth, thus assuring that at least 30 ms elapses between transmissions.^a

Daisy-chained readers can send a series of symbols by enabling **Multisymbol** and a common multisymbol separator. If the primary reader does not receive the expected number of symbols, No Read messages are appended to the data string to make up the difference between the number of symbols enabled in **Multisymbol** and the number of symbols read.

For example, a primary and two secondary readers have **Number of Symbols** set to 3 and **Multisymbol Separator** defined as %. If the primary and the first secondary reader do not find symbols, but the next secondary reader registers a Good Read, the transmitted results would be:

```
symbol data % No Read % No Read
```

a. The above example assumes a best-case scenario. Other factors, such as baud rate, number of characters in a given symbol, and the number of secondary readers in the daisy chain can affect timing and may need to be included in your calculations for complete accuracy.

Command Processing Mode

Usage: Allows a user to send configuration settings from the host port to the auxiliary port.

Definition: When enabled, **Command Processing Mode** allows commands to be entered via the auxiliary port and direct externally triggered read cycle data in one of two ways:

- Symbol data, including the serial trigger (if used), will be transmitted to the last port from which a command was sent.
- If the last command came from the host port, then externally triggered read cycle data will only be output to the host port.

Serial Cmd: <**K101,aux port mode**,baud rate,parity,stop bits,data bits,daisy chain i.d.status,daisy chain i.d.>

Options: **5 = Command Processing**

Daisy Chain ID Status

Usage: Used in a daisy chain setup in cases where the host needs to know which reader in the chain sent the data.

Definition: Each reader in a daisy chain can be assigned a one or two character ID that will appear in front of decoded data and identify its source.

Serial Cmd: <**K101**,aux port mode,baud rate,parity,stop bits,data bits,**daisy chain i.d. status**, daisy chain i.d.>

Default: **Disabled**

Options: **0 = Disabled** 1 = Enabled

Note: Enable/disable and length must be the same in all readers.

Daisy Chain ID

Usage: Used in a daisy chain setup in cases where the host needs to know which reader in the chain sent the data.

Definition: A one or two character prefix which identifies the particular daisy chain reader from which the data is being sent to the host.

Serial Cmd: <**K101**,aux port mode,baud rate,parity,stop bits,data bits,**daisy chain i.d. status**,**daisy chain i.d.**>

Default: **1/**

Options: Any one or two ASCII characters.

Important: The ASCII characters <, >, and , can only be entered as hex pairs:

For <: <**K101h,,,,,,,,3C**>

For >: <**K101h,,,,,,,,3E**>

For , : <**K101h,,,,,,,,2C**>

See [ASCII Character Entry Modifier](#) on page 3-32 for a detailed explanation of how to enter ASCII characters as hex values.

Auxiliary Port System Data Status

Definition: When enabled, system data will be routed to the Auxiliary Port. This includes decoded data and diagnostic warning messages.
When disabled, system data will not be routed to the Auxiliary Port.

Serial Cmd: **<K146,aux port system data status>**

Default: **Disabled**

Options: **0 = Disabled** 1 = Enabled

Daisy Chain Autoconfigure

Usage: For quick setup and configuration of your daisy chain network.

Definition: The command to autoconfigure the daisy chain is sent to the primary imager and the software responds in the following ways:

- Counts the number of secondary readers in the daisy chain.
- Assigns an internal ID number (1...n) to each secondary reader, where the first secondary reader is number 1 (the primary reader's ID being a 0).
- Propagates the communications settings and the relevant operating modes of the primary imager to the host and auxiliary ports of each secondary reader.
- Resets each secondary reader.
- Confirms that each secondary reader has acquired the new settings.

Serial Cmd: <**K150DAISY**>

Note: All secondary readers must be set to **Serial** for **Daisy Chain** to function.

When setting up a daisy chain operation, perform the following steps:

1. Set the primary imager (the one connected to the host) to **Serial**.

This sets all the imagers in the chain to **Serial** when the command is executed.

Before **Autoconfigure** you must set the primary imager to **Serial (S)**:

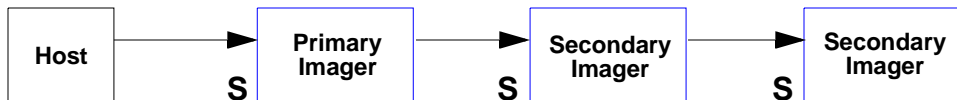

2. Send <**K150DAISY**>.
3. If necessary, set the primary imager to **Edge**.

After **Autoconfigure** you may set the primary imager to **Edge (S)**, but the other imagers must remain in **Serial (S)**:

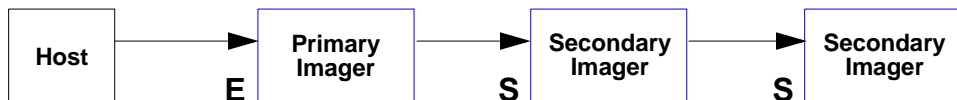

Response Timeout

- Usage:* Only used when a response is required from the host. While in **Multidrop**, if the imager does not receive an **ACK** or **NAK** from the host after sending polled data, it will act on a fault. The reader can be set to wait indefinitely by setting **Response Timeout** to zero.
- Definition:* The time that the imager will wait before timing out if **ACK**, **NAK**, and **ETX** are enabled, and a host response is expected.
- Serial Cmd:* **<K143,response timeout>**
- Default:* **12** (in 1ms increments)
- Options:* 0 to 255 (A zero (0) setting causes an indefinite wait.)

Note: See **USB HID Interface** on page 3-23 for protocol information relating to USB.

LRC Status

(Longitudinal Redundancy Check)

Usage: Used when extra data integrity is required.

Definition: An error-checking routine that verifies the accuracy of transmissions. It is the exclusive OR of all characters following the **STX** (start of text) up to and including the **ETX** (end of text). What this means is that the binary representation of all the characters in a transmission are cumulatively added in a column and each resulting odd integer is assigned a 1 and each even integer a 0 (two 1s = 0, two 0s = 0, a 1 and a 0 = 1). The extra LRC character is then appended to the transmission, and the receiver (usually the host) performs the same addition and compares the results.

Serial Cmd: **<K145,status>**

Default: **Disabled**

Options: **0 = Disabled** 1 = Enabled

Protocol Configuration Examples

Point-to-Point (Main Port)

- <K100,8,0,1,1>** Baud Rate: **115.2K**; Parity: **None**; Stop Bits: **2**; Data Bits: **8**
- <K140,0>** Point-to-Point
- <K102,0>** RS-232 enabled; **<K102,1>** = RS-422 enabled

Polling Mode (Main Port)

- <K100,4,0,1,1>** Baud Rate: **9600**; Parity: **None**; Stop Bits: **2**; Data Bits: **8**
- <K140,5,23>** Polling Mode; Address: **23**
- <K102,0>** RS-232 Point-to-Point polling; **<K102,1>** = RS-422/RS-485 true multidrop (switched transmitter)
- <K143,30>** 30 ms Response Timeout

“User-Defined” Polling Mode (Main Port)

- <K100,4,0,1,1>** Baud Rate: **9600**; Parity: **None**; Stop Bits: **2**; Data Bits: **8**
- <K140,5,12>** Polling Mode; Address: **12**
- <K148,,08,09,18,0B,0C,0D>** Default RES (0x04), REQ=0x08; EOT=0x09; STX=0x18; ETX=0x0B; ACK=0x0C; NAK=0x0D
- <K102,0>** RS-232 Point-to-Point polling; **<K102,1>** = RS-485 (true multidrop with switched transmitter)
- <K143,40>** 40 ms Response Timeout

ACK/NAK (Main Port)

- <K100,9,0,1,1>** Baud Rate: **230K**; Parity: **None**; Stop Bits: **2**; Data Bits: **8**
- <K140,4>** ACK/NAK
- <K147,,,01,1B,2E,1F>** Default RES and REQ (00, disabled); STX=0x01; ETX=0x1B; ACK=0x2E; NAK=0x1F
- <K102,1>** RS-422 enabled; **<K102,0>** = RS-232 enabled
- <K143,50>** 50 ms Response Timeout

Auxiliary Port

Listed below are several examples of Auxiliary Port commands.

- <K101,2,4,0,1,1>** Half Duplex; Baud Rate: **9600**; Parity: **None**; Stop Bits: **2**; Data Bits: **8**
- <K101,1,5,0,1,1>** Transparent; Baud Rate: **19.2K**; Parity: **None**; Stop Bits: **2**; Data Bits: **8**
- <K101,3,7,0,1,1>** Full Duplex; Baud Rate: **57.6K**; Parity: **None**; Stop Bits: **2**; Data Bits: **8**
- <K101,5,6,0,1,1>** Command Processing; Baud Rate: **230K**; Parity: **None**; Stop Bits: **2**; Data Bits: **8**

USB HID Interface

The USB version of the Quadrus MINI 3 operates as an HID (Human Interface Device) on the USB bus. HID-class devices communicate via “report” packets. An HID may support multiple report types, each of which is identified with a unique report ID. The Quadrus MINI 3 supports two different report types:

- **Microscan HID Report** (ID = 1)
- **Keyboard Report** (ID = 2)

The imager always outputs the same data for both report types. The user may enable or disable either report type.

Regardless of the report type used by the host application, the application protocol via USB is identical to RS-232/RS-422 ports. **HID Reports** are used as a channel for standard Microscan imager communication, command input, and symbol data output.

Important: No matter how the imager is configured, it is always able to receive and respond to commands from the host application using **Microscan HID Reports**.

Report Options

The following functionality conditions hold true regardless of how **HID Reports** are configured:

1. The host application must establish a connection with the imager to receive **Microscan HID IN Reports** (symbol data) and to send **Microscan HID OUT Reports** (commands, serial triggers).
2. The imager can always receive **Microscan HID OUT Reports** (commands, serial triggers).
3. The host application can always send commands through **Microscan HID OUT Reports**. If the command requires a response (a part number, for example), the imager will always send the response through **Microscan HID IN Reports**.
4. The imager always ignores **Keyboard OUT Reports** sent by the host operating system.
5. The content of both the **Keyboard Reports** and **Microscan HID IN Reports** is identical, except for **Keyboard Reports** non-printable data limitations.

Microscan HID IN Reports

HID Reports are used as a channel for standard Microscan imager communication, command input, and symbol data output. There are two types of **Microscan HID Reports**:

Report Type

Microscan HID IN (imager to host)

Microscan HID OUT (host to imager)

Data Content

Symbol data; No Reads; Service messages

Commands; serial triggers

Note: The imager is always able to receive commands and serial triggers from the host through **Microscan HID OUT Reports**, regardless of the **Microscan HID IN Report** status. If the imager receives a command that requests a response, such as a part number query, the imager will send a **Microscan HID IN Report** regardless of the **IN Report** status.

Serial Cmd: <K149, **Microscan HID IN Report status**, Keyboard IN Report status>

Default: **1**

Options: 0 = Disabled **1 = Enabled**

Microscan HID IN Reports Enabled

When this feature is enabled, the imager will send **Microscan HID IN Reports** to the host, containing data originated by the imager.

Microscan HID IN Reports Disabled

When this feature is disabled, the imager will *not* send **Microscan HID IN Reports** to the host, containing data originated by the imager.

Keyboard IN Reports

The host operating system will interpret **Keyboard IN Reports** from the imager as if the user were typing keyboard text. The host operating system sends keystrokes to the current application. This is commonly called a **Keyboard Wedge** configuration.

There is one type of **Keyboard Report** used:

Report Type	Data Content
Keyboard IN (imager to host)	Symbol data; No Reads; Service messages

Note: If **Keyboard IN Reports** is enabled, and **Microscan HID IN Reports** is disabled, the read cycle must be **Continuous Read 1 Output**, because there will be no **External Trigger** or **Serial Trigger**. It is not possible to send commands to the imager as **Keyboard OUT Reports**. To send commands to the imager via USB, the host application must establish a connection with the imager and send **Microscan HID OUT Reports**.

Serial Cmd: <**K149**,Microscan HID IN Report status,**Keyboard IN Report status**>

Default: **0**

Options: **0 = Disabled** 1 = Enabled

Keyboard IN Reports Enabled

When this feature is enabled, the imager *will* send **Keyboard IN Reports** to the host, containing data originated by the imager.

Keyboard IN Reports Disabled

When this feature is disabled, the imager will *not* send **Keyboard IN Reports** to the host, containing data originated by the imager.

Microscan HID Report Format

Size: 64 bytes, fixed-length. The **USB HID** standard defines all reports as being fixed-length.

Structure: **REPORT ID (1) LENGTH (1) DATA (62)**

Values in parentheses indicate the size, in bytes, of the field.

Field Descriptions

REPORT ID

Size: 1 byte

Value: 0x01

Note: **Report ID** is the method employed by **USB HID** to allow multiple report formats to be sent and received from the same interface.

LENGTH

Size: 1 byte

Value: 0-62

Note: **Length** indicates the number of valid data bytes in the fixed-length data field. This is necessary because the **USB HID** standards define **HID Reports** as fixed-length, yet the imager or host may require a smaller data size in any given report.

DATA

Size: 62 bytes, fixed-length

Value: 0x00 to 0xFF

Note: The **Data** field is left-justified, meaning it begins immediately after the **Length** field. All unused data space is NUL (00 in hex) padded. Data values can be “binary”, meaning that they span the entire 8 bit range of 0x00 to 0xFF.

Report Format Examples

For clarity, all report format examples are shown as follows: report fields separated by an underscore (_), REPORT ID and LENGTH fields shown as decimal values, data fields shown as printable ASCII characters, and the number of NUL padding bytes shown as decimal values (nn).

IN report (to host)

1_11_A]002374938 (51)

REPORT ID = 1 = Microscan HID

LENGTH = 11

DATA = "A]02374938" = This is a Code 39 symbol.

NUL padding = 51 bytes

OUT report (from host to imager)

1_27_<K200,3><K220,0,300><K714?> (35)

REPORT ID = 1 = Microscan HID

LENGTH = 27

DATA = "<K200,3><K220,0,300><K714?>" = These commands enable External Edge, set a 3 second timeout, and request the No Read configuration command.

NUL padding = 35 bytes

IN report (to host)

1_62_<K714,1, A LONG MESSAGE STREAMED OVER MULTIPLE MICROSCAN HID RE (0)

REPORT ID = 1 = Microscan HID

LENGTH = 62

DATA = "<K714,1, A LONG MESSAGE STREAMED OVER MULTIPLE MICROSCAN HID RE" = This shows the response to the <714?> command. Note that the command status response is not yet complete. See the next report example for the complete response.

NUL padding = 0 bytes

IN report (to host)

1_6_PORTS>(56)

REPORT ID = 1 = Microscan HID

LENGTH = 6

DATA = "PORTS>" = This is the end of the response to the <K714?> command from the previous example.

The entire <K714> command response is as follows:

DATA = "K714,1, A LONG MESSAGE STREAMED OVER MULTIPLE MICROSCAN HID REPORTS>" .

NUL padding = 56 bytes

Keyboard Report Format

Size: 9 bytes, fixed-length.

Structure: **REPORT ID (1) MODIFIER (1) RESERVED (1) KEYCODES (6)**

Values in parentheses indicate the size, in bytes, of the field.

Important: The host application does not need to understand and process **Keyboard Reports**. This task belongs to the host operating system. Keycodes are passed to the host application as if a user were typing keyboard text. The host application must be the active application in order to receive keystrokes.

Keyboard Reports protocol requires that two reports be sent for every keystroke. The first report indicates which key is pressed. The second report indicates “no key pressed”, with all keycodes NUL (00 in hex) to indicate that all keys have been released. In the case of the Quadrus MINI 3, each byte output is equivalent to a keystroke, with a “key pressed” report and a “no key pressed” report. For this reason, data rates are much slower when using **Keyboard Reports**.

Field Descriptions

REPORT ID

Size: 1 byte

Value: 0x02

Note: **Report ID** is the method employed by **USB HID** to allow multiple report formats to be sent and received from the same interface.

MODIFIER

Size: 1 byte

Value: 0x00 to 0xFF

Note: **Modifier** is an 8 bit field, corresponding to the state of the modifier keys at the time the keycode field was generated.

<i>Bit</i>	<i>Key</i>
0	LEFT CTRL
1	LEFT SHIFT
2	LEFT ALT
3	LEFT GUI
4	RIGHT CTRL
5	RIGHT SHIFT
6	RIGHT ALT
7	RIGHT GUI

Field Descriptions

RESERVED

Size: 1 byte

Value: 0x00

Note: This field is **Reserved**. Its value is always NUL (00 in hex).

KEYCODES

Size: 6 bytes

Value: 0x00 to 0xFF

Note: The Quadrus MINI 3 translates 8 bit data values into **Keycode** data in the following ways:

8 Bit Data Value	Keycode Data
0x00 to 0x1F and 0x7F to 0xFF	Decimal key (.) unless otherwise noted.
CR, 0x0D	Enter key
TAB, 0x09	Tab key
ESC, 0x1B	ESC key
“Printable” characters, 0x20 to 0x7E	These all translate to the keystrokes that produce them. This includes a-z, 0-9, punctuation, and SHIFT in the Modifier field, when necessary. Only the first Keycode in the 6 byte array will be populated.

USB HID Configuration Options

The user has the following options for configuring and defaulting a USB version of the Quadrus MINI 3:

Configuration Symbols (Data Matrix with “Configure Reader” Flag)

Symbol configuration can be performed “out-of-the-box”, as the Quadrus MINI 3 is configured for **Continuous Read Mode**, and Data Matrix is enabled by default. Data Matrix symbols are used to encode configuration commands when the symbology’s “configure reader” flag is set.

If the read cycle is changed, or if Data Matrix is disabled, another configuration/default method must be used. This is because the USB Quadrus MINI 3 has no external trigger, unless the user has configured the EZ Button as a trigger.

EZ Button Configuration

By default, basic calibration can be initiated from the EZ Button (3 beeps). Note that this only changes the camera, image processing, and symbology settings of the imager. To default the USB Quadrus MINI 3, hold down the EZ Button during power-on.

Note: This only overwrites Power-On settings with Custom Default settings, as when the **<Zrc>** command is received. It does *not* overwrite Power-On settings with Factory Defaults, as when the **<Zrd>** command is received. If Custom Defaults are misconfigured, another method must be used to default the imager.

Implementing the Host Operating System API and Establishing a Connection with the Microscan HID Interface

When a connection is made, the host can send serial configuration/default commands. The imager will always be able to receive configuration commands from the host application and send responses to those commands. However, the imager can be configured to stop producing IN Reports to the host from symbol data output and diagnostics (service messages).

Configuration Exceptions for USB

Read Cycle Mode

By default, the imager operates in **Continuous Read Mode**. *If the imager is configured using Data Matrix symbols, the read cycle mode should be the last item changed before saving the configuration settings and beginning operation.* This is because all read cycle modes other than **Continuous Read Mode** require a trigger event. In USB, a trigger event can only be initiated by serial command. To send a trigger command the imager, the host application must establish a connection with the imager's **Microscan HID** interface and send the trigger command in a **Microscan HID Report**.

The following read cycle conditions are required for USB Quadrus MINI 3:

Serial Cmd: **<K200,read mode>**

Default: **Continuous**

Options: **0 = Continuous Mode** 1 = Continuous Read 1 Output Mode
 2 = Level Mode 3 = Edge Mode
 4 = Serial Mode 5 = Serial and Edge Mode

Important:

- To use **Level Mode**, you must enable **Undelimited Start Trigger Character <K229>** and **Undelimited End Trigger Character <K230>**.
- To use **Edge Mode**, you must enable and use the **Undelimited Start Trigger Character <K229>**.
- To use **Serial Mode**, you must use the **Delimited Trigger** defined by **<K201>**, or enable and use the **Undelimited Start Trigger Character <K229>**.
- To use **Serial and Edge Mode**, you must use the **Delimited Trigger** defined by **<K201>**, or enable and use the **Undelimited Start Trigger Character <K229>**.

Communications

For the USB version of Quadrus MINI 3, no communications serial commands have any effect on the imager except the following:

- USB HID Report Status **<K149>**
- Preamble **<K141>**
- Postamble **<K142>**

EZ Button

Default on power-on cannot be disabled **<K770,,default> = <K770,,1>**. This ensures a level of safety for recovering from misconfigured Power-On settings **<Z>**. However, it is not foolproof, as defaulting with the EZ Button only recovers Custom Default settings, which can be misconfigured themselves. For this reason, *do not save to Custom Default settings <Zc> until the imager's configuration has been tested.*

Symbologies

If the imager is going to be configured with Data Matrix symbols, do not disable Data Matrix **<K479>**. Disabling Data Matrix will prevent the imager from reading configuration symbols.

ASCII Character Entry Modifier

Commands that require ASCII text fields, such as **Preamble** and **Postamble** commands, can be sent to the imager as hex pairs (see Appendix E, [ASCII Table](#), for conversions).

Serial Cmd Format: **<Knnnh,00-FF>**

To enter ASCII fields as hex values (00 to FF), add a lower-case **h** directly after the command's **K** number, and then enter the hex value that corresponds with the desired ASCII character.

Example:

Consider the **Postamble** command:

Serial Cmd: **<K142,status,postamble character(s)>**

Imagine that your application requires the ASCII character **>** to be the postamble in your symbol decode output.

The ASCII characters **<**, **>**, and **,** can only be entered as hex pairs. So, to make **>** the postamble in your symbol decode output, enter the **Postamble** command as follows:

<K142h,,3E>

Note that the “status” field contains only a **,**. This is because the only field that is being changed is the “postamble character(s)” field. (See [Serial Configuration Command Conventions](#) on page A-11 for a more detailed explanation of this command shortcut.)

Preamble

Preamble Status

Usage: Useful for identifying and controlling incoming data. For example, defining the preamble as a carriage return and a line feed causes each decoded message to be displayed on its own line.

Definition: Defines a one to four character data string that can be added to the front of the decoded data.

Serial Cmd: <**K141,status,preamble character(s)**>

Default: **Disabled**

Options: **0 = Disabled** 1 = Enabled (within any protocol)

Preamble Characters

Serial Cmd: <**K141,status,preamble character(s)**>

Default: **^M** corresponds to: **carriage return**.

Options: To enter control characters within a serial command, hold down the **Ctrl** key while typing the desired character.

Example: <**K141,1,CNTL-m**> to enter the control character **^M**.

Important: The ASCII characters **<**, **>**, and **,** can only be entered as hex pairs:

For **<**: <**K141h,,3C**>

For **>**: <**K141h,,3E**>

For **,**: <**K141h,,2C**>

See [ASCII Character Entry Modifier](#) on page 3-32 for a detailed explanation of how to enter ASCII characters as hex values.

Postamble

Postamble Status

Usage: Useful for identifying and controlling incoming data. For example, defining the postamble as a carriage return and a line feed causes each decoded message to be displayed on its own line.

Definition: Allows the user to enable or disable up to four postamble characters that can be added to the end of the decoded data.

Serial Cmd: <K142,status,postamble character(s)>

Default: **Enabled**

Options: 0 = Disabled **1 = Enabled (within any protocol)**

Postamble Characters

Serial Cmd: <K142,status,postamble character(s)>

Default: **^M^J** corresponds to: **carriage return/line feed**.

Options: To enter control characters within a serial command, hold down the control key while typing the desired character.

Example: <K142,1,CNTL-m CNTL-j> to enter **^M^J**.

Important: The ASCII characters **<**, **>**, and **,** can only be entered as hex pairs:

For **<**: <K142h,,3C>

For **>**: <K142h,,3E>

For **,**: <K142h,,2C>

See [ASCII Character Entry Modifier](#) on page 3-32 for a detailed explanation of how to enter ASCII characters as hex values.



4 Calibration

Contents

Calibration Serial Commands	4-2
Calibration Overview	4-2
Calibration Options	4-3
Calibration by ESP	4-11
Initiating Calibration	4-13
Additional Notes about Calibration.....	4-19

This section shows the Quadrus MINI 3 Imager’s calibration options, and explains the different ways that those options can be configured.

Calibration Serial Commands

Calibration Options	< K529 ,gain,shutter speed,focus position,symbol type,WOI framing,WOI margin,line scan height,processing>
Calibrate	< @CAL >

Calibration Overview

Calibration is one of the most powerful features of the Quadrus MINI 3. The calibration process can be initiated by serial command, EZ Button, or **ESP** user interface.

When the imager enters calibration, it runs through an optimization cycle that sets the ideal parameters for reading symbols at the highest possible level of performance. Calibration can be configured to optimize specific parameters, such as focus, gain, shutter speed, and symbol type.

The calibration process consists of five separate phases: quick focus, search pass, focus pass, medium pass, and fine-tune pass. During this process the imager quickly locates configuration setup, defines a calibration range for the configuration parameters, and then tunes those parameters for optimal performance.

Calibration Options

This command specifies the operation of the imager's calibration feature. The default configuration is set up to perform calibration on gain, focus, and symbol type. The default shutter speed setting is disabled, because not all applications require shutter speed, and when it is required, the application-specific settings tend to vary widely.

Note: **Background Color** (page 6-42) is part of the calibration process regardless of the calibration setup. After successful completion of the calibration routine, the background color will be set to the appropriate value, depending on the symbol in the field of view. The **Mirrored Image** parameter (page 10-27) is not part of the calibration process, and it must be configured appropriately *prior to calibration*.

Gain

Definition: When enabled, gain will be calibrated to provide the best available image quality and performance.

When disabled, gain is fixed and is not part of the calibration process.

Serial Cmd: <K529,gain,shutter speed,focus position,symbol type,WOI framing,WOI margin,line scan height,processing>

Default: **Enabled**

Options: 0 = Disabled **1 = Enabled**

Shutter Speed

Definition: Unless an application is a static setup, the shutter speed setting should be configured by the user based on the application. For dynamic applications, the user should configure the shutter speed setting so the calibration process can optimize the gain for that setting.

Serial Cmd: <K529,gain,shutter speed,focus position,symbol type,WOI framing,WOI margin,line scan height,processing>

Default: **Disabled**

Options: **0 = Disabled** 1 = Enabled

2 = Fast Shutter

Note: The following table shows general guidelines for shutter speed configurations based on various line speeds. The configurations shown depend on the imager's optical configuration, and on symbol element size.

Shutter Speed	Line Speed
0 - 250	static
250 - 750	5" / sec
750 - 1500	10" / sec
1500 - 2000	15" / sec
2000 - 2500	20" / sec

Disabled (Shutter Speed)

When this feature is disabled, the shutter speed is fixed and is not part of the calibration process.

Enabled (Shutter Speed)

When this feature is enabled, shutter speed will be calibrated to provide the best possible image quality and performance.

Fast Shutter

The calibration process will concentrate on achieving the fastest possible shutter setting that will still provide good performance. The image quality or contrast may not be as good as what would be achieved with the **Enabled** setting. The calibration process is not designed to choose the fastest shutter speed that can decode a symbol, but rather to optimize for the fastest shutter speed that still provides good image quality.

Focus Position

Definition: Since focus can be configured by entering the target distance from the imager's parting line, the user will normally configure the focus setting without needing to calibrate. However, if it is necessary to calibrate the focus distance, there are two methods for doing so: the standard "Search Method", or a "Quick Focus" method, both of which are defined below.

Serial Cmd: <K529,gain,shutter speed,**focus position**,symbol type,WOI framing,WOI margin,line scan height,processing>

Default: **Quick Focus**

Options: 0 = Disabled 1 = Enabled

2 = Quick Focus

Disabled

When this feature is disabled, the focus position is fixed and is not part of the calibration process.

Enabled (Search Method)

When this feature is enabled, the focus position will be calibrated to provide the best possible image quality and performance. This method is essentially a search method that attempts to identify the desired focus using a search algorithm that cycles through focus settings to try and locate the desired focus as quickly as possible. This is accomplished when the given symbol in the field of view is decoded. Once a focus distance that will decode the given symbol has been located, the search algorithm will fine-tune the search to locate the "inside" and "outside" focal distances. The final focus distance will be between the "inside" and "outside" values.

Note: This method can be time-consuming if the focus is not found on the first pass.

Quick Focus

Quick Focus is designed to quickly locate the focus setting for an object in the field of view. This is accomplished with minimal processing of the image by analyzing a histogram of the image frame. Before performing the focus calibration, a value for shutter speed and gain is determined and then the calibration process will step through the focus range of the system, capturing the required number of image frames for each focal position. A histogram is performed on each image frame and the histogram results for each focus position are averaged. When this process is completed, the data is analyzed and the optimal focus position is determined.

Note: **Quick Focus** may not work well for all applications. It is not recommended for applications that use very small symbols.

Symbol Type

Serial Cmd: <**K529**,gain,shutter speed,focus position,**symbol type**,WOI framing,WOI margin,line scan height,processing>

Default: **Enabled**

Options: 0 = Disabled **1 = Enabled**

Disabled

When this feature is disabled, only the currently-enabled symbologies will be considered during the calibration process.

Enabled

When this feature is enabled, autodiscrimination will be in effect during the calibration process. All symbologies that are readable by the imager *except PDF417 and Pharmacode* will be considered during calibration. Any new symbologies successfully decoded during calibration will remain enabled at the end of the process. All enabled symbologies will remain enabled.

For example, assume that only Code 39 is enabled at the beginning of calibration. If a Code 128 symbol is read during calibration, then Code 128, as well as Code 39, will be enabled after the calibration process is complete.

Window of Interest (WOI) Framing

Definition: If a WOI framing mode is enabled, it will set the camera WOI to a full-size image when calibration begins. Once a symbol is decoded, the camera WOI will be zoomed-in both vertically and horizontally (regardless of which WOI mode is enabled) to include the symbol plus an additional margin area. This is done to accelerate the calibration process.

When a successful calibration process is completed, the camera WOI will be adjusted according to the mode enabled. Otherwise, the original WOI configuration will be retained.

Serial Cmd: `<K529,gain,shutter speed,focus position,symbol type,WOI framing,WOI margin,line scan height,processing>`

Default: Disabled

Options: **0 = Disabled** 1 = Row and Column
 2 = Row 3 = Column
 4 = Straight Line 5 = Straight Line Framed

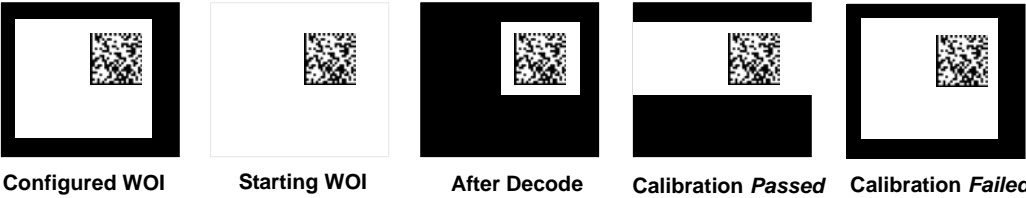

If WOI framing is not enabled, the current WOI configuration will be used until a symbol has been decoded. After a symbol is decoded, the WOI is framed exactly as it would be if a WOI framing mode was enabled. When the calibration process is complete, the original WOI configuration is restored. Refer to the diagram below:

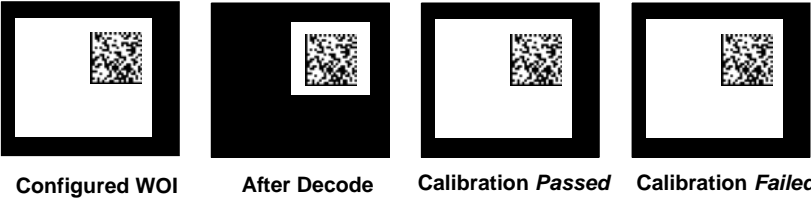

Disabled

When this feature is disabled, the Window of Interest is not modified after the calibration process is complete.

Row and Column

If the calibration process is successful, the Window of Interest will be modified to frame the symbol as well as an additional margin area around the symbol, determined by the **WOI Margin** parameter. Refer to the diagram below:



Column

If the calibration process is successful, the Window of Interest columns will be modified to vertically frame the symbol, plus an additional margin area around the symbol, determined by the **WOI Margin** parameter. Refer to the diagram below:



Row

If the calibration process is successful, the Window of Interest rows will be modified to horizontally frame the symbol, plus an additional margin area around the symbol, determined by the **WOI Margin** parameter. Refer to the diagram below:



Straight Line

This feature is intended for use with linear symbologies. If the calibration process is successful, the orientation of the symbol is determined and the Window of Interest is modified according to the symbol orientation. The scan line orientation is determined to be vertical if the symbol tilt is between 225° and 315°, or between 45° and 135°. Otherwise, the scan line will be horizontal.

If the symbol is vertical, the image column size will be set by the scan height parameter, and will be configured for full row resolution. If the symbol is horizontal, the image row size will be set by the scan height parameter, and will be configured for full column resolution. The scan line will be centered in the middle of the symbol. If the symbol is tilted such that the scan line will not pass completely through the symbol, the scan width will be adjusted to include the entire symbol. Refer to the diagram below:



Straight Line Framed

This parameter is the same as “Straight Line”, except that the Window of Interest will also frame the scan line on the symbol length as well. The scan line includes the symbol plus an additional margin area determined by the **WOI Margin** parameter.

Window of Interest (WOI) Margin

Definition: Sets the margin size that is applied to the calibrated symbol. This parameter is expressed in number of pixels. If the margin causes the image to exceed the maximum image size, it will be reduced accordingly.

Serial Cmd: <K529,gain,shutter speed,focus position,symbol type,WOI framing,**WOI margin**,line scan height,processing>

Default: 75 (pixels)

Options: 20 to 2048

Line Scan Height

Definition: This parameter is only used with the Straight Line modes. It sets the scan height of the straight-line image, and it is expressed in number of pixels.

Serial Cmd: <K529,gain,shutter speed,focus position,symbol type,WOI framing,WOI margin,**line scan height**,processing>

Default: 64 (pixels)

Options: 3 to 1536

Processing

Definition: This setting defines the amount of time and effort the imager will spend attempting to decode a symbol for each parameter configuration.

Serial Cmd: <K529,gain,shutter speed,focus position,symbol type,WOI framing,WOI margin,line scan height,**processing**>

Default: **Medium**

Options: 0 = Low

1 = Medium

2 = High

3 = Definable

Low

The imager will spend a low amount of effort attempting to decode the given symbol for each parameter configuration.

Medium

The imager will spend a medium amount of effort attempting to decode the given symbol for each parameter configuration.

High

The imager will spend a high amount of effort attempting to decode the given symbol for each parameter configuration.

Definable

The processing time for each image frame is defined by the **Image Processing Timeout** parameter <K245>.

Calibration by ESP

ESP's **Calibration** view incorporates all the functionality of the **<K529> (Calibration Options)** command in a single easy-to-use, intuitive interface. This calibration process allows the user much finer control of individual parameters than the calibration routine in **EZ Mode** or on the **Video** tab.

Before/During Calibration

Before and **After** tabs give the user an authentic representation of the difference in what the imager "sees" before and after the calibration routine.

Focus, Shutter, Gain, and Image Quality values are all tracked in real-time during the calibration process.

Gain, Shutter Speed, and Focal Distance (Capture Settings) are all configurable in the **Calibration** interface.

Determines the amount of time and effort the imager will spend attempting to decode a symbol for each parameter configuration. (**Low, Medium, High, Definable**).

Dropdown menu of **1D** and **2D** symbologies, and a check box for enabling or disabling **Composite** symbologies.

Initiates the calibration routine.

Cancels the calibration process, if necessary.

The **Window of Interest** section of the **Calibration** interface allows the user to make precise adjustments to **WOI Framing**, **WOI Margin** (in pixels), and the scan height of the straight-line image (in pixels).

Processing: Medium*

Beginning calibration...

Focus: 240, Shutter: 250, Gain: 32, Quality: 8792

Gain: 32, Shutter Speed: 250, Focal Distance: Quick Focus*

(ECC 200, Code 39)

Composite Enabled

Window of Interest: WOI Framing: Disabled*, WOI Margin: 75, Linescan Height: 64

Buttons: Calibrate, Cancel, Save

After Calibration

The screenshot displays the ESP calibration software interface. At the top left, there are two tabs: 'Before' and 'After'. The 'After' tab is selected, showing a clear image of a barcode. To the right of the image are four vertical indicator bars for Focus (240), Shutter (250), Gain (38), and Quality (8792). Below these bars is a horizontal progress bar that is completely filled with blue. The interface is divided into several sections: 'Capture Settings' with fields for Gain (38), Shutter Speed (250), and Focal Distance (Quick Focus*); 'Symbology Settings' with a dropdown for Symbology Type (ECC 200, Code 39) and a checked 'Composite Enabled' box; and 'Window of Interest' with fields for WOI Framing (Disabled*), WOI Margin (75), and Linescan Height (64). On the right side, there is a 'Processing' dropdown menu set to 'Medium*'. At the bottom right, there are three buttons: 'Calibrate', 'Cancel', and 'Save'. Several callout boxes with blue arrows point to specific elements: one points to the 'After' image, another to the indicator bars, a third to the progress bar, and a fourth to the 'Save' button.

Notice the improved image resolution after the calibration process is complete.

The **Focus, Shutter, Gain, and Quality** indicator bars remain stationary at the end of calibration to provide a visual reference for the final values of these four parameters.

The calibration progress bar indicates that the process has been completed.

Saves the optimal configuration parameters determined by calibration results.

Initiating Calibration

Calibration can be initiated by serial command, the EZ Button, or from the **Calibration** interface in **ESP**.

In **ESP**, the **Calibrate** button starts the calibration routine.

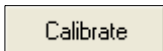

To initiate calibration by serial command, enter the serial command **<@CAL>** from a terminal, such as **ESP's Terminal** interface. **<@CAL>** is a calibration routine that emphasizes contrast and readability.

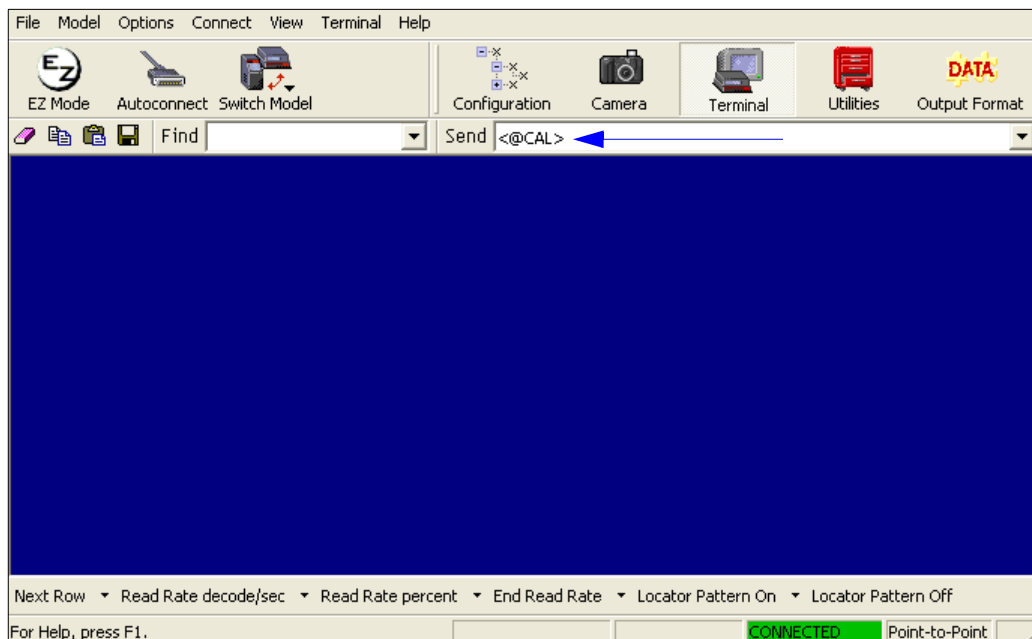

See [Calibrate by EZ Button](#) on page 1-11 for the EZ Button calibration procedure.

Calibration Progress Indicators

During the calibration process, the imager has a number of ways to communicate its progress to the user. The following three types of feedback are the primary ways that the imager communicates calibration progress.

Read Rate LEDs

When calibration is initiated through a serial command or the EZ Button, the imager's Read Rate LEDs indicate calibration progress as follows:

LEDs	Calibration Progress
20%	Search Pass in progress.
20%, 40%	Focus Pass in progress.
20%, 40%, 60%	Medium Pass in progress.
20%, 40%, 60%, 80%	Fine-Tune Pass in progress.
20%, 40%, 60%, 80%, 100%	Calibrated Successfully (holds for green flash duration).



Beeper/Green Flash

The beeper and green LED flash are used to indicate calibration status as shown in the table below:

Indicator	Status
2 quick beeps	Calibration has started.
5 quick beeps	Calibration has failed.
1 long beep	Calibration has been completed successfully.
1 sec. Green Flash	Calibration has been completed successfully.

Calibration Progress Output to Terminal

When initiated by serial command or EZ Button, the calibration operation will output progress and process information to a terminal if the system is configured to do so.

Terminal

Depending upon how the calibration options are configured, the calibration process can have up to 5 steps (Quick Focus, Search Pass, Focus Pass, Medium Pass, Fine-Tune Pass). Calibration data is shown in a simple table format under 8 category headings, each of which are defined below.

Heading	Definition
Prog	Progress indicator with a range of 0 - 100. Indicates percent complete.
Rating	Rating indicator; higher ratings are more favorable.
Decode	Number of successful decodes for the pass.
Quality	Quality indicator; higher ratings are more favorable.
Focus	Focus position under operation.
Shutter	Shutter setting under operation.
Gain	Gain setting under operation.
Locate	Time required to locate symbol, expressed in milliseconds.

Calibration Progress Output Examples (Terminal)

Quick Focus

This mode is only run if **Quick Focus** calibration mode is enabled (see [Focus Position](#) on page 4-5). **Quick Focus** calibration mode is designed to quickly locate the focus setting for an object at the center of the imager's field of view. *There is no terminal output for this operation.*

Search Pass

The purpose of **Search Pass** is to decode a symbol in as few configurations as possible during calibration. This process is designed to quickly identify symbology type, and any image processing parameters that are already calibrated, as well as determining focus position.

Running Search Pass

<i>Prog</i>	<i>Rating</i>	<i>Decode</i>	<i>Quality</i>	<i>Focus</i>	<i>Shutter</i>	<i>Gain</i>	<i>Locate</i>
12	0	0	0	313	250	0	0
14	0	0	0	313	250	9	0
16	0	0	0	313	250	18	0
18	2174	1	72	313	250	27	24

Initiating Calibration

Focus Pass

The purpose of **Focus Pass** is to determine the optimal focal position of the optical system. This is accomplished by determining the inside and outside focus positions and then recording the center position as the desired focal position.

Running Focus Pass

<i>Prog</i>	<i>Rating</i>	<i>Decode</i>	<i>Quality</i>	<i>Focus</i>	<i>Shutter</i>	<i>Gain</i>	<i>Locate</i>
38	0	0	0	353	250	0	0
38	0	0	0	353	250	9	0
38	4256	2	48	353	250	18	5
38	0	0	0	409	250	0	0
38	4236	2	28	409	250	9	5
38	0	0	0	447	250	0	0
38	4236	2	28	447	250	9	4
38	0	0	0	492	250	0	0
38	4232	2	24	492	250	9	4
38	0	0	0	536	250	0	0
38	2128	1	24	536	250	9	5
38	0	0	0	572	250	0	0
38	0	0	0	572	250	9	0
38	2144	1	40	572	250	18	4
38	0	0	0	601	250	27	0
38	0	0	0	601	250	36	0
38	0	0	0	601	250	45	0
38	0	0	0	601	250	45	0
38	0	0	0	601	250	45	0
38	0	0	0	601	250	45	0
42	4280	2	72	297	250	45	6
42	4280	2	72	283	250	45	5
42	4280	2	72	270	250	45	5
42	4280	2	72	258	250	45	5
42	4280	2	72	247	250	45	5
42	4280	2	72	236	250	45	6
42	4280	2	72	227	250	45	5
42	4280	2	72	217	250	45	5
42	4280	2	72	209	250	45	6
42	4280	2	72	200	250	45	6
46	0	0	0	601	250	45	0

Inside Focus = 200; Outside Focus = 572; Center Focus = 386

Medium Pass

The theory behind **Medium Pass** is to develop a readable range from which to dial in a decoded symbol.

Running Medium Pass

<i>Prog</i>	<i>Rating</i>	<i>Decode</i>	<i>Quality</i>	<i>Focus</i>	<i>Shutter</i>	<i>Gain</i>	<i>Locate</i>
51	4216	2	8	386	250	0	5
53	8436	4	20	386	250	4	4
55	6336	3	24	386	250	8	4
57	8448	4	32	386	250	12	4
59	8456	4	40	386	250	16	5
61	8464	4	48	386	250	20	4
63	8472	4	56	386	250	24	5
65	8488	4	72	386	250	28	5
67	8504	4	88	386	250	32	5
69	8512	4	96	386	250	36	5
71	8528	4	112	386	250	40	6
73	8584	4	168	386	250	44	5
75	8644	4	228	386	250	48	5

Rating List (Best):

Rating = 8606; Focus = 386; Shutter = 250; Gain = 48

Rating = 8581; Focus = 386; Shutter = 250; Gain = 44

Rating = 8553; Focus = 386; Shutter = 250; Gain = 40

Rating = 8527; Focus = 386; Shutter = 250; Gain = 36

Rating = 8505; Focus = 386; Shutter = 250; Gain = 32

Rating = 8488; Focus = 386; Shutter = 250; Gain = 28

Rating = 8476; Focus = 386; Shutter = 250; Gain = 24

Initiating Calibration

Fine-Tune Pass

The theory behind **Fine-Tune Pass** is to dial in a decoded symbol based on the range supplied by the **Medium Pass**.

Running Fine Tune Pass

<i>Prog</i>	<i>Rating</i>	<i>Decode</i>	<i>Quality</i>	<i>Focus</i>	<i>Shutter</i>	<i>Gain</i>	<i>Locate</i>
77	6416	3	104	386	250	38	7
79	6424	3	112	386	250	39	6
81	6424	3	112	386	250	40	6
84	6432	3	120	386	250	41	6
86	6448	3	136	386	250	42	5
88	6464	3	152	386	250	43	5
90	6476	3	164	386	250	44	5
93	6488	3	176	386	250	45	5
95	6506	3	194	386	250	46	6
97	6524	3	212	386	250	47	5
100	6538	3	226	386	250	48	6

Rating List (Best):

Rating = 6527; Focus = 386; Shutter = 250; Gain = 48

Rating = 6517; Focus = 386; Shutter = 250; Gain = 47

Rating = 6505; Focus = 386; Shutter = 250; Gain = 46

Rating = 6491; Focus = 386; Shutter = 250; Gain = 45

Rating = 6476; Focus = 386; Shutter = 250; Gain = 44

Rating = 6462; Focus = 386; Shutter = 250; Gain = 43

Rating = 6449; Focus = 386; Shutter = 250; Gain = 42

Calibration PASSED.

Additional Notes about Calibration

The following conditions apply to the imager's calibration process. Some of these items are noted at various points throughout this section, or in other sections of the imager's documentation.

1. The **Mirrored Image** parameter **<K514>** is not part of the calibration process.
2. **Background Color <K451>** is calibrated.
3. If **Window of Interest (WOI) Framing** is enabled, the WOI will be set to full frame when calibration begins. If **WOI Framing** is disabled, the current WOI configuration will be used for the **Search Pass**.
4. **IP Mode <K527>** will not be altered during calibration.
5. **Threshold Mode <K512>** will be set to **Adaptive** during calibration. At the end of a successful calibration, **Threshold Mode** will remain set to **Adaptive** regardless of its previous setting. Otherwise, the value will revert to its original state.
6. If **Symbol Type** is enabled for calibration (**Autodiscriminate**), then **Interleaved 2 of 5 Range Mode Status (Interleaved 2 of 5) <K472>** will be enabled. This allows variable-length Interleaved 2 of 5 symbols to be decoded. If an Interleaved 2 of 5 symbol is decoded during calibration, then code length # 1 will be set to the decoded symbol length at the end of calibration. Otherwise, the symbol lengths will be restored to their original configurations.
7. **Pharmacode** is not calibrated.
8. The symbol size, dimension, and orientation parameters of the **No Symbol Message** and **Bad Symbol Message**, and **2D Symbology Qualification** command **<K718>** will be updated if calibration is completed successfully.
9. All symbol types that were enabled before calibration will still be enabled after calibration. For example, if Data Matrix ECC 200 was enabled before calibration, and the calibration routine was performed on a Code 128 symbol, then after calibration is completed both Data Matrix ECC 200 and Code 128 will be enabled.
10. The calibration process does not modify the global **Composite** status **<K453>**. The global Composite status must be configured properly before calibration.
11. If the user requires calibration of a **stacked** symbology **<K482>**, **<K483>**, or **<K484>**, that symbology must be enabled and configured appropriately before calibration.
12. **UPC Supplementals** will be disabled during calibration.
13. The **Search** process will use the configurable Window of Interest for image captures. However, when the search process is completed, the WOI will be reduced to include only the symbol of interest and some additional boundary area.

5 Read Cycle

Contents

- Read Cycle by ESP 5-2
- Read Cycle Serial Commands..... 5-3
- Read Cycle Setup..... 5-4
- Multisymbol..... 5-5
- Trigger Mode and Filter Duration..... 5-6
- External Trigger Polarity 5-11
- Serial Trigger 5-12
- Start Trigger Character (Non-Delimited)..... 5-13
- Stop Trigger Character (Non-Delimited)..... 5-14
- End of Read Cycle..... 5-15
- Capture Mode..... 5-17
- Capture Timing 5-22
- Image Processing Timeout..... 5-24
- Image Storage 5-25
- Minimum Good Reads 5-27
- Setting Up the Imager for EZ Trax..... 5-28

After you've established communications and completed basic read rate testing, you will need to address the spatial and timing parameters associated with your application. This section explains those parameters.

Read Cycle by ESP



Click this button to bring up the **App Mode** view.

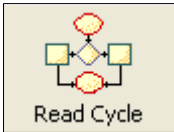

Click this button to bring up the **Read Cycle** tree control.

Parameters	ESP Values
[-] Read Cycle	
[+] Multisymbol	
[+] Trigger	
[+] Serial Trigger	
Decodes Before Output	1
[-] End of Read Cycle	
Mode	Timeout*
Read Cycle Timeout	
[+] Capture Mode	
[+] Capture Time	
[+] Store Noread Image	
[+] Image Processing Settings	

Timeout*

Timeout*

New Trigger

Timeout or New Trigger

Last Frame

Last Frame or New Trigger

To open nested options, **single-click** the +.

To change a setting, **double-click** the setting and use your cursor to scroll through the options.

Read Cycle Serial Commands

Trigger Mode/Filter Duration	< K200 ,trigger mode,leading edge trigger filter,trailing edge trigger filter>
Serial Trigger Character	< K201 ,serial trigger character>
External Trigger State	< K202 ,external trigger state>
End of Read Cycle	< K220 ,end of read cycle,read cycle timeout>
Minimum Good Reads	< K221 ,minimum good reads>
Multisymbol	< K222 ,number of symbols,multisymbol separator>
Start Trigger Character	< K229 ,start character>
Stop Trigger Character	< K230 ,stop character>
Capture Mode	< K241 ,capture mode,number of captures,rapid capture mode,pre-processing>
Capture Timing	< K242 ,time before first capture,time between first and second captures,,,,,,,,,time between seventh and eighth captures>
Image Storage	< K244 ,image storage type,image store mode>
IP Timeout	< K245 ,image processing timeout>

Read Cycle Setup

Setting up read cycle and triggering parameters will involve a series of decisions based on your particular application, as follows:

1. Select the number of symbols to be read in a single cycle. The Quadrus MINI 3 can read multiple symbols in a single image frame.
2. Decide on the trigger type to be used: if serial, choose a serial character; if external, choose either **Level** or **Edge**.
3. Designate how the read cycle should end (**Timeout**, **New Trigger**, **Last Frame**).
4. Select **Capture Mode**, **Continuous Mode**, or **Rapid Mode**.
5. Select **Number of Captures** (if in **Rapid Capture Mode**).
6. Set the **Time Before First Capture** and **Time Between Captures**, if any.

Note: The Quadrus MINI 3's sensor has a frame rate of 7 frames per second (based on a full-size 2048 x 1536 image). The frame rate depends on the size of the frame or Window of Interest.

Note: If you need to set up your Quadrus MINI 3 for use with **EZ Trax** software, see [Setting Up the Imager for EZ Trax](#).

Multisymbol

- Usage:** Multisymbol is commonly used in shipping applications where a shipping symbol contains individual symbols for part number, quantity, etc. This feature allows on trigger to pick up all the symbols.
- Definition:** **Multisymbol** allows the user to define up to 100 symbols that can be read in a single read cycle.
- Conditions:** The following conditions apply:
- Each symbol must be different to be read, unless in **Rapid Capture Mode**, configured for “triggered capture”.
 - The maximum number of characters in a read cycle is 3,000 for all symbols.
 - All No Read messages are posted at the end of the data string, unless output filtering is enabled.
 - If more than one symbol is within the field of view at the same time, symbol data may not be displayed in the order of appearance.
 - If **Matchcode Type** is set to **Sequential** or if **Trigger** is set to **Continuous Read 1 Output**, the imager will behave as if **Number of Symbols** were set to **1**, regardless of the user-defined configuration.

Number of Symbols

- Definition:** **Number of Symbols** is the number of different symbols that can be read in a single read cycle.
- Serial Cmd:** `<K222,number of symbols,multisymbol separator>`
- Default:** **1**
- Options:** 1 to 100

Multisymbol Separator

- Usage:** Used to delimit or separate data fields with a user defined character.
- Definition:** Any valid ASCII character, inserted between each symbol read when Multisymbol is set to any number greater than 1.
- Serial Cmd:** `<K222,number of symbols,multisymbol separator>`
- Default:** `,` (comma)
- Options:** Any available ASCII character.

Important: The ASCII characters `<`, `>`, and `,` can only be entered as hex pairs:

For `<`: `<K222h,,3C>`

For `>`: `<K222h,,3E>`

For `,`: `<K222h,,2C>`

See [ASCII Character Entry Modifier](#) on page 3-32 for a more detailed explanation of how to enter ASCII characters as hex values.

Note: If No Read messages are disabled and there are No Reads occurring, separators will only be inserted between symbol data outputs.

Trigger Mode and Filter Duration

Trigger Mode

Definition: The **Trigger** is the event that initiates a read cycle.

Note: When calibrating the imager or testing read rate, the current trigger setting will be disregarded.

Serial Cmd: <K200,trigger mode,leading edge trigger filter,trailing edge trigger filter>

Default: **Continuous Read**

Options: **0 = Continuous Read**

1 = Continuous Read 1 Output

2 = External Level

3 = External Edge

4 = Serial Data

5 = Serial Data and Edge

Continuous Read

Usage: **Continuous Read** is useful in testing symbol readability or reader functions. It is not recommended for normal operations.

Definition: In **Continuous Read**, trigger input options are disabled, the imager is always in the read cycle, and it will attempt to decode and transmit every capture. If a single symbol stays within read range for multiple read cycles, its data will be transmitted repeatedly until it leaves the read range.

The imager sends replies to serial commands that require responses when symbol data is transmitted, or read cycle timeout is enabled and a timeout occurs *and* at least one captured image has been processed. Depending on the combination of enabled symbologies and the Threshold Mode setting, the imager may take longer than the timeout to process a captured image.

Note: **When to Output** and **No Read** options have no affect on **Continuous Read**.

Serial Cmd: <K200,0>

Continuous Read 1 Output

Usage: **Continuous Read 1 Output** can be useful in applications where it is not feasible to use a trigger and all succeeding symbols contain different information. It is also effective in applications where the objects are presented by hand.

Definition: In **Continuous Read 1 Output** the imager self-triggers whenever it decodes a new symbol or a timeout occurs.

If **End of Read Cycle** is set to **Timeout** and the symbol doesn't change, the output is repeated at the end of each timeout period. For example, if **Timeout** is set to one second, the imager sends the symbol data immediately and repeats the output at intervals of one second for as long as it continues to capture the symbol.

If **End of Read Cycle** is set to **New Trigger**, the imager will send the current symbol data immediately, *but only once*. A new symbol appearing in the imager's range will be read and sent immediately, provided it is not identical to the previous symbol.

Serial Cmd: <K200,1>

Caution: In automated environments, **Continuous Read 1 Output** is not recommended because there is typically no reliable way to verify that a symbol was missed.

Note: If **Trigger Mode** is set to **Continuous Read 1 Output**, the imager will behave as if **Number of Symbols** were set to 1, regardless of the user-defined configuration.

External Level

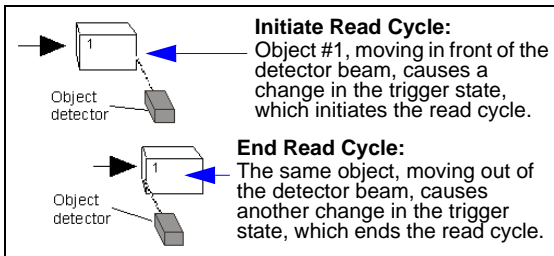

Usage: This mode is effective in an application where the speeds of the conveying apparatus are variable and the time the imager spends reading each object is not predictable. It also allows the user to determine if a No Read has occurred.

Definition: **External Level** allows the read cycle (active state) to begin when a trigger (change of state) from an external sensing device is received. The read cycle persists until the object moves out of the sensor range and the active trigger state changes again.

Serial Cmd: <K200,2>

Important: **Level** and **Edge** apply to the active logic state (**Negative** or **Positive**) that exists while the object is in a read cycle, between the rising edge and the falling edge. *Rising edge* is the trigger signal associated with the appearance of an object. *Falling edge* is the trigger signal associated with the subsequent disappearance of the object. This applies both to **External Level** and **External Edge**.

External Edge

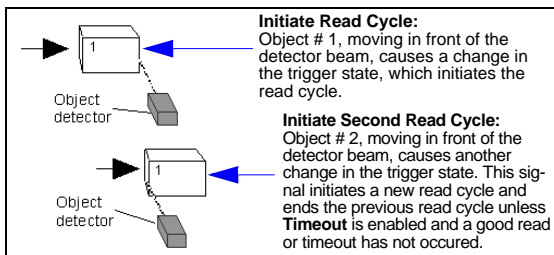

Usage: This mode is highly recommended in any application where conveying speed is constant, or if spacing, object size, or read cycle timeouts are consistent.

Definition: **External Edge**, as with **Level**, allows the read cycle (active state) to begin when a trigger (change of state) from an external sensing device is received. However, the passing of an object out of sensor range does not end the read cycle. The read cycle ends with a good read output, or, depending on the **End of Read Cycle** setting, a timeout or new trigger occurs.

Serial Cmd: <K200,3>

Serial Data

Usage: **Serial Data** is effective in a highly controlled environment where the host knows precisely when the object is in the field of view. It is also useful in determining if a No Read has occurred.

Definition: In **Serial Data**, the imager accepts an ASCII character from the host or controlling device as a trigger to start a read cycle. A **Serial Data** trigger behaves the same as an **External Edge** trigger.

Serial commands are entered inside angle brackets, as shown here: **<t>**.

Serial Cmd: **<K200,4>**

Note: In **Serial Data**, sending a non-delimited start serial character will start a read cycle; however, a non-delimited stop serial character has no effect.

Serial Data and Edge

Usage: **Serial Data and Edge** is seldom used but can be useful in an application that primarily uses an external sensing device but occasionally needs to be triggered manually.

An auxiliary terminal can be connected to the auxiliary port so the user can send the serial trigger character through the imager to the host.

Definition: In this mode the imager accepts either a serial ASCII character or an external trigger pulse to start the read cycle.

Serial Cmd: **<K200,5>**

Note: In **Serial Data**, sending a non-delimited start serial character will start a read cycle; however, a non-delimited stop serial character has no effect.

Leading Edge Trigger Filter

Usage: Used to ignore spurious triggers when **Trigger Mode** is set to External Edge or External Level.

Definition: To consider a change in state on the trigger input, the level must be stable for the trigger filter duration. In an edge mode, the imager will trigger a read cycle if the active state has been uninterrupted for the entire trigger filter duration. In a level mode, the leading edge is filtered such that on an active edge, the state must be held interrupted for the trigger filter duration before a trigger will occur.

Serial Cmd: <**K200**,trigger mode,**leading edge trigger filter**,trailing edge trigger filter>

Default: **313** (~10 ms)

Options: 1 to 65535 (Trigger filter range: 32.0 μ s to 2.10 seconds)

Trailing Edge Trigger Filter

Usage: Used to ignore spurious triggers when **Trigger Mode** is set to External Edge or External Level.

Definition: To consider a change in state on the trigger input, the level must be stable for the trigger filter duration. In an edge mode, the imager will trigger a read cycle if the active state has been uninterrupted for the entire trigger filter duration. In a level mode, the trailing edge is filtered such that on the falling edge, the state must be held for the trigger filter duration before the trigger will be deemed inactive.

Serial Cmd: <**K200**,trigger mode,leading edge trigger filter,**trailing edge trigger filter**>

Default: **313** (~10 ms)

Options: 1 to 65535 (Trigger filter range: 32.0 μ s to 2.10 seconds)

External Trigger Polarity

- Usage:* Allows users to select the trigger polarity that will be used in their application.
- Definition:* Determines the active state of the trigger signal applied to the cable input of the imager.
- Serial Cmd:* <**K202,active state**>
- Default:* **Positive**
- Options:* 0 = Negative **1 = Positive**

Serial Trigger

Usage: Allows the user to define the trigger character and delimiters that start and stop the read cycle.

Definition: A serial trigger is considered an online host command and requires the same command format as all host commands. It must be entered within angle bracket delimiters < > or, in the case of non-delimited triggers, it must define individual start and stop characters.

Serial Trigger Character (Delimited)

Usage: Allows the user to define the trigger character that initiates the read cycle.

Definition: A single ASCII host serial trigger character that initiates the read cycle. A delimited trigger character is one that either starts or ends the read cycle and is enclosed by delimiters such as < >.

Serial Cmd: <**K201,serial trigger character**>

Default: **Space bar**

Options: Any single ASCII character, including control characters, except NUL (00 in hex), an existing host command character, or an on-line protocol character. Control characters entered on the command line are displayed in the menu as mnemonic characters.

Note: **Serial Data** or **Serial Data and Edge** triggering mode must be enabled for **Serial Trigger Character** to take effect.

Important: The ASCII characters <, >, and , can only be entered as hex pairs:

For <: <**K201h,3C**>

For >: <**K201h,3E**>

For , : <**K201h,2C**>

See [ASCII Character Entry Modifier](#) on page 3-32 for a detailed explanation of how to enter ASCII characters as hex values.

Start Trigger Character (Non-Delimited)

Usage: Useful in applications where different characters are required to start a read cycle.

Definition: A single ASCII host serial trigger character that starts the read cycle and is not enclosed by delimiters such as **<** and **>**.

Non-delimited **Start** characters can be defined and will function according to the trigger event.

When defining **Start** trigger characters, the following rules apply:

- In **External Edge** the imager looks only for the **Start** trigger character and ignores any **Stop** trigger character that may be defined.
- In **External Level** the **Start** trigger character begins the read cycle and the **Stop** trigger character ends it. Note that even after a symbol has been decoded and the symbol data transmitted, the imager remains in **External Level** trigger read cycle until a **Stop** character is received.
- In **Serial Data and Edge** trigger mode, either a **Start** trigger character or a hardware trigger can start an edge trigger read cycle.

Serial Cmd: **<K229,start character>**

Default: **NUL** (00 in hex) (disabled)

Options: Two hex digits representing any ASCII character except **XON** and **XOFF**.

Important: The ASCII characters **<**, **>**, and **,** can only be entered as hex pairs:

For **<**: **<K229h,3C>**

For **>**: **<K229h,3E>**

For **,**: **<K229h,2C>**

See [ASCII Character Entry Modifier](#) on page 3-32 for a detailed explanation of how to enter ASCII characters as hex values.

Stop Trigger Character (Non-Delimited)

Usage: Useful in applications where different characters are required to end a read cycle.

Definition: A single ASCII host serial trigger character that ends the read cycle and is not enclosed by delimiters such as < and >. Non-delimited **Stop** characters can be defined and will function according to the trigger event.

When defining **Stop** trigger characters, the following rules apply:

- In **External Edge** the imager looks only for the **Start** trigger character and ignores any **Stop** trigger character that may be defined.
- In **External Level** the **Start** trigger character begins the read cycle and the **Stop** trigger character ends it. Note that even after a symbol has been decoded and the symbol data transmitted, the imager remains in **External Level** trigger read cycle until a **Stop** character is received.
- In **Serial Data and Edge** trigger mode, either a **Start** trigger character or a hardware trigger can start an edge trigger read cycle.

Serial Cmd: <K230,stop character>

Default: **NUL** (00 in hex) (disabled)

Options: Two hex digits representing an ASCII character.

Important: The ASCII characters <, >, and , can only be entered as hex pairs:

For <: <K230h,3C>

For >: <K230h,3E>

For , : <K230h,2C>

See [ASCII Character Entry Modifier](#) on page 3-32 for a detailed explanation of how to enter ASCII characters as hex values.

End of Read Cycle

Definition: The read cycle is the time during which the imager will attempt to capture and decode a symbol. A read cycle can be ended by a timeout, a new trigger, or by the last frame in a capture sequence or a combination of the above.

End of Read Cycle Mode

Note: When operating in Continuous Read or Continuous Read 1 Output, the imager is always in the read cycle.

Serial Cmd: <K220,end of read cycle,read cycle timeout>

Default: **Timeout**

Options: **0 = Timeout**
 1 = New Trigger
 2 = Timeout or new Trigger
 3 = Last Frame
 4 = Last Frame or New Trigger

Timeout

Usage: Typically used with **Serial Data and Edge** and **Continuous Read 1 Output**. It is effective in highly controlled applications when the maximum length of time between objects can be predicted. It assures that a read cycle ends before the next symbol appears, giving the system extra time to decode and transmit the data to the host.

Definition: **Timeout** ends the read cycle, causing the reader to stop reading symbols and send the symbol data or No Read message when the time set in **Timeout** elapses (times out), *if* **When to Output** is set to **End of Read Cycle**.

If in **Continuous Read 1 Output**, a timeout initiates a new read cycle and allows the same symbol to be read again.

With **External Edge**, **Serial Data**, or **Serial Data and Edge** enabled, a timeout ends the read cycle and symbol data or a No Read message is sent to the host.

With **External Level** enabled, the read cycle does not end until the falling edge trigger occurs or a timeout occurs. The next read cycle does not begin until the next rising edge trigger.

New Trigger

Usage: **New Trigger** is an effective way to end a read cycle when objects move past the reader at irregular intervals (not timing-dependent).

Definition: **New Trigger** ends the current read cycle and initiates a new one when a new trigger occurs. **New Trigger** refers only to a rising edge trigger. With **External Edge**, **Serial Data**, or **Serial Data and Edge** enabled, an edge or serial trigger ends a read cycle and initiates the next read cycle. In the case of **External Level**, a falling edge trigger ends the read cycle but the next read cycle does not begin until the occurrence of the next rising edge trigger.

Timeout or New Trigger

Usage: Useful in applications that require an alternative way to end the read cycle. For example, if an assembly line should stop completely or the intervals between objects are highly irregular.

Definition: **Timeout or New Trigger** is identical to **Timeout** except that a timeout or a new trigger (whichever occurs first) ends the read cycle.

Last Frame

Usage: Useful in applications in which the number of captures needed can be defined but the timeout duration varies.

Definition: **Last Frame** only applies to **Rapid Capture Mode**.

Last Frame or New Trigger

Usage: Useful in applications in which line speeds are irregular and a new labelled object could appear before the last frame in a **Rapid Capture** sequence.

Definition: **Last Frame or New Trigger** is identical to **New Trigger** except that a new trigger or last frame (whichever occurs first) ends the read cycle.

Read Cycle Timeout

Definition: **Read Cycle Timeout** is the duration of the read cycle.

Serial Cmd: <**K220**,end of read cycle,**read cycle timeout**>

Default: **200** (x10 ms)

Options: 1 to 65535

Capture Mode

Definition: **Capture Mode** relates to the way that images are captured and processed.

Serial Cmd: `<K241,capture mode,number of captures,rapid capture mode,pre-processing>`

Default: **Continuous Capture**

Options: 0 = Rapid Capture **1 = Continuous Capture**

Rapid Capture

Definition: In a rapid capture mode, one or multiple captures (as many as 32) can be taken at an interval specified by the time-between-captures parameter. In this mode, the only limiting time factor is integration and transfer timing.

Continuous Capture

Usage: **Continuous Capture** is useful in applications with slower line speeds or where symbol spacing may be random or not time-dependent.

Definition: In **Continuous Capture Mode**, image captures are taken throughout the read cycle in a multi-buffered format (see diagram below). The imager begins processing the first captured image at the same time that it captures the second image. Captures will continue occurring throughout the read cycle until an end condition occurs, such as a timeout, a new trigger, the last frame in a capture sequence, or a combination of the above.

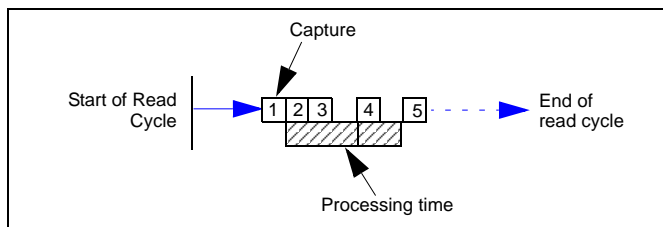

Number of Captures

Usage: **Number of Captures** is used to specify the number of captures to be processed in **Rapid Capture Mode**.

Definition: Sets the total number of captures that are processed during a read cycle in **Rapid Capture Mode**. This feature is used in conjunction with **Capture Timing** parameters to specify the capture sequence of a rapid capture read cycle.

Serial Cmd: <**K241**,capture mode,number of captures,rapid capture mode,pre-processing>

Default: **1**

Options: 1 to 32

Note: The range of maximum number of captures is dynamic. This range is dependent on the maximum image size in the system. A full-size image (2048 x 1536) reduces the maximum number of images to **2**. The smaller the image size, the greater the maximum number of captures. Once the image size is reduced to small enough dimensions, the maximum number of captures will be capped at **32**.

If a user enters a maximum capture value greater than that allowed, the value will be limited to the number of system images. This command also affects the number of stored images allowed in the system. If the maximum number of captures is selected, the number of stored images allowed will be **0**.

Rapid Capture Mode

Definition: In **Rapid Capture Mode**, one or multiple captures (as many as 32) can be taken at an interval specified by the time-between-captures parameter. In this mode, the only limiting time factor is integration and transfer timing.

Serial Cmd: <**K241**,capture mode,number of captures,rapid capture mode,pre-processing>

Default: **Timed Capture**

Options: **0 = Timed Capture** 1 = Triggered Capture

Timed Capture

Usage: **Timed Rapid Capture** is useful in fast-moving applications in which symbols are only in the field of view for a short time and precise timing is required.

Definition: In **Timed Rapid Capture**, decoding occurs independent of and simultaneous with capturing, thus allowing precise timing or no delay at all between captures.

Also, consecutive captures are regarded as the same symbol if the output data is the same.

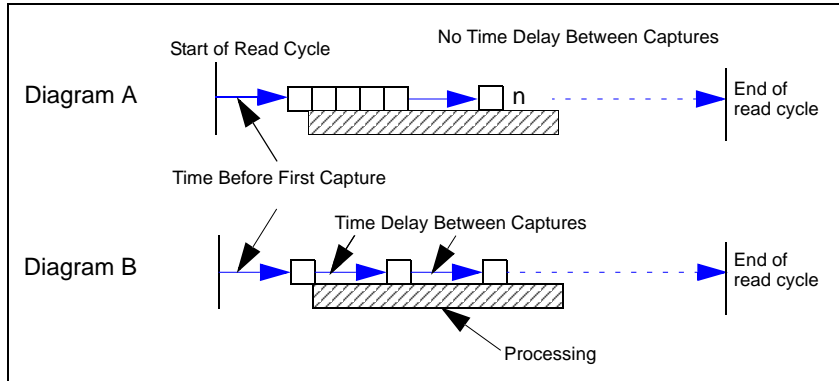

Triggered Capture

Usage: Useful in applications where each decode must be treated as a discrete event, regardless of symbol data.

Definition: The first trigger event starts the read cycle, and subsequent triggers will continue until the predetermined **Number of Captures** is met, or until the predetermined **End of Read Cycle** condition is met—whichever occurs first.

Note: If **End of Read Cycle** is set for **New Trigger** and the read cycle qualifications have not been met, the read cycle will only end once it receives the first trigger after reaching the predetermined **Number of Captures** setting.

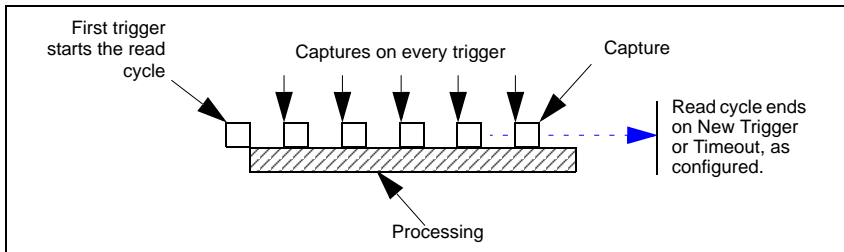

Pre-Processing

Definition: When enabled, this feature reduces the time between image capture and decode by beginning the processing task while an image is being captured.

Serial Cmd: <K241,capture mode,number of captures,rapid capture mode,**pre-processing**>

Default: **Enabled**

Options: 0 = Disabled **1 = Enabled**

Disabled

When **Pre-Processing** is disabled, the imager can process previously captured images while image capture events are taking place. The benefit of this operation is that the image capture events have minimal impact on image processing. Therefore, if the imager is configured to capture 4 consecutive frames, but it is only looking for one decode, it could process and decode a symbol on the first image frame before all 4 image frames were captured. If **Pre-Processing** were enabled, the imager could not start processing an image frame until all 4 image frames were captured (since they are consecutive captures).

Enabled

When **Pre-Processing** is enabled, the imager performs pre-processing tasks while an image is being captured. Since some of the processing is complete when the image has been captured, the time required to complete the processing of the image frame will be less (approx. 10 ms/frame). However, while an image is being captured, the imager is dedicated to operating on the current image being captured. This means that an image capture event will impact the processing time of previously captured image frames. The benefit of this mode is the decrease in capture-to-decode time.

Capture Timing

Note: Capture Timing applies only to **Rapid Capture Mode**.

Time Before First Capture

Usage: In almost any moving line application, a time delay is needed to ensure that a symbol will be in the imager's field of view at the beginning of the capture sequence.

Definition: **Time Before First Capture** in a moving line application is the time between an external trigger event and the occurrence of the first capture.

Serial Cmd: `<K242,time before 1st capture,time between capture 1 and capture 2,,,,,,time between capture 7 and capture 8>`

Default: **0**

Options: 0 to 65535 (2.097 seconds, in 32 μ S increments)

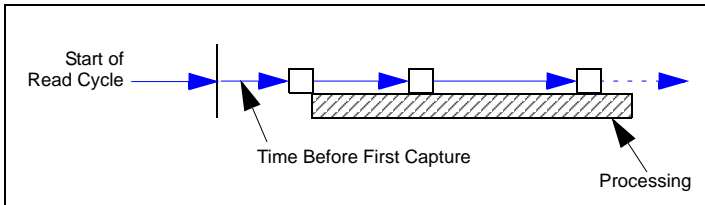

Time Between Captures

Usage: This is useful in applications where more than one symbol can appear during a single read cycle (multisymbol), or where line speeds are slow enough that captured frames might overlap or miss a symbol.

Definition: A time delay can be inserted between individual frame captures in **Rapid Capture Mode**.

Serial Cmd: `<K242,time before 1st capture,time between captures [time 1,time 2,...time7]`

Entering 0s will result in no time between captures.

Entering a different value in each field will vary the time delays accordingly.

Note: You must enter time values along with comma separators for each field you want to change. If you omit fields, or enter only commas, the fields will remain as previously set.

Important: If the imager is configured to capture more than **8** images, the last (or 8th) delay value will be repeated for the remaining captures.

Default: **0**

Options: 0 to 65535 (2.097 seconds, in 32 μ S increments)

Note: Number of Captures and number of frame delays (**Time Between Captures**) must be the same.

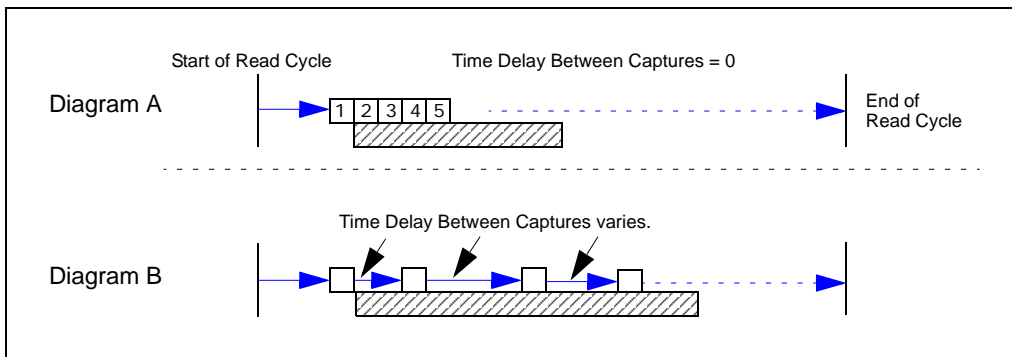

Image Processing Timeout

Usage: Useful in higher speed applications where image processing time is long enough that not all captures have an opportunity to be processed.

Definition: Specifies the maximum amount of time to process a captured image. When the timeout expires, the image processing is aborted. This timeout works in both **Rapid Capture** and **Continuous Capture** modes, as well as with the Configuration Database.

Serial Cmd: **<K245,image processing timeout>**

Default: **5000 ms** (5 sec.)

Options: 1 to 65535 (in 1 ms increments)

Notes:

- The timeout period does not include capture time.
- If a timeout occurs during processing and no symbols in the field of view have been decoded, the image will be recorded as a No Read. For this reason, a longer timeout should be tried to ensure that the symbol is decoded successfully.

Image Storage

Image Storage Type

Definition: Allows the user to store images from separate read cycles and to retrieve them later. The number of available slots for storage depends on the mode of operation. If the imager is in **Rapid Capture Mode**, the number of images that can be stored is equivalent to the maximum number of the rapid count (the current rapid count setting). If the imager is in **Continuous Capture Mode**, a number of images equivalent to the maximum number of the rapid count minus 3.

Serial Cmd: <K244,*image storage type*,*image storage mode*>

Default: **Disabled/Clear**

Options: **0 = Disabled/Clear** 1 = Store on No Read

Disabled/Clear

Upon selection of this option, all saved images will be cleared and the imager will not store images for later viewing.

Store on No Read

This option will cause the imager to store an image upon exiting the read cycle for retrieval at a later time. If multiple captures are present during the duration of a read cycle, the stored image will be the last image processed for that read cycle. This image is stored in RAM and can be retrieved as long as power is cycled to the imager, and as long as the imager has not been reset via a reset/save sequence. Other commands that can initialize storage in RAM are ones that change capture modes or put the imager in a test capture mode.

Image Storage Mode

Serial Cmd: <K244,*image storage type*,*image storage mode*>

Default: **First Mode**

Options: **0 = First Mode** 1 = Last Mode

First Mode

This mode allows the imager to store images until the available image memory has been filled. At that point the imager will stop saving additional images. In this mode, you will always have the first image captured, because the saving process stops once memory has been filled.

Last Mode

In this mode, image storage continues after available memory limits are reached. The oldest image in memory is overwritten, so you will always have the most recent stored image.

Image Storage Example

The following example assumes that the imager is in a rapid capture mode of 3 captures.

Number of Symbols: 1
Frame # 1: No Read
Frame # 2: No Read
Frame # 3: Good Read, Symbol # 1
Read Cycle Result: Good Read
Stored Frame: None

Number of Symbols: 1
Frame # 1: No Read
Frame # 2: No Read
Frame # 3: No Read
Read Cycle Result: No Read
Stored Frame: Frame # 3

Number of Symbols: 2
Frame # 1: No Read
Frame # 2: No Read
Frame # 3: Good Read, Symbol # 1
Read Cycle Result: No Read
Stored Frame: Frame # 2

Minimum Good Reads

- Definition:* This value specifies the number of times a symbol needs to be read to qualify as a good read.
- Serial Cmd:* **<K221,minimum good reads>**
- Default:* **1**
- Options:* 1 to 255

Setting Up the Imager for EZ Trax

If you are using **EZ Trax** software, it is important to set up the Quadrus MINI 3 correctly before beginning.

Click the **Read Cycle** button to display the Read Cycle tree control.

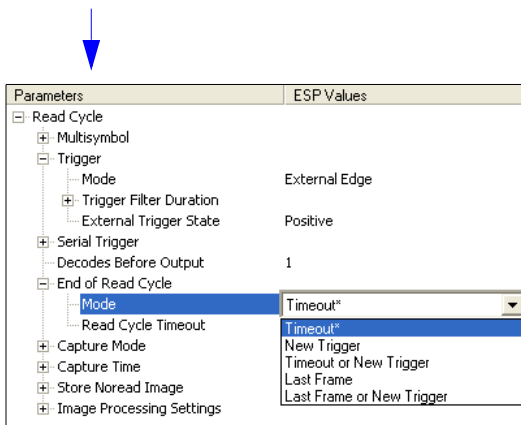
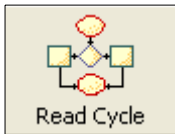

Set **Trigger Mode**, **<K200>**, to **External Edge**.

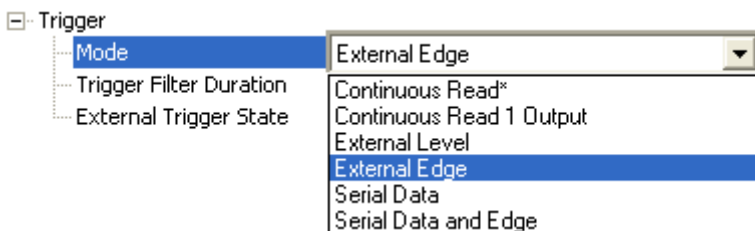

Set **Capture Mode**, **<K241>**, to **Rapid Capture**.

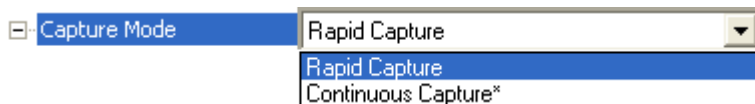

Once these Read Cycle parameters are set, you will be ready to connect to **EZ Trax**. For a description of how to configure **EZ Trax** using serial commands or **ESP**, see [Configuring EZ Trax Output](#) in Chapter 7, [I/O Parameters](#).

For more detailed information about using **EZ Trax**, refer to the Help menu in EZ Trax software, or the *EZ Trax Quick Start Guide*, available on the Microscan Tools CD.



6 Symbologies

Contents

Symbologies by ESP	6-2
Symbologies Serial Commands	6-3
Data Matrix	6-4
Aztec Code	6-6
QR Code	6-7
Micro QR Code.....	6-8
Code 39.....	6-9
Code 128/EAN 128	6-12
BC412	6-15
Interleaved 2 of 5.....	6-16
Code 93.....	6-19
Codabar.....	6-20
UPC/EAN	6-23
Pharmacode	6-27
Postal Symbologies.....	6-29
GS1 DataBar (RSS)	6-34
PDF417	6-36
MicroPDF417	6-38
Composite	6-39
Narrow Margins/Symbology Identifier	6-40
Background Color.....	6-42

This section describes the various symbol types that can be read and decoded by the Quadrus MINI 3.

See the following sites for additional information about linear and 2D symbologies:

<http://www.aimglobal.org/standards/aimpubs.asp>

http://barcodes.gs1us.org/dnn_bcec/Default.aspx?tabid=82

Symbologies by ESP



Click this button to bring up the **App Mode** view.



Click this button to bring up the **Symbologies** tree control.

To open nested options, **single-click** the +.

Parameters	ESP Values
[-] Symbologies	
+ 2D Symbologies	
+ 1D Symbologies	
+ Stacked Symbologies	
+ Composite	Disabled
Narrow Margin Status	Disabled
Symbology Identifier	Disabled
Background Color	White*
	White*
	Black

To change a setting, **double-click** the setting and use your cursor to scroll through the options.

Symbologies Serial Commands

Narrow Margins/Symbology ID	< K450 , <i>narrow margin status,symbology identifier status</i> >
Background Color	< K451 , <i>background color</i> >
Composite	< K453 , <i>symbology status,separator status,separator</i> >
Aztec Code	< K458 , <i>status</i> >
Micro QR Code	< K459 , <i>status</i> >
Postal Symbologies	< K460 , <i>postal symbology type,POSTNET status,PLANET status,USPS4CB status,POSTNET allow B and B' fields,Australia Post allow 0 FCC</i> >
Code 39	< K470 , <i>status,check character status,check character output status,large intercharacter gap,fixed symbol length status,fixed symbol length,full ASCII set</i> >
Codabar	< K471 , <i>status,start/stop match,start/stop output,large intercharacter gap,fixed symbol length status,symbol length,check character type,check character output</i> >
Interleaved 2 of 5	< K472 , <i>status,check character status,check character output status,symbol length #1, symbol length #2, guard bar status,range mode status</i> >
UPC/EAN	< K473 , <i>UPC status,EAN status,supplemental status,separator status,separator character,supplemental type,format UPC-E as UPC-A</i> >
Code 128/EAN 128	< K474 , <i>status,fixed symbol length status,fixed symbol length,EAN 128 status,output format,application record separator status,application record separator character,application record brackets,application record padding</i> >
Code 93	< K475 , <i>status,fixed symbol length status,symbol length</i> >
PDF417	< K476 , <i>status,[unused],fixed symbol length status,fixed symbol length,[unused],codeword collection</i> >
Pharmacode	< K477 , <i>status,fixed bar count status,fixed bar count,minimum bar count,bar width mode,direction,fixed threshold value</i> >
Data Matrix	< K479 , <i>ECC 200 status, ECC 000 status,ECC 050 status, ECC 080 status,ECC 100 status,ECC 140 status,ECC 120 status,ECC 130 status</i> >
QR Code	< K480 , <i>status</i> >
BC412	< K481 , <i>status,check character output,fixed symbol length status, fixed symbol length</i> >
DataBar-14 (RSS-14)	< K482 , <i>status</i> >
DataBar Limited (RSS Limited)	< K483 , <i>status</i> >
DataBar Expanded (RSS Expanded)	< K484 , <i>status,fixed symbol length status,fixed symbol length</i> >
MicroPDF417	< K485 , <i>status,[unused],fixed symbol length status,fixed symbol length</i> >

Data Matrix

Important: If **Q-Mode** is enabled, Data Matrix ECC status is autodiscriminating and all ECC levels are active if *any* of the ECC status fields are set to **Enabled**.

Usage: Very useful where information needs to be packed into a small area, and/or where symbols need to be applied directly to the substrate with laser etching, chemical etching, dot peen, or other methods.

Definition: Data Matrix is a type of Matrix symbology and has subsets ECC 000 - ECC 200. ECC 200 symbols have an even number of rows and an even number of columns. Most of the symbols are square with sizes from 10x10 to 144x144. Some symbols, however, are rectangular, with sizes from 8x18 to 16x48. All ECC 200 symbols can be recognized by the upper right corner module being light (binary 0) instead of dark.

ECC 200

Definition: When enabled, will decode ECC 200 Data Matrix symbols.

Serial Cmd: <**K479,ECC 200 status,ECC 000 status,ECC 050 status,ECC 080 status,ECC 100 status,ECC 140 status,ECC 120 status,ECC 130 status**>

Default: **Enabled**

Note: This is the only symbol type enabled by default.

Options: 0 = Disabled **1 = Enabled**

ECC 000

Definition: When enabled, will decode ECC 000 symbols.

Serial Cmd: <**K479,ECC 200 status,ECC 000 status,ECC 050 status,ECC 080 status,ECC 100 status,ECC 140 status,ECC 120 status,ECC 130 status**>

Default: **Disabled**

Options: **0 = Disabled** 1 = Enabled

ECC 050

Definition: When enabled, will decode ECC 050 symbols.

Serial Cmd: <**K479,ECC 200 status,ECC 000 status,ECC 050 status,ECC 080 status,ECC 100 status,ECC 140 status,ECC 120 status,ECC 130 status**>

Default: **Disabled**

Options: **0 = Disabled** 1 = Enabled

ECC 080

Definition: When enabled, will decode ECC 080 symbols.

Serial Cmd: <**K479**,ECC 200 status,ECC 000 status,ECC 050 status,**ECC 080 status**,
ECC 100 status,ECC 140 status,ECC 120 status,ECC 130 status>

Default: **Disabled**

Options: **0 = Disabled** 1 = Enabled

ECC 100

Definition: When enabled, will decode ECC 100 symbols.

Serial Cmd: <**K479**,ECC 200 status,ECC 000 status,ECC 050 status,ECC 080 status,
ECC 100 status,ECC 140 status,ECC 120 status,ECC 130 status>

Default: **Disabled**

Options: **0 = Disabled** 1 = Enabled

ECC 140

Definition: When enabled, will decode ECC 140 symbols.

Serial Cmd: <**K479**,ECC 200 status,ECC 000 status,ECC 050 status,ECC 080 status,
ECC 100 status,**ECC 140 status**,ECC 120 status,ECC 130 status>

Default: **Disabled**

Options: **0 = Disabled** 1 = Enabled

ECC 120

Definition: When enabled, will decode ECC 120 symbols.

Serial Cmd: <**K479**,ECC 200 status,ECC 000 status,ECC 050 status,ECC 080 status,
ECC 100 status,ECC 140 status,**ECC 120 status**,ECC 130 status>

Default: **Disabled**

Options: **0 = Disabled** 1 = Enabled

ECC 130

Definition: When enabled, will decode ECC 130 symbols.

Serial Cmd: <**K479**,ECC 200 status,ECC 000 status,ECC 050 status,ECC 080 status,
ECC 100 status,ECC 140 status,ECC 120 status,**ECC 130 status**>

Default: **Disabled**

Options: **0 = Disabled** 1 = Enabled

Aztec Code

Note: Aztec Code is only supported when **Q-Mode** is enabled.

Usage: Used in document imaging, railway ticket validation, and some postal applications.

Definition: A 2D matrix symbology built on a square grid with a square “bull’s-eye” pattern at the center. **Aztec Code** can encode up to 3,832 numeric or 3,067 alphabetical characters, or 1,914 bytes of data.

The level of Reed-Solomon error correction used with Aztec Code is configurable, from 5% to 95% of the total data region. The recommended error correction level is 23% of symbol capacity plus codewords.

Serial Cmd: <**K458,status**>

Default: **Disabled**

Options: **0 = Disabled** 1 = Enabled

QR Code

- Usage:* Widely implemented in the automotive industry in Japan and throughout their worldwide supply chain.
- Definition:* QR Code is capable of handling numeric, alphanumeric, and byte data as well as kanji and kana characters. Up to 7,366 characters (numeric data) can be encoded using this symbol. Therefore, less space is required to encode the same amount of data in a QR Code symbol than in a conventional symbol, lowering the cost of labelling.
Three Position Detection Patterns in the symbol make omnidirectional, ultra-fast reading possible.
QR Code has error protection capability. Data can often be restored even if a part of the symbol has become dirty or damaged.
- Serial Cmd:* **<K480,status>**
- Default:* **Disabled**
- Options:* **0 = Disabled** 1 = Enabled

Micro QR Code

Note: Micro QR Code is only supported when **Q-Mode** is enabled.

Usage: Used in various applications that require higher data density than that provided by standard QR Code. Some application examples are automotive inventory, vehicle ID, and mobile phone URL encodation.

Definition: **Micro QR Code** is a 2D matrix symbology that comes in 4 different symbol sizes, the largest capable of encoding 35 numeric characters.

Serial Cmd: **<K459,status>**

Default: **Disabled**

Options: **0 = Disabled** 1 = Enabled

Code 39

- Usage:** **Code 39** is considered the standard for non-retail 1D symbology.
- Definition:** An alphanumeric symbology with unique start/stop code patterns, composed of 9 black and white elements per character, of which 3 are wide.
- Serial Cmd:** *<K470,status,check character status,check character output status,large intercharacter gap,fixed symbol length status,fixed symbol length,full ASCII set>*
- Default:** **Disabled**
- Options:** **0 = Disabled** 1 = Enabled

Check Character Status (Code 39)

- Serial Cmd:** *<K470,status,check character status,check character output status,large intercharacter gap,fixed symbol length status,fixed symbol length,full ASCII set>*
- Default:** **Disabled**
- Options:** **0 = Disabled** 1 = Enabled

Check Character Output Status (Code 39)

- Usage:** **Check Character Output Status**, added to the symbol, provides additional data security.
- Definition:** When enabled, the check character character is read and compared along with the symbol data. When disabled, symbol data is sent without the check character.
- Note:** With **Check Character Output Status** and an **External** or **Serial** trigger option enabled, an invalid check character calculation will cause a No Read message to be transmitted at the end of the read cycle.
- Serial Cmd:** *<K470,status,check character status,check character output status,large intercharacter gap,fixed symbol length status,fixed symbol length,full ASCII set>*
- Default:** **Disabled**
- Options:** **0 = Disabled** 1 = Enabled

Large Intercharacter Gap (Code 39)

Note: Large Intercharacter Gap is not supported when **Q-Mode** is enabled.

Usage: Large Intercharacter Gap is helpful for reading symbols that are printed out of specification.

Important: Do not use Large Intercharacter Gap with Narrow Margins enabled, because a large intercharacter gap (over 3x) could cause a narrow margin (5x) to be interpreted as an intercharacter gap.

Definition: When enabled, the imager can read symbols with gaps between symbol characters that exceed three times (3x) the narrow element width.

Serial Cmd: <K470,status,check character status,check character output status,**large intercharacter gap**,fixed symbol length status,fixed symbol length,full ASCII set>

Default: Disabled

Options: 0 = Disabled 1 = Enabled

Fixed Symbol Length Status (Code 39)

Definition: When enabled, the imager will check the symbol length against the symbol length field. If disabled, any length will be considered valid.

Serial Cmd: <K470,status,check character status,check character output status,**large intercharacter gap**,**fixed symbol length status**,fixed symbol length,full ASCII set>

Default: Disabled

Options: 0 = Disabled 1 = Enabled

Fixed Symbol Length (Code 39)

Usage: Fixed Symbol Length helps prevent truncations and increases data integrity by ensuring that only one symbol length will be accepted.

Definition: Specifies the exact number of characters that the imager will recognize (this does not include start and stop and check character characters). The imager ignores any symbology that does not match the specified length.

Serial Cmd: <K470,status,check character status,check character output status,**large intercharacter gap**,fixed symbol length status,**fixed symbol length**,full ASCII set>

Default: 10

Options: 1 to 64

Full ASCII Set (Code 39)

Usage: Must be enabled when reading characters outside the standard character set (0-9, A-Z, etc.)

The user must know in advance whether or not to use the **Full ASCII Set** option. Since **Full ASCII Set** requires two code words to encode one character, it is less efficient.

Definition: Standard Code 39 encodes 43 characters; zero through nine, capital “A” through capital “Z”, minus symbol, plus symbol, forward slash, space, decimal point, dollar sign, and percent symbol. When **Full ASCII Set** is enabled, the imager can read the full ASCII character set, from 0 to 255.

Serial Cmd: *<K470,status,check character status,check character output status,large intercharacter gap,fixed symbol length status,fixed symbol length,full ASCII set>*

Default: **Disabled**

Options: **0 = Disabled** 1 = Enabled

Code 128/EAN 128

- Usage:** **Code 128** is a smaller symbology useful in applications with tight spots and high security needs.
- Definition:** A very dense alphanumeric symbology. It encodes all 128 ASCII characters, it is continuous, has variable length, and uses multiple element widths measured edge to edge.
- Serial Cmd:** *<K474, status, fixed symbol length status, fixed symbol length, EAN 128 status, output format, application record separator status, application record separator character, application record brackets, application record padding>*
- Default:** **Disabled**
- Options:** **0 = Disabled** 1 = Enabled

Fixed Symbol Length Status (Code 128/EAN 128)

- Definition:** When enabled, the imager will check the symbol length against the symbol length field. If disabled, any length will be considered a valid symbol.
- Serial Cmd:** *<K474, status, fixed symbol length status, fixed symbol length, EAN 128 status, output format, application record separator status, application record separator character, application record brackets, application record padding>*
- Default:** **Disabled**
- Options:** **0 = Disabled** 1 = Enabled

Fixed Symbol Length (Code 128/EAN 128)

- Usage:** **Fixed Symbol Length** helps prevent truncations and increases data integrity by ensuring that only one symbol length will be accepted.
- Definition:** This specifies the exact number of characters that the imager will recognize (this does not include start, stop, and check character characters). The imager ignores any symbol not having the specified length.
- Serial Cmd:** *<K474, status, fixed symbol length status, fixed symbol length, EAN 128 status, output format, application record separator status, application record separator character, application record brackets, application record padding>*
- Default:** **10**
- Options:** 1 to 64

EAN 128 Status (Code 128/EAN 128)

Definition: When this field is disabled, the imager will not check any Code 128 labels for conformance to EAN requirements, or perform any special formatting. When enabled, the imager can read symbols with or without a function 1 character in the first position. If a symbol has a function 1 character in the first position, it must conform to EAN format. Symbols that conform to EAN format will also be subject to the special output formatting options available in this command.

Note: Code 128 status must be enabled for EAN status to be active.

If EAN status is required, the imager will only decode symbols that have a function 1 character in the first position and that conform to EAN format. All symbols read will be subject to the special output formatting options available in this command.

Note: Code 128 status must be enabled for EAN status to be active.

Serial Cmd: <K474,status,fixed symbol length status,fixed symbol length,EAN 128 status,output format,application record separator status,application record separator character,application record brackets,application record padding>

Default: Disabled

Options: 0 = Disabled 1 = Enabled 2 = Required

Output Format (Code 128/EAN 128)

Definition: In **Standard**, the imager will not apply special EAN output formatting options.

In **Application**, the imager will apply the special EAN output formatting options to decoded EAN-conforming symbols.

Serial Cmd: <K474,status,fixed symbol length status,fixed symbol length,EAN 128 status,output format,application record separator status,application record separator character,application record brackets,application record padding>

Default: Standard

Options: 0 = Standard 1 = Application

Application Record Separator Status (Code 128/EAN 128)

Definition: When enabled, an EAN separator will be inserted into the output between fields whenever an EAN-conforming symbol is decoded and EAN output formatting applies.

Serial Cmd: <K474,status,fixed symbol length status,fixed symbol length,EAN 128 status,output format,application record separator status,application record separator character,application record brackets,application record padding>

Default: Disabled

Options: 0 = Disabled 1 = Enabled

Application Record Separator Character (Code 128/EAN 128)

Definition: This is an ASCII character that serves as an EAN separator in formatted EAN output.

Serial Cmd: <K474,status,fixed symbol length status,fixed symbol length,EAN 128 status,output format,application record separator status,application record separator character,application record brackets,application record padding>

Default: ,

Options: Any ASCII character (7 bit)

Important: The ASCII characters <, >, and , can only be entered as hex pairs:

For <: <K474h,,,,,,3C>

For >: <K474h,,,,,,3E>

For , : <K474h,,,,,,2C>

See [ASCII Character Entry Modifier](#) on page 3-32 for a detailed explanation of how to enter ASCII characters as hex values.

Application Record Brackets (Code 128/EAN 128)

Definition: If an EAN-conforming symbol is decoded and EAN formatting applies, this feature places bracket characters around the application identifiers in the formatted output.

Serial Cmd: <K474,status,fixed symbol length status,fixed symbol length,EAN 128 status,output format,application record separator status,application record separator character,application record brackets,application record padding>

Default: Disabled

Options: 0 = Disabled 1 = Enabled

Application Record Padding (Code 128/EAN 128)

Definition: This feature causes the imager to pad variable-length application fields with leading zeroes. This is not done for the last field of a symbol.

Serial Cmd: <K474,status,fixed symbol length status,fixed symbol length,EAN 128 status,output format,application record separator status,application record separator character,application record brackets,application record padding>

Default: Enabled

Options: 0 = Disabled 1 = Enabled

BC412

- Usage:** Widely used in semiconductor manufacturing. Particularly useful where speed, accuracy, and ease of printing are required.
- Definition:** BC412 (Binary Code 412), a proprietary IBM symbology since 1988, is an alphanumeric symbol with a set of 35 characters, each encoded by a set of 4 bars in 12 module positions. All bars have a single width; it is the presence (1) or absence (0) of bars in each of the twelve module positions that make BC412 binary.
This symbology is also bi-directional and self-clocking, with a start character and a stop character.
- Note:** **BC412** is not supported when **Q-Mode** is enabled.
- Serial Cmd:** <**K481,status,check character output,fixed symbol length status,fixed symbol length**>
- Default:** **Disabled**
- Options:** **0 = Disabled** 1 = Enabled

Check Character Output (BC412)

- Usage:** **Check Character Output**, added to the symbol, provides additional security.
- Definition:** When enabled, the check character character is read and compared along with the symbol data. When disabled, symbol data is sent without the check character.
- Serial Cmd:** <**K481,status,check character output,fixed symbol length status,fixed symbol length**>
- Default:** **Disabled**
- Options:** **0 = Disabled** 1 = Enabled

Fixed Symbol Length Status (BC412)

- Definition:** When enabled, the imager will check the symbol length against the symbol length field. If disabled, any length will be considered valid.
- Serial Cmd:** <**K481,status,check character output,fixed symbol length status,fixed symbol length**>
- Default:** **Disabled**
- Options:** **0 = Disabled** 1 = Enabled

Fixed Symbol Length (BC412)

- Definition:** When enabled, the check character character is read and compared along with the symbol data. When disabled, symbol data is sent without the check character.
- Serial Cmd:** <**K481,status,check character output,fixed symbol length status,fixed symbol length**>
- Default:** **10**
- Options:** 1 to 64

Interleaved 2 of 5

Usage: I-2/5 has been popular because it is the most dense symbology for printing numeric characters less than 10 characters in length; however, Microscan does not recommend this symbology for any new applications because of inherent problems such as truncation.

Definition: A dense, continuous, self-checking, numeric symbology. Characters are paired together so that each character has five elements, two wide and three narrow, representing numbers 0 through 9, with the bars representing the first character and the interleaved spaces representing the second character. (A check character is highly recommended).

Important: You must set Symbol Length in order to decode I-2/5 symbols, unless **Range Mode** is enabled.

Serial Cmd: <**K472,status**,check character status,check character output status,symbol length #1,symbol length #2,guard bar status,range mode status>

Default: **Disabled**

Options: **0 = Disabled** 1 = Enabled

Check Character Status (Interleaved 2 of 5)

Usage: This option is not typically used, but it can be enabled for additional security in applications where the host requires redundant check character verification.

Definition: An error correcting routine in which the check character character is added.

Serial Cmd: <**K472,status**,check character status,check character output status,symbol length #1,symbol length #2,guard bar status,range mode status>

Default: **Disabled**

Options: **0 = Disabled** 1 = Enabled

Check Character Output Status (Interleaved 2 of 5)

Definition: When enabled, a check character character is sent along with the symbol data for added data security.

Serial Cmd: <**K472,status**,check character status,check character output status,symbol length #1,symbol length #2,guard bar status,range mode status>

Default: **Disabled**

Options: **0 = Disabled** 1 = Enabled

Symbol Length #1 (Interleaved 2 of 5)

- Usage:** Useful in applications where 1 2/5 symbols of a specific length are required.
- Definition:** The **Symbol Length # 1** field is one of two fields against which the decoded symbol is compared before accepting it as valid or rejecting it.
- Serial Cmd:** <K472,status,check character status,check character output,**symbol length #1**,symbol length #2,guard bar status,range mode status>
- Default:** **10**
- Options:** 0 to 64, even only.
- Important:** If **Range Mode** is disabled, the length of the symbol must match either **Symbol Length # 1** or **Symbol Length # 2** to be considered a valid symbol.
- If **Range Mode** is enabled, **Symbol Length # 1** and **Symbol Length # 2** form a range into which the length of the symbol must fall to be considered valid.

Symbol Length #2 (Interleaved 2 of 5)

- Usage:** Useful in applications where 1 2/5 symbols of a specific length are required.
- Definition:** The **Symbol Length # 2** field is one of two fields against which the decoded symbol is compared before accepting it as valid or rejecting it.
- Serial Cmd:** <K472,status,check character status,check character output,symbol length #1,**symbol length #2**,guard bar status,range mode status>
- Default:** **6**
- Options:** 0 to 64, even only.
- Important:** If **Range Mode** is disabled, the length of the symbol must match either **Symbol Length # 2** or **Symbol Length # 1** to be considered a valid symbol.
- If **Range Mode** is enabled, **Symbol Length # 2** and **Symbol Length # 1** form a range into which the length of the symbol must fall to be considered valid.

Guard Bar Status (Interleaved 2 of 5)

Note: **Guard Bar Status** is not supported when **Q-Mode** is enabled.

Note: Whenever **Guard Bar** is enabled, the presence of guard bars (also called “bearer bars”) is required for decoding to take place.

Usage: Useful when I-2/5 multisymbols are enabled to prevent false data output. This typically occurs with highly tilted or skewed symbols.

Definition: A guard bar is a heavy bar, at least twice the width of the wide bar, surrounding the printed I-2/5 symbol and helping to prevent false reads.

Serial Cmd: <**K472**,status,check character status,check character output,symbol length #1,symbol length #2,**guard bar status**,range mode status>

Default: **Disabled**

Options: **0 = Disabled** 1 = Enabled

Range Mode Status (Interleaved 2 of 5)

Usage: Useful in applications where I 2/5 symbols of a specific length are required.

Definition: When **Range Mode** is disabled, the imager checks the value of the symbol length against the values set in **Symbol Length # 1** and **Symbol Length # 2**. If the symbol length does not match either of the preset values, then it is rejected as invalid.

When **Range Mode** is enabled, **Symbol Length # 1** and **Symbol Length # 2** are combined to form a range of valid symbol lengths. Any symbol length that does not fall into this range is rejected as an invalid symbol. Either of the preset symbol length values in the **Symbol Length # 1** and **Symbol Length # 2** fields can form the start or end of the range.

Serial Cmd: <**K472**,status,check character status,check character output,symbol length #1,symbol length #2,guard bar status,**range mode status**>

Default: **Disabled**

Options: **0 = Disabled** 1 = Enabled

Code 93

Usage: Sometimes used in clinical applications.

Definition: Code 93 is a variable-length, continuous symbology employing four element widths. Each Code 93 character has nine modules that may be either black or white. Each character contains three bars and three spaces.

Serial Cmd: <**K475,status,fixed symbol length status,symbol length**>

Default: **Disabled**

Options: **0 = Disabled** 1 = Enabled

Fixed Symbol Length Status (Code 93)

Definition: When disabled, the imager will accept any Code 93 symbol provided it doesn't exceed the system's maximum capabilities.

When enabled, the imager will reject any Code 93 symbol that doesn't match the fixed symbol length.

Serial Cmd: <**K475,status,fixed symbol length status,symbol length**>

Default: **Disabled**

Options: **0 = Disabled** 1 = Enabled

Symbol Length (Code 93)

Definition: This is the symbol length value against which all Code 93 symbols will be compared.

Serial Cmd: <**K475,status,fixed symbol length status,symbol length**>

Default: **10**

Options: 1 to 64

Codabar

Usage: Used in photo-finishing and library applications. Previously used in medical applications, but not typically used in newer medical applications.

Definition: Codabar is a 16-bit character set (0 through 9, and the characters \$, :, /, ., +, and -) with start/stop codes and at least two distinctly different bar widths.

Serial Cmd: <**K471,status,start/stop match,start/stop output,large intercharacter gap,fixed symbol length status,symbol length,check character type,check character output**>

Default: **Disabled**

Options: **0 = Disabled** 1 = Enabled

Start/Stop Match (Codabar)

Definition: When disabled, the imager will decode Codabar symbols whether or not the start and stop characters are the same.

When enabled, the imager will not decode Codabar symbols unless the start and stop characters are the same.

Serial Cmd: <**K471,status,start/stop match,start/stop output,large intercharacter gap,fixed symbol length status,symbol length,check character type,check character output**>

Default: **Enabled**

Options: 0 = Disabled **1 = Enabled**

Start/Stop Output (Codabar)

Definition: When disabled, the start and stop characters will *not* be present in the data output of the decoded symbol.

When enabled, the start and stop characters *will* be present in the data output of the decoded symbol.

Note: Because the start and stop characters are included as part of the data, the characters must be included as part of the length in a fixed length mode of operation.

Serial Cmd: <**K471,status,start/stop match,start/stop output,large intercharacter gap,fixed symbol length status,symbol length,check character type,check character output**>

Default: **Enabled**

Options: 0 = Disabled **1 = Enabled**

Large Intercharacter Gap (Codabar)

Note: Large Intercharacter Gap is not supported when **Q-Mode** is enabled.

Definition: When disabled, the spaces between characters, or the “intercharacter gap”, are ignored during the decode process.

Note: If the intercharacter space is large enough to be considered a margin, the symbol will not decode, regardless of this parameter’s setting.

Serial Cmd: <**K471**,status,start/stop match,start/stop output,**large intercharacter gap**,fixed symbol length status,symbol length,check character type,check character output>

Default: **Disabled**

Options: **0 = Disabled** 1 = Enabled

Fixed Symbol Length Status (Codabar)

Definition: When disabled, the imager will accept any Codabar symbol provided it doesn’t exceed the system’s maximum capabilities.

When enabled, the imager will reject any Codabar symbol that doesn’t match the fixed length.

Serial Cmd: <**K471**,status,start/stop match,start/stop output,**large intercharacter gap**,**fixed symbol length status**,symbol length,check character type,check character output>

Default: **Disabled**

Options: **0 = Disabled** 1 = Enabled

Symbol Length (Codabar)

Definition: This is the value against which all Codabar symbol lengths will be compared.

Serial Cmd: <**K471**,status,start/stop match,start/stop output,**large intercharacter gap**,fixed symbol length status,**symbol length**,check character type,check character output>

Default: **10**

Options: 1 to 64

Check Character Type (Codabar)

Definition: When disabled, the imager will not perform any character checking calculations on decoded Codabar symbols.

When set to **Mod 16**, the imager will perform a modulus 16 check character calculation on the symbol. If the symbol does not pass this calculation, it will not be decoded.

When set to **NW7**, The imager will perform an NW7 modulus 11 check character calculation on the symbol. If the symbol does not pass this calculation, it will not be decoded.

When set to **Both**, the imager will perform both the Mod 16 and NW7 modulus 11 check character calculations on the symbol. If the symbol does not pass either calculation, it will not be decoded.

Serial Cmd: <**K471**,status,start/stop match,start/stop output,large intercharacter gap,fixed symbol length status,symbol length,**check character type**,check character output>

Default: **Disabled**

Options: **0 = Disabled** 1 = Mod 16 2 = NW7 (Mod 11)
3 = Mod 16 and NW7

Check Character Output (Codabar)

Definition: When this field is disabled and a check character calculation is enabled, the imager will strip the verified check character from the symbol data output. This condition must be accounted for if a fixed length is also being used.

When enabled, the imager will output the check character as part of the symbol data. This condition must be accounted for if a fixed length is also being used.

Serial Cmd: <**K471**,status,start/stop match,start/stop output,large intercharacter gap,fixed symbol length status,symbol length,check character type,**check character output**>

Default: **Disabled**

Options: **0 = Disabled** 1 = Enabled

UPC/EAN

Usage: Used primarily in point-of-sale applications in the retail industry. It is commonly used with Microscan readers in applications in combination with **Matchcode** when there is a need to verify that the right product is being placed in the right packaging.

Definition: **UPC** (Universal Product Code) is a fixed length, numeric, continuous symbology. UPC can have two- or five-digit supplemental bar code data following the normal code. The UPC Version A (UPC, A) symbol is used to encode a 12 digit number. The first digit is the number system character, the next five are the manufacturer number, the next five are the product number, and the last digit is the checksum character.
When enabled, the imager will read UPC Version A and UPC Version E only.

Serial Cmd: <**K473**,**UPC status**,**EAN status**,**supplementals status**,**separator status**,**separator character**,**supplemental type**,**format UPC-E as UPC-A**>

Default: **Disabled**

Options: **0 = Disabled** 1 = Enabled

EAN Status

Usage: **EAN** is the European version of the UPC symbology and is used in European market applications.

Note: **UPC** must be enabled for **EAN** to take effect.

Definition: EAN is a subset of UPC. When enabled, the imager will read UPC Version A, UPC Version E, EAN 13, and EAN 8. It also appends a leading zero to UPC Version A symbol information and transmits 13 digits. If transmitting 13 digits when reading UPC Version A symbols is not desired, disable EAN.

Note: The extra character identifies the country of origin.

Serial Cmd: <**K473**,**UPC status**,**EAN status**,**supplementals status**,**separator status**,**separator character**,**supplemental type**,**format UPC-E as UPC-A**>

Default: **Disabled**

Options: **0 = Disabled** 1 = Enabled

Supplementals Status (UPC/EAN)

Usage: Reads **Supplementals** typically used in publications and documentation.

Definition: A supplemental is a 2 to 5 digit symbol appended to the main symbol. When set to **Enabled** or **Required**, the imager reads supplemental code data that has been appended to the standard UPC or EAN codes.

Serial Cmd: <**K473**,UPC status,EAN status,**supplementals status**,separator status,separator character,supplemental type,format UPC-E as UPC-A>

Default: **Disabled**

Options: **0 = Disabled** 1 = Enabled 2 = Required

Disabled

UPC **Supplementals** will not be decoded.

Enabled

When enabled, the imager will try to decode a main and a supplemental. However, if a supplemental is not decoded, the main will be sent by itself at the end of the read cycle.

Required

When set to **Required**, both the main and the supplemental symbols must be read or a single No Read condition results.

For example, if **Supplementals** is set to **Required**, **Separator** is enabled, and an asterisk is defined as the UPC separator character. Then the data is displayed as:

MAIN * SUPPLEMENTAL.

Note: Under no circumstances will the supplemental symbol data be sent without a main symbol.

Note: If additional symbols—other than the main or supplemental—will be read in the same read cycle, **Number of Symbols** should be set accordingly.

Separator Status (UPC/EAN)

Usage: Allows users to distinguish between the main and **Supplemental** symbols.

Definition: A character can be inserted between the standard UPC or EAN symbology and the supplemental symbology when **Supplementals** is set to **Enabled** or **Required**.

Serial Cmd: <**K473**,UPC status,EAN status,supplementals status,**separator status**,separator character,supplemental type,format UPC-E as UPC-A>

Default: **Disabled**

Options: **0 = Disabled** 1 = Enabled

Separator Character (UPC/EAN)

Note: If **Separator Character** has been changed to any other character and you wish to redefine the separator as a comma, you will need to use **ESP**.

Usage: As required by the application.

Definition: Allows the user to change the separator character from a comma to a new character.

Serial Cmd: <**K473**,UPC status,EAN status,supplementals status,separator status,
separator character,supplemental type,format UPC-E as UPC-A>

Default: , (**comma**)

Options: Any ASCII character.

Note: Whenever **Separator Character** is defined as a comma (,) sending a <**K473,s?**> command will return the current settings, including the separator character comma which appears after the separator status comma.

Important: The ASCII characters <, >, and , can only be entered as hex pairs:

For <: <**K473h,,,,,3C**>

For >: <**K473h,,,,,3E**>

For , : <**K473h,,,,,2C**>

See [ASCII Character Entry Modifier](#) on page 3-32 for a detailed explanation of how to enter ASCII characters as hex values.

Supplemental Type (UPC/EAN)

Usage: As required by symbology used in application.

Definition: Allows the user to select 2 character or 5 character supplements, or both.

Serial Cmd: <**K473**,UPC status,EAN status,supplementals status,separator status,separator character,**supplemental type**,format UPC-E as UPC-A>

Default: **Both**

Options: **0 = Both** 1 = 2 characters only 2 = 5 characters only

Both

Either 2 character or 5 character supplementals will be considered valid.

2 Characters Only

Only two character supplementals will be considered valid.

5 Characters Only

Only five character supplementals will be considered valid.

Format UPC-E as UPC-A (UPC/EAN)

Definition: When disabled, the imager will output the version E symbols in their encoded 6-character format.

When enabled, the imager will format the symbol as either a 12-character UPC-A symbol or an EAN-13 symbol, depending on the state of the EAN status parameter. This formatting reverses the zero suppression that is used to generate the symbol in the UPC specification.

Serial Cmd: <**K473**,UPC status,EAN status,supplementals status,separator status,separator character,supplemental type,**format UPC-E as UPC-A**>

Default: **Disabled**

Options: **0 = Disabled** 1 = Enabled

Pharmacode

Important: Pharmacode is only available when **Q-Mode** is enabled.

Usage: Used mostly with packaging for the pharmaceuticals industry.

Definition: Encodes up to five different numbers, each with its own color, which may be entered in decimal or “binary” format with a 1 represented by a thick bar and a 0 represented by a thin bar. Bar width is independent of height. In decimal format, each part can be up to 999,999. In binary format, each input can have up to 19 ones and zeros.

Important: When Pharmacode is enabled, other linear symbologies will not decode properly. Disable Pharmacode before reading other linear symbologies.

Serial Cmd: **<K477,status,fixed symbol length status,fixed symbol length,minimum number of bars,bar width status,direction,fixed threshold value>**

Default: **Disabled**

Options: **0 = Disabled** 1 = Enabled

Fixed Symbol Length Status (Pharmacode)

Definition: When enabled, the imager will check the symbol length against the symbol length field. If disabled, any length will be considered valid.

Serial Cmd: **<K477,status,fixed symbol length status,fixed symbol length,minimum number of bars,bar width status,direction,fixed threshold value>**

Default: **Disabled**

Options: **0 = Disabled** 1 = Enabled

Fixed Symbol Length (Pharmacode)

Definition: Specifies the exact number of bars that must be present for the imager to recognize and decode the Pharmacode symbol.

Serial Cmd: **<K477,status,fixed symbol length status,fixed symbol length,minimum number of bars,bar width status,direction,fixed threshold value>**

Default: **5**

Options: 1 to 16

Minimum Number of Bars (Pharmacode)

Definition: Sets the minimum number of bars that a Pharmacode symbol must have to be considered valid.

Note: When **Q-Mode** is enabled, the minimum allowed bar count is **4**.

Serial Cmd: **<K477,status,fixed symbol length status,fixed symbol length,minimum number of bars,bar width status,direction,fixed threshold value>**

Default: **2**

Options: 1 to 16
4 to 16 (Q-Mode)

Bar Width Status (Pharmacode)

Definition: If set to **Mixed**, the imager will autodiscriminate between narrow bars and wide bars. If set to **All Narrow**, all bars will be considered as narrow bars. If set to **All Wide**, all bars will be considered as wide bars. If set to **Fixed Threshold**, it will use the fixed threshold value to determine whether the bars are narrow or wide. The **Bar Width Status** setting will be ignored when the imager is able to tell the difference between the narrow and the wide bars.

Serial Cmd: <**K477**,status,fixed symbol length status,fixed symbol length,minimum number of bars,**bar width status**,direction,fixed threshold value>

Default: **Mixed**

Options: **0 = Mixed**
1 = All Narrow
2 = All Wide
3 = Fixed Threshold

Direction (Pharmacode)

Definition: Specifies the direction in which a symbol can be read.

Serial Cmd: <**K477**,status,fixed symbol length status,fixed symbol length,minimum number of bars,bar width status,**direction**,fixed threshold value>

Default: **Forward**

Options: **0 = Forward** 1 = Reverse

Fixed Threshold Value (Pharmacode)

Definition: Used when **Bar Width Status** is set to **Fixed Threshold**. Defines the minimum difference in pixels that will distinguish a narrow bar from a wide bar.

Serial Cmd: <**K477**,status,fixed symbol length status,fixed symbol length,minimum number of bars,bar width status,direction,**fixed threshold value**>

Default: **10**

Options: 1 to 65535

Postal Symbologies

Note: Postal Symbologies are only supported when **Q-Mode** is enabled.

Important: Postal Symbologies must have a pixels-per-element value of no more than 7 to be decoded reliably by the Quadrus MINI Imager.

The imager must be configured to specific read range, field of view, and camera parameters before decoding Postal Symbologies.

For optimal decode results with a Standard Density (SD) imager:

- Set **Focal Distance** to **6"** and configure gain and shutter settings for a high contrast image.
- Enable **Pixel Sub-Sampling** at **4:1**.
- Position the imager **3.5"** to **7"** from the symbol (5-10" if Pixel Sub-Sampling is disabled).
- Position the symbol as close to the center of the imager's field of view as possible.

Note: Measurements based on a 16 mil (60 dpi) POSTNET symbol.

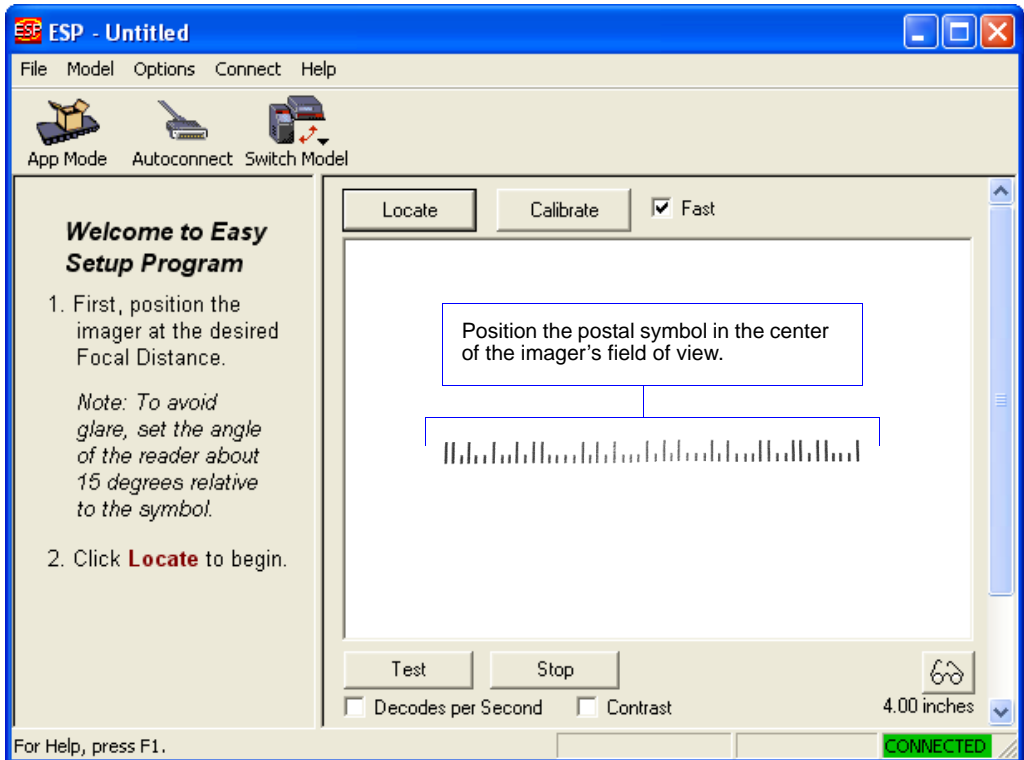

Postal Symbology Type

Usage: The following 1D **Postal Symbologies** are used in mail sortation, auditing, certified mail, registered mail, metered mail, and point-of-sale (POS) applications.

Definition: Determines the postal symbology that will be decoded by the imager. Postal symbology decode performance depends on accurate sampling density information. Sampling density is determined by measuring the width in pixels of a symbol image and then dividing that value by the width of the actual symbol in inches or meters. For example, an image of a one-inch-wide symbol that is 200 pixels across would have a sampling density of 200 dots per inch.

The following table shows the range of supported sampling densities.

Symbology	Minimum Sample Density	Maximum Sample Density	Unit of Measurement
U.S. Post (POSTNET, PLANET, USPS4CB)	80	310	dots per inch
	3150	12205	dots per meter
Australia Post	86	332	dots per inch
	3386	13071	dots per meter
Japan Post	84	324	dots per inch
	3307	12756	dots per meter
Royal Mail, KIX	82	317	dots per inch
	3228	12489	dots per meter
UPU	80	310	dots per inch
	3150	12205	dots per meter

Serial Cmd: <**K460,postal symbology type**,POSTNET status,PLANET status,USPS4CB status,POSTNET allow B and B' fields,Australia Post allow 0 FCC>

Default: **Disabled**

Options: **0 = Disabled**

- 1 = U.S. Post (POSTNET, PLANET, USPS4CB)
- 2 = Australia Post
- 3 = Japan Post
- 4 = Royal Mail
- 5 = KIX
- 6 = UPU

U.S. Post (POSTNET, PLANET, USPS4CB)

When **U.S. Post** is enabled (<K460,1>), the imager will only decode **POSTNET**, **PLANET**, and **USPS4CB** symbols.

Important: POSTNET Status, **PLANET Status**, and **USPS4CB Status** are enabled by default. However, if any of the three U.S. Post symbologies is set to **disabled** individually, symbols of that type will not be decoded by the imager even when U.S. Post is enabled.

For example, if **U.S. Post** is enabled but **POSTNET Status** is disabled (<K460,1,0>), **POSTNET** symbols will not be decoded by the imager.

See **POSTNET Status**, **PLANET Status**, and **USPS4CB Status** for more detail about U.S. Post symbologies.

Australia Post

When **Australia Post** is enabled (<K460,2>), the imager will only decode Australia Post symbols.

Japan Post

When **Japan Post** is enabled (<K460,3>), the imager will only decode Japan Post symbols.

Royal Mail

When **Royal Mail** is enabled (<K460,4>), the imager will only decode Royal Mail symbols.

KIX

When **KIX** is enabled (<K460,5>), the imager will only decode KIX symbols.

UPU

When **UPU** is enabled, the imager will decode UPU symbols *and* any **U.S. Post** symbologies that might be enabled.

For example, if **Postal Symbology Type** is set to **UPU** and **POSTNET Status** is enabled and (<K460,6,1>), the imager will attempt to decode both UPU and POSTNET symbols.

POSTNET Status

Usage: **POSTNET** is used by the United States Postal Service to direct mail. The ZIP Code or ZIP+4 Code is encoded in the symbol. Data is encoded in half-height and full-height bars, making POSTNET a “2-state” symbology. The delivery point (usually the last two digits of the address or post office box number) is also typically encoded in POSTNET symbols.

Definition: If **U.S. Post** and **POSTNET Status** are both enabled, the imager will decode POSTNET symbols.

Serial Cmd: <**K460**,postal symbology type,**POSTNET status**,PLANET status,USPS4CB status,POSTNET allow B and B' fields,Australia Post allow 0 FCC>

Default: **Enabled**

Options: 0 = Disabled
1 = Enabled

PLANET Status

Usage: **PLANET (Postal Alphanumeric Encoding Technique)** is a symbology used by the United States Postal Service to track and identify items during delivery. Each PLANET symbol is either 12 or 14 digits long, and encodes data in half-height and full-height bars, making PLANET a “2-state” symbology. The symbol always starts and ends with a full-height bar, or “guard rail”, and each individual digit is represented by a set of five bars in which two of the bars are always short.

Definition: If **U.S. Post** and **PLANET Status** are both enabled, the imager will decode PLANET symbols.

Serial Cmd: <**K460**,postal symbology type,POSTNET status,**PLANET status**,USPS4CB status,POSTNET allow B and B' fields,Australia Post allow 0 FCC>

Default: **Enabled**

Options: 0 = Disabled
1 = Enabled

USPS4CB Status

Usage: **USPS4CB**, also called **Intelligent Mail**, is used by the United States Postal Service to sort and track individual items as well as flats of mail. USPS4CB combines the capabilities of POSTNET and PLANET, and can encode 31 digits (65 bars). USPS4CB symbols are slightly longer than POSTNET symbols, and offer additional flexibility in choosing symbol height and width. Data is encoded in four types of bars (“states”), each of which is identified by a name and a value. This type of postal symbol is known as “4-state”. Each bar has a “tracker”, or middle section, to which an “ascender” (top section) or “descender” (bottom section) may be added. The 4-state format allows the symbol to contain more information, and makes it easier to decode. 4-state symbols can also be printed easily in a variety of media, including dot matrix, inkjet, and laser.

Definition: If **U.S. Post** and **USPS4CB Status** are both enabled, the imager will decode USPS4CB symbols.

Serial Cmd: <**K460**,postal symbology type,POSTNET status,PLANET status,**USPS4CB status**,POSTNET allow B and B' fields,Australia Post allow 0 FCC>

Default: **Enabled**

Options: 0 = Disabled

1 = Enabled

POSTNET Allow B and B' Fields

Definition: If **U.S. Post** and **POSTNET** are enabled, and **POSTNET Allow B and B' Fields** is enabled, the imager will allow B and B' fields in POSTNET symbols.

Serial Cmd: <**K460**,postal symbology type,POSTNET status,PLANET status,USPS4CB status,**POSTNET allow B and B' fields**,Australia Post allow 0 FCC>

Default: **Disabled**

Options: **0 = Disabled**

1 = Enabled

Australia Post Allow 0 FCC

Definition: If **Australia Post** is enabled, and **Australia Post Allow 0 FCC** is enabled, the imager will allow 0 FCC in Australia Post symbols.

Serial Cmd: <**K460**,postal symbology type,POSTNET status,PLANET status,USPS4CB status,POSTNET allow B and B' fields,**Australia Post allow 0 FCC**>

Default: **Disabled**

Options: **0 = Disabled**

1 = Enabled

GS1 DataBar (RSS)

Note: GS1 DataBar symbologies were previously known as “Reduced Space Symbology”, or “RSS”.

DataBar Expanded (RSS Expanded)

Note: DataBar Expanded was previously known as “RSS Expanded”.

Usage: Used to encode primary and supplementary data in retail point-of-sale and other applications.

Definition: DataBar Expanded is a variable length symbology that can encode supplementary information in addition to the 14-digit EAN item identification number and is capable of encoding up to 74 numeric or 41 alphabetic characters.

Serial Cmd: **<K484,status,fixed symbol length status,fixed symbol length>**

Default: **Disabled**

Options: **0 = Disabled**
1 = Enabled (non-stacked)
2 = Enabled (stacked and non-stacked)

Where appropriate, use 1 (non-stacked) for better performance over 2 (stacked and non-stacked).

Fixed Symbol Length Status (DataBar Expanded)

Definition: When enabled, the imager will check the symbol length against the symbol length field, minus the embedded check character. If disabled, any length would be considered valid.

Serial Cmd: **<K484,status,fixed symbol length status,fixed symbol length>**

Default: **Disabled**

Options: **0 = Disabled** 1 = Enabled

Fixed Symbol Length (DataBar Expanded)

Usage: **Fixed Symbol Length** helps prevent truncations and increases data integrity by ensuring that only one symbol length will be accepted.

Definition: Specifies the exact number of characters that the imager will recognize (this does not include start, stop, and check character characters). The imager ignores any symbol not having the specified length.

Serial Cmd: **<K484,status,fixed symbol length status,fixed symbol length>**

Default: **14**

Options: 1 to 74

DataBar Limited (RSS Limited)

Note: DataBar Limited was previously known as “RSS Limited”.

Usage: DataBar Limited is designed to be read by laser and CCD readers. It is not recommended for omnidirectional slot scanners.

Definition: Encodes a smaller 14-digit symbol (74 modules wide) that is not omnidirectional.

Serial Cmd: <K483,status>

Default: Disabled

Options: 0 = Disabled 1 = Enabled

DataBar-14 (RSS-14)

Note: DataBar-14 was previously known as “RSS-14”.

Usage: Used in the grocery, retail, and prescription drug industries where 14-digit EAN item identification may be needed.

Definition: DataBar-14 is a fixed symbol length symbology that encodes 14 digits, including a 1-digit indicator. DataBar-14 is 96 modules wide. It can be stacked in two rows, it can read omnidirectionally if printed in full height, or horizontally if height-truncated for small marking.

Serial Cmd: <K482,status>

Default: Disabled

Options: 0 = Disabled
1 = Enabled (non-stacked)
2 = Enabled (stacked; decode both stacked and non-stacked)

Note: Where appropriate, use 1 (non-stacked) for better performance over 2 (stacked; decode both stacked and non-stacked).

PDF417

Usage: Used in applications where a large amount of information (over 32 characters) needs to be encoded within a symbol, typically where the symbol is transported from one facility to another. For example, an automobile assembly line might use a single symbol with multiple fields of information that will be read at several stations along the way, without reference to a database.

Definition: A two-dimensional, multi-row (3 to 90), continuous, variable length symbology that has high data capacity for storing up to 2,700 numeric characters, 1800 printable ASCII characters, or 1100 binary characters per symbol. Each symbol character consists of 4 bars and 4 spaces in a 17-module structure.

Serial Cmd: `<K476,status,[unused],fixed symbol length status,fixed symbol length,[unused],codeword collection>`

Default: **Disabled**

Options: **0 = Disabled** 1 = Enabled

Note: Sending `<a1>` will cause PDF417 data to be prefaced with information consisting of error correction level (ECC Level *n*), number of rows (*n* Rows), number of columns (*n* Columns), number of informative code words (*n* Info Code Words) and the number of data characters (*n* Data Characters). This feature can be disabled by re-sending `<a1>`.

Fixed Symbol Length Status (PDF417)

Serial Cmd: `<K476,status,[unused],fixed symbol length status,fixed symbol length,[unused],codeword collection>`

Default: **Disabled**

Options: **0 = Disabled** 1 = Enabled

Fixed Symbol Length (PDF417)

Usage: Used to increase data integrity by ensuring that only one symbol length will be accepted.

Definition: When enabled, the PDF symbol must contain the same number of characters as the symbol length setting before it can be considered a good read. The imager will ignore any symbol not having the specified length.

Serial Cmd: `<K476,status,[unused],fixed symbol length status,fixed symbol length,[unused],codeword collection>`

Default: **10**

Options: 1 to 2710

Note: Fixed Symbol Length Status must be enabled for Fixed Symbol Length to take effect.

Codeword Collection (PDF417)

Note: Codeword Collection is not supported when **Q-Mode** is enabled.

Usage: **Multiple Codeword Collection** is useful in applications where portions of subsequent images can be read and pieced together so that no opportunity or time is lost to assemble codewords for decoding.

Definition: When set to **Multiple**, PDF codewords are collected from multiple images and assembled throughout the read cycle until the read cycle ends or the symbol is fully decoded. It is important to note that when this feature is enabled, only one PDF symbol should be presented to the imager per read cycle.

Serial Cmd: `<K476,status,[unused],fixed symbol length status,fixed symbol length,[unused],codeword collection>`

Default: **Single Image**

Options: **0 = Single Image** 1 = Multiple Image

MicroPDF417

- Usage:* Used for labelling small items that need large data capacity.
- Definition:* A variant of PDF417, a very efficient and compact stacked symbology that can encode up to 250 alphanumeric characters or 366 numeric characters per symbol.
- Serial Cmd:* <**K485,status**,[unused],fixed symbol length status,fixed symbol length>
- Default:* **Disabled**
- Options:* **0 = Disabled** 1 = Enabled

Fixed Symbol Length Status (MicroPDF417)

- Serial Cmd:* <**K485,status**,[unused],**fixed symbol length status**,fixed symbol length>
- Default:* **Disabled**
- Options:* **0 = Disabled** 1 = Enabled

Fixed Symbol Length (MicroPDF417)

- Usage:* Used to increase data integrity by ensuring that only one symbol length will be accepted.
- Definition:* When enabled, the MicroPDF417 symbol must contain the same number of characters as the symbol length setting before it can be considered a good read. The imager will ignore any symbol not having the specified length.
- Serial Cmd:* <**K485,status**,[unused],fixed symbol length status,fixed symbol length>
- Default:* **10**
- Options:* 1 to 366

Note: Fixed Symbol Length Status must be enabled for Fixed Symbol Length to take effect.

Composite

When set to **Enabled** or **Required**, will decode the 2D composite component of a linear symbol. The linear symbol can be DataBar-14, DataBar Expanded, DataBar Limited, EAN-128, UPC-A, EAN-13, EAN-8, and UPC-E.

Usage: Allows reading by both linear and 2D readers.

Definition: Combines 2D and linear width-modulated symbology on the same symbol where different messages can be read by each reader type.

Serial Cmd: **<K453,mode,separator status,separator>**

Default: **Disabled**

Options: **0 = Disabled** 1 = Enabled 2 = Required

Enabled

If **Composite** is set to **Enabled**, the imager will decode both the 2D composite and linear components. However, if the 2D composite component is not decoded, the linear data will be sent by itself at the end of the read cycle.

Required

If set to **Required**, the imager must decode both components, or a No Read will occur.

Separator Status (Composite)

Usage: Allows the user to distinguish between the main and **Supplemental** symbols.

Definition: Separates the linear and the composite component.

Serial Cmd: **<K453,mode,separator status,separator>**

Default: **Disabled**

Options: **0 = Disabled** 1 = Enabled

Separator Character (Composite)

Note: The Separator Character will be the same as the character defined in the **Multisymbol Separator** field of the **<K222>** command.

Usage: As required by the application.

Definition: Allows the user to change the separator character from a comma to a new character.

Serial Cmd: **<K453,mode,separator status,separator>**

Default: **,** (comma)

Options: Any ASCII character.

Important: The ASCII characters **<**, **>**, and **,** can only be entered as hex pairs:

For **<**: **<K453h,,,3C>**

For **>**: **<K453h,,,3E>**

For **,**: **<K453h,,,2C>**

See **ASCII Character Entry Modifier** on page 3-32 for a detailed explanation of how to enter ASCII characters as hex values.

Narrow Margins/Symbology Identifier

Narrow Margins

Usage: Used when the leading and trailing edges of the symbols are smaller than the standard margin or other objects encroach into the margins.

Definition: Allows the imager to read 1D symbols with quiet zones less than 8 times the width of the narrow bar element. “Quiet zone” is the space at the leading and trailing ends of a symbol. Each quiet zone can be as narrow as only five times the width of the narrow bar element when **Narrow Margins** is enabled.

Serial Cmd: <K450,narrow margins,symbology identifier status>

Default: **2D Enhanced**

Options: 0 = Disabled 1 = Enabled **2 = 2D Enhanced**

Note: Do not use **Narrow Margins** when **Large Intercharacter Gap** is enabled for Code 39.

Enabled

When **Narrow Margins** is set to **Enabled**, the imager uses a 5x margin requirement for standard linear symbols.

Note: When **Q-Mode** is enabled, **Narrow Margins** only supports linear symbols.

2D Enhanced

2D Enhanced enables a special decode algorithm for narrow-margin 2D symbols.

Symbology Identifier

Definition: Symbology Identifier is an ISO/IEC 16022 standard prefix set of characters that identifies the symbol type.

When enabled, the imager analyzes and identifies the symbology and adds a three-character identifying prefix to the data:

-] (closed bracket character) indicating the presence of a symbology identifier.
- A, C, E, F, G, I, L, Q, Y, b, d, e, p, z
- (A = Code 39; C = Code 128; E = UPC/EAN; F = Codabar; G = Code 93; I = I-2/5; L = PDF417 and MicroPDF417; Q = QR Code and Micro QR Code; Y = Postal Symbologies; b = BC412; d = Data Matrix; e = GS1 DataBar (RSS); p = Pharmacode; z = Aztec)
- Modifier

Example:]d indicates a Data Matrix symbol.

Serial Cmd: <K450, narrow margins, **symbology identifier status**>

Default: Disabled

Options: 0 = Disabled 1 = Enabled

Explanation of Modifiers for Code 39, Codabar, and I-2/5

- For Code 39, Codabar, and I-2/5, the modifier indicates **Check Character** and **Check Character Output** status.
- For Code 39 only, Full ASCII must be enabled to see modifiers 4, 5, and 7.

Modifier	Check Character	Check Character Output	Full ASCII conversion performed (Code 39 only)
0	Disabled	N/A	No
1	Enabled	Enabled	No
3	Enabled	Disabled	No
4	Disabled	N/A	Yes
5	Enabled	Enabled	Yes
7	Enabled	Disabled	Yes

Example:]A5 indicates a **Code 39** symbol with **Check Character** and **Check Character Output** enabled and Full ASCII conversion performed.

Explanation of Modifiers for Other Symbologies

- For Code 128, a 1 indicates EAN 128; otherwise the modifier is 0.
- For QR Code and Micro QR Code, a 0 indicates QR Code; a 1 indicates Micro QR Code.
- For Postal Symbologies, a 0 indicates POSTNET; a 1 indicates Japan Post; a 2 indicates Australia Post; a 3 indicates PLANET; a 4 indicates Royal Mail; a 5 indicates KIX; a 6 indicates UPU (56-bar); a 7 indicates UPU (75-bar); and an 8 indicates USPS4CB.

Example:]Y0 indicates a **POSTNET** symbol.

- For all other symbologies, the modifier is 0.

Background Color

Usage: Symbol backgrounds are often **White**, or other very light colors. If the background is darker than the symbol, **Black** background should be enabled.

Note: When Q-Mode is enabled, **Black** background is only supported for Aztec Code, Data Matrix, QR Code, and Micro QR Code.

Definition: Allows the user to specify the symbol background used in the application.

Serial Cmd: **<K451,background color>**

Default: **Both**

Options: 0 = White 1 = Black **2 = Both**

White

When **White** background is enabled, the bars of linear symbols and the elements of 2D symbols are recognized as dark on a light background.

Black

When **Black** background is enabled, the bars of linear symbols and the elements of 2D symbols are recognized as light on a dark background.

Both

When **Both** is enabled, the imager will attempt to decode for white background first, and if there is no decode, will then attempt to decode for black background.

7 I/O Parameters

Contents

I/O Parameters by ESP	7-2
I/O Parameters Serial Commands	7-3
Symbol Data Output	7-4
No Read Message.....	7-7
Bad Symbol Message	7-10
No Symbol Message	7-10
1D/Stacked Symbology Qualification	7-11
2D Symbology Qualification	7-12
Read Duration Output	7-18
Output Indicators	7-19
Beeper.....	7-23
LED Configuration	7-24
Serial Verification	7-25
EZ Button	7-27
EZ Button Modes.....	7-29
Configurable Output 1	7-31
Trend Analysis Output 1	7-34
ISO/IEC 16022 Symbol Quality Output 1	7-37
Diagnostic Output 1.....	7-40
Configurable Output 2	7-41
Trend Analysis Output 2.....	7-41
ISO/IEC 16022 Symbol Quality Output 2	7-41
Diagnostic Output 2.....	7-41
Configurable Output 3	7-42
Trend Analysis Output 3.....	7-42
ISO/IEC 16022 Symbol Quality Output 3	7-42
Diagnostic Output 3.....	7-42
Power-On/Reset Counts	7-43
Time Since Reset.....	7-44
Service Message.....	7-45
Frame Information.....	7-46
Image Output.....	7-47
Database Identifier Output	7-50
Quality Output	7-51
Configuring EZ Trax Output	7-52

This section includes instructions on setting up conditions for changing input/output electrical transitions for control of the imager's internal and external devices. A discrete I/O (in/out) signal is an electrical transition from one voltage level to another so that digital switching can occur.

I/O Parameters by ESP

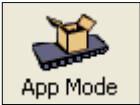

Click this button to bring up the **App Mode** view.

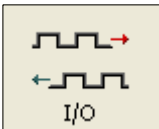

Click this button to bring up the **I/O Parameters** tree control.

Parameters	ESP Values
[-] I/O Parameters	
+ Symbol Data Output	Good Read
+ Noread Message	Enabled
+ Bad / No Symbol Qualification	
+ Read Duration Output	Disabled
+ Output Object Info	Disabled
+ Output Indicators	
+ Serial Verification	
+ Image Output	Disabled
+ EZ Trax Output	Disabled
+ EZ Button	Enabled*
+ Calibration Options	Disabled
+ Database Identifier Output	Enabled*
+ Output 1 Parameters	Trigger
+ Output 2 Parameters	Unlatch Outputs
+ Output 3 Parameters	Parameter switch
+ Quality Output	

To open nested options, **single-click** the +.

To change a setting, **double-click** the setting and use your cursor to scroll through the options.

I/O Parameters Serial Commands

Power On/Reset Counts	<K406,power-on,resets,power-on saves,power-on flash saves>
Time Since Reset	<K407,hours,minutes>
Service Message	<K409,status,service message,threshold,resolution>
Serial Verification	<K701,serial command echo status,serial command beep status,control/hex output>
Beeper	<K702,status>
Quality Output	<K704,quality output separator,decodes/trigger status>
Symbol Data Output	<K705,symbol data output status,when to output>
Read Duration Output	<K706,status,separator>
No Read Message	<K714,status,message>
Bad Symbol Message	<K715,[unused],message>
No Symbol Message	<K716,[unused],message>
1D/Stacked Symbology Qualification	<K717,minimum number of bars,minimum number of qualified scan lines,start/stop status>
2D Symbology Qualification	<K718,finder pattern status,symbol size status,symbol size 1,symbol size 2,symbol size tolerance,dimension status,dimension 1,dimension 2,dimension tolerance,orientation status,orientation value>
Frame Information	<K734,output frame number,output coordinates>
LED Configuration	<K737,LED mode,ISO/IEC 16022 grade>
Image Output	<K739,image output mode,communication port,file format,jpeg quality>
Target/Flood LEDs	<K750,green flash LED status,target pattern LED status,green flash duration>
EZ Trax Output	<K757,comm port,image mode,image format,jpeg quality,object info output,grade output>
Database Identifier Output	<K759,status,separator>
EZ Button	<K770,global status,default on power-on,load configuration database,save for power-on>
EZ Button Modes	<K771,single beep,two beeps,three beeps,four beeps>
Trend Analysis Output 1	<K780,trend analysis mode,trigger evaluation period,number to output on>
Trend Analysis Output 2	<K781,trend analysis mode,trigger evaluation period,number to output on>
Trend Analysis Output 3	<K782,trend analysis mode,trigger evaluation period,number to output on>
Diagnostic Output 1	<K790,unused 1,service unit>
Diagnostic Output 2	<K791,unused 1,service unit>
Diagnostic Output 3	<K792,unused 1,service unit>
ISO/IEC 16022 Symbol Quality Output 1	<K800,output on symbol contrast,symbol contrast threshold,output on print growth,print growth threshold,output on axial non-uniformity,axial non-uniformity threshold,output on UEC,UEC threshold>
ISO/IEC 16022 Symbol Quality Output 2	<K801,output on symbol contrast,symbol contrast threshold,output on print growth,print growth threshold,output on axial non-uniformity,axial non-uniformity threshold,output on UEC,UEC threshold>
ISO/IEC 16022 Symbol Quality Output 3	<K802,output on symbol contrast,symbol contrast threshold,output on print growth,print growth threshold,output on axial non-uniformity,axial non-uniformity threshold,output on UEC,UEC threshold>
Configurable Output 1	<K810,output on,output state,pulse width,output mode>
Configurable Output 2	<K811,output on,output state,pulse width,output mode>
Configurable Output 3	<K812,output on,output state,pulse width,output mode>

Symbol Data Output

Symbol Data Output Status

Note: **Symbol Data Output** relates to data and should not be confused with **Outputs 1, 2, and 3** listed in the **Output Parameters** which describe output states and functions.

Usage: Useful when the host needs symbol data only under certain conditions.

Definition: Defines the conditions under which decoded symbol data is transmitted to the host.

Serial Cmd: **<K705,symbol data output status,when to output>**

Default: **Good Read**

Options: 0 = Disabled
1 = Match
2 = Mismatch
3 = Good Read

Note: **Symbol Data Output Status**, if set to **Match** or **Mismatch**, will not take effect unless **Matchcode Type** is enabled and a master symbol is loaded into memory.

Disabled

Usage: It is useful when an application only needs to use the discrete outputs and can allow the imager to do the decision-making. When **Disabled**, the host does not need the symbol data and the communication lines are used only for setup and status checks.

Definition: When set to **Disabled**, the imager will not transmit any data that is generated during a read cycle (symbols, No Reads, etc.)

Match

Usage: **Match** is used in an application that requires specific symbol information and needs to sort, route, or verify based on matching the specific symbol data.

Definition: When set to **Match**, the imager transmits symbol data whenever a symbol matches a master symbol. However, if **Matchcode Type** is **Disabled**, it transmits on any good read.

Note: A No Read can still be transmitted if **Enabled**.

Mismatch

Usage: Mismatch is typically used as a flag within the host system to prevent an item from being routed in the wrong container.

Definition: With Mismatch enabled, the imager transmits symbol data whenever the symbol data information does NOT match the master symbol.

Note: A No Read can still be transmitted if **Enabled**.

Good Read

Usage: **Good Read** is used when an application requires all symbol data to be transmitted. It's typically used in tracking applications in which each object is uniquely identified.

Definition: With **Good Read** enabled, the imager transmits symbol data on any good read regardless of **Matchcode Type** setting.

Note: A No Read can still be transmitted if **Enabled**.

When to Output Symbol Data

Definition: This command allows the user to choose when symbol data can be sent to the host.

Serial Cmd: <K705,symbol data output status,**when to output**>

Default: **As Soon As Possible**

Options: **0 = ASAP** 1 = End of Read Cycle

As Soon As Possible

Usage: **As Soon As Possible** is useful in applications in which symbol data needs to be moved quickly to the host, typically when the host is making decisions based on symbol data.

Definition: Enabling **As Soon As Possible** causes symbol data to be sent to the host immediately after a symbol has been successfully decoded.

Note: More than one decode might in fact be required to qualify as a good read, depending on how **Decodes Before Output** is set.

End of Read Cycle

Usage: **End of Read Cycle** is useful in timing-based systems in which the host is not ready to accept data at the time that it is decoded.

Definition: Enabling **End of Read Cycle** means that symbol data does not get sent to the host until the read cycle ends with a timeout or new trigger.

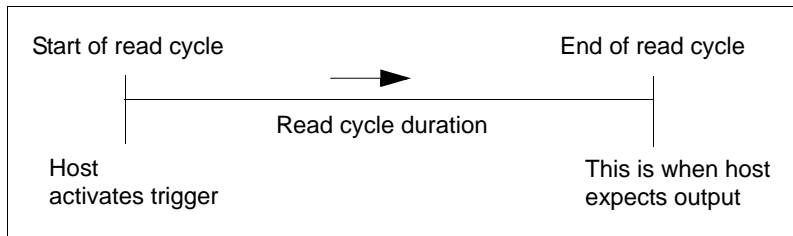

No Read Message

Usage: Used in applications where the host needs serial verification that a symbol has not been read and especially useful in new print verification.

Definition: When enabled, and if no symbol has been decoded before timeout or the end of the read cycle, the No Read message will be transmitted to the host.

No Read Message Mode

Serial Cmd: <K714,**No Read message status**,No Read message>

Default: **Enabled**

Options: 0 = Disabled **1 = Enabled** 2 = Detailed No Read Message

Disabled

Only symbol data is output after a read cycle.

Enabled

When the imager is in a triggered mode, a No Read message will be appended for each failed read attempt.

Detailed No Read Message

Important: In the case where the conditions set in **Bad Symbol/No Symbol Qualification** are met, then the **Bad Symbol** or **No Symbol** message output will override the **No Read Message** or the **Detailed No Read Message**, if either is enabled.

Note: **Detailed No Read Message** is not supported when **Q-Mode** is enabled.

Usage: Use this option to cover more detailed reasons for decode failures.

Definition: Outputs a **No Read** message followed by an additional message (an Image Processing Results Code) indicating the reason a symbol failed to decode.

For example, in the following output: "No Read d_1, E_2", d and E are symbology i.d.s for Data Matrix and UPC respectively. The message means that Data Matrix and UPC are enabled (and other symbologies are not), and that both failed to decode. The reason for the failing Data Matrix is 1 and the reason for the failing UPC is 2. The first part of these numbers (preceding the dot) is the relevant number and is interpreted here:

2D Symbols:

1. Failed to locate symbol (no finder pattern).
2. Failed to locate four corners or failed to qualify user defined dimensions (in pixels).
3. Failed to locate clock patterns or failed to qualify user defined orientation (0-359 degree).
4. Failed to validate clock patterns or failed to qualify user defined symbol size (clock element count).
5. Failed to decode symbol.

No Read Message

Linear (1D) Symbols:

1. Failed user defined minimum number of bars.
2. Failed to decode start/stop character (doesn't apply to UPC, GS1 DataBar (RSS), MicroPDF417, or Pharmacode).
3. Failed user defined minimum number of scan lines that qualify for the minimum number of bars.
4. Failed to decode.
5. Failed to decode UPC supplemental.

No Read Message

Definition: Any combination of ASCII characters can be defined as the No Read message.

Serial Cmd: <K714,No Read message status,**No Read message**>

Default: **No Read**

Options: A string of up to 64 characters.

Note: **No Read Message** will only be transmitted if **Symbol Data Output** is set to **Match**, **Mismatch**, or **Good Read**.

No Read Message can be set to any ASCII character.

Important: The ASCII characters <, >, and , can only be entered as hex pairs:

For <: <K714h,,3C>

For >: <K714h,,3E>

For , : <K714h,,2C>

See [ASCII Character Entry Modifier](#) on page 3-32 for a detailed explanation of how to enter ASCII characters as hex values.

Bad Symbol Message

Note: **Bad Symbol Message** is not supported when **Q-Mode** is enabled.

Usage: Useful in determining if a symbol is present and if user defined requirements for that symbol are met. Can tell the user if a qualified symbol is present but not decodable.

Definition: Sets the requirements that will qualify an object or a symbol before outputting a decode or message. When enabled, sends a message to the host whenever an object meets the qualifications setup but is not decoded.

Note: When **Symbology Identifier** is enabled, the **Bad Symbol** message is preceded by the identifier for the symbology being used.

Serial Cmd: **<K715,[unused],message>**

Default: **BAD_SYMBOL**

Options: Up to 64 ASCII characters.

Important: The ASCII characters **<**, **>**, and **,** can only be entered as hex pairs:

For **<**: **<K715h,,3C>**

For **>**: **<K715h,,3E>**

For **,**: **<K715h,,2C>**

See **ASCII Character Entry Modifier** on page 3-32 for a detailed explanation of how to enter ASCII characters as hex values.

No Symbol Message

Note: **No Symbol Message** is not supported when **Q-Mode** is enabled.

Usage: Useful in determining if a symbol is present and if user defined requirements for that symbol are met. Can tell the user if an object does not qualify as a symbol.

Definition: Sets the requirements that will qualify an object or a symbol before outputting a decode or message. When enabled, sends a message to the host whenever an object meets the qualifications setup but is not decoded.

Note: When **Symbology Identifier** is enabled, the **No Symbol** message is preceded by the identifier for the symbology being used.

Serial Cmd: **<K716,[unused],message>**

Default: **NO_SYMBOL**

Options: Up to 64 ASCII characters.

Important: The ASCII characters **<**, **>**, and **,** can only be entered as hex pairs:

For **<**: **<K716h,,3C>**

For **>**: **<K716h,,3E>**

For **,**: **<K716h,,2C>**

See **ASCII Character Entry Modifier** on page 3-32 for a detailed explanation of how to enter ASCII characters as hex values.

1D/Stacked Symbology Qualification

Note: 1D/Stacked Symbology Qualification is not supported when **Q-Mode** is enabled.

Minimum Number of Bars

Definition: Sets the minimum number of bars to qualify linear symbols.

Serial Cmd: <**K717**,*minimum number of bars*,*minimum number of qualified scan lines*,*start/stop status*>

Default: **0**

Options: 0 to 255 (0 = disabled)

Minimum Number of Qualified Scan Lines

Definition: Sets the minimum number of scans that have the required number of bars set in **Minimum Number of Bars**.

Note: This is a percentage value, from 0 to 100.

Serial Cmd: <**K717**,*minimum number of bars*,*minimum number of qualified scan lines*,*start/stop status*>

Default: **Disabled**

Options: 0 to 100 (0 = disabled).

Start/Stop Status

Definition: When enabled, both **Start** and **Stop** characters need to be present to qualify as a decodable symbol. In the case of PDF417, only a **Stop** needs to be present.

Note: This parameter does not apply to UPC, GS1 DataBar (RSS), MicroPDF417, or Pharmacode.

Serial Cmd: <**K717**,*minimum number of bars*,*minimum number of qualified scan lines*,*start/stop status*>

Default: **Disabled**

Options: **0 = Disabled** 1 = Enabled

2D Symbology Qualification

Note: 2D Symbology Qualification is not supported when **Q-Mode** is enabled.

Note: In the cases where **Symbol Size Status**, **Dimension Status**, or **Orientation Status** is enabled, the imager will always check the finder pattern regardless of **Finder Pattern Status** setting.

Finder Pattern Status

Definition: Checks for the presence of a finder pattern.

Serial Cmd: <K718,finder pattern status,symbol size mode,symbol size 1,symbol size 2,symbol size tolerance,dimension mode,dimension 1,dimension 2,dimension tolerance,orientation mode,orientation value>

Default: Disabled

Options: 0 = Disabled 1 = Enabled

Symbol Size Mode

Note: If **Symbol Size 1** is larger than **Symbol Size 2**, it will be automatically reversed in the algorithm.

Definition: Specifies the outputs resulting from the searches for **Symbol Size 1** and **Symbol Size 2**.

Serial Cmd: <K718,finder pattern status,symbol size mode,symbol size 1,symbol size 2,symbol size tolerance,dimension mode,dimension 1,dimension 2,dimension tolerance,orientation mode,orientation value>

Default: Disabled

Options: 0 = Disabled
1 = Bad/No Symbol Output
2 = Object Qualification
3 = Enable Both

Disabled

Decoded messages are output, but no attempt to qualify symbols or output Bad or No Symbol messages is undertaken.

Bad/No Symbol Output

Checks first for decodes. If no symbol is decoded, checks for symbol size. If both **Symbol Size 1** and **Symbol Size 2** requirements are met, a **Bad Symbol** message is output. If neither are met, a **No Symbol** message is output.

Object Qualification

Checks first for matches to symbol size. If qualified, attempts to decode. If no decodes are found within the specified read cycle parameters, outputs a **No Read** message.

Enable Both

Same as **Object Qualification**, except that if no objects qualify, then a **No Symbol** message is output; if at least one object qualifies, then a **Bad Symbol** message is output.

Symbol Size 1

Definition: Checks for symbol sizes for a specified number of elements. In the case of rectangular symbols, checks the longer side.

Serial Cmd: <K718,finder pattern status,symbol size mode,**symbol size 1**,symbol size 2,symbol size tolerance,dimension mode,dimension 1,dimension 2,dimension tolerance,orientation mode,orientation value>

Default: **10**

Options: 8 to 88 elements

Symbol Size 2

Definition: Checks for symbol sizes for a specified number of elements. In the case of rectangular symbols, checks the shorter side.

Serial Cmd: <K718,finder pattern status,symbol size mode,symbol size 1,**symbol size 2**,symbol size tolerance,dimension mode,dimension 1,dimension 2,dimension tolerance,orientation mode,orientation value>

Default: **10**

Options: 8 to 88 elements

Symbol Size Tolerance

Definition: Sets the allowable deviation, up or down, for symbol sizes specified in **Symbol Size 1** and **Symbol Size 2**.

Serial Cmd: <K718,finder pattern status,symbol size mode,symbol size 1,symbol size 2,**symbol size tolerance**,dimension mode,dimension 1,dimension 2,dimension tolerance,orientation mode,orientation value>

Default: **2**

Options: 0 to 10

Dimension Mode

Definition: Enables searches for symbol Dimension 1 and Dimension 2.

Serial Cmd: <K718,finder pattern status,symbol size mode,symbol size 1,symbol size 2,symbol size tolerance,dimension mode,dimension 1,dimension 2,dimension tolerance,orientation mode,orientation value>

Default: Disabled

Options: **0 = Disabled**
1 = Bad/No Symbol Output
2 = Object Qualification
3 = Enable Both

Disabled

Decoded messages are output, but no attempt to qualify symbols or output **Bad Symbol** or **No Symbol** messages is undertaken.

Bad/No Symbol Output

Checks first for decodes. If no symbol is decoded, checks for symbol dimension. If both **Dimension 1** and **Dimension 2** requirements are met, a **Bad Symbol** message is output. If neither are met, a **No Symbol** message is output.

Object Qualification

Checks first for matches to symbol dimension. If qualified, attempts to decode. If no decodes are found within the specified read cycle parameters, outputs a **No Read** message.

Enable Both

Same as **Object Qualification**, except that if neither **Dimension 1** nor **Dimension 2** qualifies, then a **No Symbol** message is output; if either **Dimension 1** or **Dimension 2** qualifies, then a **Bad Symbol** message is output.

Dimension 1

Definition: Checks symbol dimension for a specified number of pixels. In the case of rectangular symbols, checks the longer side.

Serial Cmd: <**K718**,finder pattern status,symbol size mode,symbol size 1,symbol size 2,symbol size tolerance,dimension mode,**dimension 1**,dimension 2,dimension tolerance,orientation mode,orientation value>

Default: **0**

Options: 0 to 2048 pixels

Dimension 2

Definition: Checks symbol dimension for a specified number of pixels. In the case of rectangular symbols, checks the shorter side.

Serial Cmd: <**K718**,finder pattern status,symbol size mode,symbol size 1,symbol size 2,symbol size tolerance,dimension mode,dimension 1,**dimension 2**,dimension tolerance,orientation mode,orientation value>

Default: **0**

Options: 0 to 1536 pixels

Dimension Tolerance

Definition: Sets the allowable deviation, in percentage, for symbol sizes specified in Dimension 1 and Dimension 2.

Serial Cmd: <**K718**,finder pattern status,symbol size mode,symbol size 1,symbol size 2,symbol size tolerance,dimension mode,dimension 1,dimension 2,**dimension tolerance**,orientation mode,orientation value>

Default: **10**

Options: 0 to 100

Orientation Mode

Definition: Sets the orientation value.

Serial Cmd: <**K718**,finder pattern status,symbol size mode,symbol size 1,symbol size 2,symbol size tolerance,dimension mode,dimension 1,dimension 2,dimension tolerance,**orientation mode**,orientation value>

Default: **Disabled**

Options: **0 = Disabled**
1 = Bad/No Symbol Output
2 = Object Qualification
3 = Enable Both

Disabled

Decoded messages are output, but no attempt is made to qualify symbols or to output **Bad Symbol** or **No Symbol** messages.

Bad/No Symbol Output

Checks first for decodes. If no symbol is decoded, checks for symbol orientation. If **Orientation Value** is satisfied, a **Bad Symbol** message is output. If not satisfied, a **No Symbol** message is output.

Object Qualification

Checks first for matches to symbol **Orientation Value**. If qualified, attempts to decode. If no decodes are found within the specified read cycle parameters, outputs a **No Read** message.

Enable Both

Same as **Object Qualification**, except that if **Orientation Value** is satisfied but the symbol is not decoded, then a **Bad Symbol** message is output; if **not** satisfied, a **Bad Symbol** message is still output.

Orientation Value

Usage: Instructs the imager to ignore symbols not in the specified orientation.

Definition: Sets the orientation of the symbol, in degrees clockwise from the default 0 orientation.

For Data Matrix symbols, sets the finder "L" pattern, with the example to the right showing the default 0 orientation.

For QR Code, sets the locator pattern (three squares), with the example to the right showing the default 0 orientation.

The other position settings will rotate clockwise from the defaults shown above.

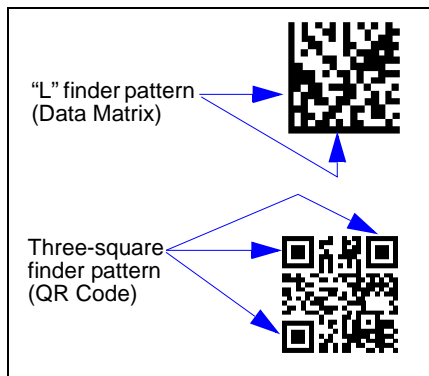

Serial Cmd: <K718,finder pattern status,symbol size mode,symbol size 1,symbol size 2,symbol size tolerance,dimension mode,dimension 1,dimension 2,dimension tolerance,orientation mode,**orientation value**>

Default: 0

Options: 0 to 359

Note: A symbol's orientation can miss the precise **Orientation Value** by several degrees and still be qualified. To be certain of the extent of the allowable tolerance, you should experiment with symbols in various orientations. In no case can they be more than 45° from the assigned orientation value and still be qualified.

Read Duration Output

Usage: Useful in evaluating actual read cycle timing results, especially when initially setting up an application to determine maximum line speed (obtainable based on spacing between symbols.)

Definition: When enabled the duration of the read cycle (in milliseconds) is appended to the symbol data.
The read duration is the time from the beginning of the read cycle until data is output.

Read Duration Output Mode

Serial Cmd: <K706,status,separator>

Default: Disabled

Options: 0 = Disabled 1 = Enabled

Important: To measure the entire read cycle when in **External Level** trigger mode, set **When to Output Symbol Data** to **End of Read Cycle**.

This output can measure over 49 days' worth of duration; if exceeded, the "OVERFLOW" message will be output in place of the duration.

Read Duration Output Separator

Definition: User defined character that separates the symbol information from the **Read Duration Output**.

Serial Cmd: <K706,status,separator>

Default: [space character]

Options: Any ASCII character.

Important: The ASCII characters <, >, and , can only be entered as hex pairs:

For <: <K706h,,3C>

For >: <K706h,,3E>

For , : <K706h,,2C>

See [ASCII Character Entry Modifier](#) on page 3-32 for a detailed explanation of how to enter ASCII characters as hex values.

Output Indicators

The **Quadrus MINI 3 Imager** has a beeper and three LED arrays, as follows:

1. A target pattern of blue LEDs for centering the field of view, which is projected from the front of the imager .
2. An array of green LEDs projected from the front of the imager that can be programmed to flash in response to user-defined conditions.
3. A row of five status LEDs on the side of the imager.

Green Flash Mode

Usage: Used as a visual verification that a good read has occurred.

Definition: An array of green LEDs in the front of the imager can be programmed to flash in response to user-defined conditions.

Serial Cmd: **<K750,green flash mode,target pattern status,green flash duration>**

Default: **Good Read**

Options:

- 0 = Disabled
- 1 = Good Read**
- 2 = Static Presentation
- 3 = Match
- 4 = Mismatch
- 5 = Strobe

Disabled

Green flash LEDs are disabled.

Good Read

Green flash LEDs will flash when a good read condition is met or when **Matchcode** is enabled and a match occurs.

Static Presentation Mode

Static Presentation Mode is used in conjunction with **Continuous Read Mode**: <K200,0>.

When operating in **Static Presentation Mode**, the red LEDs will illuminate while the imager is searching for a symbol in **Continuous Read Mode**. When a symbol is placed in the field of view and a good read occurs, the green LEDs will illuminate and stay on for the duration of time set in **Green Flash Duration**. Only one read will occur during that time unless more than one symbol is enabled in **Number of Symbols**.

Note: If **Static Presentation Mode** is selected but the imager is not in **Continuous Read**, the **Green Flash** will not occur.

To use Static Presentation:

1. Enable **Continuous Read**.
2. Select the number of symbols.
3. Enable **Static Presentation** in **Green Flash Mode**.
4. Select the read time in **Green Flash Duration**.

Match

The green LEDs will flash when a match condition is met. If multisymbol is enabled, then green flash LEDs will illuminate only if all symbols qualify as a match. If matchcode is disabled, then this mode will activate the LEDs on a good read.

Mismatch

Same as **Match**, except that LEDs will illuminate on a mismatch.

Strobe

Green flash LEDs will act as an illumination strobe for image capture. If it is required that the green flash LEDs be the *only* illumination for image capture, then the internal illumination LEDs can be disabled.

Target Pattern

- Usage:** Assists users in positioning and locating symbols in the center of the imager's field of view.
- Definition:** The user can control when the targeting system is ON or OFF, and can save this condition for power-on.
- Serial Cmd:** <K750,green flash mode,**target pattern status**,green flash duration>
- Default:** **Always ON**
- Options:**
- 0 = Always OFF
 - 1 = ON only when not in the read cycle
 - 2 = ON only when in the read cycle
 - 3 = Always ON**

Always OFF

The target pattern will remain OFF at all times unless overridden by the EZ Button or operational command.

ON Only When Not in the Read Cycle

The target pattern is always ON except during the read cycle. If the EZ Button or operational command overrides this setting, the target pattern will remain on at all times.

ON Only When in the Read Cycle

The target pattern will remain OFF except during the read cycle. If the EZ Button or operational command overrides this setting, the target pattern will remain on at all times.

Always ON

The target pattern is always ON.

Green Flash Duration

Usage: Provides visual verification that a good read has occurred.

Definition: When a good read occurs, the green LEDs will illuminate and stay on for the time set in the **Green Flash Duration** value.

Serial Cmd: <**K750**,green flash mode,target pattern status,**green flash duration**>

Default: **100** (1 second)

Options: 0 to 65535 (in 10 ms increments)

Beeper

Usage: An audible verification that either a good read or a No Read has occurred.

Definition: A beep is emitted after each good read or No Read.

Serial Cmd: <K702,beeper status>

Default: **Good Read**

Options: 0 = Disabled **1 = Good Read** 2 = No Read

Note: The beeper will also sound at any of the following times:

- When the imager is defaulted.
- When a send/save command is sent from **ESP**.
- At the conclusion of a calibration procedure.
- When a <Z>, <Zp>, <Zrd>, or <K701,,1> command is sent.

LED Configuration

Usage: Useful as a visible indicator of read rates and symbol quality.

Definition: Determines the mode in which the status LEDs operate.

Serial Cmd: <**K737,LED mode,ISO/IEC 16022 grade**>

Default: **Standard**

Options: **0 = Standard** 1 = ISO/IEC 16022 grade

In ISO/IEC 16022 grade mode the LEDs represent the grade of the first Data Matrix symbol decoded in the read cycle.

The parameter to be graded is set in the **ISO/IEC 16022 Grade** options.

For example, to program the LEDs to indicate the ISO/IEC 16022 print growth grade, set **LED Mode** to **ISO/IEC 16022 Grade** and set **ISO/IEC 16022 Grade** to **Print Growth**. If all the LEDs from 20% to 100% are illuminated, the read result is a grade A; if only the 20% LED is illuminated, the result is a grade F.

Standard

In **Standard Mode**, the STATUS LED indicates read cycle status and the GOOD READ LED illuminates upon a good read at the end of a read cycle. In a read rate test, these LEDs represent the percentage of good reads per images captured.

ISO/IEC 16022 Grade

Usage: Provides visual grading of specific ISO/IEC 16022 parameters.

Definition: Determines which ISO/IEC 16022 parameter the imager will grade via the LEDs.

Serial Cmd: <**K737,LED mode,ISO/IEC 16022 grade**>

Default: **Final Grade**

Options: **0 = Final Grade**
1 = Symbol Contrast
2 = Print Growth
3 = Axial Non-Uniformity
4 = Unused ECC

Serial Verification

Allows the user to verify configuration command status.

Serial Command Echo Status

Usage: This command is useful in removing any doubt about the imager's interpretation of any configuration command.

For example, if the current preamble is "SOM" and **<K701,1,START>** is entered, the imager will echo back **<K701,SOM>** since the attempted entry "START" exceeds the four character limit for that command. Therefore, it is rejected and the existing "SOM" message is echoed back and remains the preamble message.

Definition: When enabled, a configuration command received from the host is echoed back to the host with the resultant settings.

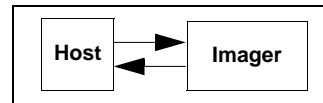

Function: If a command with multiple fields is processed, some of the fields may have been processed properly while others were not. The changes will appear in the string echoed back so that the user will know which fields did or did not change.

Serial Cmd: **<K701,serial command echo status,serial command beep status,control/hex output>**

Default: **Disabled**

Options: **0 = Disabled** 1 = Enabled

Serial Command Beep Status

Usage: Used to audibly verify the acceptance and validity of a command.

Definition: Causes the imager to beep once whenever a K command is entered to indicate that the command was accepted and processed.

Function: If an invalid command is entered, the imager beeps 5 times to indicate an invalid entry. However, this does not necessarily mean that all data fields have been entered incorrectly. Only one bad field needs to be found in order to activate the 5 beep response.

Serial Cmd: **<K701,serial command echo status,serial command beep status,control/hex output>**

Default: **Disabled**

Options: **0 = Disabled** 1 = Enabled

Control/Hex Output

Usage: Useful for viewing settings with binary characters when using serial commands on a terminal.

Definition: Determines the response to a **Serial Command Echo** or status request command.

When set to **Control**, two characters are transmitted to represent a non-displayable character. For example, a carriage return will be shown as: **^M**.

Serial Cmd: **<K701,serial command echo status,serial command beep status,control/hex output>**

Default: **Control**

Options: **0 = Control** 1 = Hex

EZ Button

The EZ Button has four positions, selectable by the length of time the button is held down, and indicated by one, two, three, and four beeps in succession. Each position can be programmed for any of eight options.

Definition: Serves as a master switch to enable/disable the EZ Button status.

Serial Cmd: **<K770,global status>**, default on power-on, load configuration database, save for power-on>

Default: **Enabled**

Options:

- 0 = Disabled
- 1 = Enabled**
- 2 = Trigger
- 3 = Unlatch Outputs
- 4 = Parameter Switch

Global Status

Disabled

When set to **Disabled**, the EZ Button does not function.

Enabled

When selected, the EZ Button is enabled and the function of each button position is selected by the **EZ Button Mode** command.

Trigger

When selected, the EZ Button acts as a trigger for the imager to start and end read cycles. All other button operations are inactive.

In External Level: The read cycle endures for as long as the EZ Button is pressed, unless a timeout occurs and **Timeout** is enabled for **End of Read Cycle**.

In External Edge: As with **Level**, **Edge** allows a read cycle to be initiated by pressing the EZ Button, but unlike **Level**, the read cycle ends with a good read output, a timeout, or a new trigger.

Unlatch Outputs

In this configuration, the EZ Button will unlatch any logic outputs that have been latched.

Parameter Switch

The parameter switch toggles between custom defaults and power-on settings. The condition is the same as that achieved by sending the **<Arc>** and **<Arp>** commands consecutively.

Default on Power-On

Definition: When enabled, if the EZ Button is held down on power-on the imager will default to customer defaults and save for power-on. This is the same as sending a **<Zrc>** command.

Serial Cmd: **<K770,global status,default on power-on,load configuration database,save for power-on>**

Default: **Enabled**

Options: 0 = Disabled **1 = Enabled**

Load Configuration Database

Definition: Allows the user to load the Configuration Database with calibration results. When the user performs a calibration using the EZ Button, all the database entries are moved down one index and the results of the calibration are saved to index 1. The results will be saved as current settings as well.

Serial Cmd: **<K770,global status,default on power-on,load configuration database,save for power-on>**

Default: **Enabled**

Options: 0 = Disabled **1 = Enabled**

Save for Power-On

Definition: If enabled, after calibration is complete, all parameters will be saved for power-on.

Serial Cmd: **<K770,global status,default on power-on,load configuration database,save for power-on>**

Default: **Disabled**

Options: **0 = Disabled** 1 = Enabled

EZ Button Modes

Usage: Useful for performing multiple, repetitive tasks at the work site.

Definition: Allows the user to program each of the EZ button's 4 positions from a selection of 8 modes.

Serial Cmd: `<K771,position 1 mode,position 2 mode,position 3 mode,position 4 mode>`

Options: 0 = Disabled 1 = Enabled

Single Beep	Two Beeps	Three Beeps	Four Beeps
0 = Disabled	0 = Disabled	0 = Disabled	0 = Disabled
1 = Read Rate	1 = Read Rate	1 = Read Rate	1 = Read Rate
2 = Calibrate	2 = Calibrate	2 = Calibrate	2 = Calibrate
3 = Save for Power-On	3 = Save for Power-On	3 = Save for Power-On	3 = Save for Power-On
4 = Unused	4 = Unused	4 = Unused	4 = Unused
5 = Load New Master	5 = Load New Master	5 = Load New Master	5 = Load New Master
6 = Unused	6 = Unused	6 = Unused	6 = Unused
7 = Target System	7 = Target System	7 = Target System	7 = Target System
8 = Bar Code Config.	8 = Bar Code Config.	8 = Bar Code Config.	8 = Bar Code Config.

Disabled

When set to disabled, the associated button position will have no function associated with it, and the position will be skipped over.

Read Rate

Read Rate will be initiated when the associated button position is selected. Read Rate will perform decodes/second and is the same as sending a `<C>` from the terminal. To exit Read Rate Mode quickly press and release the EZ button.

Calibrate

Calibration will be initiated when the associated button position is selected. To abort calibration, quickly press and release the EZ button.

Save for Power-On

All imager settings will be saved to non-volatile memory to be recalled on power-on whenever the associated button position is selected. This is the same as sending a `<Z>` from the terminal.

Load New Master

Functions in the same way as new master pin input whenever the associated button position is selected. The new master pin's **Consecutive Decode** requirement holds true for this function.

Target System

Turns on the target pattern whenever the associated button position is selected. To disable, quickly press and release the EZ button.

Note: This mode is the only one that does not require that the button be released before taking effect. Thus, as soon as the imager beeps the appropriate number of times for the position, it will take effect. If it is necessary to have the target system on before another operation such as calibration or read rate is performed, ensure that the target system mode is assigned a lower position so that it will be activated first.

Bar Code Configuration

Enables bar code configuration mode whenever the associated button position is selected. When enabled, the imager can accept configuration commands from symbols. To disable, quickly press and release the EZ button.

EZ Button Operation

To execute EZ button commands:

Single Beep (Position #1)

Hold down button until a single beep is heard (and the 20% LED illuminates).

Two Beeps (Position #2)

Hold down button until two quick beeps are heard (and the 20% and 40% LEDs illuminate.)

Three Beeps (Position #3)

Hold down button until three quick beeps are heard (and the 20%, 40%, and 60% LEDs illuminate).

Four Beeps (Position #4)

Hold down button until four quick beeps are heard (and the 20%, 40%, 60%, and 80% LEDs illuminate).

Configurable Output 1

[-] Output 1 Parameters	
[---] Output On	Trend Analysis
[---] Output State	Negative
[---] Pulse Width	5
[---] Output Mode	Pulse
[+] Trend Analysis	
[+] Symbol Quality (ISO/IEC 16022)	
[-] Diagnostics	

Usage: This option provides discrete signalling to host software to control external devices such as PLCs and relays. It is useful for routing, sorting, and to prevent mis-packaging and mis-routing.

Definition: Sets the discrete output functions for specific user-selected conditions. Allows the user to set the conditions under which an output (or outputs) will be activated.

Serial Cmd: `<K810,output on,output state,pulse width,output mode>`

Default: **Mismatch or No Read**

Options: **0 = Mismatch or No Read**

1 = Match or Good Read

2 = Mismatch

3 = No Read

4 = Trend Analysis

5 = Symbol Quality

6 = Diagnostic Warning

7 = In Read Cycle

Note: If **Output On** is set to **Match** or **Mismatch**, a transition (switching) will not occur unless **Matchcode Type** is enabled and a master symbol is loaded into memory.

Mismatch or No Read

Activates discrete output when the data does not match that of the master symbol or the symbol has not been decoded before the end of the read cycle.

Match or Good Read

Activates a discrete output when the symbol data matches the master symbol.

Note: If you want to output for a good read and **Matchcode** is not enabled, you can enable any output for **Match**.

Mismatch

Activates a discrete output whenever the symbol data does not match that of the master symbol.

No Read

Activates a discrete output whenever the symbol data is not decoded before the end of the read cycle.

Trend Analysis

Usage: Typically used when successful decodes are occurring but a discrete output is needed to flag a trend in quality issues.

Definition: Activates discrete output when a trend analysis condition is met, depending on the trend analysis option enabled.

Symbol Quality

Usage: Typically used when a discrete indication is needed to flag a symbol quality condition.

Definition: Activates discrete output when a symbol quality condition is met, depending on the symbol quality option enabled.

Diagnostic Warning

Usage: Typically used when a discrete indication of a diagnostic condition is needed.

Definition: Activates discrete output when a diagnostic warning condition is met, depending on the diagnostic option enabled.

In Read Cycle

Definition: Activates a discrete output when the imager is in a read cycle.

Output State

Definition: Sets the active electrical state of the discrete output.

Serial Cmd: <K810,output on,output state,pulse width,output mode>

Default: **Negative**

Options: **0 = Negative** 1 = Positive

Pulse Width

Definition: Sets the time in 10 ms increments that the discrete output remains active.

Serial Cmd: <K810,output on,output state,pulse width,output mode>

Default: **5** (Corresponds to 50 ms)

Options: 0 to 255 (0 to 2.55 seconds). Divide the number entered on the command line by 100 for time in seconds.

Output Mode

Definition: Sets the condition in which the discrete output is de-activated.

Serial Cmd: <K810,output on,output state,pulse width,output mode>

Default: **Pulse**

Options: **0 = Pulse**
2 = Latch Mode 2
3 = Latch Mode 3

Pulse

This is the default mode of operation in which the programmable output is activated when the **Output On** condition has been met and held active for the duration of the selected pulse width.

Latch Mode 2 (Unlatch Opposite Condition)

The programmable output is activated when the **Output On** condition has been met and held active until the opposite condition selected under **Output On** has been met.

For example, if **No Read** is enabled under **Output On**, the programmable output will go active on a No Read and remain active until the opposite condition, a good read, occurs.

Latch Mode 3 (Unlatch Re-enter Read Cycle)

The programmable output is active when the Output On condition has been met and is held active until a new read cycle begins.

Note: All of the **Output On** modes are inhibited when any **Output on Warning** is active for **Output 1**.

Trend Analysis Output 1

Note: **Output On** under **Output 1 Parameters** must be set to **Trend Analysis** for this output to function.



Under **Output 1 Parameters**, expand the **Trend Analysis** tree:

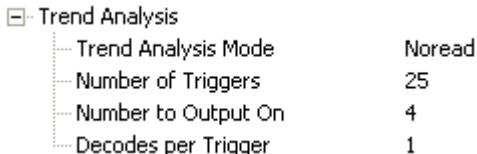

Usage: Useful in cases where the user doesn't want to shut down for one condition but wants to monitor quality and read conditions.

Definition: Applies **Trend Analysis** settings to **Output 1**.
With **Trend Analysis**, the user can track the occurrences and frequency of mismatches, No Reads, and the number of reads per trigger, and output the results to any of three outputs.

Example: *Trend Analysis Mode = No Read*
Trigger Evaluation Period= 25 triggers (read cycles)
Number to Output On = 4
In this example, the imager will activate an output when 4 No Reads occur within a period of 25 triggers (read cycles).

Trend Analysis Mode

Definition: Sets the trend condition (**Mismatch**, **No Read**, or **Decodes/Trigger**) that will activate the output.

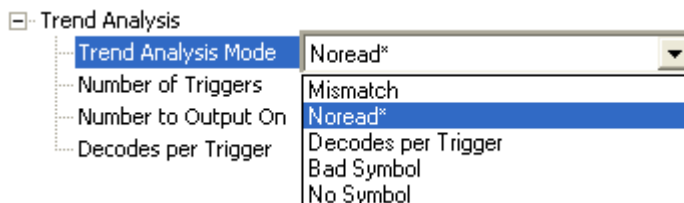

Serial Cmd: `<K780,trend analysis mode,trigger evaluation period,number to output on,decodes/trigger threshold>`

Default: **No Read**

Options:

- 0 = Mismatch
- 1 = No Read**
- 2 = Decodes/Trigger
- 3 = Bad Symbol
- 4 = No Symbol

Mismatch

Output will be activated when the number of mismatches equals the value entered for **Number to Output On** within the trigger window selected in **Number of Triggers**.

No Read

Output will be activated when the number of No Reads equals the value entered for **Number to Output On** within the trigger window selected in **Number of Triggers**.

Decodes/Trigger

Output will be activated when the number of decodes equals the value entered for **Number to Output On** within the trigger window selected in **Number of Triggers**.

Bad Symbol

Output will be activated when the number of **Bad Symbol** occurrences equals the value entered for **Number to Output On** within the trigger window selected in **Number of Triggers**.

Note: **Bad Symbol** output is not supported when **Q-Mode** is enabled. This also applies to **Trend Analysis Output 2** and **Trend Analysis Output 3**.

No Symbol

Output will be activated when the number of **No Symbol** occurrences equals the value entered for **Number to Output On** within the trigger window selected in **Number of Triggers**.

Note: **No Symbol** output is not supported when **Q-Mode** is enabled. This also applies to **Trend Analysis Output 2** and **Trend Analysis Output 3**.

Trigger Evaluation Period

- Definition:** The number of triggers to examine for the trend analysis condition.
- Serial Cmd:** <K780,trend analysis mode,trigger evaluation period,number to output on,decodes/trigger threshold>
- Default:** 0
- Options:** 0 to 255

Number to Output On

- Usage:** *Example:* If **Number to Output On** is set to 3 and **Trend Analysis Mode** is set to **No Read**, then the output will not be activated until 3 No Reads have occurred.
- Definition:** Sets the number of **Trend Analysis Mode** events (mismatches, No Reads, or reads/trigger as configured by **Trend Analysis Mode**) to occur within the trigger evaluation period before activating the associated output.
- Serial Cmd:** <K780,trend analysis mode,trigger evaluation period,number to output on,decodes/trigger threshold>
- Default:** 0
- Options:** 0 to 255

Decodes/Trigger Threshold

- Definition:** When set to this mode, and when the appropriate output is set to output on trend analysis, the imager will function in a **Decodes per Trigger** mode during the read cycle and the trend analysis operation. Output will be activated based on whether or not the symbol decode count at the end of the read cycle crosses the decodes per trigger threshold.
- Note:** Although this setup causes the imager to function in a **Decodes per Trigger** mode, the decode count will only be appended to the symbol data if the status of the **Decodes per Trigger** command is enabled.
- Serial Cmd:** <K780,trend analysis mode,trigger evaluation period,number to output on,decodes/trigger threshold>
- Default:** 0
- Options:** 0 to 65535

ISO/IEC 16022 Symbol Quality Output 1

Note: **Output On** under **Output 1 Parameters** must be set to **Symbol Quality** for this output to function.

Note: **ISO/IEC 16022 Symbol Quality Output 1** is not supported when **Q-Mode** is enabled.

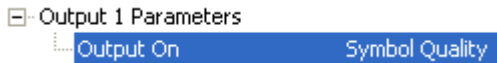

Under **Output 1 Parameters**, expand the **Symbol Quality (ISO/IEC 16022)** tree.

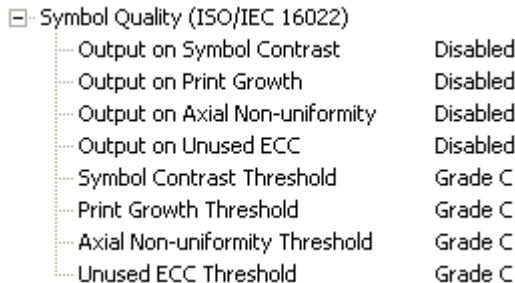

Output on Symbol Contrast

Usage: Lets the user know if symbol quality is less than acceptable.

Definition: If enabled, toggles Output 1 to an active state when **Symbol Contrast Threshold** is met.

Serial Cmd: `<K800,output on symbol contrast,symbol contrast threshold,output on print growth,print growth threshold,output on axial non-uniformity,axial non-uniformity threshold,output on UEC,UEC threshold>`

Default: **Disabled**

Options: **0 = Disabled** 1 = Enabled

Output on Print Growth

Usage: Lets the user know if symbol quality is less than acceptable.

Definition: If enabled, toggles **Output 1** to an active state when **Print Growth Threshold** is met.

Serial Cmd: `<K800,output on symbol contrast,symbol contrast threshold,output on print growth,print growth threshold,output on axial non-uniformity,axial non-uniformity threshold,output on UEC,UEC threshold>`

Default: **Disabled**

Options: **0 = Disabled** 1 = Enabled

Output on Axial Non-Uniformity

- Usage:** Lets the user know if symbol quality is less than acceptable.
- Definition:** If enabled, toggles **Output 1** to an active state when **Axial Non-Uniformity Threshold** is met.
- Serial Cmd:** <**K800**,output on symbol contrast,symbol contrast threshold,output on print growth,print growth threshold,**output on axial non-uniformity**,axial non-uniformity threshold,output on UEC,UEC threshold>
- Default:** **Disabled**
- Options:** **0 = Disabled** 1 = Enabled

Output on Unused Error Correction

- Usage:** Lets the user know if symbol quality is less than acceptable.
- Definition:** If enabled, toggles **Output 1** to an active state when **UEC Threshold** is met.
- Serial Cmd:** <**K800**,output on symbol contrast,symbol contrast threshold,output on print growth,print growth threshold,output on axial non-uniformity,axial non-uniformity threshold,**output on UEC**,UEC threshold>
- Default:** **Disabled**
- Options:** **0 = Disabled** 1 = Enabled

Symbol Contrast Threshold

- Usage:** Lets the user set the acceptable level of symbol quality.
- Definition:** Conforms to ISO/IEC 16022 symbol quality grading (A,B,C,D).
- Serial Cmd:** <**K800**,output on symbol contrast,**symbol contrast threshold**,output on print growth,print growth threshold,output on axial non-uniformity,axial non-uniformity threshold,output on UEC,UEC threshold>
- Default:** **Grade C**
- Options:** 0 = Grade A
1 = Grade B
2 = Grade C
3 = Grade D

Print Growth Threshold

- Usage:** Lets the user set the acceptable level of symbol quality.
- Definition:** Conforms to ISO/IEC 16022 symbol quality grading (A,B,C,D).
- Serial Cmd:** <**K800**,output on symbol contrast,symbol contrast threshold,output on print growth,**print growth threshold**,output on axial non-uniformity,axial non-uniformity threshold,output on UEC,UEC threshold>
- Default:** **Grade C**
- Options:** 0 = Grade A
1 = Grade B
2 = Grade C
3 = Grade D

Axial Non-Uniformity Threshold

- Usage:** Lets the user set the acceptable level of symbol quality.
- Definition:** Conforms to ISO/IEC 16022 symbol quality grading (A,B,C,D).
- Serial Cmd:** <**K800**,output on symbol contrast,symbol contrast threshold,output on print growth,print growth threshold,output on axial non-uniformity,**axial non- uniformity threshold**,output on UEC,UEC threshold>
- Default:** **Grade C**
- Options:** 0 = Grade A
1 = Grade B
2 = Grade C
3 = Grade D

Unused Error Correction Threshold

- Usage:** Lets the user set the acceptable level of symbol quality.
- Definition:** Conforms to ISO/IEC 16022 symbol quality grading (A,B,C,D).
- Serial Cmd:** <**K800**,output on symbol contrast,symbol contrast threshold,output on print growth,print growth threshold,output on axial non-uniformity,axial non-uniformity threshold,output on UEC,**UEC threshold**>
- Default:** **Grade C**
- Options:** 0 = Grade A
1 = Grade B
2 = Grade C
3 = Grade D

Diagnostics Output 1

Note: **Output On** under **Output 1 Parameters** must be set to **Diagnostic Warning** for this output to function.

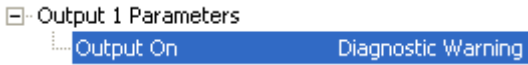

Under **Output 1 Parameters**, expand the **Diagnostics** tree.



Serial Cmd: <K790,unused 1,service unit>

Default: 0

Options: 0 = Disabled

Service Unit

When **Diagnostic Warning** is enabled, the **Output On** configuration has no effect. The output will remain active as long as one of the diagnostic warning conditions is met. The output will become inactive once it detects that there are no diagnostic warning conditions.

Definition: Allows the user to set up the output to toggle to active when the service timer has expired. This condition will only be held for one service timer click.

Note: This feature cannot be used if the imager is in a **Continuous Read** mode.

Serial Cmd: <K790,unused 1,service unit>

Default: 0

Options: 0 = Disabled 1 = Enabled

Configurable Output 2

Note: **Output 2** has the same parameters and default settings as **Output 1**.

[-] Output 2 Parameters	
Output On	Symbol Quality
Output State	Negative
Pulse Width	5
Output Mode	Pulse
[+] Trend Analysis	
[+] Symbol Quality (ISO/IEC 16022)	
[+] Diagnostics	

Serial Cmd: **<K811,output on,output state,pulse width,output mode>**

Trend Analysis Output 2

Note: **Output On** under **Output 2 Parameters** must be set to **Trend Analysis** for this output to function.

[-] Output 2 Parameters	
Output On	Trend Analysis

Serial Cmd: **<K781,trend analysis mode,trigger evaluation period,number to output on>**

ISO/IEC 16022 Symbol Quality Output 2

Note: **Output On** under **Output 2 Parameters** must be set to **Symbol Quality** for this output to function.

Note: **ISO/IEC 16022 Symbol Quality Output 2** is not supported when **Q-Mode** is enabled.

[-] Output 2 Parameters	
Output On	Symbol Quality

Serial Cmd: **<K801,output on symbol contrast,symbol contrast threshold,output on print growth,print growth threshold,output on axial non-uniformity,axial non-uniformity threshold,output on UEC,UEC threshold>**

Diagnostics Output 2

Note: **Output On** under **Output 2 Parameters** must be set to **Diagnostic Warning** for this output to function.

[-] Output 2 Parameters	
Output On	Diagnostic Warning

Serial Cmd: **<K791,unused 1,service unit>**

Configurable Output 3

Note: Output 3 has the same parameters and default settings as Output 1 and Output 2.

[-] Output 3 Parameters	
Output On	Mismatch or Noread
Output State	Negative
Pulse Width	5
Output Mode	Pulse
[+] Trend Analysis	
[+] Symbol Quality (ISO/IEC 16022)	
[+] Diagnostics	

Serial Cmd: <K812,output on,output state,pulse width,output mode>

Trend Analysis Output 3

Note: Output On under Output 3 Parameters must be set to Trend Analysis for this output to function.

[-] Output 3 Parameters	
Output On	Trend Analysis

Serial Cmd: <K782,trend analysis mode,trigger evaluation period,number to output on>

ISO/IEC 16022 Symbol Quality Output 3

Note: Output On under Output 3 Parameters must be set to Symbol Quality for this output to function.

Note: ISO/IEC 16022 Symbol Quality Output 3 is not supported when Q-Mode is enabled.

[-] Output 3 Parameters	
Output On	Symbol Quality

Serial Cmd: <K802,output on symbol contrast,symbol contrast threshold,output on print growth,print growth threshold,output on axial non-uniformity,axial non-uniformity threshold,output on UEC,UEC threshold>

Diagnostics Output 3

Note: Output On under Output 3 Parameters must be set to Diagnostic Warning for this output to function.

[-] Output 3 Parameters	
Output On	Diagnostic Warning

Serial Cmd: <K792,unused 1,service unit>

Power-On/Reset Counts

Note: **Power On/Reset Counts** is a read-only command.

Power-On

Serial Cmd: <K406,power-on,resets,power-on saves,power-on flash saves>

Power-On uses a 16-bit counter that increments each time the imager is powered-on.

Resets

Serial Cmd: <K406,power-on,resets,power-on saves,power-on flash saves>

Resets uses a 16-bit counter that increments each time the imager is reset. This value is reset at power-on.

Power-On Saves

Serial Cmd: <K406,power-on,resets,power-on saves,power-on flash saves>

Power-On Saves uses a 16-bit counter that increments each time an imager setting is saved for power-on with a <Z> command.

Power-On Flash Saves

Serial Cmd: <K406,power-on,resets,power-on saves,power-on flash saves>

Power-On Flash Saves uses a 16-bit counter that increments each time an imager setting is saved to the customer parameter section of flash memory with a <Zc> command.

Time Since Reset

Note: **Time Since Reset** is a read-only command.

Hours

Serial Cmd: <K407,hours,minutes>

Default: 16-bit counter (0 to 65535)

Hours uses a 16-bit counter that increments every 60 minutes.

Minutes

Serial Cmd: <K407,hours,minutes>

Default: 16-bit counter (0 to 60)

Minutes uses a 16-bit counter that increments every 60 seconds.

Note: Time counts are reset at power-on, but not with an <A> or <Z> command.

Service Message

When **Service Message** is enabled, a message of up to 10 ASCII characters is sent whenever the system detects that the service timer's limit has been reached. The service timer is reset at power-on, meaning that the service timer's limit is the amount of time since last reset. Service timer increments can be set in seconds or minutes.

Serial Cmd: <**K409,status,service message,threshold,resolution**>

Default: **0**

Options: **0 = Disabled** 1 = Enabled

Service Message

Serial Cmd: <**K409,status,service message,threshold,resolution**>

Default: **SERVICE**

Options: An ASCII string between 1 and 10 characters.

Important: The ASCII characters <, >, and , can only be entered as hex pairs:

For <: <**K409h,,3C**>

For >: <**K409h,,3E**>

For , : <**K409h,,2C**>

See [ASCII Character Entry Modifier](#) on page 3-32 for a detailed explanation of how to enter ASCII characters as hex values.

Threshold

Serial Cmd: <**K409,status,service message,threshold,resolution**>

Default: **300** (5 minutes)

Options: 1 to 65535

Resolution

Serial Cmd: <**K409,status,service message,threshold,resolution**>

Default: **Seconds**

Options: **0 = Seconds** 1 = Minutes

Frame Information

Output Frame Number

Serial Cmd: <K734,output frame number,output coordinates>

Default: **Disabled**

Options: **0 = Disabled**
1 = Enabled

Disabled

When **Output Frame Number** is set to **Disabled**, the frame number is not output as part of the symbol data.

Enabled

When **Output Frame Number** is set to **Enabled**, the number of the frame in which the symbol was first decoded is attached to the symbol output information. The output format is "Fnnn", where "nnn" is a 3-digit decimal value from 0 to 255. The frame number rolls over to 0 once it passes 255.

If this feature is enabled, the frame information will follow the symbol data, and it will precede any symbol quality data (if symbol quality settings are enabled-- see [Symbol Quality Separator](#) on page 8-8). The symbol quality separator is located between the end of the already-formatted data and the "F" that precedes the frame number.

Output Coordinates

Serial Cmd: <K734,output frame number,output coordinates>

Default: **Disabled**

Options: **0 = Disabled**
1 = Enabled

Disabled

When **Output Coordinates** is set to **Disabled**, the coordinates are not output as part of the symbol data.

Enabled

When **Output Coordinates** is set to **Enabled**, the four sets of object coordinates for the first successfully decoded symbol are attached to the symbol data output in the following format:

"(nnn,mmm)", where "nnn" is a 3-digit X-coordinate and "mmm" is a 3-digit Y-coordinate. The validation separator is located between the end of the already formatted data and the first coordinate point. The point with the lowest X + Y sum will be output first, followed by the next three points in a clockwise direction.

Example:

(032,040)(287,056)(287,279)(048,271)

Image Output

Usage: This feature allows the user to select what read cycle condition triggers the image file output.

Definition: Used to output an image file when a specified read cycle condition has been met, such as No Read or Good Read. When the read cycle is complete, the normal read cycle output will occur, including any configured postamble or preamble data. The read cycle will check if image output is enabled, and if the specified read cycle condition has been met. If both these conditions are true, the image file will be output to the user-specified communication port in the user-specified image file format.

Serial Cmd: <**K739,image output mode**,communication port,file format,JPEG quality>

Default: **Disabled**

Options: **0 = Disabled**
 1 = Good Read
 2 = No Read
 3 = No Read or Good Read
 4 = Mismatch

Good Read

If a Good Read condition is met during the read cycle, the image file corresponding with the first Good Read will be output. The image file will immediately follow the read cycle output and postambles. For a Good Read condition to occur, all symbols in the read cycle must qualify.

No Read

If a No Read condition occurs during the read cycle, the image file corresponding with the first No Read will output. The image file will immediately follow the read cycle output and postambles. There are conditions in which the read cycle may have a No Read condition but the image will *not* be output. For example, if the read cycle is looking for two No Read symbols in the same image capture but one is a Good Read, the image will not be output, because it is not considered a No Read image.

No Read or Good Read

If a No Read condition or a Good Read condition occurs, the first image of either kind will be output.

Mismatch

If a Good Read occurs during the read cycle but the image is a Mismatch condition, the first Mismatch image will be output.

Communication Port

Definition: This setting selects the communication port through which the image file will be transferred to the host.

Serial Cmd: <K739,image output mode,**communication port**,file format,JPEG quality>

Default: Host

Options: 0 = Host 1 = Auxiliary 2 = USB

File Format

Definition: This setting selects the format of the image file to be output.

Note: If JPEG is the chosen image file format, the resolution of the image will be determined by the setting in the **JPEG Quality** field.

Serial Cmd: <K739,image output mode,communication port,**file format**,JPEG quality>

Default: JPEG

Options: 0 = Bitmap 1 = JPEG 2 = Binary

JPEG Quality

Definition: This setting determines the quality of JPEG image compression. The user may select a value from 1 (lowest) to 100 (highest).

Serial Cmd: <K739,image output mode,communication port,file format,**JPEG quality**>

Default: 90

Options: 1 to 100 (percent)

Image Output Example

The following example assumes that the imager is set to output on No Read, and that it is in a rapid capture mode of 3 captures.

<i>Number of Symbols:</i>	1
<i>Frame # 1:</i>	No Read
<i>Frame # 2:</i>	No Read
<i>Frame # 3:</i>	No Read
<i>Read Cycle Result:</i>	No Read
<i>Output Frame:</i>	Frame # 1
<i>Number of Symbols:</i>	1
<i>Frame # 1:</i>	No Read
<i>Frame # 2:</i>	No Read
<i>Frame # 3:</i>	Good Read
<i>Read Cycle Result:</i>	Good Read
<i>Output Frame:</i>	None
<i>Number of Symbols:</i>	2
<i>Frame # 1:</i>	No Read
<i>Frame # 2:</i>	No Read
<i>Frame # 3:</i>	Good Read, Symbol # 1
<i>Read Cycle Result:</i>	No Read
<i>Output Frame:</i>	Frame # 1

Database Identifier Output

Usage: Useful in keeping track of which database entries read which symbols.
Serial Cmd: **<K759,status,separator>**
Default: **0**
Options: **0 = Disabled** 1 = Enabled

Output Status

Disabled

When this command is disabled, no database identifier information will be output.

Enabled

When this command is enabled, the imager will append a two-digit number and the characters “DB” to the data output following the separator for each symbol decoded using **Configuration Database**. For example, if the separator is an underscore character and the second database entry reads a symbol encoded with “data capture” during the read cycle, the symbol data output will be “data capture_DB02”. If the database is not active, no identifiers will be attached to output.

Separator

Usage: The separator character separates the symbol data from the database identifier.
Serial Cmd: **<K759,status,separator>**
Default: **<space>**
Options: Any ASCII character.

Important: The ASCII characters **<**, **>**, and **,** can only be entered as hex pairs:

For **<**: **<K759h,,3C>**

For **>**: **<K759h,,3E>**

For **,**: **<K759h,,2C>**

See [ASCII Character Entry Modifier](#) on page 3-32 for a detailed explanation of how to enter ASCII characters as hex values.

Quality Output

Separator

Definition: The separator character separates quality output data from symbol data.

Serial Cmd: <K704,separator,decodes/trigger status>

Default: ,

Options: Any ASCII character.

Important: The ASCII characters <, >, and , can only be entered as hex pairs:

For <: <K704h,3C>

For >: <K704h,3E>

For , : <K704h,2C>

See [ASCII Character Entry Modifier](#) on page 3-32 for a detailed explanation of how to enter ASCII characters as hex values.

Decodes per Trigger Status

Definition: When this feature is enabled, the imager enters a state where it processes frames as configured until the end of a read cycle, with or without a successful symbol decode. When the read cycle ends, the imager outputs any decoded symbol data along with the decodes per trigger count.

Serial Cmd: <K704,separator,decodes/trigger status>

Default: 0

Options: 0 = Disabled 1 = Enabled

Configuring EZ Trax Output

After you have set up your imager for **EZ Trax**, you can configure the software in three different ways: using the **EZ Trax** interface, using the tree controls in **ESP**, and using serial commands.

For detailed information about how to use the **EZ Trax** user interface for configuration, refer to the Help menu in EZ Trax software, or the *EZ Trax Quick Start Guide*, available on the Microscan Tools CD.

Configuring EZ Trax Output by ESP

To configure **EZ Trax** using **ESP**, first click the **I/O** button in **App Mode** to display the I/O Parameters tree control.

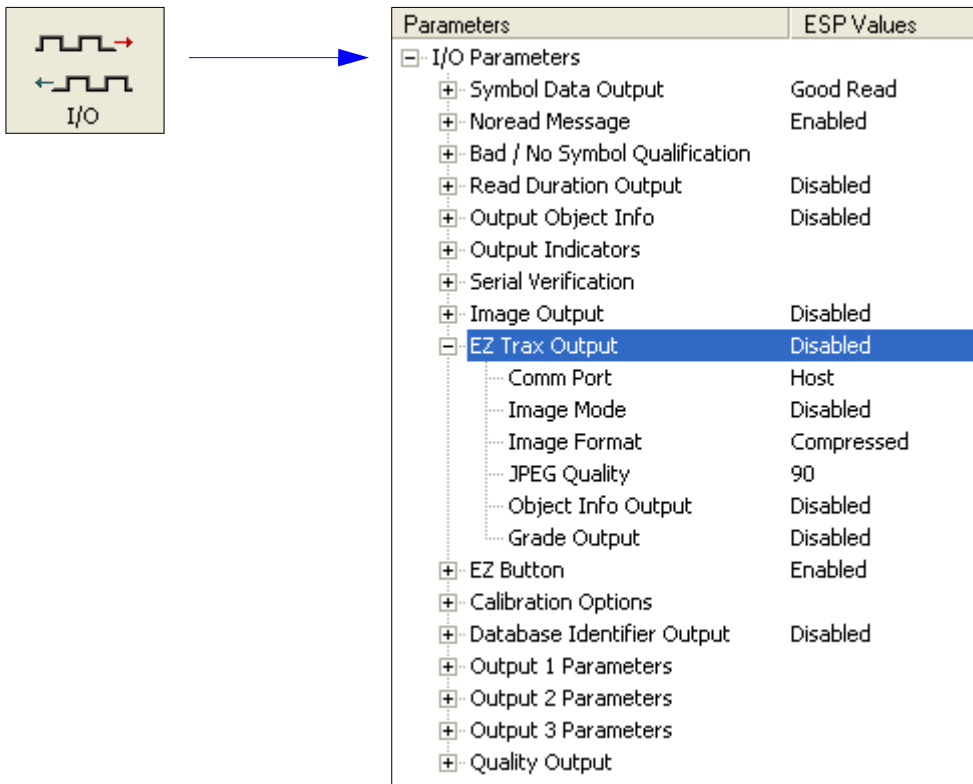

Parameters	ESP Values
[-] I/O Parameters	
[+] Symbol Data Output	Good Read
[+] Noread Message	Enabled
[+] Bad / No Symbol Qualification	
[+] Read Duration Output	Disabled
[+] Output Object Info	Disabled
[+] Output Indicators	
[+] Serial Verification	
[+] Image Output	Disabled
[-] EZ Trax Output	Disabled
--- Comm Port	Host
--- Image Mode	Disabled
--- Image Format	Compressed
--- JPEG Quality	90
--- Object Info Output	Disabled
--- Grade Output	Disabled
[+] EZ Button	Enabled
[+] Calibration Options	
[+] Database Identifier Output	Disabled
[+] Output 1 Parameters	
[+] Output 2 Parameters	
[+] Output 3 Parameters	
[+] Quality Output	

EZ Trax Output

[-] EZ Trax Output	Enabled
Comm Port	Disabled*
Image Mode	Enabled
Image Format	Compressed
JPEG Quality	90
Object Info Output	Disabled
Grade Output	Disabled

When EZ Trax output is enabled, the imager will attempt to output all enabled EZ Trax options. EZ Trax will not function unless enabled.

Comm Port

[-] EZ Trax Output	Disabled
Comm Port	Host*
Image Mode	Host*
Image Format	Aux
JPEG Quality	USB
Object Info Output	Disabled
Grade Output	Disabled

Selects the communication port that will be used to transfer image files.

Image Mode

[-] EZ Trax Output	Disabled
Comm Port	Host
Image Mode	Both Noread and Good Read
Image Format	Disabled*
JPEG Quality	Good Read
Object Info Output	Noread
Grade Output	Both Noread and Good Read
	Mismatch

Determines which read cycle condition triggers image file output.

Image Format

[-] EZ Trax Output	Enabled
Comm Port	Host
Image Mode	Disabled
Image Format	Compressed*
JPEG Quality	Lossless
Object Info Output	Compressed*
Grade Output	Disabled

Selects the format of the image output file.

JPEG Quality

<input checked="" type="checkbox"/> EZ Trax Output	Enabled
Comm Port	Host
Image Mode	Disabled
Image Format	Compressed
JPEG Quality	90 <input type="text"/> (1 - 100) %
Object Info Output	Disabled
Grade Output	Disabled

Sets the amount of JPEG image compression. A value of **1** represents the highest compression and lowest image quality, and **100** represents the lowest compression and highest image quality.

Object Info Output

<input checked="" type="checkbox"/> EZ Trax Output	Enabled
Comm Port	Host
Image Mode	Disabled
Image Format	Compressed
JPEG Quality	90
Object Info Output	Disabled* <input type="button" value="v"/>
Grade Output	Disabled*
	Enabled

If a symbol is decoded during an image capture, the symbol type and other supplementary symbol information is also included.

Grade Output

<input checked="" type="checkbox"/> EZ Trax Output	Enabled
Comm Port	Host
Image Mode	Disabled
Image Format	Compressed
JPEG Quality	90
Object Info Output	Disabled
Grade Output	Disabled* <input type="button" value="v"/>
	Disabled*
	Enabled

Symbol quality information will be output in the form of an abbreviated identifier for each read cycle.

Configuring EZ Trax Output by Serial Command

Usage: Useful for when you want to configure EZ Trax output using serial commands instead of the EZ Trax graphic interface.

Definition: When EZ Trax output is enabled, the imager will attempt to output all enabled EZ Trax options. EZ Trax will not function unless enabled.

Serial Cmd: <**K757,status,comm port,image mode,image format,JPEG quality,object info output, grade output**>

Default: **Disabled**

Options: **0 = Disabled** 1 = Enabled

Comm Port

Definition: Selects the communication port that will be used to transfer image files.

Serial Cmd: <**K757,status,comm port,image mode,image format,JPEG quality,object info output, grade output**>

Default: **Host**

Options: **0 = Host** 1 = Aux 2 = USB

Host Port

Sends output using the current Host Port.

Aux Port

Sends output using the Auxiliary Port.

USB

Sends output using a USB connection.

Image Mode

Definition: Determines which read cycle condition triggers image file output.

Serial Cmd: <**K757,status,comm port,image mode,image format,JPEG quality,object info output,grade output**>

Default: **Disabled**

Options: **0 = Disabled**
 1 = Good Read
 2 = No Read
 3 = No Read and Good Read
 4 = Mismatch

Good Read

Outputs the first Good Read image in the read cycle. The image file will immediately follow the symbol data.

No Read

Outputs the first No Read image in the read cycle. The image file will immediately follow the symbol data.

Note: If two symbols are present in the same image capture and one of them is successfully decoded, no image will be output.

No Read and Good Read

Outputs the first No Read or Good Read image in the read cycle.

Mismatch

Outputs the image of the first mismatch condition.

Image Format

Definition: Selects the format of the image output file.

Serial Cmd: <**K757**,status,comm port,image mode,**image format**,JPEG quality,object info output, grade output>

Default: **Compressed**

Options: 0 = Lossless **1 = Compressed**

Lossless

A "lossless" image is one that is in a high resolution format, and that will not lose resolution even when manipulated and saved multiple times. When Lossless is enabled, the JPEG Quality setting has no effect.

Compressed

Outputs the image in JPEG format. Image quality is determined by the JPEG Quality setting.

JPEG Quality

Definition: Sets the amount of JPEG image compression. A value of **1** represents the highest compression and lowest image quality, and **100** represents the lowest compression and highest image quality.

Serial Cmd: <**K757**,status,comm port,image mode,image format,**JPEG quality**,object info output, grade output>

Default: **90**

Options: 1 to 100 (percent)

Object Info Output

Definition: If a symbol is decoded during an image capture, the symbol type and other supplementary symbol information is also included.

Serial Cmd: <**K757**,comm port,image mode,image format,JPEG quality,**object info output**,grade output>

Default: **Disabled**

Options: **0 = Disabled** 1 = Enabled

Grade Output

Definition: Symbol quality information will be output in the form of an abbreviated identifier for each read cycle.

Serial Cmd: <**K757**,comm port,image mode,image format,JPEG quality,**object info output**,**grade output**>

Default: **Disabled**

Options: **0 = Disabled** 1 = Enabled

8 *Symbol Quality*

Contents

Symbol Quality Serial Commands	8-2
Overview of Symbol Quality.....	8-3
Symbol Quality by ESP.....	8-4
Symbol Quality Separator/Data Matrix Output Mode.....	8-8
ISO/IEC 16022 Symbol Quality Output.....	8-10
ISO/IEC 16022 Symbol Quality Output by ESP.....	8-12
Microscan Symbol Quality Output	8-13
Microscan Symbol Quality Output by ESP	8-16

This section describes parameters that, when enabled, will output detailed symbol quality evaluations.

Important: **Symbol Quality** output is not supported when **Q-Mode** is enabled.

Symbol Quality Serial Commands

Symbol Quality Separator/ Data Matrix Output Mode	< K708 ,symbol quality separator,data matrix output mode>
ISO/IEC 16022 Symbol Quality Output	< K709 ,symbol contrast,print growth,axial non-uniformity,unused ECC>
Microscan Symbol Quality Output	< K710 ,percent cell damage,total read time,capture time,locate time,decode time,pixels per element,ECC level,matrix size,quiet zone,symbol angle>
Static Validation Report	< VAL >

Overview of Symbol Quality

Information about symbol quality and timing can be appended to symbol data by enabling specific evaluation parameters. The order in which these values are appended corresponds directly to the order in which they appear in **ESP's Symbol Quality** tree control.

Symbol Quality parameters are separated into ISO/IEC 16022 Symbol Quality Output and Microscan Symbol Quality Output.

Total Read Time, Symbol Quality Separator, and Output Mode are common to both ISO/IEC 16022 and Microscan Grading Parameters.

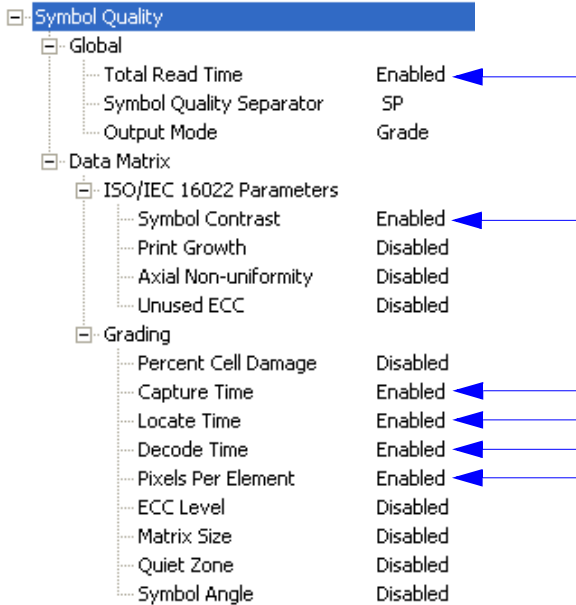

The enabled **Symbol Quality** parameters are appended to symbol data output in the order that they appear in the tree control.

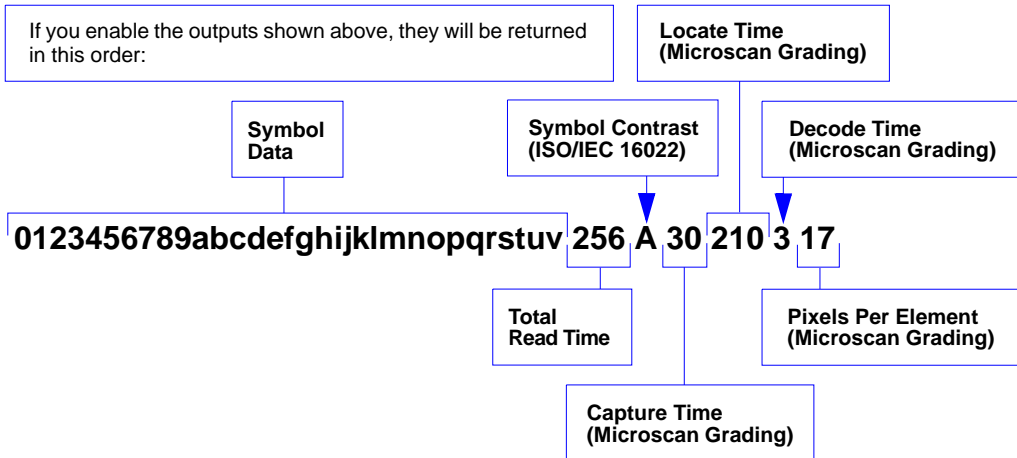

Symbol Quality by ESP

Tree Control



Click this button to bring up the **App Mode** view.



Click this button to bring up the **Symbol Quality** tree control.

Parameters	ESP Values
[-] Symbol Quality	
[-] Global	
[-] Data Matrix	
[-] ISO/IEC 16022 Parameters	
Symbol Contrast	Disabled
Print Growth	Disabled
Axial Non-uniformity	Disabled
Unused ECC	Disabled
[-] Grading	
Percent Cell Damage	Disabled
Capture Time	Disabled
Locate Time	Disabled
Decode Time	Disabled
Pixels Per Element	Disabled
ECC Level	Disabled
Matrix Size	Disabled
Quiet Zone	Disabled
Symbol Angle	Disabled*
	Disabled*
	Enabled

To open nested options, **single-click** the +.

To change a setting, **double-click** the setting and use your cursor to scroll through the options.

Report Tab

The **Report** tab allows the user to initiate **Data Matrix Grading** and to generate and save grading reports.

To save the report as a PDF file, an HTML file, a CSV file, or an RTF file, click the **Save Report** button.

Reports appear in the viewing area underneath the **Data Matrix Grading** and **Save Report** buttons.

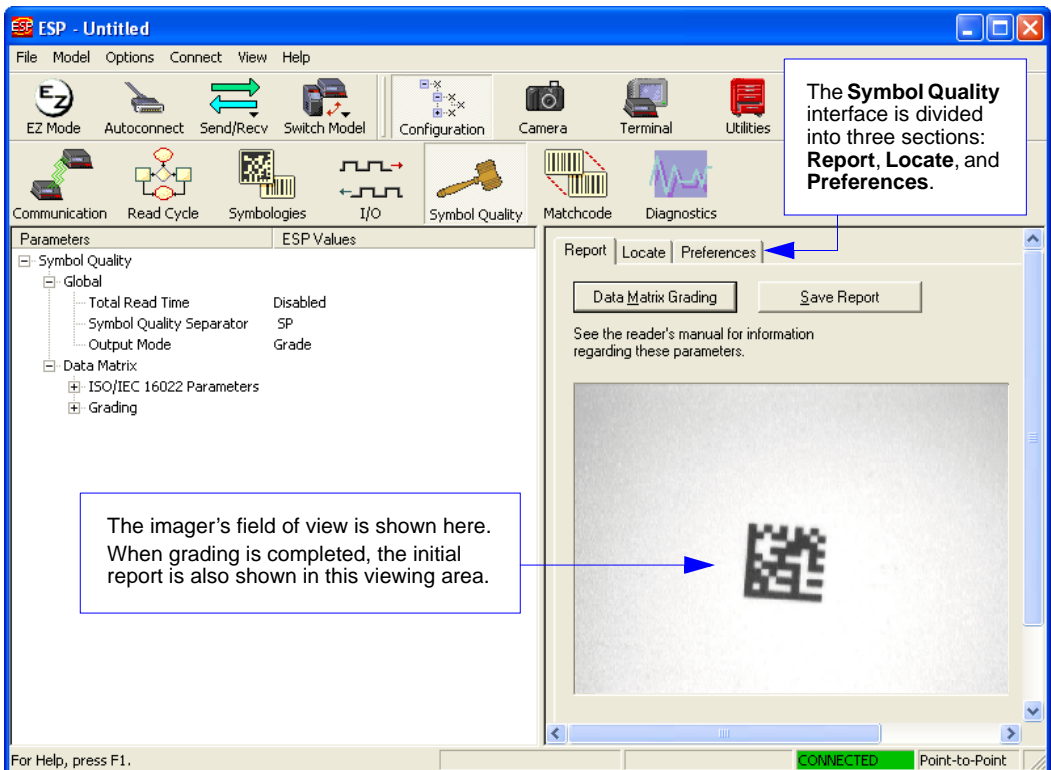

Locate Tab

The **Locate** tab allows the user to determine the position of the symbol within the imager's field of view, and to optimize the imager's camera settings for symbol quality evaluation.

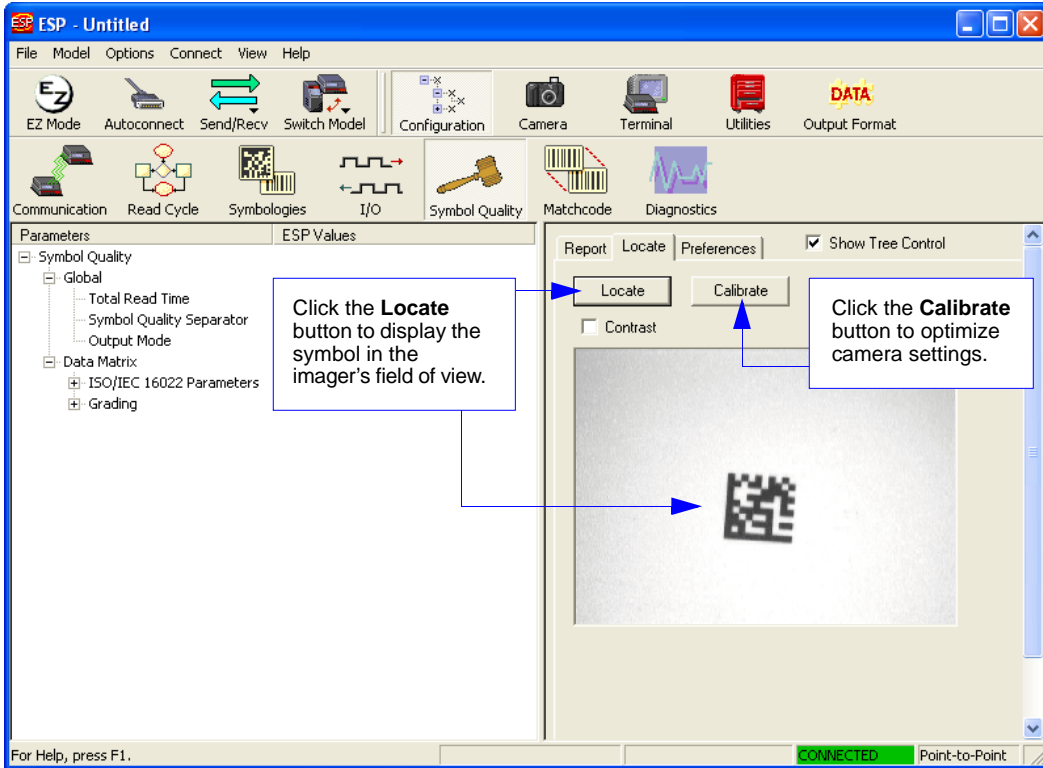

Preferences Tab

The **Preferences** tab allows the user to set defaults that are automatically activated when grading is completed. For this reason, the user is advised to set preferences before performing grading.

The screenshot shows the Preferences dialog box with the following sections and callouts:

- Report | Locate | Preferences | Show Tree Control** (checked)
- Fields for report:**
 - Operator Name: J. Doe (Callout: This information is appended at the bottom of the report.)
 - Company Name: XYZ Corp.
- Saved Options:**
 - Show Report Options dialog during 'Save Report'.
 - Default Report Type: PDF Files (*.pdf) (Callout: Choose the default report type to be generated when you click **Save Report** on the **Report** tab. Check **Autofit Content** to ensure that saved PDF report content will fit on a single page.)
 - Autofit Content
 - Low Graphic HTML
 - Append to file
 - Store Report without file path prompt (Callout: Typically you will be asked where you wish to store your report. If you do not want to be prompted to choose a file path, click **Store Report without file path prompt**.)
 - Use symbol data for file name
 - Default Path: C:\Documents and Settings\symbol grades
 - Automatically open generated report
 - Print after saving
 - Include Image (Callout: Click the **Include Image** check box to output the captured symbol image with your saved report as a Bitmap or JPEG image file.)
 - Bitmap
 - JPEG
 - JPEG Image Quality: 100 (range 1 - 100)
- Overall Grade Based On:**
 - Symbol Contrast
 - Print Growth
 - Axial Nonuniformity
 - Unused ECC
 - Enable UII Parsing (Callout: Enables ESP to parse UII symbol data into the correct fields and output order defined by the U.S. Department of Defense IUID initiative.)
- Buttons:**
 - Default Settings (Callout: Returns all settings to default.)
 - Revert Settings (Callout: Returns all settings to most recent.)

Symbol Quality Separator/Data Matrix Output Mode

Symbol Quality Separator applies to both Symbol Quality groups: ISO/IEC 16022 Symbol Quality Output and Microscan Symbol Quality Output.

Symbol Quality Separator

Definition: Inserts a separator between each enabled field of the symbol quality output.

Serial Cmd: `<K708,symbol quality separator,output mode>`

Default: `<SP>` (space character)

Options: Any ASCII character.

Important: The ASCII characters `<`, `>`, and `,` can only be entered as hex pairs:

For `<`: `<K708h,3C>`

For `>`: `<K708h,3E>`

For `,`: `<K708h,2C>`

See [ASCII Character Entry Modifier](#) on page 3-32 for a detailed explanation of how to enter ASCII characters as hex values.

Symbol Quality Separator by ESP

The screenshot shows a configuration window with two panes. The top pane, titled 'Parameters', shows a tree view with 'Symbol Quality' expanded to 'Global'. The 'Symbol Quality Separator' is highlighted, showing a value of 'SP'. The bottom pane shows a more detailed tree view including 'Data Matrix' parameters. A callout box points to the 'SP' value in the top pane, stating: 'When you double-click on the default separator SP, the Symbol Quality Separator Calculator appears. Use the calculator keypad for one-click separator configuration.' Below the callout is a keypad with characters: NUL, SOH, STX, ETX, EOT, ENQ, ACK, BEL, BS, HT, LF, VT, FF, CR, SO, SI, DLE, DC1, DC2, DC3, DC4, NAK, SYN, ETB, CAN, EM, SUB, ESC, FS, GS, RS, US, SP. A note at the bottom of the keypad says 'Click 'Delete' to remove characters.'

Data Matrix Output Mode

Note: Output Mode applies to ISO/IEC 16022 symbol quality parameters.

Definition: Output Mode specifies how the four output parameters, if enabled, are formatted.

Serial Cmd: <K708,symbol quality separator,**output mode**>

Default: **Grade**

Options: **0 = Grade** 1 = Value

Grade

If in **Grade Mode**, a grade (A,B,C,D) is appended to the symbol data.

Value

If in **Value Mode**, the calculated value for the given parameter is appended to the symbol data.

ISO/IEC 16022 Symbol Quality Output

Symbol Quality Parameters for Data Matrix symbols specified by ISO/IEC 16022.

Symbol Contrast

Usage: Lets the user know if contrast settings are less than acceptable.
Definition: All the pixels that fall within the area of the test symbol, including its required zone, will be sorted by their reflectance values to select the darkest 10% and the lightest 10% of the pixels. The arithmetic mean of the darkest and the lightest pixels is calculated and the difference of the two means is the Symbol Contrast.

(ANSI) Symbol Contrast grading is defined this way:

- A (4.0) if $SC > 70\%$
- B (3.0) if $SC > 55\%$
- C (2.0) if $SC > 40\%$
- D (1.0) if $SC > 20\%$
- F (0.0) if $SC < 20\%$

If enabled, the symbol contrast is appended to the symbol data according to the **ISO/IEC 16022 Symbol Quality Output Mode** setting.

Serial Cmd: <K709,symbol contrast,print growth,axial non-uniformity,UEC>

Default: Disabled

Options: 0 = Disabled 1 = Enabled

Print Growth

Note: Print Growth is not supported when **Q-Mode** is enabled.

Definition: The extent to which dark or light markings appropriately fill or exceed their module boundaries. These values are determined by counting pixels in the clock pattern of the binary digitized image, then comparing it to a nominal value and minimum and maximum values. The print growth grade is defined in this way:

- A (4.0) if $-0.050 < PG < 0.50$
- B (3.0) if $-0.070 < PG < 0.70$
- C (2.0) if $-0.085 < PG < 0.85$
- D (1.0) if $-0.10 < PG < 1.00$
- F (0.0) if $PG < -1.00$ or $PG > 1.00$

If enabled, the print growth is appended to the symbol data according to the **ISO/IEC 16022 Symbol Quality Output Mode** setting.

Serial Cmd: <K709,symbol contrast,print growth,axial non-uniformity,UEC>

Default: Disabled

Options: 0 = Disabled 1 = Enabled

Axial Non-Uniformity (Data Matrix Only)

Note: Axial Non-Uniformity is not supported when **Q-Mode** is enabled.

Definition: Axial non-uniformity is a measure of how much the sampling point spacing differs from one axis to another, namely $AN = \text{abs}(XAVG - YAVG) / ((XAVG + YAVG)/2)$ where $\text{abs}()$ yields the absolute value. If a symbology has more than two major axes, then AN is computed for those two average spacings which differ the most. (ANSI) axial non-uniformity grading is defined this way:

A (4.0) if $AN < .06$

B (2.0) if $AN < .08$

C (2.0) if $AN < .10$

D (1.0) if $AN < .12$

F (0.0) if $AN > .12$

If enabled, the axial non-uniformity is appended to the symbol data according the **ISO/IEC 16022 Symbol Quality Output Mode** setting.

Serial Cmd: <K709,symbol contrast,print growth,**axial non-uniformity**,UEC>

Default: **Disabled**

Options: **0 = Disabled** 1 = Enabled

Unused Error Correction (Data Matrix Only)

Note: Unused Error Correction is not supported when **Q-Mode** is enabled.

Definition: The correction capacity of Reed-Solomon decoding is expressed in the equation: $e + 2d < d - p$, where e is the number of erasures, d is the number of error correction code words, and p is the number of code words reserved for error detection.

A (4.0) if $UEC > .62$

B (3.0) if $UEC > .50$

C (2.0) if $UEC > .37$

D (1.0) if $UEC > .25$

F (0.0) if $UEC < .25$

If enabled, the UEC is appended to the symbol data according to the **ISO/IEC 16022 Symbol Quality Output Mode** setting.

Serial Cmd: <K709,symbol contrast,print growth,**axial non-uniformity**,**UEC**>

Default: **Disabled**

Options: **0 = Disabled** 1 = Enabled

ISO/IEC 16022 Symbol Quality Output by ESP

ESP's **Symbol Quality** interface allows you to evaluate Data Matrix symbols for compliance with ISO/IEC 16022 requirements.

First, determine which ISO/IEC 16022 Parameters you need to evaluate, using the **Symbol Quality** tree control.

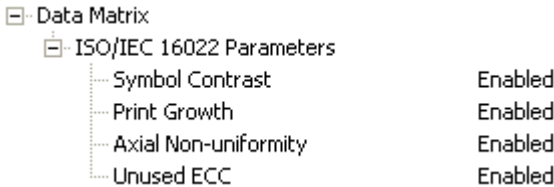

Once you have set these Data Matrix evaluation parameters, go to the **Preferences Tab** and set your Data Matrix Grading Report output preferences.



After your output preferences are set, click the **Data Matrix Grading** button.



There will be a wait of a few seconds, and then the evaluation results will appear in the **Symbol Quality** view, in a format similar to the one shown below.

Data Matrix Grading Report						GRADE
ISO/IEC 16022:	Symbol Contrast	= 80 %				A
	Print Growth	= 0.26	Dx - 54 %	Dnom - 50 %	Dmax - 65 %	A
			Dy - 54 %	Dmin - 35 %		
	Axial Nonuniformity	= 0.00	Xavg - 13.2			A
	Unused ECC	= 100 %	Yavg - 13.1			A
			Eact - 0			
			Emax - 10			
GRADING:	% Cell Damage	= 0 %				
	Total Read Time	= 99 ms				
	Capture Time	= 65 ms				
	Locate Time	= 27 ms				
	Decode Time	= 7 ms				
	Pixels/Element	= 13.1				
	ECC Level	= 200				
	Matrix Size	= 14x14				
	Quiet Zone	= PASS				

If you want to view the results in a report format, click the **Save Report** button. The report will be output in the format you chose in the **Preferences** dialog.



Microscan Symbol Quality Output

Percent Cell Damage (Data Matrix Only)

Note: Percent Cell Damage is not supported when Q-Mode is enabled.

Definition: When this feature is enabled, the cell damage percentage is appended to data output.

Serial Cmd: <K710,percent cell damage,total read time,capture time,locate time,decode time,pixels per element,ECC level,matrix size,quiet zone,symbol angle>

Default: Disabled

Options: 0 = Disabled 1 = Enabled

Total Read Time

Definition: The time that transpires between the image capture and the output of the decoded data, including locate time.

When enabled, the total read time is appended to the symbol data.

Serial Cmd: <K710,percent cell damage,total read time^a,capture time,locate time,decode time,pixels per element,ECC level,matrix size,quiet zone,symbol angle>

Default: Disabled

Options: 0 = Disabled 1 = Enabled

a. Total Read Time applies globally to all three Symbol Quality standards.

Capture Time

Definition: Capture time (in milliseconds) is a fixed “overhead” that includes the time of capture and transfer of the image.

When enabled, the capture time is appended to the symbol data.

Serial Cmd: <K710,percent cell damage,total read time,capture time,locate time,decode time,pixels per element,ECC level,matrix size,quiet zone,symbol angle>

Default: Disabled

Options: 0 = Disabled 1 = Enabled

Locate Time

Definition: The time in milliseconds from the start of image processing until the symbol has been located and is ready to be decoded.

When enabled, the locate time is appended to the symbol data.

Serial Cmd: <K710,percent cell damage,total read time,capture time,locate time,decode time,pixels per element,ECC level,matrix size,quiet zone,symbol angle>

Default: Disabled

Options: 0 = Disabled 1 = Enabled

Decode Time

Definition: The time in milliseconds required to decode a symbol.
When enabled, the decode time is appended to the symbol data.

Serial Cmd: <**K710**,percent cell damage,total read time,capture time,locate time,**decode time**,pixels per element,ECC level,matrix size,quiet zone,symbol angle>

Default: **Disabled**

Options: **0 = Disabled** 1 = Enabled

Pixels Per Element (Data Matrix Only)

Note: **Pixels Per Element** is not supported when **Q-Mode** is enabled.

Definition: The number of pixels for each element, either dark or light for both **x** and **y** directions.
When enabled, the pixels per element value is appended to the symbol data.

Serial Cmd: <**K710**,percent cell damage,total read time,capture time,locate time,decode time,**pixels per element**,ECC level,matrix size,quiet zone,symbol angle>

Default: **Disabled**

Options: **0 = Disabled** 1 = Enabled

Error Correction Level (Data Matrix Only)

Note: **Error Correction Level** is not supported when **Q-Mode** is enabled.

Definition: Outputs the Data Matrix ECC level.
When enabled, the ECC level is appended to the symbol data.

Serial Cmd: <**K710**,percent cell damage,total read time,capture time,locate time,decode time,pixels per element,**ECC level**,matrix size,quiet zone,symbol angle>

Default: **Disabled**

Options: **0 = Disabled** 1 = Enabled

Matrix Size (Data Matrix Only)

Note: **Matrix Size** is not supported when **Q-Mode** is enabled.

Definition: Defines the symbol matrix size, in number of pixels in both the **x** and **y** axis.
When enabled, the matrix size value is appended to the symbol data.

Serial Cmd: <**K710**,percent cell damage,total read time,capture time,locate time,decode time,pixels per element,ECC level,**matrix size**,quiet zone,symbol angle>

Default: **Disabled**

Options: **0 = Disabled** 1 = Enabled

Quiet Zone (Data Matrix Only)

Definition: When this feature is enabled, the size of the quiet zone is evaluated and a PASS or FAIL message is appended to the symbol data.

Serial Cmd: <K710,percent cell damage,total read time,capture time,locate time,decode time,pixels per element,ECC level,matrix size,**quiet zone**,symbol angle>

Default: Disabled

Options: 0 = Disabled 1 = Enabled

Symbol Angle (Data Matrix Only)

Definition: When this feature is enabled, the symbol orientation is appended to data output as a degree value representing the angle of the Data Matrix symbol's L-shaped finder pattern relative to the imager.

Serial Cmd: <K710,percent cell damage,total read time,capture time,locate time,decode time,pixels per element,ECC level,matrix size,quiet zone,**symbol angle**>

Default: Disabled

Options: 0 = Disabled 1 = Enabled

Microscan Symbol Quality Output by ESP

ESP's **Symbol Quality** interface allows you to evaluate Data Matrix symbols for compliance with a rigorous set of standards, such as Locate Time, Capture Time, and Decode Time.

First, determine which parameters you want to evaluate, using the **Symbol Quality** tree control.

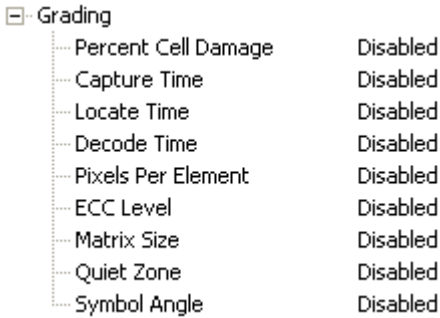

Once you have set these Data Matrix evaluation parameters, go to the **Preferences Tab** and set your Data Matrix Grading Report output preferences.



After your output preferences are set, click the **Data Matrix Grading** button.



There will be a wait of a few seconds, and then the evaluation results will appear in the **Symbol Quality** view, in a format similar to the one shown below.

Data Matrix Grading Report						GRADE
ISO/IEC 16022:	Symbol Contrast	= 80 %				A
	Print Growth	= 0.26	Dx - 51 %	Dnom - 50 %	Dmax - 65 %	A
			Dy - 54 %	Dmin - 35 %		
	Axial Nonuniformity	= 0.00	Xavg - 13.2			A
	Unused ECC	= 100 %	Yavg - 13.1			A
			Eact - 0			
			Emax - 10			
GRADING:	% Cell Damage	= 0 %				
	Total Read Time	= 99 ms				
	Capture Time	= 65 ms				
	Locate Time	= 27 ms				
	Decode Time	= 7 ms				
	Pixels/Element	= 13.1				
	ECC Level	= 200				
	Matrix Size	= 14x14				
	Quiet Zone	= PASS				

If you want to view the results in a report format, click the **Save Report** button. The report will be output in the format you chose in the **Preferences** dialog.



9 Matchcode

Contents

Matchcode by ESP	9-2
Matchcode Serial Commands	9-3
Overview of Matchcode	9-4
Matchcode Type	9-5
Match Replace.....	9-10
Mismatch Replace.....	9-11
New Master Pin	9-12

This section explains the Quadrus MINI 3's matchcode output functions and the master symbol database setup.

Matchcode by ESP

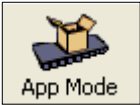

Click this button to bring up the **App Mode** view.



Click this button to bring up the **Matchcode** tree control.

Parameters	ESP Values
[-] Matchcode	
Matchcode Type	Disabled
Sequential Matching	Increment
Match Start Position	0
Match Length	1
Wild Card	*
Sequence on Noread	Enabled*
Sequence on Mismatch	Disabled
New Master Pin	Enabled*
[-] Match Replace	Disabled
Replacement String	MATCH
[+] Mismatch Replace	Disabled

To open nested options, **single-click** the +.

To change a setting, **double-click** the setting and use your cursor to scroll through the options.

Matchcode Serial Commands

Matchcode Type	< K223 ,matchcode type,sequential matching,match start position,match length,wild card character,sequence on No Read,sequence on mismatch>
Number of Master Symbols	< K224 ,number of master symbols>
New Master Pin	< K225 ,status>
Enter Master Symbol Data	< K231 ,master symbol number,master symbol data>
Request Master Symbol Data	< K231? ,>[for all] or < K231? ,master symbol number>
Delete Master Symbol Data	< K231 ,master symbol number,>
Match Replace	< K735 ,status,match replacement string>
Mismatch Replace	< K736 ,status,mismatch replacement string>

Overview of Matchcode

- Definition:* **Matchcode** allows the user to store master symbol data in the imager's memory, compare that data against other symbol data, and define how symbol data and/or discrete signal output will be directed. A master symbol database can be set up for up to 10 master symbols. **Note: Matchcode** will function with multiple symbols; however, if **Matchcode Type** is set to **Sequential** or if **Triggering Mode** is set to **Continuous Read 1 Output**, the imager will behave as if **Number of Symbols** were set to **1**, regardless of the user-defined configuration.
- Usage:* Matchcode is used in applications to sort, route, or verify data based on matching the specific symbol in a variety of ways as defined in this section. For example, a manufacturer might sort a product based on dates that are embedded in the symbol.

Steps for Entering and Using Master Symbols

1. Set **Triggering Mode** to **External** or **Serial**.
2. Choose the method of symbol comparison that fits your application.
3. Define the output you want to achieve with your matchcode setup:
 - a. Symbol data output
 - b. Discrete output
4. Select the number of master symbols you want to create.
5. Decide which of 4 ways you want to enter your master symbol(s):
 - a. Use **ESP** to type master symbol data directly.
 - b. Send a serial command with symbol data in the form of **<M231, master symbol#, data>**.
 - c. Send a **<G>** (Read Next Symbol as Master Symbol) command.
 - d. Enable the **New Master Pin** command and activate the discrete input to store the next symbol read as the master symbol.

Matchcode Type

Definition: Allows the user to choose the way that master symbols will be compared with subsequently read symbols.

Note: First set **Triggering Mode** to **External** or **Serial**.

ESP:

Parameters	
[-] Matchcode	
Matchcode Type	Disabled*
Sequential Matching	Disabled*
Match Start Position	Enabled
Match Length	Wild Card
Wild Card	Sequential
Sequence on Noread	Enabled
Sequence on Mismatch	Disabled
New Master Pin	Disabled
[-] Match Replace	Disabled
Replacement String	MATCH
[-] Mismatch Replace	Disabled
Replacement String	MISMATCH

Serial Cmd: *<K223,matchcode type,sequential matching,match start position,match length,wild card character,sequence on No Read,sequence on mismatch>*

Default: **Disabled**

Options: **0 = Disabled**
 1 = Enabled
 2 = Wild Card
 3 = Sequential

Disabled: Has no effect on operations.

Enabled: Instructs the imager to compare symbols or portions of symbols with the master symbol.

Wild Card: Allows the user to enter user-defined wild card characters in the master symbol.

Sequential: Instructs the imager to sequence after each match (numeric only) and compare symbols or portions of symbols for sequential numbers.
Note: If **Matchcode Type** is set to **Sequential**, the imager will behave as if **Number of Symbols** were set to **1**, regardless of the user-defined configuration.

Sequential Matching

Usage: Useful in tracking product serial numbers that increment or decrement sequentially.

Definition: With Sequential enabled, Sequential Matching determines if a count is in ascending (incremental) or descending (decremental) order.

Serial Cmd: <**K223**,matchcode type,**sequential matching**,match start position,match length,wild card character,sequence on No Read,sequence on mismatch>

Default: **Increment**

Options: **0 = Increment** 1 = Decrement

Match Start Position

Usage: **Match Start Position** is useful in defining specific portions of a symbol for comparison. For example, if a symbol contains a part number, manufacturing date, and lot code info, but you are only interested in the part number information, you can set the imager to sort only the part number and ignore the other characters.

Definition: **Match Start Position** determines the portions of symbols that will be matched by defining the first character in the symbol (from left to right) that will be compared with those of the master symbol, when **Matchcode Type** is set to **Enabled** or **Sequential**.

Function: For example, if **Match Start Position** is set to **3**, the first 2 characters read in the symbol will be ignored and only the 3rd and subsequent characters to the right will be compared, up to the number of characters specified by **Match Length**.

Serial Cmd: <**K223**,matchcode type,sequential matching,**match start position**,match length,wild card character,sequence on No Read,sequence on mismatch>

Default: **0**

Options: 0 to 3000

Note: **Match Start Position** must be set to **1** or greater to enable this feature. A **0** setting will disable this feature.

Match Length

Usage: *Example:* If **Match Length** is set to **6** in a 10-character symbol, and **Match Start Position** is set to **2**, only the 2nd through 7th characters (from left to right) will be compared.

Definition: Defines the length of the character string that will be compared with that of the master symbol when **Match Start Position** is set to **1** or greater. When **Match Start Position** is set to **0**, no comparison will occur.

Serial Cmd: <**K223**,matchcode type,sequential matching,match start position,**match length**,wild card character,sequence on No Read,sequence on mismatch>

Default: **1**

Options: 1 to 3000

Wild Card Character

- Usage:** *Example:* With **Wild Card Character** defined as the default asterisk, defining **CR*34** as the master symbol will result in matches for CR134 and CR234, but not CR2345. Entering the wild card at the end of the master symbol, as in **CR***, will result in matches for variable symbol lengths such as CR1, CR23, CR358, etc.
- Definition:** Wild Card Character allows a user to define a wild card character as part of the master symbol.
- Serial Cmd:** *<K223,matchcode type,sequential matching,match start position,match length,wild card character,sequence on No Read,sequence on mismatch>*
- Default:** * (asterisk)
- Options:** Any ASCII character.

Important: The ASCII characters <, >, and , can only be entered as hex pairs:

For <: *<K223h,,,,,3C>*

For >: *<K223h,,,,,3E>*

For , : *<K223h,,,,,2C>*

See [ASCII Character Entry Modifier](#) on page 3-32 for a detailed explanation of how to enter ASCII characters as hex values.

Sequence on No Read

Usage: **Sequence on No Read** is useful when the imager needs to stay in sequence even if no decode occurs.

Definition: When **Sequence on No Read** is **Enabled** and **Matchcode** is set to **Sequential**, the imager sequences the master symbol on every match or No Read. When disabled, it does not sequence on a No Read.

Serial Cmd: <**K223**,matchcode type,sequential matching,match start position,match length,wild card character,**sequence on No Read**,sequence on mismatch>

Default: **Enabled**

Options: 0 = Disabled **1 = Enabled**

As an example of **Sequence on No Read Enabled**, consider the following decodes:

<i>Master Symbol</i>	<i>Decoded Symbol</i>	<i>Master Symbol after Decode</i>
001	001	002
002	002	003
003	No Read	004 (sequence on No Read)
004	004	005
005	No Read	006 (sequence on No Read)
006	No Read	007 (sequence on No Read)
007	007	008

As an exmld of **Sequence on No Read Disabled**, consider the following series of decodes:

<i>Master Symbol</i>	<i>Decoded Symbol</i>	<i>Master Symbol after Decode</i>
001	001	002
002	002	003
003	No Read	003 (not sequenced)
003	003	004
004	No Read	004 (not sequenced)
004	No Read	004 (not sequenced)
004	004	005

Mismatch Replace

- Usage:** Provides a convenient shortcut for applications that need to output a predefined text string whenever a symbol does not match a master symbol.
- Definition:** Outputs a user-defined data string whenever a mismatch occurs and **Matchcode** is enabled.
- Serial Cmd:** **<K736,status,replacement string>**
- Default:** **Disabled**
- Options:** **0 = Disabled** 1 = Enabled

Replacement String

- Definition:** User-defined data string that, when enabled, replaces symbol data whenever a mismatch occurs.
- Serial Cmd:** **<K736,status,replacement string>**
- Default:** **MISMATCH**
- Options:** An ASCII string up to 64 characters.

Important: The ASCII characters **<**, **>**, and **,** can only be entered as hex pairs:

For **<**: **<K736h,,3C>**

For **>**: **<K736h,,3E>**

For **,**: **<K736h,,2C>**

See [ASCII Character Entry Modifier](#) on page 3-32 for a detailed explanation of how to enter ASCII characters as hex values.

New Master Pin

Definition: If **Matchcode** and **New Master Pin** are enabled and the new master pin is momentarily connected to ground (must be held low for a minimum of 10 ms) master symbol information will be loaded into the database based on the next read cycle that achieves a Good Read, starting with **Index 1**. The **Master Symbol Database** will be loaded with all symbols decoded in the read cycle as long as it does not exceed the **Number of Master Symbols** parameter.

Serial Cmd: **<K225,status>**

Default: **Disabled**

Options: **0 = Disabled** 1 = Enabled

New Master Load Status

Definition: The new master status responds with the number of the next master position to be loaded, where 0 represents “idle” or “no master to be loaded.”

Example: If the user has the **Number of Master Symbols** set to 1, and then either sends a **<G>** or toggles an active **New Master Pin**, the state will be 1, and prior to reading and effectively loading position 1, the response to **<NEWM>** would be **<NEWM/1>**. Once a symbol has been read and loaded, the status will be cleared: **<NEWM/0>**.

Serial Cmd: **<NEWM>**

■ 10 Camera and IP Setup

Contents

Camera and IP Setup by ESP	10-2
Camera and IP Setup Serial Commands.....	10-3
Video.....	10-4
Evaluation	10-5
Calibration.....	10-9
Window of Interest.....	10-10
Configuration Database.....	10-13
Dynamic Setup	10-14
Pixel Sub-Sampling	10-15
Camera Settings.....	10-16
Focal Distance.....	10-17
Focal Distance Table (Read-Only)	10-18
Increment Focus Position	10-19
Decrement Focus Position.....	10-19
IP Threshold	10-20
Number of Symbols in Field of View.....	10-22
Damaged Symbol	10-23
IP Mode	10-24
Hollow Mode.....	10-26
Mirrored Image	10-27
Illumination Brightness.....	10-28
Color Processing	10-29
Skew Correction	10-30

This section provides adjustment parameters for the physical controls of the camera, image acquisition, database settings, and image diagnostics.

Camera and IP Setup by ESP



Click this button to bring up the **App Mode** view.



Click this button to bring up the **Camera Setup** tree control.

Parameters	ESP Values
[-] Camera Setup	
Color Filter	General Purpose
[-] Camera	
Gain	20
Shutter Speed	80
Illumination Brightness	High
Focus Distance	300
Sub-sampling	Disabled
[-] Window of Interest	
Top	0
Left	0
Height	1536
Width	2048
[-] Image Processing Settings	
Processing Mode	Standard
FLM Direction	Auto
Image Processing Timeout	5000
Background Color	White*
Mirrored Image	White*
Damaged Symbol Status	Black
[-] Skew Correction	
Line Speed	0
Symbol Direction	Right
[-] Thresholding	
Threshold Mode	Adaptive
Threshold Value	128
Cycle Minimum	0
Cycle Maximum	255
Cycle Step	10
Adaptive Contrast	100
[+] Capture Mode	Continuous Capture

To change a setting, **double-click** the setting and use your cursor to scroll through the options.

To open nested options, **single-click** the +.

Camera and IP Setup Serial Commands

IP Threshold	<K512,threshold mode,fixed threshold value,cycle min,cycle max,cycle step,adaptive contrast percent>
Mirrored Image	<K514,mirrored image>
Window of Interest	<K516,row pointer,column pointer,row depth,column width>
Hollow Mode	<K517,hollow mode status>
Number of Symbols in Field of View	<K518,number of symbols in field of view>
Damaged Symbol	<K519,damaged symbol status>
Focal Distance	<K525,focal distance>
Increment Focus Position	<K525+>
Decrement Focus Position	<K525->
Focal Distance Table (Read-Only)	<K526,number of focal distances,focal distance>
IP Mode	<K527,IP Mode,FLM direction>
Illumination Brightness	<K536,brightness>
Skew Correction	<K537,line speed,symbol direction>
Camera	<K541,shutter speed,gain>
Pixel Sub-Sampling	<K542,sub-sampling>
Color Processing	<K543,color filter>

Video

The **Video** view is similar to the **EZ Mode** interface, in that the user has the ability to perform the same **Locate**, **Calibrate**, and **Test** routines. There is also a focal distance adjustment tool to the right of the video view.

Video also features **Capture and Decode** functionality, which is similar to the **Configuration** interfaces (**Communication**, **Read Cycle**, **Symbologies**, **I/O**, **Matchcode**, and **Diagnostics**).

The screenshot shows the Video interface with the following components and callouts:

- Locate**: Activates the imager's target pattern and initiates live video display of the symbol in the field of view.
- Calibrate**: Initiates Calibration routine.
- Capture and Decode**: Allows the user to take an image capture of the symbol in the field of view at any time, and to decode the symbol data. Similar to the **Capture and Decode** function in the **Configuration** views.
- Test**: Initiates the **Test** routine. Allows the user to test the imager's read rate and decodes per second, and also displays decoded symbol data in the field at the bottom of the screen. Click **Stop** to end the **Test** routine.
- Stop**: Click **Stop** to end the **Test** routine.
- Decodes per Second** (checked): When enabled, shows the symbol in higher contrast than the default contrast value.
- Contrast** (unchecked): When enabled, shows the symbol in higher contrast than the default contrast value.
- Focal Distance Control** (4.00 inches): Clicking this icon enables the focal distance slide control to the right of the video view. The focal distance value is displayed just below the icon.
- Symbol Data Table**:

Attribute	Value
Number of Symbols	1
Symbol #1	
Symbol Data	Microscan

Evaluation

In **Evaluation**, you can view images currently in the imager, capture and decode a symbol, save it as a digital file, and perform histogram and line scan evaluations.

When you click on the **Evaluation** tab, you will see the images that are currently stored in the imager.

Click **Receive** to refresh this view.

Click **Capture/Decode** to display the current stored image. Only one capture and decode event will occur, regardless of read cycle settings.

Click **Read** to trigger a read cycle. If there is enough time in the read cycle, up to 32 good reads (or 6 full-scale images) can be captured and displayed, depending on the size of the images, and depending on the number enabled in **Number of Captures** under **Capture Mode** in the **Camera Setup** menu tree to the left of the tabs.

If you click **Save**, the current image will be saved to the location of your choice.

Note: An image can only be saved in the format in which it was uploaded to **ESP**. JPEG images will be saved as **.jpg**, and bitmaps will be saved as **.bmp**.

When you click the **JPEG Image** box, notice that the **Line Scan** button is grayed out.

The JPEG option allows faster captures and transfers, but since the JPEG standard compresses image data, it is not suitable for the more rigorous demands of line scan evaluation.

JPEG also allows you to adjust the image quality (resolution) by adjusting the sliding tab between 1 and 100, 1 being the lowest quality and 100 being the highest.

When possible, use the highest quality; when image transfer speed must be increased, use a lower image quality setting. Adjustments for this setting will depend on your specific hardware and software limitations.

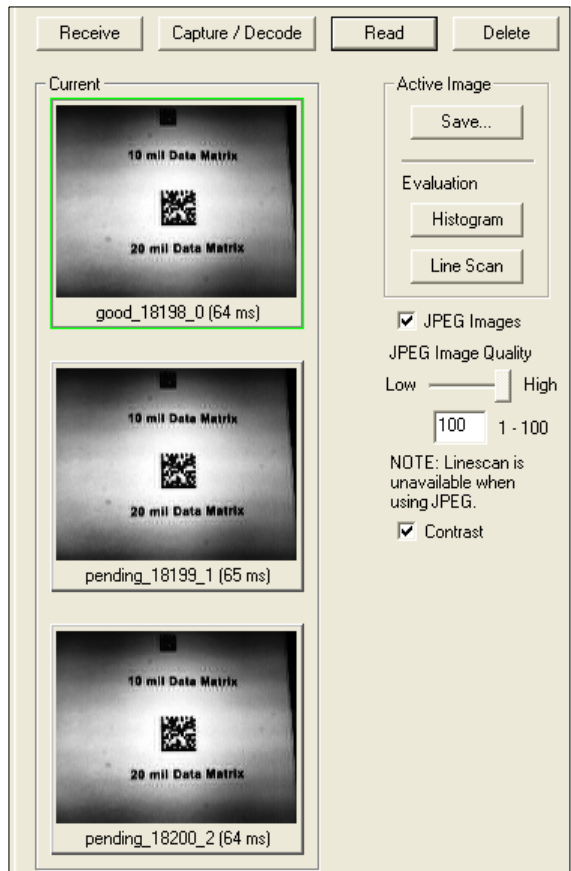

Histogram

Usage: Useful in determining quality and contrast of symbols.

Definition: A histogram is a graphic representation of the numeric count of the occurrence of each intensity (gray level) in an image. The horizontal axis represents the values of gray levels, and the vertical axis represents the number of pixels for each gray level.

Note: Since histograms are performed in the imager, the results will be saved regardless of whether the image was uploaded as a JPEG (.jpg) or a bitmap (.bmp).

1. From the **Evaluation** window, click the **Histogram** button.
The current image is transferred into the histogram operation. This may take a moment, since all the relevant pixels are being evaluated intensively.
2. When the **Histogram** window opens, you may need to expand the window and/or adjust the scroll bars in order to bring the image into view.
3. To generate a histogram, click and drag your cursor diagonally across the symbol or a portion of the symbol.

The image will be surrounded by an “area of interest box”, a dashed blue line with red anchor points that can be selected and moved by placing a cursor inside the box, and can be resized by clicking and dragging the anchor points.

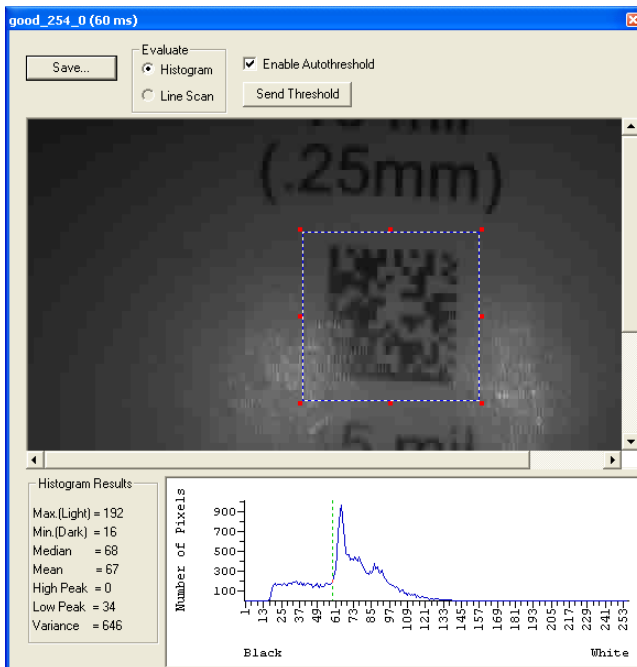

Threshold (Histogram)

Enable Autothreshold is checked by default.

To adjust the threshold manually,

1. Uncheck the **Enable Autothreshold** box.
2. Move the threshold marker (vertical green dashed line) in the **Histogram** chart.

Hint: This should be midway between the maximum and minimum curves.

3. Click on the **Send Threshold** button to adopt the new threshold position.

Line Scan

1. From the **Evaluation** tab, click the **Line Scan** button. A window like that shown below will appear.
 2. Drag your cursor *horizontally* across the image.
- This will create a dashed horizontal line. Pixel information and a visual representation of the dark and light pixels will be displayed below the image.

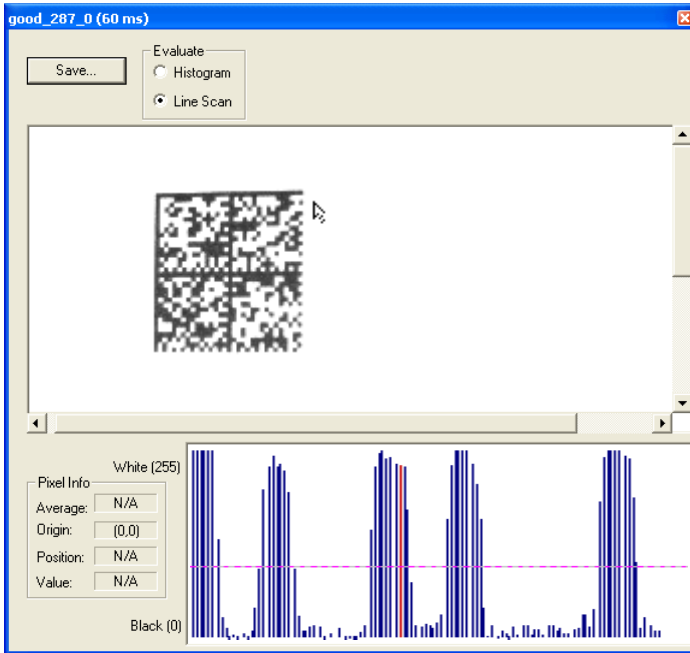

When you center your cursor over the dashed line, it becomes a double arrow cross. This allows you to move the line anywhere in the window. You can also use your keyboard arrows to move the line incrementally in any direction.

As with the histogram, the line scan compares light and dark pixels, but in a spatial distribution. On the **Y** axis of the graph below, **0** is black and **255** is white; the **X** axis represents the horizontal axis of the symbol as described by the line scan.

When you click anywhere on the graph, a vertical red line appears at that point and its position and value (in terms of black-to-white) are updated in the **Pixel Info** table to the left of the graph (237 in this example). In addition, a horizontal dashed red line is displayed that indicates the average value.

Calibration

The Calibration interface in **ESP** is a powerful and intuitive way to optimize the imager's performance. It allows the user to control several complex, simultaneous calibration operations, and to follow the progress of those operations using cues such as progress bars, real-time representations of calibration values, and other dynamic user feedback.

See Chapter 4, [Calibration](#), for full documentation of this feature.

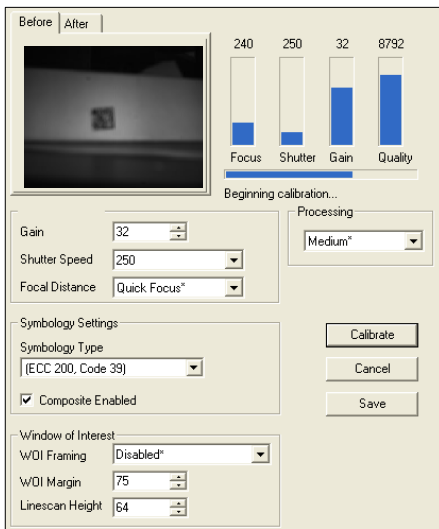

ESP's Calibration interface shown during a calibration routine

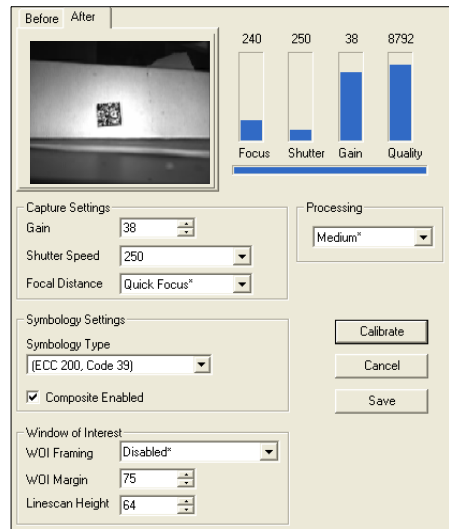

ESP's Calibration interface shown after a calibration routine

Window of Interest

The active pixel area of the image sensor is called the **Window of Interest (WOI)**. The WOI allows the user to select an area of the field of view in which the desired symbol is located.

The programmable window of interest increases decode speed, improves threshold, and makes it easy to select specific symbols from among several in the field of view. The user provides the upper-left pixel location and the size of the window to define the Window of Interest.

[-] Window of Interest	
Top	0
Left	0
Height	1536
Width	2048

Caution: Window of Interest will shrink the field of view and therefore could cause symbols to be missed in dynamic applications.

Window of Interest by ESP

1. From the **Camera** menu, click the **WOI** tab to bring up **Window of Interest**.

If you haven't already captured an image, click the **Capture and Decode** button to decode the present image. If successful, the **Good Read** indicator on the **WOI** tab will be green and the symbol will appear in the pane below.

Note: You can resize the image by clicking and dragging the **ESP** window from the lower right corner. This is useful where very small symbols are being read.

2. Click and drag your cursor over the symbol that you want to isolate for reading.
Notice that the surrounding area goes black.

You can use the handles on the image area that you have just drawn to resize the region of interest. You can also click on the center of the window of interest and move it.

3. Test the new settings in **Read Rate Mode**.

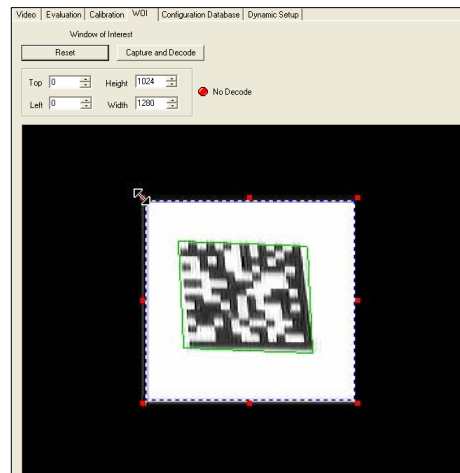
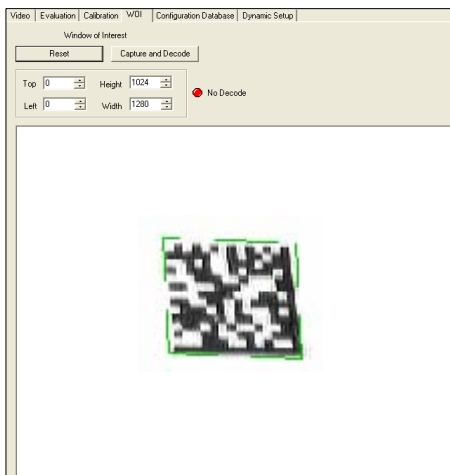

Note: To remove the window of interest, click the **Reset** button or click anywhere in the WOI pane.

Note that all pixels not in the WOI are defined as black.

Because the imager has far less processing to do in a smaller window, read rates typically increase dramatically. One possible downside is that the chance of missing a symbol increases with the smaller window. Always verify that your WOI will be large enough to allow for any random movement of symbols in your field of view.

Window of Interest by Serial Command

The figure below shows where to locate the start position of the row and column pointers and how to measure the column depth and row width dimensions.

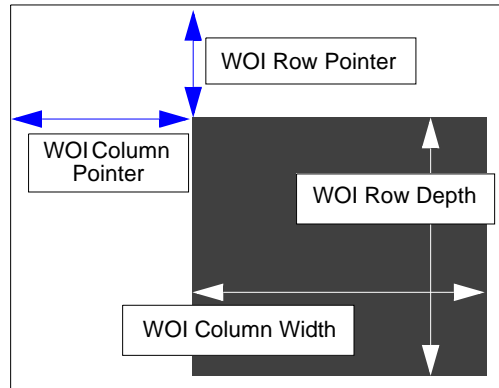

Top (Row Pointer)

Definition: Defines the row position of the upper-left starting point of the window.

Serial Cmd: <K516,row pointer,column pointer,row depth,column width>

Default: 0

Options: 0 to (1536 - row depth)

Left (Column Pointer)

Definition: Defines the column position of the upper-left starting point of the window.

Serial Cmd: <K516,row pointer,column pointer,row depth,column width>

Default: 0

Options: 0 to (2048 - column width)

Important: The column pointer setting must be an even value. If a user enters an odd value, it will be decreased automatically to the nearest even value. For example, if a user enters a setting of **101**, it will automatically be reduced to **100** (although a user request for this setting would still show **101**).

Height (Row Depth)

Definition: Defines the size, in rows, of the window. Maximum value is defined as the maximum row size of the image sensor minus the **Top** value.

Serial Cmd: <K516,row pointer,column pointer,row depth,column width>

Default: 1536

Options: 3 to (1536 - row pointer)

Width (Column Width)

Definition: Defines the column position of the upper-left starting point of the window.

Serial Cmd: <K516,row pointer,column pointer,row depth,column width>

Default: 2048

Options: 8 to (2048 - column pointer)

Important: The column width value must be a modulus 8 value. If a user enters a non-Modulus 8 value, it will be decreased automatically to the nearest modulus 8 value. For example, if a user enters a setting of **639**, it will automatically be reduced to **632** (although a user request for this setting would still show **639**).

Configuration Database

The Configuration Database allows the user to manage multiple configuration profiles. It is a useful tool in applications that require several different imager configurations to be applied sequentially, and it allows the user to perform far more complex operations than would be possible with only one set of configuration parameters.

See Chapter 11, [Configuration Database](#), for full documentation of this feature.

Video | Evaluation | Calibration | WDI | Configuration Database | Dynamic Setup

Active Indexes: 5 | Auto Sync Database settings with Reader | Advanced Options...

Capture Settings: Capture Index, Shutter Speed, Gain, Focal Distance, Sub-sampling, Top, Left, Height, Width

Processing Settings: Threshold Mode, Fixed Threshold Value, Processing Mode, Narrow Margins, Background, Symbol Type

Index	Capture Index	Shutter Speed	Gain	Focal Distance	Sub-sampling	Top	Left	Height	Width	Threshold Mode	Fixed Threshold Value	Processing Mode	Narrow Margins	Background	Symbol Type	
1	80	20	3.00	Disabl	0	0	1536	2048	...	Adapti	128	Stand	Disabl	White	Disabled	Test
2	80	20	3.00	Disabl	0	0	1536	2048	...	Adapti	128	Stand	Disabl	White	Disabled	Test
3	80	20	3.00	Disabl	0	0	1536	2048	...	Adapti	128	Stand	Disabl	White	Disabled	Test
4	80	20	3.00	Disabl	0	0	1536	2048	...	Adapti	128	Stand	Disabl	White	Disabled	Test
5	80	20	3.00	Disabl	0	0	1536	2048	...	Adapti	128	Stand	Disabl	White	Disabled	Test
6	80	20	3.00	Disabl	0	0	1536	2048	...	Adapti	128	Stand	Disabl	White	Disabled	Test
7	80	20	3.00	Disabl	0	0	1536	2048	...	Adapti	128	Stand	Disabl	White	Disabled	Test
8	80	20	3.00	Disabl	0	0	1536	2048	...	Adapti	128	Stand	Disabl	White	Disabled	Test
9	80	20	3.00	Disabl	0	0	1536	2048	...	Adapti	128	Stand	Disabl	White	Disabled	Test
10	80	20	3.00	Disabl	0	0	1536	2048	...	Adapti	128	Stand	Disabl	White	Disabled	Test

Capture for Every Index | Show Database Index in Output | Sort Index Positions on Good Reads

Calibrate... | Receive Settings | Send Settings | Load Current To Index | Load Index To Current

Configuration Database view, set for 5 Active Indexes, with Capture Settings highlighted

Dynamic Setup

Dynamic Setup is used to calculate image capture timing during a read cycle. Without proper timing, the imager will not be able to decode all symbols in a read cycle. An external trigger is used to activate image captures so the user can make timing adjustments as capture events occur.

The screenshot shows the 'Dynamic Setup' window with a central video feed of a barcode. To the right is a vertical 'Read Rate' indicator, currently at 100%. Below the video are three spin boxes for 'Capture #' (1), 'Number of Captures' (6), and 'Number of Symbols' (1). Below these are 'Delay (Sec)' (0.066464) and 'Delay Adjustment' options: 'Coarse' (selected) and 'Fine'. A horizontal slider is positioned below the delay field, with 'Decrease' and 'Increase' labels. Callout boxes provide detailed explanations for the Read Rate indicator and the Delay Adjustment slider.

The user can control **Capture #**, **Number of Captures**, and **Number of Symbols** using these spin boxes.

Read Rate is represented graphically in real-time as the user makes adjustments to the time delay between image captures.

The **Delay Adjustment** slider allows the user extremely precise control of the time delays between image captures in a read cycle. Delay values are shown in seconds in the field above the slider. The **Coarse** and **Fine Delay Adjustment** options determine whether larger or smaller adjustment increments will be used.

Pixel Sub-Sampling

Definition: The camera can be enabled to sub-sample pixels in the specified image frame. Sub-sampling can be set to either 4:1 or 16:1. These ratios signify the sampling rate.

Usage: `<K542,sub-sampling>`

Default: **Disabled**

Options: **0 = Disabled** 1 = 4:1

2 = 16:1

4:1

At this sampling rate, 1 pixel is output for every 4 pixels sampled. The image will be sampled 2:1 vertically and 2:1 horizontally, for a combined 4:1 ratio. An image with dimensions of 640 x 480 will be scaled to 320 x 240.

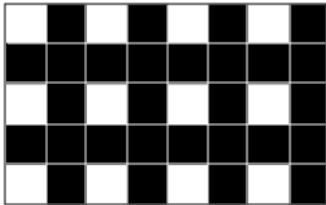

16:1

At this sampling rate, 1 pixel is output for every 16 pixels sampled. The image will be sampled 4:1 vertically and 4:1 horizontally, for a combined 16:1 ratio. An image with dimensions of 640 x 480 will be scaled to 160 x 120.

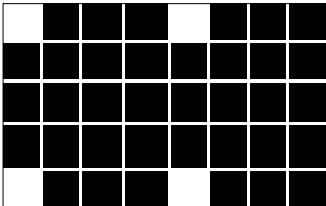

Camera Settings

Camera parameters are typically obtained during the calibration process, and do not necessarily need to be modified directly by the user.

Optics

The Quadrus MINI 3 Imager has two different optical configurations available: **Standard Density** and **Micro Density**. Determine the optics of your imager and find the corresponding camera values in the following sections.

Standard Density and Micro Density Optics

Shutter Speed

Usage: Faster shutter speeds reduce blurring in faster applications. Slower shutter speeds are useful in slower applications and lower contrast applications.

Definition: Sets the exposure or integration time for the image sensor pixels. The shutter speed setting in relation to the speed of the object is critical. If a slow shutter speed is selected to capture fast-moving objects, blurring or smearing of the image will occur. As shutter speed is increased, more light and gain become necessary, because the pixels' exposure time has decreased.

Serial Cmd: <K541,shutter speed,gain>

Default: 60 (Standard Density) 80 (Micro Density)

Options: 15 to 15,000

Gain

Usage: Can be used to adjust the brightness of the image.

Definition: Sets the gain value for the image sensor. This setting can be configured through calibration, which is the recommended method. A higher gain value will increase the brightness of the image, but the image will be "noisier".

Important: Shutter Speed should be adjusted before **Gain**.

Each of the image sensor's colors has a separate gain setting, and the white balance adjustment provides gain offsets for color channels **R** (red), **G** (green), and **B** (blue) to provide consistent white across the image. Adjustments to both the R and B channels are usually required. The gain value that is set here is the base gain value for all colors. If a color requires additional gain to provide white balance, the offset is added to this gain value. However, when in the analog gain range, the gain + offset cannot exceed 42, and when in the digital gain range, the gain + offset cannot exceed 48. For optimal white balance, avoid setting gain near these values.

Note: Microscan recommends using only the analog gain range (0 to 42). Image quality is degraded within the digital gain range (43 to 48).

Serial Cmd: <K541,shutter speed,gain>

Default: 20

Options: Analog gain: 0 to 42 Digital gain: 43 to 48

Focal Distance

Definition: This setting provides a means for configuring the focal distance of the imager. The input value is in terms of inches and is divided by 100 internally. For example, 400 sets the imager to a focal distance of 4 inches. It is important to note that the imager may not have an exact match for the focal position requested. The imager has a range of steps that are calibrated and mapped to focal positions. This input value is matched to the closest focal position step that the system supports. It is also important to keep in mind that the resolution of the system is not linear. As the imager's focal distance setting increases, the resolution decreases. This effect is offset somewhat by the fact that the depth of field increases at greater focal distances.

Serial Cmd: **<K525,focal distance>**
Default: **Standard Density = 400 (4")**
Options: 200 (2") to 600 (6")
Default: **Micro Density = 300 (3")**
Options: 200 (2") to 500 (5")

Note: In the factory, the imager calibrates its focus curve and matches the focus motor steps to various focal positions. Therefore, each imager has a slightly different focus map of stepper motor positions vs. focal positions. This allows the user to enter a focal distance that causes the imager to select the closest stepper motor position required to obtain the user-defined setting. In this way, there is consistency between imagers for any given focal distance input.

Note: To view a list of focal distances supported by your imager, use the **<K526>** command.

Focal Distance Table (Read-Only)

Number of Focal Distances

Definition: Specifies the number of focal distances supported by the imager.

Serial Cmd: <**K526**,*number of focal distances*,*focal distance*>

Options: 1 to 255

Focal Distance

Definition: Each (x) output represents a focal distance that is supported by the imager. The values are specified in 1/100ths of an inch, but the focal distance increments and decrements are not that fine. The focal distance is defined from a curve equation whose constants are calibrated during factory setup. The output value is in terms of inches, and it is multiplied by 100 to remove the decimal place. For example, an output of 375 would signify a focal distance of 3.75".

Serial Cmd: <**K526**,*number of focal distances*,*focal distance*>

Options: 200 (2") to 600 (6") (Standard Density)

200 (2") to 500 (5") (Micro Density)

Increment Focus Position

Definition: Increments the imager's focus setting to the next focal distance supported by the imager.

Note: Use the **Focus Distance Table** command **<K526>** to find the focal distance settings supported by your imager.

Serial Cmd: **<K525+>**

Options: 200 (2") to 600 (6") (Standard Density)
200 (2") to 500 (5") (Micro Density)

The following example assumes a focus position setting of 400 (4"), with access to the focus distance values shown in the imager response.

Send: **<K526?>**

Response: <K526,30,202,212,225,241,264,410,447,466,481,492,502,511,519,526,533,539,545,550,556,561,565,570,574,578,582,586,590,594,597,601>

The current focus position would be 410 (4.1").

Send: **<K525+>**

Send: **<K525?>**

Response: <K525,447>

Decrement Focus Position

Definition: Decrements the imager's focus setting to the next focal distance supported by the imager.

Note: Use the **Focus Distance Table** command **<K526>** to find the focal distance settings supported by your imager.

Serial Cmd: **<K525->**

Options: 200 (2") to 600 (6") (Standard Density)
200 (2") to 500 (5") (Micro Density)

The following example assumes a focus position setting of 400 (4"), with access to the focus distance values shown in the imager response.

Send: **<K526?>**

Response: <K526,30,202,212,225,241,264,410,447,466,481,492,502,511,519,526,533,539,545,550,556,561,565,570,574,578,582,586,590,594,597,601>

The current focus position would be 410 (4.1").

Send: **<K525->**

Send: **<K525?>**

Response: <K525,264>

IP Threshold

Note: IP Threshold is not supported when **Q-Mode** is enabled.

Threshold Mode

Usage: **Fixed Mode** works best when decode time must be as short as possible and the reflectance and illumination of the symbol area is uniform and unchanging. **Cycle Fixed Mode** is useful in applications where decode time can be slightly longer, and reflectance and illumination of the symbol area is uniform and unchanging. Otherwise, **Adaptive Mode** is the preferred mode.

Definition: This value switches the image processing threshold mode between the **Adaptive**, **Fixed**, and **Cycle Fixed** modes. An adaptive routine sets the light/dark threshold using data acquired from the current read. A fixed routine applies the same gray scale threshold value to each and every symbol. A cycle fixed routine loops through a pre-defined range of values (**Cycle Min** to **Cycle Max**) by pre-defined increments (**Cycle Step**).

Serial Cmd: `<K512,threshold mode,fixed threshold value,cycle min,cycle max,cycle step,adaptive contrast percent>`

Default: **Adaptive**

Options: **0 = Adaptive** 1 = Fixed 2 = Cycle Fixed

Fixed Threshold Value

Usage: A higher value will increase the threshold for distinguishing between light and dark elements.

Definition: Determines how the imager will distinguish light pixels from dark pixels. This value is used for **Fixed Mode** only. When **Adaptive Mode** is set, this value is ignored.

Serial Cmd: `<K512,threshold mode,fixed threshold value,cycle min,cycle max,cycle step,adaptive contrast percent>`

Default: **128**

Options: 0 to 255

Cycle Min

Definition: Starting value of the cycle mode.

Serial Cmd: `<K512,threshold mode,fixed threshold value,cycle min,cycle max,cycle step,adaptive contrast percent>`

Default: **0**

Options: 0 to 255

Important: Cycle Min must be a smaller numerical value than Cycle Max.

Cycle Max

Definition: Ending value of the cycle mode.

Serial Cmd: <**K512**,threshold mode,fixed threshold value,cycle min,**cycle max**,cycle step,adaptive contrast percent>

Default: **255**

Options: 0 to 255

Important: Cycle Max must be a greater numerical value than Cycle Min.

Cycle Step

Definition: The numerical value of a single cycle mode increment.

Serial Cmd: <**K512**,threshold mode,fixed threshold value,cycle min,cycle max,**cycle step**,adaptive contrast percent>

Default: **10**

Options: 0 to 255

Adaptive Contrast Percent

Definition: The percentage value that sets the adaptive threshold map. Useful for underprinted or overprinted symbols.

For example, if a value of 110 is entered, the adaptive threshold will be 110% of the original values.

Serial Cmd: <**K512**,threshold mode,fixed threshold value,cycle min,cycle max,cycle step,**adaptive contrast percent**>

Default: **100**

Options: 1 to 200

Number of Symbols in Field of View

Definition: This command allows the user to determine how **FLM** will behave in relation to the candidate symbols in the field of view.

Serial Cmd: **<K518,number of symbols in field of view>**

Default: **Any number of symbols**

Options: **0 = Any number of symbols**

1 = One symbol

2 = More than one symbol

Note: When the number of symbols in the field of view is set to **1**, codeword stitching from all scaled image processes is allowed for PDF417 and MicroPDF417.

Note: This variable is used in **Fast Linear Mode**. **FLM** usually considers the whole image as one candidate, but when **Number of Symbols in Field of View** is set to **2**, **FLM** will try to locate the candidates first and then decode. The symbols cannot be side-by-side—they must be parallel.

Note: **Number of Symbols in Field of View** is not supported when **Q-Mode** is enabled.

IP Mode

Definition: Determines the decode algorithm that will be used to process images.
Important: Options **2** and **3** are not available in non-Q-Mode imagers.

Usage: <**K527,IP Mode,FLM direction**>

Default: **Both Standard Mode and Q-Mode**

Options: 0 = Standard Mode 1 = Fast Linear Mode 2 = Q-Mode **3 = Both**

Standard Mode

In **Standard Mode**, the imager processes the image using the standard decode algorithm.

Fast Linear Mode

In **Fast Linear Mode**, the imager quickly locates and decodes linear symbols that are oriented in the field of view in such a way that a horizontal or vertical scan line can pass completely through the symbol. The entire image is assumed to be a candidate, and is read horizontally, vertically, or in both directions. When the number of symbols in the field of view <**K518**> is set to 2, **Fast Linear Mode** will try to locate the candidates first and then decode. The candidate symbols cannot be side-by-side—they must be parallel.

Q-Mode

In **Q-Mode**, the image is processed using a special algorithm that is designed to provide quick, consistent decode times. Standard Mode may be required for more challenging symbols.

Note: The following items are not supported when **Q-Mode** is enabled:

- **Hollow Mode**
- **Number of Symbols in Field of View**
- **Damaged Symbol**
- **IP Threshold**
- **BC412** Symbology
- **2D Enhanced** (Narrow Margins)
- **Large Intercharacter Gap (Code 39)**
- **Large Intercharacter Gap (Codabar)**
- **Guard Bar Status (Interleaved 2 of 5)**
- **Codeword Collection (PDF417)**
- **Print Growth** (ISO/IEC 16022 Symbol Quality Output)
- **Axial Non-Uniformity (Data Matrix Only)** (ISO/IEC 16022 Symbol Quality Output)
- **Unused Error Correction (Data Matrix Only)** (ISO/IEC 16022 Symbol Quality Output)
- **Percent Cell Damage (Data Matrix Only)** (Microscan Symbol Quality Output)
- **Pixels Per Element (Data Matrix Only)** (Microscan Symbol Quality Output)
- **Error Correction Level (Data Matrix Only)** (Microscan Symbol Quality Output)
- **Matrix Size (Data Matrix Only)** (Microscan Symbol Quality Output)
- **Detailed No Read Message** (No Read Message)
- **Bad Symbol Message**
- **No Symbol Message**
- **1D/Stacked Symbology Qualification**
- **2D Symbology Qualification**

Both Standard Mode and Q-Mode

In **Both**, the imager attempts to process the image using both Standard Mode and Q-Mode.

Fast Linear Mode (FLM) Direction

Definition: This mode assumes that the whole image is the candidate, and reads the image either horizontally or vertically. When the number of symbols in the field of view <K518> is set to 2, **Fast Linear Mode** will try to locate the candidates first and then decode. The candidate symbols cannot be side-by-side—they must be parallel.

Usage: <K527, IP Mode, **FLM direction**>

Default: **Auto**

Options: **0 = Auto** 1 = Horizontal 2 = Vertical

Auto

The imager tries to read both horizontally and vertically. It decides which direction to process first based on Window of Interest dimensions. For example, if the WOI height is greater than its width, the imager attempts to read vertically first, and if there is no decode, then it attempts to read horizontally.

Horizontal

This setting forces the imager to read horizontally.

Vertical

This setting forces the imager to read vertically.

Hollow Mode

Usage: Used to determine which kind of Data Matrix elements will be processed.

Definition: When set to **Regular Elements**, the imager will decode Data Matrix symbols with solid elements but will not decode Data Matrix symbols with hollow elements. When set to **Hollow Elements**, the imager will decode Data Matrix symbols with outlined, hollow elements but will not decode Data Matrix symbols with solid elements.

Serial Cmd: **<K517,hollow mode status>**

Default: **Regular Elements**

Options: **0 = Regular Elements** 1 = Hollow Elements

Note: **Hollow Mode** is not supported when **Q-Mode** is enabled.

The image below is an example of a Data Matrix symbol with hollow elements.

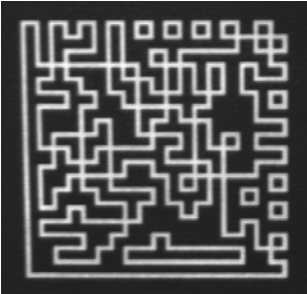

Mirrored Image

- Usage:* Enable this setting when the imager is viewing a mirrored image (as when it is being used with a right-angle mirror attachment).
- Definition:* When enabled, outputs a mirrored image of the symbol.
- Serial Cmd:* **<K514,mirrored image>**
- Default:* **Both (auto-detect)**
- Options:* 0 = Regular Image
1 = Mirrored Image
2 = Both (auto-detect normal/mirrored)

Regular Image

When **Regular Image** is enabled, images will be processed as they appear upon capture.

Mirrored Image

When **Mirrored Image** is enabled, images will be processed as a reverse of the captured image.

Both Regular and Mirrored

When **Both** is enabled, regular and mirrored images will be processed.

Illumination Brightness

Definition: This feature allows the user to adjust the brightness of the illumination LEDs. Since the imager has control over the brightness of the illumination, it can provide consistent brightness output between imagers through a factory calibration operation. Each of the brightness settings is calibrated to provide the same level of intensity for each imager.

Usage: <K536,brightness>

Default: **High**

Options: 0 = Off
1 = Low
2 = Medium
3 = High
4 = Constant

Constant

When set to **Constant**, the illumination is the same as the Medium setting. However, the LEDs will always be on during a read cycle and will only be off between read cycles. This cuts down on perceptible LED flashing.

Color Processing

Definition: The Quadrus MINI 3's image sensor captures images in color and then processes them for optimal decode performance. Color image processing requires image captures to be filtered, or the R, G, and B cells to be equalized. This is achieved by applying one of the available filters, or by performing a white balance with the current camera configuration before attempting to decode a symbol. This option specifies the filter method that is applied to the RGB color image to produce a monochrome image.

Usage: **<K543,color filter>**

Default: **General Purpose**

0 = Disabled

Options: **1 = General Purpose**

2 = Horizontal Linear (1D) Symbols

Disabled

When **Color Processing** is disabled, no filter is applied to the captured image. If you are attempting to decode symbols without a filter, a White Balance may be required to balance the red, green, and blue cells of the image sensor.

General Purpose

When enabled, the **General Purpose** filter is applied to the captured RGB image to produce a gray scale image. The gray scale image can be used in most applications, but the filtering process increases processing time.

The **General Purpose** filter should be used when reading 2D symbols, linear symbols that are not positioned horizontally in the field of view, or a combination of both.

Horizontal Linear (1D) Symbols

When enabled, the filter for **Horizontal Linear (1D) Symbols** is applied to the captured RGB image to produce a gray scale image that is designed specifically to provide the best suitable image for a linear symbol that is horizontally positioned in the field of view.

The **Horizontal Linear (1D) Symbols** filter should be used when reading linear symbols that are positioned horizontally in the field of view.

Skew Correction

The Quadrus MINI 3's CMOS image sensor has a "rolling shutter" mechanism that controls pixel integration row-by-row, unlike a global shutter, which performs light integration of all pixels at once. When a row of pixels has integrated light for the amount of time specified by the user-defined shutter speed, that row will be read out. The rows of the image are exposed individually in rapid sequence. As a symbol moves through the field of view, it is in a different position at each row read-out. This creates distortion, or "skew", as in the image shown below. In this image, the symbol is moving from left to right at a line speed of 40 inches per second. The bottom of the symbol is read out first while the upper portion is still being integrated, causing distortion along the symbol's **x-axis**.

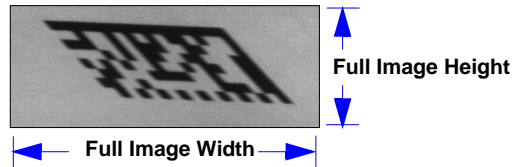

Note: The amount of blur in the image is an effect of shutter speed, and is not a factor in rolling shutter distortion.

If the symbol enters the imager's field of view from the top or bottom, distortion will occur on the **y-axis**. The image below shows two symbols entering the field of view from the top at different line speeds. As you can see, this causes the image to shrink along the **y-axis**. This is because the symbol is moving perpendicular to the CMOS sensor's row read-out. In other words, the bottom of the symbol is read out first, and as the symbol moves information is lost (the symbol enters pixel rows that have already been processed). This causes the symbol to appear to shrink vertically.

Note: If the symbol were to enter the field of view from the bottom, the captured image would be stretched along the **y-axis**.

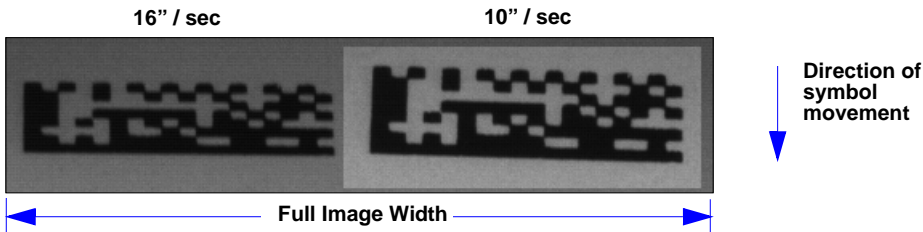

The amount of rolling shutter distortion depends upon the amount of time it takes to read out an image row, and the line speed at which the target object is traveling. Therefore, one way to reduce skew is to speed up the read-out time per pixel row. This can be accomplished by reducing the column size of the image sensor.

For example, if the column size is reduced from 640 to 320, the time it takes to read out a row of pixels from the sensor is reduced by half, and image skew will be reduced by a factor of 2. As the column dimension of the image is reduced, the effect of rolling shutter distortion is reduced by the same factor.

Important: Reducing the row size of the image has no effect, because it does not change the row read-out time. Skew will remain the same regardless of row size.

Line Speed

Definition: This feature is used to specify the line speed of the application, and it determines how much distortion correction to apply. When enabled, this feature will cause the overall decode rate to increase significantly. The timing information in the table below is for a full 3 megapixel image (2048 x 1536).

Note: Processing time decreases with larger image sizes.

Usage: <K537, **line speed**, symbol direction>

Default: **0 (Disabled)**

Options: 0 to 80 (inches per second)

Line Speed	Additional Processing Time
10" / sec	69.5 ms
20" / sec	65.0 ms
30" / sec	62.5 ms
40" / sec	58.0 ms
60" / sec	55.0 ms
80" / sec	45.5 ms

Distortion is corrected by shifting image rows in the direction opposite the symbol's movement on the line. The shift value of subsequent image rows is then increased. These shift values depend on the speed of the line. The faster the line speed, the greater the required shift values. More data loss is incurred at faster line speeds.

The image shown below was captured at a line speed of 40 inches per second, and it shows virtually no inherent skew. The black area of the image is unusable, since the information was lost as the symbol moved through the imager's field of view.

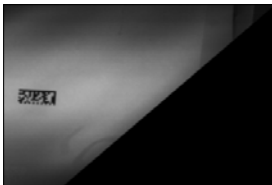

The amount of data loss can be reduced by decreasing the image height or the row size of the image, which reduces the amount of travel represented during the image frame read-out. Note that the amount of distortion will not be changed, because the object will have traveled the same distance during the read-out of the target area.

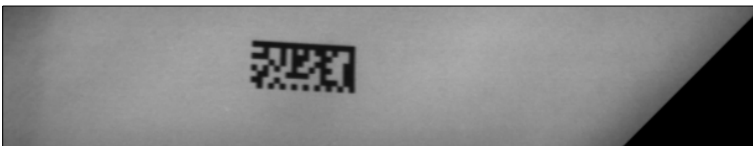



11 Configuration Database

Contents

- Configuration Database Serial Commands 11-2
- Number of Active Indexes 11-3
- Configuration Database Status..... 11-4
- Database Mode 11-11
- Save Current Settings to Configuration Database..... 11-16
- Load Current Settings from Configuration Database..... 11-17
- Request Selected Index Settings 11-18
- Request All Configuration Database Settings 11-19

This section concerns the various capture settings and processing settings that can be used to fine-tune the Quadrus MINI 3 Imager's performance in your application.

Configuration Database Serial Commands

Number of Active Indexes	<K252,number of active database settings,database sort>
Configuration Database Status	<K255,index,shutter speed,gain,focal distance,digital zoom,row pointer,column pointer,row depth, column width,threshold mode,fixed threshold value,processing mode,narrow margins,background color,symbology>
Save Current Settings to Database	<K255+,index>
Load Current Settings from Database	<K255-,index>
Request Selected Index Settings	<K255?,index>
Request All Database Settings	<K255?>
Database Mode	<K256,switch mode,frame count/time,image process looping,image dimensions>

Number of Active Indexes

Usage: Useful for applications that require several different complex imager configurations to be applied sequentially. Multiple database indexes allow you to concatenate configuration profiles, and to perform more complex operations than would be possible with only one set of configuration parameters.

Definition: This feature allows you to set the number of database records (groups of settings) that will be used automatically during the read cycle. If **Number of Active Indexes** is set to 0, only the current imager settings will be used, not database entry settings.

Serial Cmd: <K252,number of active indexes,database sort>

Default: 0 (disabled)

Options: 0 to 10

Database Sort

Definition: **Database Sort** moves the database entry that produced a successful decode to the first position in the list of database entries.

Serial Cmd: <K252,number of active indexes,database sort>

Default: Disabled

Options: 0 = Disabled 1 = Enabled

Number of Active Indexes by ESP

Click the arrow on the **Active Indexes** dropdown menu and select how many database indexes will be used during the read cycle. (0 to 10).

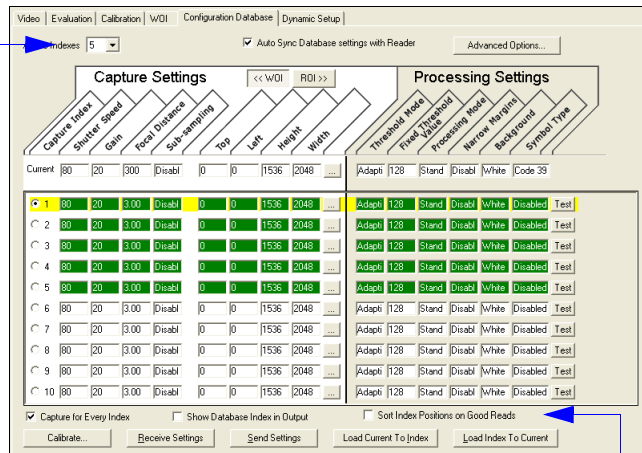

Sort Index Positions on Good Reads moves the database entry that produces the first successful decode to the top of the list.

Configuration Database Status

Index

Usage: Useful for applications that require several different complex imager configurations to be applied sequentially. Multiple database indexes allow you to concatenate configuration profiles, and to perform more complex operations than would be possible with only one set of configuration parameters.

Definition: Determines the specific database index that will be used.

Serial Cmd: <**K255,index**,shutter speed,gain,focal distance,sub-sampling,row pointer,column pointer,row depth,column width,threshold mode,fixed threshold value,processing mode,narrow margins,background color,symbology>

Options: 1 to 10

Shutter Speed

Serial Cmd: <**K255,index,shutter speed**,gain,focal distance,sub-sampling,row pointer,column pointer,row depth,column width,threshold mode,fixed threshold value,processing mode,narrow margins,background color,symbology>

Default: **250**

Options: 15 to 15,000

Gain

Serial Cmd: <**K255,index,shutter speed,gain**,focal distance,sub-sampling,row pointer,column pointer,row depth,column width,threshold mode,fixed threshold value,processing mode,narrow margins,background color,symbology>

Default: **20**

Options: 0 to 48

Focal Distance

Serial Cmd: <**K255,index,shutter speed,gain,focal distance**,sub-sampling,row pointer,column pointer,row depth,column width,threshold mode,fixed threshold value,processing mode,narrow margins,background color,symbology>

Default: **400** (4")

Options: 200 to 600 (Standard Density)

200 to 500 (Microdensity)

Pixel Sub-Sampling

Serial Cmd: <**K255**,index,shutter speed,gain,focal distance,**sub-sampling**,row pointer,column pointer,row depth,column width,threshold mode,fixed threshold value,processing mode,narrow margins,background color,symbology>

Default: **Disabled**

Options: **0 = Disabled** 1 = 4:1 2 = 16:1

Important: Sub-sampling has no effect when the **Image Dimension** mode is configured as **Region of Interest** in the **Database Mode** command. This is because the **Window of Interest** camera settings are determined by the software based on the **Region of Interest** setup. There is no benefit to sub-sampling to increase processing speed when ROI is configured, because the frame size would need to be increased to make sub-sampling possible.

Row Pointer

Definition: The image dimension settings can be applied as a Window of Interest or a Region of Interest, depending on the image dimension mode selected in the **Database Mode** command.

Serial Cmd: <**K255**,index,shutter speed,gain,focal distance,**sub-sampling**,**row pointer**,column pointer,row depth,column width,threshold mode,fixed threshold value,processing mode,narrow margins,background color,symbology>

Default: **0**

Options: 0 to (1536-row depth)

Column Pointer

Definition: The image dimension settings can be applied as a Window of Interest or a Region of Interest, depending on the image dimension mode selected in the **Database Mode** command.

Serial Cmd: <**K255**,index,shutter speed,gain,focal distance,**sub-sampling**,row pointer,**column pointer**,row depth,column width,threshold mode,fixed threshold value,processing mode,narrow margins,background color,symbology>

Default: **0**

Options: 0 to (2048-column width)

Row Depth

Definition: The image dimension settings can be applied as a Window of Interest or a Region of Interest, depending on the image dimension mode selected in the **Database Mode** command.

Serial Cmd: <K255,index,shutter speed,gain,focal distance,pixel binning,row pointer,column pointer,row depth,column width,threshold mode,fixed threshold value,processing mode,narrow margins,background color,symbology>

Default: 480

Options: 3 to (480 – row pointer)

Column Width

Definition: The image dimension settings can be applied as a Window of Interest or a Region of Interest, depending on the image dimension mode selected in the **Database Mode** command.

Serial Cmd: <K255,index,shutter speed,gain,focal distance,pixel binning,row pointer,column pointer,row depth,column width,threshold mode,fixed threshold value,processing mode,narrow margins,background color,symbology>

Default: 752

Options: 8 to (752 – column pointer)

Threshold Mode

Note: **Threshold Mode** is not supported when **Q-Mode** is enabled.

Serial Cmd: <K255,index,shutter speed,gain,focal distance,pixel binning,row pointer,column pointer,row depth,column width,threshold mode,fixed threshold value,processing mode,narrow margins,background color,symbology>

Default: Adaptive

Options: 0 = Adaptive 1 = Fixed

Fixed Threshold Value

Note: **Fixed Threshold Value** is not supported when **Q-Mode** is enabled.

Serial Cmd: <K255,index,shutter speed,gain,focal distance,pixel binning,row pointer,column pointer,row depth,column width,threshold mode,fixed threshold value,processing mode,narrow margins,background color,symbology>

Default: 128

Options: 0 to 255

Processing Mode

Important: Options **2** and **3** are not available in non-Q-Mode imagers.

Serial Cmd: <**K255**,index,shutter speed,gain,focal distance,pixel binning,row pointer,column pointer,row depth,column width,threshold mode,fixed threshold value,**processing mode**,narrow margins,background color,symbology>

Default: **Standard**

Options: **0 = Standard** 1 = Fast Linear Mode 2 = Q-Mode

Note: The following items are not supported when **Q-Mode** is enabled:

- **Hollow Mode**
- **Number of Symbols in Field of View**
- **Damaged Symbol**
- **IP Threshold**
- **BC412 Symbology**
- **2D Enhanced** (Narrow Margins)
- **Large Intercharacter Gap (Code 39)**
- **Large Intercharacter Gap (Codabar)**
- **Guard Bar Status (Interleaved 2 of 5)**
- **Codeword Collection (PDF417)**
- **Print Growth** (ISO/IEC 16022 Symbol Quality Output)
- **Axial Non-Uniformity (Data Matrix Only)** (ISO/IEC 16022 Symbol Quality Output)
- **Unused Error Correction (Data Matrix Only)** (ISO/IEC 16022 Symbol Quality Output)
- **Percent Cell Damage (Data Matrix Only)** (Microscan Symbol Quality Output)
- **Pixels Per Element (Data Matrix Only)** (Microscan Symbol Quality Output)
- **Error Correction Level (Data Matrix Only)** (Microscan Symbol Quality Output)
- **Matrix Size (Data Matrix Only)** (Microscan Symbol Quality Output)
- **Detailed No Read Message** (No Read Message)
- **Bad Symbol Message**
- **No Symbol Message**
- **1D/Stacked Symbology Qualification**
- **2D Symbology Qualification**

Narrow Margins

Serial Cmd: <**K255**,index,shutter speed,gain,focal distance,pixel binning,row pointer,column pointer,row depth,column width,threshold mode,fixed threshold value,processing mode,**narrow margins**,background color,symbology>

Default: **Disabled**

Options: **0 = Disabled** 1 = Enabled **2 = 2D Enhanced**

Background Color

Serial Cmd: <**K255**,index,shutter speed,gain,focal distance,sub-sampling,row pointer,column pointer,row depth,column width,threshold mode,fixed threshold value,processing mode,narrow margins,**background color**,symbology>

Default: **Both**

Options: 0 = White 1 = Black **2 = Both**

Symbology

Definition: This field allows the user to configure the database to enable specific symbologies for selected database indexes. Symbology-specific parameters must be configured with the appropriate symbology command.

For example, if fixed length Code 128 is required, it must first be set up with the Code 128 command: <**K474**>.

To select a particular symbology, add the number value associated with that symbology type.

Examples:

If Data Matrix and Code 39 are required, the parameter would be: 2 + 16 = **18**.

If I 2/5, BC412, and DataBar Limited (RSS Limited) are required, the parameter would be: 128 + 2048 + 16384 = **18560**.

Serial Cmd: <**K255**,index,shutter speed,gain,pixel binning,row pointer,column pointer,row depth,column width,threshold mode,fixed threshold value,processing mode,narrow margins,**background color**,**symbology**>

Default: **Disabled**

Disabled

When **Symbology Type** is disabled, the database uses the current **Symbology Type** setup to determine active symbologies.

Any Symbology (Add 1)

All symbologies *except* *Pharmacode* are enabled while this database index is being used.

Data Matrix (Add 2)

If enabled, Data Matrix will be active for this database index.

Important: The ECC level must be configured using the Data Matrix command <**K479**>. If no ECC level has been configured, the imager will not decode Data Matrix symbols.

QR Code (Add 4)

If enabled, QR Code will be active for this database index.

Code 128 (Add 8)

If enabled, Code 128 will be active for this database index.

Code 39 (Add 16)

If enabled, Code 39 will be active for this database index.

Codabar (Add 32)

If enabled, Codabar will be active for this database index.

Code 93 (Add 64)

If enabled, Code 93 will be active for this database index.

Interleaved 2 of 5 (Add 128)

If enabled, Interleaved 2 of 5 will be active for this database index.

UPC/EAN (Add 256)

If enabled, UPC/EAN will be active for this database index.

PDF417 (Add 512)

If enabled, PDF417 will be active for this database index.

MicroPDF417 (Add 1024)

If enabled, MicroPDF417 will be active for this database index.

BC412 (Add 2048)

If enabled, BC412 will be active for this database index.

Note: BC412 is not supported when **Q-Mode** is enabled.

Pharmacode (Add 4096)

If enabled, Pharmacode will be active for this database index.

DataBar-14 (RSS-14) (Add 8192)

If enabled, DataBar-14 will be active for this database index.

Important: If the stacked and non-stacked operation is required, the DataBar-14 command must be configured as follows: **<K482,2>**. If the DataBar-14 status parameter in the **<K482>** command is set to either DISABLED or ENABLED, the imager will only read non-stacked DataBar-14 symbols.

DataBar Limited (RSS Limited) (Add 16384)

If enabled, DataBar Limited will be active for this database index.

DataBar Expanded (RSS Expanded) (Add 32768)

If enabled, DataBar Expanded will be active for this database index.

Important: If the stacked and non-stacked operation is required, the DataBar Expanded command must be configured as follows: **<K484,2>**. If the DataBar Expanded status parameter in the **<K484>** command is set to either DISABLED or ENABLED, the imager will only read non-stacked DataBar Expanded symbols.

Micro QR Code (Add 65536)

If enabled, Micro QR Code will be active for this database index.

Note: Micro QR Code is only supported when **Q-Mode** is enabled.

Aztec Code (Add 131072)

If enabled, Aztec Code will be active for this database index.

Note: Aztec Code is only supported when **Q-Mode** is enabled.

Postal Symbologies (Add 262144)

If enabled, Postal Symbologies will be active for this database index.

Note: Postal Symbologies are only supported when **Q-Mode** is enabled.

Database Mode

Switch Mode

Definition: Selects the event that causes the imager to load the next database entry to current, active settings. When **Frame Count/Time** expires and **Image Process Looping** is enabled, the next database entry with modifications to camera settings will be used.

Note: The image capture event always occurs when the first database entry is used.

Note: The **Switch Mode** setting has no effect on **Rapid Capture Mode**, which always operates in **Number of Image Frames** mode with a frame count of 1.

Serial Cmd: <K256,switch mode,frame count/time,image process looping,image dimensions>

Default: 1

Options: 0 = Time **1 = Number of Image Frames**

Time

When **Switch Mode** is set to **Time**, the imager will load the next database entry to current, active settings after a predefined time interval. The timer will start upon use of a database entry. If the timer expires during an image capture event, the timer will not start again until that database entry has been incremented and the new database entry has been loaded to current, active settings.

Number of Image Frames

When **Switch Mode** is set to **Number of Image Frames**, the database entry is incremented after the predetermined number of image capture events has occurred.

Frame Count/Time

Definition: Indicates the **Number of Image Frames** that must be captured or the amount of **Time** that must transpire before the imager will load the next database index entry.

Serial Cmd: <K256,switch mode,frame count/time,image process looping,image dimensions>

Default: 1 (frames/ms)

Options: 1 to 65535

Image Process Looping

Usage: Useful in applications where it is necessary to process a single captured image multiple times using different IP and decode parameters.

Serial Cmd: <K256,switch mode,frame count/time,**image process looping**,image dimensions>

Default: **Disabled**

Options: **0 = Disabled** 1 = Enabled

Disabled

When **Image Process Looping** is set to **Disabled**, an image is captured for every database configuration, whether or not any camera settings have been modified.

Enabled

When **Image Process Looping** is set to **Enabled**, the last captured image frame is re-processed with the new IP and decode parameters. If camera settings have not been changed from the last capture event, and when a database configuration is loaded to current, active settings, no new image is captured.

Note: An exception to this is the first database index: a new image is always captured when the first database index is used. When a camera setting has been modified from one database setting to the next, a new image is captured. For example, if all database entries contained the same camera setting values but had different IP and decode parameters, an image frame would only be captured when the first database configuration was used.

Image Dimensions

Definition: Determines how the image dimension parameters will be implemented.

Serial Cmd: <K256,switch mode,frame count/time,image process looping,**image dimensions**>

Default: 0

Options: 0 = Window of Interest 1 = Region of Interest

Window of Interest (WOI) by ESP

When **Image Dimensions** is set to **Window of Interest**, the database image dimension parameters are *camera settings*, and they determine the size of the image to be captured.

The screenshot shows the 'Configuration Database' window with the 'WOI' tab selected. The interface is divided into 'Capture Settings' and 'Processing Settings'. A table lists various camera settings for different indices. A red box highlights the row for index 1, which is selected. A blue arrow points to the 'Capture for Every Index' checkbox, which is checked.

Index	Capture Index	Shutter Speed	Gain	Focal Distance	Sub-sampling	Top	Left	Height	Width	Processing Mode	Threshold	Fixed Value	Processing Mode	Narrow Margins	Background	Symbol Type
Current	80	20	300	Disabl	0	0	1536	2048	...	Adapti	128	Stand	Disabl	White	Code 39	
1	80	20	3.00	Disabl	0	0	1536	2048	...	Adapti	128	Stand	Disabl	White	Disabled	Test
2	80	20	3.00	Disabl	0	0	1536	2048	...	Adapti	128	Stand	Disabl	White	Disabled	Test
3	80	20	3.00	Disabl	0	0	1536	2048	...	Adapti	128	Stand	Disabl	White	Disabled	Test
4	80	20	3.00	Disabl	0	0	1536	2048	...	Adapti	128	Stand	Disabl	White	Disabled	Test
5	80	20	3.00	Disabl	0	0	1536	2048	...	Adapti	128	Stand	Disabl	White	Disabled	Test
6	80	20	3.00	Disabl	0	0	1536	2048	...	Adapti	128	Stand	Disabl	White	Disabled	Test
7	80	20	3.00	Disabl	0	0	1536	2048	...	Adapti	128	Stand	Disabl	White	Disabled	Test
8	80	20	3.00	Disabl	0	0	1536	2048	...	Adapti	128	Stand	Disabl	White	Disabled	Test
9	80	20	3.00	Disabl	0	0	1536	2048	...	Adapti	128	Stand	Disabl	White	Disabled	Test
10	80	20	3.00	Disabl	0	0	1536	2048	...	Adapti	128	Stand	Disabl	White	Disabled	Test

Capture for Every Index
 Show Database Index in Output
 Sort Index Positions on Good Reads

Camera settings (**Capture Index, Shutter Speed, Gain, Focal Distance, Sub-Sampling**) located in the left half of the highlighted area.

Image capture dimensions (**Row Pointer, Column Pointer, Row Depth, Column Width**) located in the right half of the highlighted area.

Region of Interest (ROI)

When **Image Dimensions** is set to Region of Interest, the database image dimension parameters are *IP and decode settings*, and they determine the region or area of the captured image to be processed.

ROI coordinate data is based on the full image size. The **WOI** of the captured image will be configured to cover all the ROI settings in the current, active database entry. In the following example, there are three active database settings, each with a different ROI configuration. Their coordinates are based at point 0,0 of the full scale image (2048 x 1536). In this example, **DB1** and **DB3** determine the size of the captured image WOI, while DB2 has no impact. The image WOI is not configurable. It is automatically set up by the database according to the ROI settings.

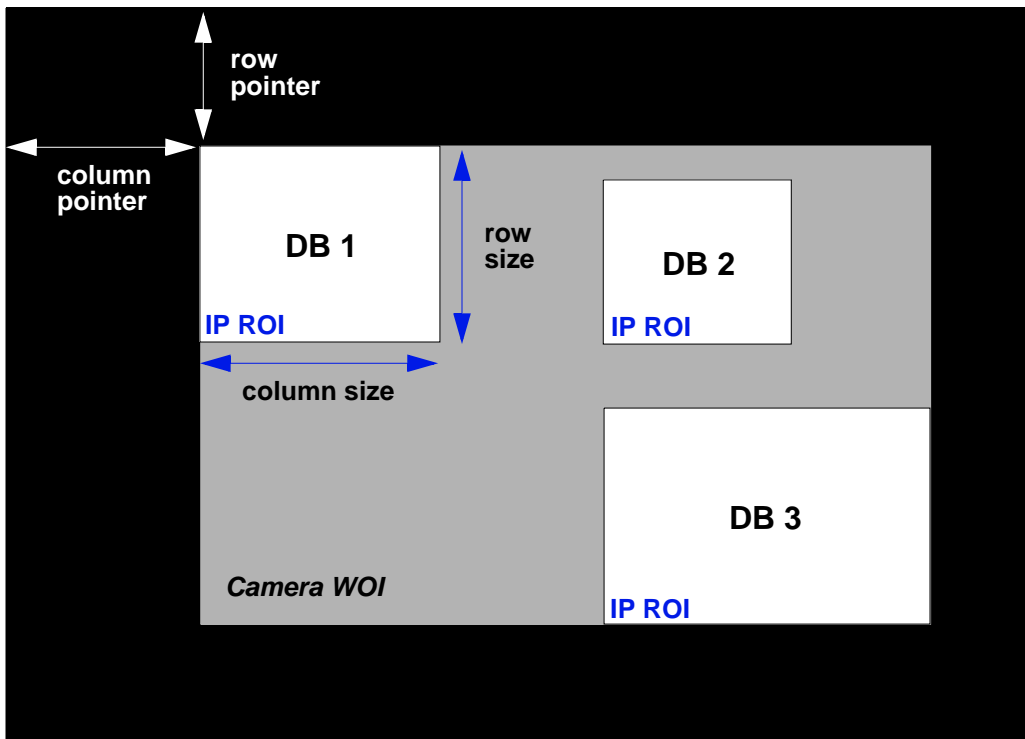

Full Image Size (2048 x 1536)

Note: Since the **ROI** parameters are not a camera setting, a change in **ROI** parameters from one index to another does *not* indicate an image capture event.

This feature is intended to be used in conjunction with **Image Process Looping**, to allow different regions of a captured image to be processed using different IP and decode settings.

Also, if this feature is used in conjunction with **Output Filtering**, multiple decoded symbols in a captured image frame can be output according to their location in the field of view.

Region of Interest (ROI) by ESP

When **Image Dimensions** is set to Region of Interest, the database image dimension parameters are *IP and decode settings*, and they determine the region or area of the captured image to be processed.

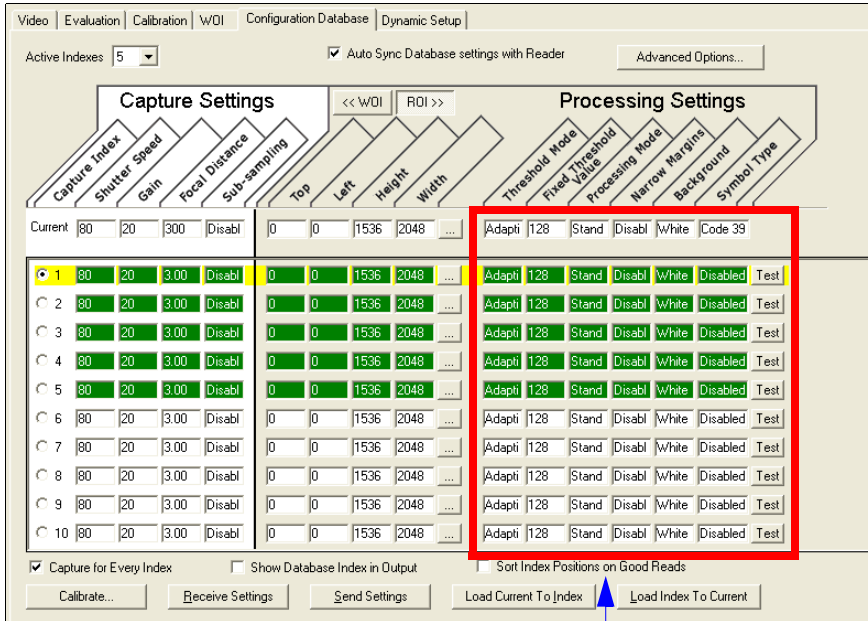

Threshold Mode, Fixed Threshold Value, Processing Mode, Narrow Margins, Background, and Code Type are all Processing Settings values.

Save Current Settings to Configuration Database

Definition: Allows current, active configuration settings to be saved to a selected database index.

Serial Cmd: <K255+,index>

Example:

<K255+,5>

This command phrase saves the imager’s current, active configuration settings to database index 5.

Save Current Settings to Configuration Database by ESP

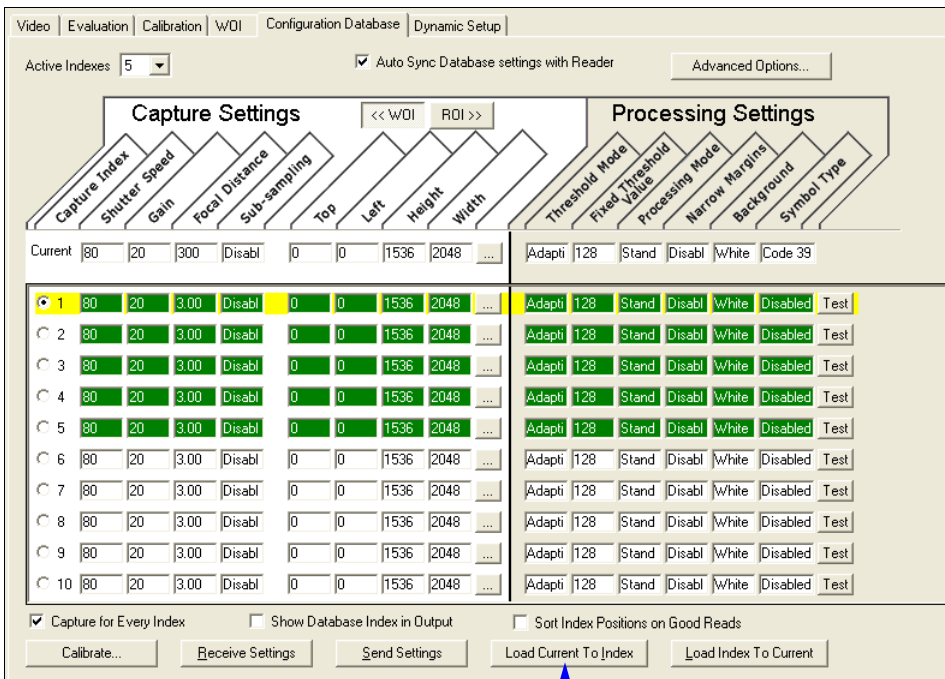

Click the **Load Current to Index** button to save the imager’s current configuration parameters to the selected database index.

Load Current Settings from Configuration Database

Definition: Allows the configuration settings contained in a selected database index to be loaded to current, active configuration settings.

Serial Cmd: <K255-,index>

Example:

<K255-,5>

This command phrase loads the configuration settings contained in database index 5 to current, active configuration settings.

Load Current Settings from Configuration Database by ESP

The screenshot shows the 'Configuration Database' window with a table of settings. The table has columns for 'Current' and 'Processing Settings'. The 'Current' column has sub-columns for 'Gain', 'ROI', 'Adapt', 'Stand', 'Disabl', and 'White'. The 'Processing Settings' column has sub-columns for 'Adapt', 'Stand', 'Disabl', 'White', 'Disabled', and 'Test'. The table contains 10 rows of data, with the first row highlighted in green. A blue arrow points to the 'Load Index To Current' button at the bottom right of the table.

Click the **Load Index to Current** button to load configuration settings from the selected index to current, active settings.

Notes on Symbol Type

- The **current** DataBar Expanded status does not change if it is configured as Enabled (Stacked) and the **database** DataBar Expanded status is Enabled.
- The **current** DataBar-14 status does not change if it is configured as Enabled (Stacked) and the **database** DataBar Expanded status is Enabled.
- Data Matrix ECC level is determined by the **current** settings and not by **database** settings. Therefore, the database does not know which ECC level to enable, and has no effect on current Data Matrix ECC settings.

Request Selected Index Settings

Definition: Returns configuration settings for the selected database index.

Serial Cmd: **<K255?,index>**

Example:

<K255?,5>

This command phrase returns the configuration settings for database index 5.

Request All Configuration Database Settings

Definition: Returns configuration settings for all indexes in the configuration database.

Serial Cmd: <K255?>

Example:

<K255?>

This command phrase returns the configuration settings for all 10 database indexes.



12 Terminal

Contents

Terminal Window.....	12-2
Find	12-3
Send	12-4
Macros.....	12-5
Terminal Window Menus.....	12-6

This section describes the **Terminal** window and macro functions in **ESP**.

Terminal Window



Click this button to bring up the **Terminal** view.

The following window will appear:

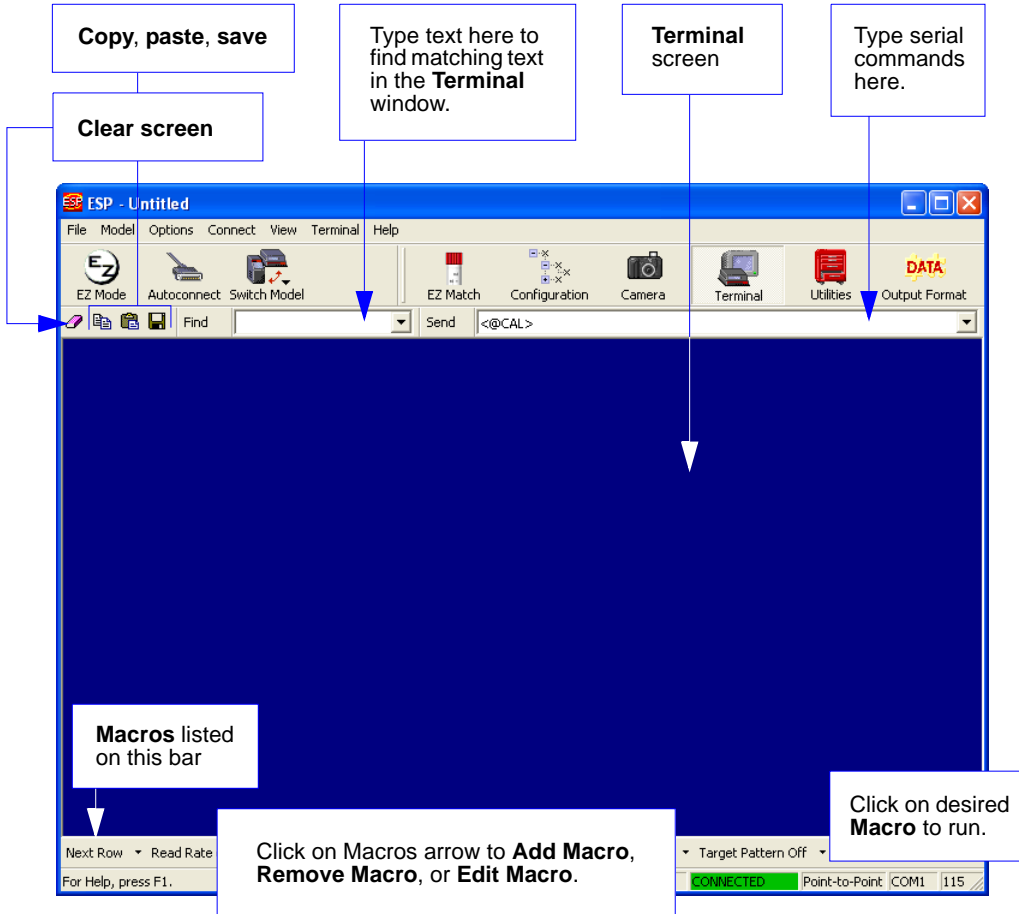

The **Terminal** screen allows you to send serial commands to the imager by using Macros, by copying and pasting, or by typing commands in the **Send** text field.

The **Terminal** screen also displays symbol data or information from the imager.

You can also right-click on the **Terminal** screen to bring up a menu of further options.

Find

The **Find** function allows you to enter text strings to be searched for in the **Terminal** window. For example, a series of symbols have been scanned into the **Terminal** view and you want to determine if a particular symbol whose data begins with “ABC” has been read.

1. Type “ABC” into the **Find** box.

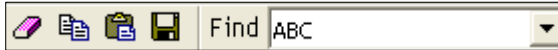

2. Press **Enter**.

The first instance of “ABC” will be highlighted in the **Terminal** window.

3. Click the **Find** button to the left of the text field to locate additional instances of “ABC”.

Send

The **Send** function allows you to enter serial commands and then send them to the imager.

1. Type the command into the **Send** box.

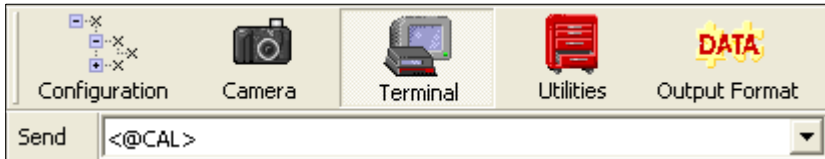

2. Press **Enter**.
3. Click the **Send** button to the left of the text field to send .

Macros

Macros can be stored in a macro selection bar, edited in a separate window, and executed by clicking on the macro name.

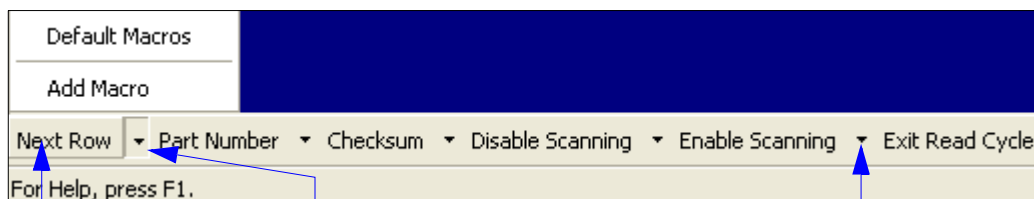

Click on **Next Row** to see the next row of macros

Click on the first arrow here to see **Add Macro** or **Default Macros**. When you default macros, the entire macros set is restored to their original macro commands.

Click on subsequent arrows to edit macros.

When you click on the macro name, the macro is executed in the **Terminal** window. If this is a command, it is sent to the reader at the same time that it is displayed.

Editing a Macro

When you click the arrow next to any macro and select **Edit**, the following appears:

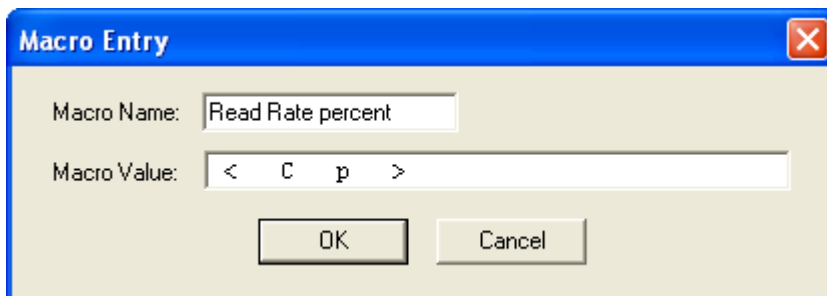

You can edit an existing macro or type in the **Macro Name** text field and define it in the **Macro Value** text field. Click **OK**.

Terminal Window Menus

Right-click on the **Terminal** window to display the following menu:

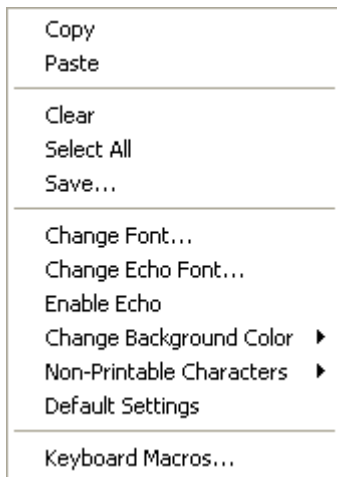

- **Copy** selected text to clipboard.
- **Paste** from Terminal or other text.
- **Clear** all text in Terminal window.
- **Select All** text in the Terminal window.
- **Save...** brings up a **Save As** dialog.
- **Change Font...** of text in Terminal; brings up a **Font** dialog.
- **Change Echo Font...** to change typed text; brings up a **Font** dialog.
- **Enable Echo** enables Echo text (typed by user).
- **Change Background Color** of Terminal window.
- **Non-Printable Characters** allows you to hide non-printable characters, or to show them in **Standard** or **Enhanced** format.
- **Default Settings** returns all the above settings to default.
- **Keyboard Macros** allows you to create new keyboard macro commands that can be sent from function keys (F2, F4, F5, etc.).

Terminal Dropdown Menu

The dropdown **Terminal** menu has **Capture Text**, **Save Current Text**, **Send File**, **Find Next**, and **Find Previous** functions, as well as the same functions defined above.

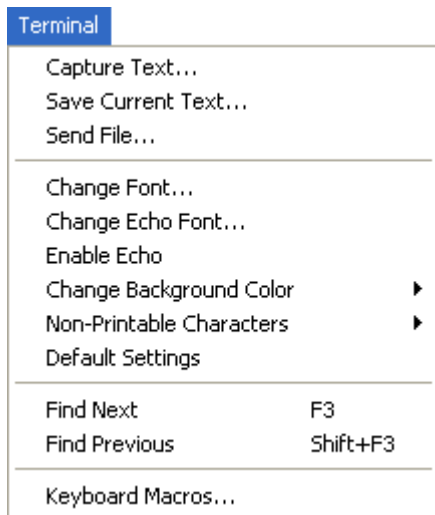

- **Capture Text...** lets you append data in real time to a text file of your choice. While in operation, the text file cannot be opened. You can select **Pause** to interrupt the capture flow or **Stop** to end the flow and open the file.
- **Save Current Text...** saves all text in the Terminal window to a text file.
- **Send File** allows you to browse for specific files and send them to the reader.
- **Find Next** searches for a user-defined section of text in the Terminal.
- **Find Previous** operates in the same way as Find Next, but searches backward through Terminal text.



13 Utilities

Contents

Serial Utility Commands	13-2
Read Rate	13-4
Counters	13-5
Device Control	13-7
Differences from Default	13-8
Master Database	13-9
Firmware.....	13-15
Default/Reset/Save.....	13-18
Imager Status Requests	13-20
Other Operational Serial Commands	13-22

Utility commands are generally commands that are performed during imager operations to check or determine read rates, or to perform miscellaneous operations on imager hardware. Serial utility commands are not prefaced with a "K" and a numeric code, nor do they require an initialization command (<A> and <Z>). They can be entered from within any terminal program or from **ESP's Terminal** or **Utilities** windows.

Serial Utility Commands

Note: For a list of all K commands, see [Serial Configuration Commands](#) on page A-6.

Type	Command	Name
Read Rate	<C>	Enter Decode Rate Test
	<Cp>	Enter Percent Rate Test
	<J>	Exit Decode Rate and Percent Rate Test
Counter Request and Clear	<N>	No Read Counter
	<O>	No Read Counter Reset
	<T>	Trigger Counter
	<U>	Trigger Counter Reset
	<V>	Good Read/Match Counter
	<W>	Good Read/Match Counter Reset
	<X>	Mismatch Counter
	<Y>	Mismatch Counter Reset
Master Database	<G>	Store Next Symbol Read to Database Index 1
	<Gn>	Store Next Symbol Read to Database Index <i>n</i>
	<NEWM>	New Master Load Status
Part Number / Checksum	<#>	Display All Firmware Part Numbers
	<#a>	Display Application Code Part Number
	<#b>	Display Boot Code Part Number
	<#p>	Display Profile Module Part Numbers
	<!>	Display All Available Firmware Checksums
	<!a>	Display Application Code Code Checksum
	<!b>	Display Boot Code Checksum
	<!p>	Display Profile Module Checksum
Device Control	<L1>	Programmable Output 1
	<L2>	Programmable Output 2
	<L3>	Programmable Output 3
	<11>	Targeting System On
	<10>	Targeting System Off
	<l>	Disable Imager
	<H>	Enable Imager
	<a1>	Include PDF Information in Preamble (PDF417)
Default/Reset/Save	<A>	Reset (does not save for power-on)
	<Ard>	Reset and Recall Microscan Defaults
	<ArdWB>	Reset and Recall Microscan White Balance Defaults
	<Arp>	Reset and Recall Power-On Parameters
	<Arc>	Reset and Recall Customer Default Parameters

Default/Reset/Save	<Z>	Save Current Settings for Power-On
	<Zc>	Save Current Settings as Customer Default Parameters for Power-On
	<Zrd>	Recall Microscan Default Parameters and Save for Power-On
	<ZrdWB>	Reset Microscan Default White Balance Parameters and Save for Power-On
	<Zrc>	Recall Customer Default Parameters and Save for Power-On
Imager Status Request Commands	<?>	Imager Status Byte
	<K?>	All Status Request
	<K??>	All Descriptor Status Request
	<K?#>	All Range Status Request
	<Knnn?>	Single Status Request
	<Knnn??>	Single Descriptor Status Request
	<Knnn?#>	Single Range Status Request
Other Operational Commands	<uy,path,filename>	Y-Modem Upload Transfer Options
	<dy,path,filename>	Y-Modem Download Transfer Options
	<op,9>	Image Library Request
	<@CAL>	Calibrate
	<BCCFG>	Enter Bar Code Configuration
	<VAL>	Static Validation
	<@WB>	White Balance Calibration

Read Rate



Click this button to bring up the **Utilities** view.

Read Rate by ESP

To see the number of decodes per second, click the **Decodes/sec** radio button on the **Read Rate** tab in the **Utilities** view and click the **Start** button.

To see the percentage of decodes, click the **Percent** radio button and then the **Start** button.

To end a Read Rate test, click the **Stop** button (the **Start** button becomes a “**Stop**” button during an active Read Rate test.)

Important: When Read Rate is enabled, the **Configuration Database** is not active, regardless of how the imager is configured.

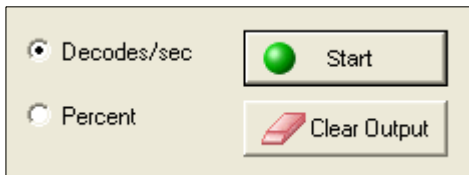

Read Rate by Serial Command

Enter Decodes/Second Test

Sending **<C>** instructs the imager to transmit the decodes per second and symbol data (if any). The decode rate can vary dramatically due to the angle and location of the symbol in relation to the field of view. This test is very useful in aligning and positioning the imager during setup.

Enter Percent Test

Sending **<Cp>** instructs the imager to transmit the percentage of decodes and any decoded symbol data.

End Read Rate Test

Sending **<J>** ends both the Percent test and the Decodes/Second test.

Counters

Counter commands can be a numeric value from **00000** to **65535**. After reaching the maximum numeric limit of 65535, an error message will be displayed and the counter will automatically roll over and start counting again at 00000. To obtain the cumulative total of counts after the rollover has occurred, add 65536 per each rollover (the imager does not keep track of the number of rollovers) to the current count.

Note: All counter values will be lost if power is recycled to the imager, or if the imager receives a **Reset** or **Save** command.

Counters by ESP

You can access **Counters** from **ESP's Utilities** menu.

Click the **Request** button to display the appropriate count or **Clear** to set the counter to zero.

The screenshot shows a software interface for managing counters. At the top, there are two large buttons: "Request All" and "Clear All". Below these are four rows of controls, each corresponding to a different counter type. Each row contains a "Request" button, a "Clear" button, and a text input field. The counter types are: "Trigger", "Good Read", "Noread", and "Mismatch".

Counter Type	Request	Clear	Value
Trigger	Request	Clear	Trigger: <input type="text"/>
Good Read	Request	Clear	Good Read: <input type="text"/>
Noread	Request	Clear	Noread: <input type="text"/>
Mismatch	Request	Clear	Mismatch: <input type="text"/>

Counters by Serial Command

No Read Counter

Sending **<N>** displays the total number of No Reads that have occurred since the last reset.

No Read Counter Reset

Sending **<O>** sets the No Read Counter to 00000.

Trigger Counter

Sending **<T>** displays the total number of triggers since the last reset.

Trigger Counter Reset

Sending **<U>** sets the trigger counter to 00000.

Good Read/Match Counter (or Good Read Counter)

Sending **<V>** displays the total number of good reads matching the master symbol, or, if **Master Symbol** is not enabled, the number of good reads since the last reset. This counter is always enabled, but will only work as a match count when **Master Symbol** is enabled. If **Master Symbol** is not enabled, this counter records the number of good reads. This count can be requested at any time.

Good Read/Match Counter Reset

Sending **<W>** sets the Match Counter to 00000.

Mismatch Counter

Sending **<X>** displays the number of decoded symbols since the last reset that do not match the master symbol.

Mismatch Counter Reset

Sending **<Y>** sets the Mismatch Counter to zero.

Device Control

Device Control by ESP

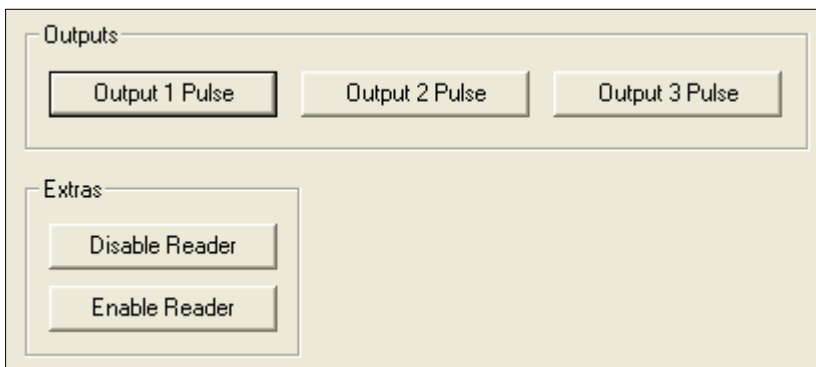

Device Control by Serial Command

Output 1 Pulse

Sending **<L1>** activates the link between Output 1 (+) and Output 1 (-) of the host connector (regardless of Master Symbol or Output 1 status).

Output 2 Pulse

Sending **<L2>** activates the link between Output 2 (+) and Output 2 (-) of the host connector (regardless of Master Symbol or Output 2 status).

Output 3 Pulse

Sending **<L3>** activates the link between Output 3 (+) and Output 3 (-) of the host connector (regardless of Master Symbol or Output 3 status).

Disable Reader

Sending **<I>** will turn the imager OFF, end the current read cycle, and will not allow the imager to enter another read cycle until turned ON. This feature is useful during extended periods of time when no symbols are being decoded, or the imager is being configured. Disabling the imager will not affect any commands that have already been downloaded.

Enable Reader

Sending **<H>** will turn the imager ON and allow it to enter read cycles.

Enable PDF Information

Sending **<a1>** will cause PDF417 data to be prefaced with information consisting of ECC level (ECC level *n*), number of rows (*n* rows), number of columns (*n* columns), number of informative code words (*n* info code words), and the number of data characters (*n* data bits). Send **<a1>** again to disable PDF Information.

Differences from Default

Clicking the **Differences from Default** button will cause **ESP** to check all stored configuration settings and compare them to default settings. All settings that are different than default will appear in the left column (shown below), and descriptions of those settings will appear in the right column.

Click this button for a list of **ESP** configuration settings that are different than default settings.

Click **Generate Barcode** to bring up the **Bar Code Dialog**. Then create configuration symbols containing the configuration commands of your choice.

Send configuration settings to the imager without saving by clicking **Send to Reader**.

Click **Save As** to save the report as plain text or a tab-delimited text file.

Send configuration settings to the imager and save in ESP by clicking **Send and Save**.

Setting	Description
<K200,4>	Mode (Serial Data)
<K201h,52>	Character (Delimited) (R)
<K220,,1000>	Read Cycle Timeout (1000)
<K470,0>	Code 39 (Disabled)
<K525,435>	Focus Distance (435)
<K529,,,1,0,,,2>	Focus Position (Calibrate)
	Symbol Type (Don't Calibrate)
	Processing (High)
<K541,,30>	Gain (30)
<K714h,,5a5a5a5a>	Message (ZZZZ)
<K715h,,5a5a5a5a>	Bad Symbol Message (ZZZZ)
<K716h,,5a5a5a5a>	No Symbol Message (ZZZZ)

- To create a symbol containing any of the command settings in the table, click **Generate Barcode**. This will bring up the **Bar Code Dialog**.
- To save the **Differences from Default** report, either as plain text or as a tab-delimited text file, click **Save As**.
- Click **Send and Save** to send the settings to the imager and save them, or **Send to Reader** to send the settings without saving them.

Important: The use the **Differences from Default** feature, you must connect to the imager and **Receive Reader Settings** via the **Send/Recv** button on the toolbar.

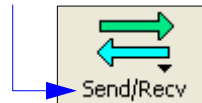

Master Database

Important: The **Master Database** is used for all **Matchcode** modes except **Sequential** and **Wild Card**, both of which use **Master Database Index # 1**.

Master Database Overview

Usage: Used where more than one master symbol is required, as in a **Multisymbol** setup, for matching and other **Matchcode** operations.

Definition: Allows the user to define up to 10 master symbols as the master symbol database, which can be entered by keyboard, scanned in, displayed, or deleted by serial or **ESP** commands.

1. Click the **Master Database** tab.
2. Enable **Matchcode Type**.
3. Set the **Master Symbol Database Size**.
4. Select the database index in which you want to enter the master symbol.
5. Do one of the following to enter master symbol data:
 - a. Double-click the index row to type data directly into the index.
 - b. Click the **Read Symbol into Selected Index** to enter the next decoded symbol.

The screenshot shows the Master Database configuration window. At the top, there is a 'Master Symbol Database Size' field with a spinner set to 3. To its right is a checked 'Matchcode Type' checkbox and a 'Read Symbol into Selected Index' button. Below these are 'Receive Reader's Database' and 'Send Database to Reader' buttons. A table below has columns 'Index' and 'Master Symbol Data' with rows 1, 2, and 3. A 'Caution' note at the bottom explains that changing the size re-allocates characters and may delete existing symbols.

Callouts in the image provide the following information:

- Set Master Symbol Database Size here.** (points to the spinner)
- Loads the next symbol decoded into the selected index.** (points to the 'Read Symbol into Selected Index' button)
- Double-click a row to enter data into popup dialog box.** (points to row 1)
- Loads the imager's saved master symbols into ESP.** (points to the 'Receive Reader's Database' button)
- Saves the displayed database to the imager.** (points to the 'Send Database to Reader' button)

Caution: Since the total number of characters available for the master symbol database is limited, changes to the Master Symbol Database Size will re-allocate the number of characters available for each master symbol and could cause existing master symbols to be deleted. See manual for details.

Master Symbol Database Size

Definition: **Number of Master Symbols** allows you to select 1 to 10 master symbols for the master symbol database.

Serial Cmd: **<K231, master symbol database size>**

Note: You must follow this command with a save command **<A>** or **<Z>**.

Default: **1**

Options: 1 to 10

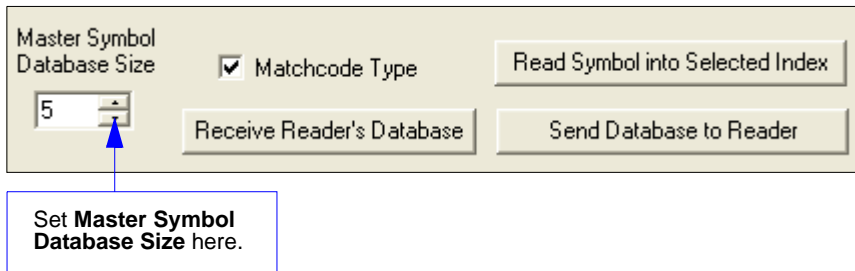

Caution: Since the total number of characters available for the master symbol database is **3000**, changes to the **Master Symbol Database Size** will re-allocate the number of characters available for each master symbol and could cause existing master symbols to be deleted (except master symbol #1, unless it also exceeds the size limitation).

The table below specifies the maximum number of characters available to each symbol according to the number of master symbols defined, from 1 to 10.

<i>Master Symbol Number</i>	<i>Maximum Characters</i>	<i>Master Symbol Number</i>	<i>Maximum Characters</i>
# 1	3000	# 6	500
# 2	1500	# 7	428
# 3	1000	# 8	375
# 4	750	# 9	333
# 5	600	# 10	300

Enter Master Symbol Data

Usage: Allows you to enter master symbol data for any enabled master symbol index number (1 to 10), provided the total number of characters does not exceed the maximum allowed.

Serial Cmd: <K231, master symbol number, master symbol data>

Options: Enter data for 1 to 10 symbols (any combination of ASCII text up to the maximum allowed).

For example, to enter data for master symbol 9, after making certain that master symbol database size is enabled for 9 or more symbols, send <K231,9,data>.

Important: The ASCII characters <, >, and , can only be entered as hex pairs. See [ASCII Character Entry Modifier](#) on page 3-32 for a detailed explanation of how to enter ASCII characters as hex values.

Caution: If no data is entered, the existing data will be deleted.

- ESP:**
1. Open the **Utilities** menu.
 2. Set the number of master symbols you want to create in **Master Symbol Database Size**.
 3. Double-click on each symbol number you want to set up and copy, or type your data in the popup dialog and click **OK**.

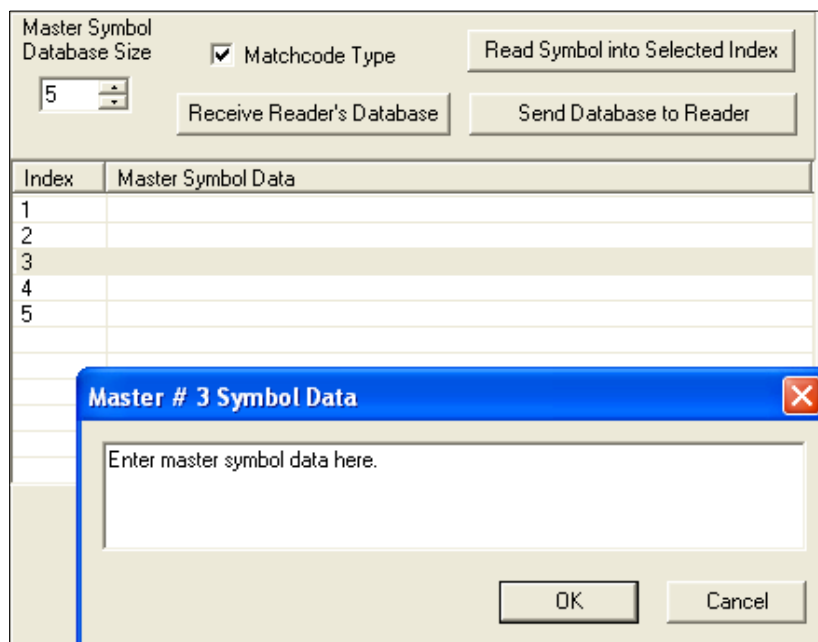

4. When all your data has been entered, click the **Send Database to the Reader** button.

Request Master Symbol Data

Definition: Returns master symbol data for any enabled master symbols from 1 to 10. For example, to request master symbol # 5, enter **<K231 ?,5>**. The imager transmits master symbol # 5 data in brackets in the following format: **<5/>**. If no master symbol data is available, the output will be: **<5/>**.

Serial Cmd: **<K231 ?,master symbol number>**

Caution: Be sure to add the **?** or you will delete the master symbol.

Note: This command returns the number of master symbols if no number is included.

- ESP:**
1. Click the **Utilities** button and the **Master Database** tab.
 2. Click the **Receive Reader's Database** button.

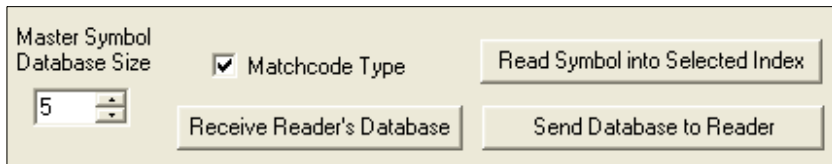

The screenshot shows a dialog box titled "Master Symbol Database Size". It contains a text input field with the number "5" and a small spinner icon to its right. To the right of the input field is a checked checkbox labeled "Matchcode Type". Further right is a button labeled "Read Symbol into Selected Index". Below the input field and checkbox are two buttons: "Receive Reader's Database" and "Send Database to Reader".

Request All Master Symbol Data

Definition: This command will return master symbol data for all symbols enabled (up to 10).

Serial Cmd: **<K231 ?>**

Read Next Symbol as Master Symbol

Definition: After you've set the size in the database, you can order the imager to read the next symbol as the master symbol for any given master symbol number.

Serial Cmd: **<Gmaster symbol number>**

To store the next symbol decoded as master symbol # 1, send:

<G> or **<G1>**.

To store the next symbol decoded as the master symbol for any other master symbol database number, send:

<Gmaster symbol number [1-10]>.

For example, **<G5>** will cause the next symbol read to be entered as master symbol # 5.

ESP: In the **Master Database** tab under the **Output Format** menu,

1. Select the master symbol index number in which you want to store the symbol data.
2. Click the **Read Symbol into Selected Index** button.

Caution: If you've selected an index which already has existing data, that data will be copied over by new decoded data when you use this command.

Request New Master Status

Usage: Informs the user when a new master symbol is pending and which position it is in.

Definition: Returns the position in the master symbol database that will be loaded on the next read.

Serial Cmd: **<NEWM>**

The imager returns: **<NEWM/next master to load>**

Once a symbol has been read and loaded, the status will be cleared and the response will be **<NEWM/0>**.

(See also [New Master Pin](#) in Chapter 9, [Matchcode](#).)

Delete Master Symbol Data

Definition: You can directly delete the master symbol data by serial command or by **ESP**.

- ESP:*
1. Click the **Utilities** button to access the master symbol.
 2. Click the **Master Database** tab and double-click the symbol number you want to delete.
 3. Delete text and click **OK**.

Serial Cmd: **<K231, master symbol number,>**

To delete a master symbol, enter the database number and a comma, but leave the data field empty. For example, to delete master symbol # 5, send the following: **<K231,5,>**. The command is entered with a blank master symbol data field, which tells the imager to delete the selected master symbol from the database.

Firmware

Firmware by ESP

The screenshot shows a software utility window with two main sections: "Firmware Update" and "Firmware Verification".

- Firmware Update:** Contains a dropdown menu labeled "App Code" and a button labeled "Start...".
- Firmware Verification:** Contains two rows of controls. The first row has a dropdown menu labeled "App Code", a button labeled "Request Part No.", and an empty text input field. The second row has a dropdown menu labeled "App Code", a button labeled "Request Checksum", and an empty text input field.

Firmware Update

Application code versions are specific to your imager. Consult with your sales representative before downloading application code. If needed, an application code will be sent to you in the form of a *.mot file.

To download application code:

1. First, be sure that your imager is connected to the host.
2. Apply power to the imager.
3. Before updating, you should verify the current firmware.
4. Click in the Firmware Update text box and select the file type you want to download. This will open a file locator box.
5. Navigate to the appropriate file (it will be a *.mot file), open the file and click **Start**.

Caution: Do not interrupt power or disconnect the host cable while download is in progress. Be sure that each download is complete before moving on to the next.

Important: When updating firmware, be sure that the application code and boot code versions are mutually compatible.

Firmware Verification

Request Part Number by ESP

You can send a request to the imager for part numbers, checksums, boot code, and application code.

1. Click the **Firmware** tab.
2. From the pulldown selection box to the left of the **Request Part No.** button, make your selection.
3. Select the code type to see its part number displayed in the text field to the right of the **Request Part No.** button.

The screenshot shows a window titled "Firmware Verification" with two rows of controls. The top row consists of a dropdown menu labeled "App Code", a button labeled "Request Part No." (highlighted with a blue border), and a text field containing "35-634001-24". The bottom row consists of a dropdown menu labeled "App Code", a button labeled "Request Checksum", and a text field containing "9070".

Request Part Number by Serial Command

- When you send **<#>** (a request for all product part numbers), the imager returns:
<#b/BOOT_P/N><#a/APP_P/N><#p/PROFILE_P/N>.
- When you send **<#a>** (a request for the application code part number), the imager returns:
<#a/APP_P/N>.
- When you send **<#b>** (a request for the boot code part number), the imager returns:
<#b/BOOT_P/N>.
- When you send **<#p>** (a request for profile module part numbers), the imager returns:
<#p/PROFILE_P/N>.

Request Checksum by ESP

You can send a request to the imager for part numbers, checksums, boot code, and application code.

1. Click the **Firmware** tab.
2. From the pulldown selection box to the left of the **Request Checksum** button, make your selection.
3. Select the code type to see its checksum displayed in the text field to the right of the **Request Checksum** button.

The screenshot shows a window titled "Firmware Verification" with a light beige background. It contains two rows of controls. The top row has a dropdown menu labeled "App Code" on the left, a button labeled "Request Part No." in the middle, and a text input field containing "35-634001-24" on the right. The bottom row has another "App Code" dropdown menu on the left, a button labeled "Request Checksum" in the middle (which is highlighted with a blue border), and a text input field containing "9070" on the right.

Request Checksum by Serial Command

- When you send **<!>** (a request for all available firmware checksums), the imager returns: **<!b/BOOT_CHECKSUM><!a/APP_CHECKSUM><!p/PROFILE_CHECKSUM>**
- When you send **<!a>** (a request for the application code checksum), the imager returns: **<!a/APP_CHECKSUM>**
- When you send **<!b>** (a request for the boot code checksum), the imager returns: **<!b/BOOT_CHECKSUM>**
- When you send **<!p>** (a request for profile module checksum), the imager returns: **<!p/PROFILE_CHECKSUM>**

Default/Reset/Save

Understanding and controlling your imager’s active, saved, and default settings is critical to its successful operation.

	<i>Function</i>	<i>Serial Cmd</i>	<i>ESP (first, right-click in any menu tree)^a</i>	<i>EZ Button</i>
Resets (not saved for power-on)	Reset	<A>	Save to Reader, Send No Save	No
	Reset and Recall Microscan Defaults	<Ard>	No	No
	Reset and Recall Microscan White Balance Defaults	<ArdWB>	No	No
	Reset and Recall Power-On Parameters	<Arp>	No	No
	Reset and Recall Customer Default Parameters	<Arc>	No	No
Saved for Power-on	Save Current Settings for Power-On	<Z>	Save to Reader, Send and Save	No
	Save Current Settings as Customer Default Parameters for Power-On	<Zc>	Save to Reader, Send and Save Customer Defaults for Power-On ^b	No
	Recall Microscan Default Parameters and Save for Power-On	<Zrd>	No	No
	Reset Microscan Default White Balance Parameters and Save for Power-On	<ZrdWB>	No	No
	Recall Customer Default Parameters and Save for Power-On	<Zrc>	No	Press and hold while powering on imager

a. When you right-click in a menu tree and select **Default Current Menu Settings** or **Default All ESP Settings**, it is important to note that only **ESP** settings are defaulted. To save these defaults to the reader itself, you need to follow up with a **Save to Reader, Send and Save** command.

b. Only available in ESP if enabled under the Options pull-down menu.

Resets

Resets (“A” commands) affect only the current settings (active memory) and are not saved for power-on.

Saved for Power-on

Power-on parameters (“Z” commands) are saved to NOVRAM and recalled and loaded into current parameters when power is cycled to the imager or the <Arp> command is issued.

Defaults

Defaults are Microscan firmware settings or saved customer settings that can be recalled, either by software or hardware reset.

Customer Default Parameters

Customer default parameters (saved by **<Zc>**) are the same set of parameters as power-on parameters but are saved in a different, isolated section of NOVRAM. This allows a user essentially to create a backup set of parameters that can be recalled in the event that the current parameters or power-on parameters have been accidentally changed or are no longer desired.

It is important to note that a hardware default does not affect customer default parameters. For example, a user that has inadvertently changed communication settings and saved them with a **<Z>** command, may not know the correct settings or have the capability to communicate within those settings. By first doing an EZ Button default or hardware default to restore the known Microscan defaults, the user can then recall the previous customer-saved settings with an **<Arc>** or **<Zrc>** command.

Microscan Default Parameters

Microscan default parameters are contained in the firmware and cannot be changed.

Software Defaults

Microscan default parameters can be recalled (loaded into current settings) with the **<Ard>** command or recalled and saved for power-on with the **<Zrd>** command.

Hardware Default

If a software default and reset is not possible, it may be necessary to reset the reader by shorting (connecting) specific pins. This procedure has the same effect as the **<Zrd>** software command.

Important: For this reset to occur, this command must be executed within 60 seconds of a power-on or a reset.

1. Apply power to the reader.
2. If using an IB-131, locate pins 7 and 11 on the host connector.
Caution: Be certain that the correct pins are located. Connecting the wrong pins could cause serious damage to the unit.
3. Momentarily connect these wires (or pins) and listen for a series of short beeps.
4. Within 3 seconds, connect them again. A longer beep should be heard. If not, repeat the process.

Default on Power-On

You can also use the EZ Button to default the reader by holding it down while applying power to the reader, provided that this feature is enabled.

Imager Status Requests

<?> Status Byte

The imager responds to a status request <?> with a two character hex value, such as <?/22>. To determine status:

1. Look up the binary conversion in the table below.
For example, the first hex **2** would be **0 0 1 0** in binary, as read from binary digits **3** through **0**; the second hex **2** is also **0 0 1 0** as read from binary digits **7** through **4**.
2. Next, enter your binary values from the table below in the "Binary" column next to the appropriate bit.

Bit	Binary	Imager Status
0	0	Command error detected
1	1	Command received
2	0	Communication error detected
3	0	Flash sector unprotect failure
4	0	Host/Aux port buffer overflow
5	1	Imager is in a read cycle

3. Under "Binary," interpret **1s** as true and **0s** as not true. For example, bit 1 has a **1** in the "Binary" column, indicating "Command Received". Bit 5 is also a **1**, indicating that the "Imager is in a read cycle".

Hex Value	Binary Bit Digits			
	7	6	5	4
	3	2	1	0
0	0	0	0	0
1	0	0	0	1
2	0	0	1	0
3	0	0	1	1
4	0	1	0	0
5	0	1	0	1
6	0	1	1	0
7	0	1	1	1
8	1	0	0	0
9	1	0	0	1
A	1	0	1	0
B	1	0	1	1
C	1	1	0	0
D	1	1	0	1
E	1	1	1	0
F	1	1	1	1

<K?> All Status Request

This is the fastest way to learn the imager's current configuration. Sending this request will return the current settings of all commands, starting with the lowest K command value and ending with the highest K command value.

<K??> All Descriptor Status Request

This request will return all current descriptors for every K command, starting with the lowest K command value and ending with the highest K command value.

<K?#> All Range Status Request

This request will return the current settings of all commands within the user-defined range, starting with the lowest user-defined K command value and ending with the highest user-defined K command value.

<Knnn?> Single Status Request

This request will return the value of the variables associated with the requested K command. The request of a single entry of a database command cannot exceed the number of database slots for the specific command.

<Knnn??> Single Descriptor Status Request

This request returns the basic functional description of all fields in the requested K command.

<Knnn?#> Single Range Status Request

This request will return the value range and storage type description of all fields in the requested K command.

<Knnn?*> Display Command Wildcard

This request will return the individual K command status, description, and range for each parameter.

Other Operational Serial Commands

The following serial utility commands can be entered from ESP's Terminal or a PLC:

Y-Modem Upload Transfer Options

<uy,path,filename>

Y-Modem Download Transfer Options

<dy,path,filename>

Image Library Request

<op,9> Manages files in a selected directory.

<i>File Source</i>	<i>Explanation</i>
(Nothing)	All files in "root" directory
/	All files in "root" directory
/saved	All files in "saved" directory
.	All files in all directories
/del	Deletes all files in the root director
/saved/del	Deletes all files in the saved directory
del*.*	Deletes files in all directories

White Balance Calibration

<@WB>

The Quadrus MINI 3's factory default values are appropriate for nearly all applications. However, the **White Balance** calibration command will override the pre-configured values if necessary.

White Balance is a processing operation performed to ensure proper color fidelity in a captured digital image. The image sensor does not detect light in exactly the same way as the human eye, which means that some processing or correction of the detected image is necessary to ensure that the final image realistically represents the colors of the original image.

White Balance calibration works best if a white object (a piece of paper, for example) is placed in front of the imager. White and black objects can be present in the field of view during White Balance calibration, but no color objects can be present.

Important: The White Balance correction adjusts the **R**, **G**, and **B** gain offset values for every possible analog gain (0 to 42) in the system. Any gain values greater than 42 (43 to 48) will use the factory default White Balance settings.

Bar Code Configuration Mode

Definition: **Bar Code Configuration Mode** is a way of programming the imager by using ECC 200 Data Matrix symbols.

Serial Cmd: <**BCCFG**>

Bar Code Configuration Mode can be entered three different ways:

1. By forcing the imager into **Bar Code Configuration Mode** by serial command <**BCCFG**>.
2. By configuring one of the 4 EZ Button positions to **Bar Code Configuration Mode**.
3. By reading a Data Matrix symbol with a special code word used by ISO/IEC 16022 to signify imager programming. This can be either in a regular read cycle or during a read rate test. Reading this symbol in the calibration routine will have no effect.¹

Once **Bar Code Configuration Mode** has been entered, the Data Matrix symbols can be thought of as serial data. You can configure the imager by printing labels in Microscan's serial command format. Commands are processed as if the data were streamed in through the serial port. The imager will acknowledge the symbol with a beep, green flash, and echo the serial data to the host. If the command causes the imager to produce more serial output, such as serial verification or counter requests, the data will be routed to the host port.

Bar Code Configuration Mode can be exited by any reset <**A**> or <**Z**> command as well as a <**J**> or a quick press and release of the EZ Button.

The command to exit **Bar Code Configuration Mode** can be included as part of the Data Matrix symbol. For example, try encoding <**K200,4**><**K220,1**><**J**> into a Data Matrix symbol. This configures the imager to enable **Serial Trigger Mode**, to program a new trigger to end the read cycle, and to exit **Bar Code Configuration Mode** with <**J**>.

To end all EZ Button functions, press the EZ Button once and quickly release.

1. In normal reading modes, it is required to read a special Data Matrix symbol with a special codeword used by ISO/IEC 16022 to signify imager programming.

14 Output Format

Contents

- Output Format Serial Commands..... 14-2
- Output Format Status 14-3
- Format Assign 14-4
- Format Extract..... 14-5
- Format Insert 14-7
- Output Filter Configuration 14-9
- Ordered Output Filter 14-13

This section explains how to control the formatting and filtering of decoded symbol data for output.

Output Format Serial Commands

Format Extract	< K740 , <i>output index,start location,length</i> >
Format Insert	< K741 , <i>output index,length,hex string</i> >
Format Assign	< K742 , <i>symbol number,status</i> >
Format Status	< K743 , <i>output format status</i> >
Output Filter Configuration	< K744 , <i>filter number,symbology type,length,wildcard,placeholder,data,unused,database index</i> >
Ordered Output Filter	< K745 , <i>number of filters</i> >

Output Format Status

Definition: This is a global enable/disable parameter. In order to use formatting you must set up the format using the insert and extract commands, and you must also assign a symbol to format using the **Format Assign** command.

Serial Cmd: <K743,output format status>

Default: Disabled

Options: 0 = Disabled
1 = Enabled

Output Format Status Disabled

When **Output Format Status** is set to **Disabled**, output formatting is globally disabled.

Output Format Status Enabled

When **Output Format Status** is set to **Enabled**, output formatting is enabled. However, **Format Assign**, **Format Insert**, and **Format Extract** must be properly set up as well.

Output Format Status by ESP



Click this button and then the **Output Format** tab to bring up the Output Format view.

On the **Output Format** tab, check the **Enable Output Format** box.

Ordered Output | Output Format

Enable Output Format Auto Sync with Reader

Set Number of Symbols: 1

Output Phrase

Preamble: Symbol #1  Postamble:

Enable Parse Enable

Parse Symbols... | Send and Save | Receive | Quality Parameters...

▶ Show Parse Table

Format Assign

Symbol Number

Definition: **Symbol Number** refers to the number of the symbol to which output formatting will apply. For example, if you wish to enable user-defined formatting to symbol # 2 in a multisymbol read cycle, you would send the command **<K742,2,1>**. Note that the number of symbols may exceed the format capabilities.

Serial Cmd: **<K742, symbol number, status>**

- Options:** 1 to 10
- 1 = Formatted output status for symbol # 1.
 - 2 = Formatted output status for symbol # 2.
 - ...
 - 10 = Formatted output status for symbol # 10.

Status

Definition: **Status** refers to the user-defined formatting of a selected symbol position in the read cycle result. Note that there is also a global formatting “enable” command that must be set for the formatting to be applied.

Serial Cmd: **<K742, symbol number, status>**

Default: **Disabled**

- Options:** **0 = Disabled**
1 = Enabled (Assign parameters to specified symbol.)

Format Assign by ESP

Enable Output Format

Set Number of Symbols: 5

Use the **Set Number of Symbols** spin box to determine the number of symbols to be included in the output phrase.

Output Phrase

Preamble:	Symbol #1	Symbol Separator:	Symbol #2	Symbol #3	Symbol #4	Symbol #5	Postamble:
CR	[Barcode]	,	[Barcode]	[Barcode]	[Barcode]	[Barcode]	CR LF
<input checked="" type="checkbox"/> Enable	<input checked="" type="checkbox"/> Parse		<input checked="" type="checkbox"/> Parse	<input checked="" type="checkbox"/> Parse	<input type="checkbox"/> Parse	<input type="checkbox"/> Parse	<input checked="" type="checkbox"/> Enable

Then check the **Parse** boxes beneath the symbols that you wish to format for user-defined output.

Format Extract

Output Index

Definition: **Output Index** refers to the database entry you wish to modify with this command. A formatted output is built by *extracting data from a symbol's original data output* and/or inserting user-defined characters.

It may be helpful to think of individual indexes as positions in the final formatted output you wish to build. Starting with index # 1, enter either an extract or insert command to begin building your desired output string. Then, with the next index number, enter either an extract or insert command to continue building the output string. Continue this process until you are finished building the string.

Serial Cmd: <**K740**,*output index*,*start location*,*length*>

Options: 1 to 100

Start Location

Definition: Defines the location within the symbol data where the character extraction will begin. The first character extracted will also be the first character in the sequence displayed in user-defined output.

Serial Cmd: <**K740**,*output index*,**start location**,*length*>

Default: **0**

Options: 1 to *n* (maximum number of characters in the symbol data).

Length

Definition: Defines the length (in consecutive characters) that will be extracted and placed in user-defined output.

Serial Cmd: <**K740**,*output index*,*start location*,**length**>

Default: **0** (disabled; end of format cell array)

Options: 1 to *n* (maximum number of characters in the symbol data).

Format Extract by ESP

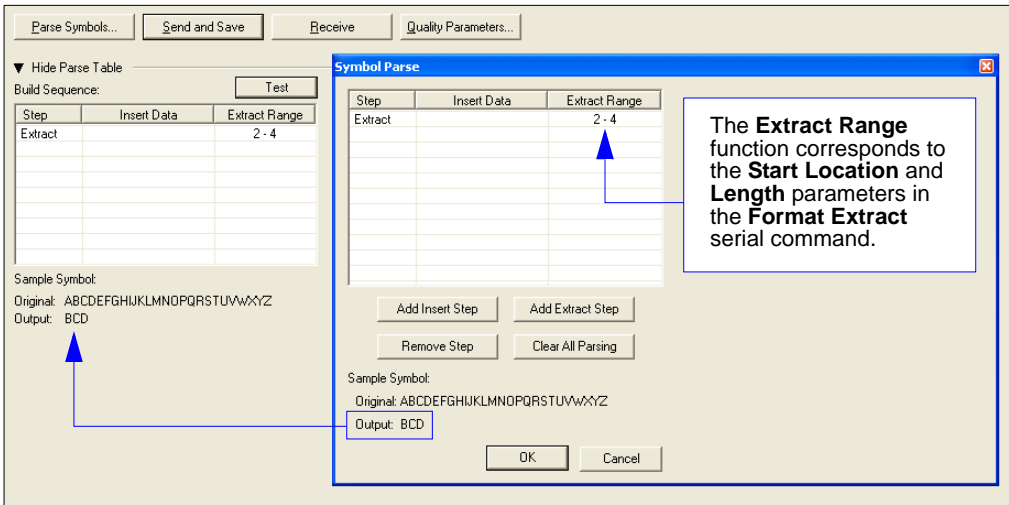

You can extract and insert several character sequences using **ESP's Symbol Parse** feature. In this example, the selected extraction range is characters 2-4. The "Sample Symbol" example on the **Symbol Parse** dialog shows the selected character positions extracted and output as desired. Simultaneously, the data string from the actual selected symbol is displayed at the bottom left of the **Parse Table**, followed by the user-defined extracted output.

Format Insert

Output Index

Definition: **Output Index** refers to the database entry you wish to modify with this command. A formatted output is built by extracting data from a symbol's original data output and/or *inserting user-defined characters*.

It may be helpful to think of individual indexes as positions in the final formatted output you wish to build. Starting with index # 1, enter either an extract or insert command to begin building your desired output string. Then, with the next index number, enter either an extract or insert command to continue building the output string. Continue this process until you are finished building the string.

Serial Cmd: <**K741**, **output index**, *length*, *hex string*>

Options: 1 to 100

Length

Definition: Specifies the length of the user-defined character string that will be inserted. This function is limited to 4 characters per output index, so multiple indexes must be entered in order to insert longer character sequences.

For example, if you wish to insert a 10 character sequence in user-defined output, you would need three commands with consecutive index numbers, where the first two character sequence lengths were 4 and the third was 2.

Serial Cmd: <**K741**, *output index*, **length**, *hex string*>

Default: **0** (disabled; end of format cell array)

Options: 1 to 4

Hex String

Definition: Specifies a character string that represents ASCII characters to be inserted in the database entry. Two hex characters are required for every ASCII character to be inserted in the user-defined output string. These two characters comprise the hex (base 16) value of the ASCII character.

For example, if you wanted to enter the three-character sequence "Hj!" you would enter **3** for the length of the string, and a hex sequence of **486921** for the ASCII sequence to be inserted. (48 = H; 69 = j; 21 = !)

Important: Each pair of hex characters represents one ASCII character. Hex character pairs range from 00 to FF. Since you are limited to 4 ASCII characters per insertion per database entry, you are likewise limited to 8 hex characters per insertion per database entry.

Serial Cmd: <**K741**, *output index*, *length*, **hex string**>

Default: **NUL** (00 in hex)

Options: 00 to FF (As many as 4 bytes, or hex pairs.)

See [ASCII Character Entry Modifier](#) on page 3-32 for a detailed explanation of how to enter ASCII characters as hex values.

Format Insert by ESP

Symbol Parse

Step	Insert Data	Extract Range
Insert		

Add Step Remove Step Clear All Parsing

Sample Symbol Parse:
Original: ABCDEFGHIJKLMNOPQRSTUVWXYZ0123456789
Output:

OK Cancel

Insert

SP SP

SOH	STX	ETX	EOT	ENQ
ACK	BEL	BS	HT	LF
VT	FF	CR	SO	SI
SI	DC1	DC2	DC3	DC4
NAK	SYN	ETB	CAN	EM
SUB	ESC	FS	GS	RS
US	SP			

Click 'Delete' to remove characters.

OK Cancel

The **Format Insert** process is very similar to the **Format Extract** process, except that **Insert** allows you to enter characters using the **Insertion Calculator** (shown above).

Parse Symbols Send and Save

Hide Parse Table

Build Sequence: Test

Step	Insert Data	Extract Range
Insert	SP SP	
Extract		3 - 5

Add Step Remove Step Clear All Parsing

Sample Symbol Parse:
Original: micro
Output: cro

Symbol Parse

Step	Insert Data	Extract Range
Insert	SP SP	
Extract		3 - 5

Add Step Remove Step Clear All Parsing

Sample Symbol Parse:
Original: ABCDEFGHIJKLMNOPQRSTUVWXYZ0123456789
Output: CDE

OK Cancel

Notice that **Extract** and **Insert** share the same **Parse Table**.

Output Filter Configuration

Definition: Output filtering is a method of providing a set of good read qualifiers and also providing ordered output. There is a filter for up to the first 10 positions in a multisymbol output. The first filter corresponds to the first symbol output at the end of the read cycle. Each filter has settings for the following four parameters: **Symbology Type**, **Symbol Length**, **Data**, and **Configuration Database Number**.

Serial Cmd: <**K744**, filter number, symbology type, length, wildcard, placeholder, data, unused, database index>

Rules for Output Filter Configuration

Output Filter Configuration Rule # 1

Each symbol that is decoded must match one of the filters before it can be saved to a read cycle record. There is an exception to this rule, however, when the number of symbols required for a read cycle exceeds the number of active filters. In such a case, unfiltered symbols can be placed into unfiltered output positions.

For example, if the number of symbols required is 6 but there are only 4 active filters, the last 2 positions can be filled by any (unfiltered) qualified symbol.

Output Filter Configuration Rule # 2

The same filter setup can be used multiple times.

For example, filters 1, 2, and 3 can be set up to filter Data Matrix symbols, and the output will occur in the order the symbols are decoded.

Output Filter Configuration Rule # 3

All qualified symbols will be sorted and output in the matching filter position. If a symbol matches filter 3, it will be output as the third symbol. If a filter does not have a matching qualified symbol, a No Read message will be output in place of the symbol (assuming the No Read message is enabled).

For example, if there is not a symbol that meets filter 3's requirements, then a No Read message will be output in the third output position.

Filter Number

Definition: This is the filter index number that represents the position of the symbol in the data output at the end of the read cycle. This index number should be entered along with the following filter settings for the predetermined symbol position.

Serial Cmd: <**K744**, **filter number**, *symbology type, length, wildcard, placeholder, data, unused, database index*>

Options: 1 to 10

Symbology Type

Definition: Specifies the symbology type allowed to occupy this location in multisymbol output.

Note: To filter or order a symbol, the symbol must meet all the requirements of the selected filter index.

Serial Cmd: <**K744**, *filter number,* **symbology type**, *length, wildcard, placeholder, data, unused, database index*>

Default: **0** (any symbology type)

Options:

0 = Any type

1 = Interleaved 2 of 5

2 = Code 39

3 = Code 128

4 = Codabar

5 = UPC

6 = PDF417

7 = EAN 128

8 = Code 93

9 = Pharmacode

10 = GS1 DataBar (RSS)

11 = MicroPDF417

12 = Composite

13 = BC412

14 = Data Matrix

15 = QR Code

16 = Micro QR Code (Only supported when Q-Mode is enabled.)

17 = Aztec Code (Only supported when Q-Mode is enabled.)

18 = Postal Symbologies (Only supported when Q-Mode is enabled.)

Length

Definition: Specifies the length of the decoded symbol allowed to occupy this location in multisymbol output.

Note: To filter or order a symbol, the symbol must meet all requirements of the selected filter index.

Serial Cmd: <**K744**, filter number, symbology type, **length**, wildcard, placeholder, data, unused, database index>

Default: **0**

Options: 0 to 64

Wildcard

Definition: This is the character to be used in the data output field when performing a data filter comparison. The wildcard character represents the end of matching, and allows for variable lengths of symbol output.

Serial Cmd: <**K744**, filter number, symbology type, length, **wildcard**, placeholder, data, unused, database index>

Default: “ * ” = (**2A** in hex)

Options: Any ASCII input in the form of a pair of hex characters.

Example:

2A = *

00 = disabled

See [ASCII Character Entry Modifier](#) on page 3-32 for a detailed explanation of how to enter ASCII characters as hex values.

Placeholder

Definition: The placeholder character requires a character to be present, but does not compare the data value.

Serial Cmd: <**K744**, filter number, symbology type, length, wildcard, **placeholder**, data, unused, database index>

Default: “ ? ” = (**3F** in hex)

Options: Any ASCII input in the form of a pair of hex characters.

Example:

3F = ?

00 = disabled

See [ASCII Character Entry Modifier](#) on page 3-32 for a detailed explanation of how to enter ASCII characters as hex values.

Data

Definition: This is the data string to be used when comparing symbol data for output filtering and ordering. This data string may also contain wildcard and placeholder characters to facilitate matching. Remember that in order to filter or order symbol data, it must meet all the requirements of the selected filter index.

Examples:

- Filter data = "123*". This will match data strings of "123", "123456", and "123ABC", but not "12".
- Filter data = "123*AB?C". This will be interpreted as "123*".
- Filter data = "123?". This will match "1234" and "123A", but not "123", "12345", or "1234C".
- Filter data = "123?A". This will match "1234A" and "123BA", but not "123", "1234C", or "1234ABCD".
- Filter data = "123?A?". This will match "1234AB" and "123BAT", but not "1234A" or "123BATS".
- Filter data = "12??*". This will match "1234", "123456", and "123ABC", but not "12" or "123".
- Filter data = "123?A*". This will match "1234A", "123BA", and "123BATS", but not "1234" or "1234C".

Serial Cmd: <**K744**, filter number, symbology type, length, wildcard, placeholder, **data**, unused, database index>

Default: **NUL** (00 in hex)

Options: Any ASCII input in the form of a pair of hex characters.
Maximum length: 63 bytes defined.

Examples:

41422A = AB*

Data [0] = NUL represents string matching disabled.

See [ASCII Character Entry Modifier](#) on page 3-32 for a detailed explanation of how to enter ASCII characters as hex values.

Database Index

Definition: The index of the database entry that decodes a given symbol must equal this setting for filtering to occur. A setting of **0** allows any database index for this filter entry.

Serial Cmd: <**K744**, filter number, symbology type, length, wildcard, placeholder, **data**, unused, **database index**>

Default: **0** (any index)

Options: 0 to 10

Ordered Output Filter

Definition: **Number of Filters** refers to the number of active output filters. **0** disables all output filters. Any non-zero numeral will enable filtering to be performed using the filter indexes covered by this value.

For example, if the number of filters is **1**, then only filter index # 1 will be applied. If the number of filters is **2**, then only filter index # 1 and filter index # 2 will be applied, etc.

Serial Cmd: <**K745,number of filters**>

Default: **0**

Options: 0 to 10

Appendices

Contents

Appendix A General Specifications A-2
Appendix B Electrical Specifications A-5
Appendix C Serial Configuration Commands A-6
Appendix D Communications Protocol A-13
Appendix E ASCII Table A-22
Appendix F Interface Standards A-23
Appendix G Object Detector A-24
Appendix H Operational Tips A-25
Appendix I USB-to-Serial Virtual COM Port Driver A-26
Appendix J Glossary of Terms A-29

Appendix A — General Specifications

Mechanical

Height: 1" (25.4 mm)
Width: 1.8" (45.7 mm)
Depth: 2.10" (53.3 mm)
Weight: 2 oz. (57 g)

Environmental

Enclosure: IP54, category 2
Operating Temperature: 0° to 50°C (32° to 122°F)
Storage Temperature: -50° to 75° C (-58 to 167°F)
Humidity: up to 90% (non-condensing)

CE Mark

General Immunity for Light Industry:
EN 55024:1998+A1:2001+A2:2003
Radiated and Conducted Emissions of ITE Equipment:
EN 55022:1998+A1:2000+A2:2003
for Class A products

Light Source

Type: High-output LEDs

Light Collection Options

Progressive scan, square pixel; Software adjustable shutter speed, electronic shutter

QXGA: 2048 by 1536 pixels

Connector

Type: 3 ft. cable terminated with High Density 15-pin D-Sub socket connector or USB type A connector

Indicators

LEDs: Read Performance, Power, Read Status

Green Flash: Good Read

Blue Target Pattern: Symbol locator

Beeper: Good Read, match/mismatch, No Read, serial command confirmation, on/off

Discrete I/O

Trigger Input: 5 to 28VDC rated (0.16 mA)

New Master: 5 to 28VDC rated (0.16 mA)

Outputs (1, 2, 3): 5V TTL compatible; can sink 10 mA and source 10mA

Optional I/O: Optoisolated (with IC-332 accessory)

Communication Protocols

Standard Interfaces: RS-232, RS-422, USB

Symbologies

2D Symbologies: Data Matrix (ECC 0-200), Aztec Code, QR Code, Micro QR Code

Stacked Symbologies: PDF417, MicroPDF417, GS1 DataBar (RSS) (Composite and Stacked)

Linear Symbologies: Code 39, Code 128, BC412, Interleaved 2 of 5, Pharmacode, UPC/EAN, Codabar, Code 93, Postal

Read Parameters

Pitch: ±30° **Skew:** ±30° **Tilt:** 360°

Decode Rate: Up to 4 decodes per second

Focal Range: 2 to 6" (50.8 to 152.4 mm) (autofocus)

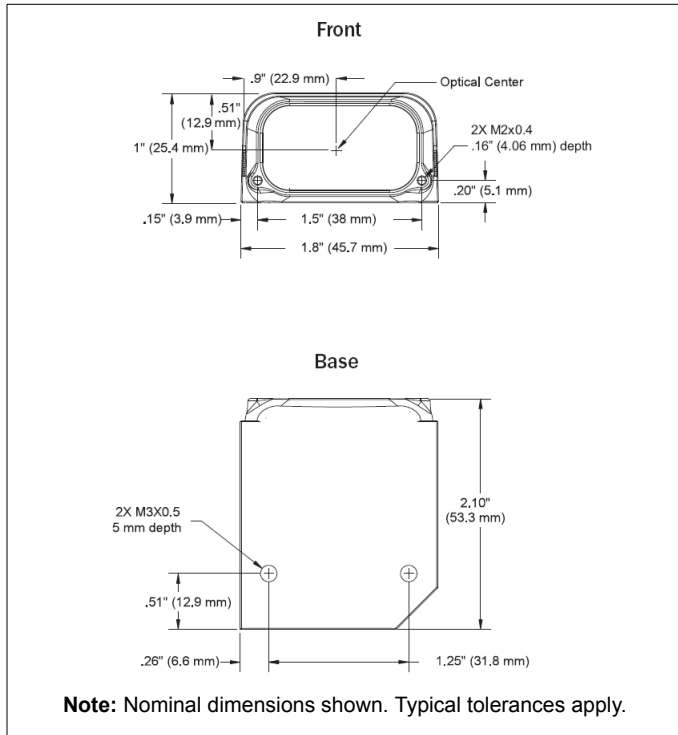

Quadrus MINI 3 Imager Dimensions

Read Ranges

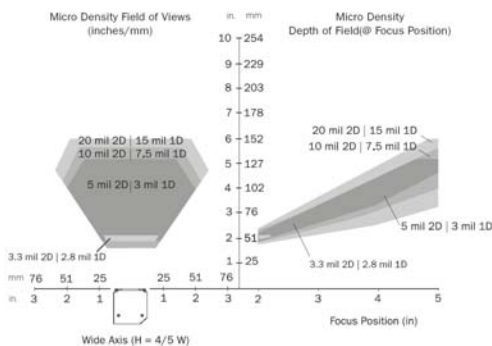

Micro Density

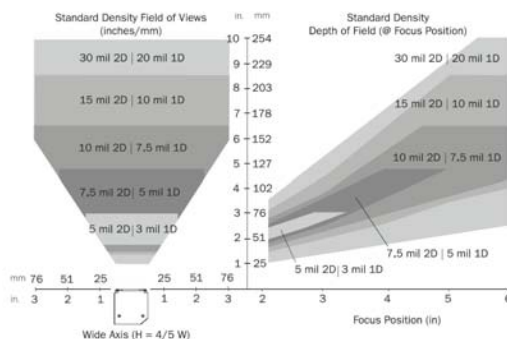

Standard Density

Narrow-bar-width		Field of View (maximum)	Read Range (with autofocus)
1D	2D		
Micro Density			
.0028" (.07 mm)	.0033" (.08 mm)	1.2" (30.5 mm)	1.9 to 2.0" (48.3 mm to 50.8 mm)
.0033" (.08 mm)	.005" (.13 mm)	3.0" (76.2 mm)	1.9 to 5.1" (48.3 mm to 129.5 mm)
.0075" (.19 mm)	.010" (.25 mm)	3.4" (86.4 mm)	1.7 to 5.6" (43.2 mm to 142.2 mm)
.015" (.38 mm)	.020" (.51 mm)	3.6" (91.4 mm)	1.7 to 6.0" (43.2 mm to 152.4 mm)
Standard Density			
.0033" (.08 mm)	.005" (.13 mm)	3.2" (81.3 mm)	1.9 to 3.0" (48 mm to 76.2 mm)
.005" (.13 mm)	.0075" (.19 mm)	5.0" (127 mm)	1.8 to 4.8" (46 mm to 121.9 mm)
.0075" (.19 mm)	.010" (.25 mm)	6.2" (157.5 mm)	1.6 to 6.5" (41 mm to 165.1 mm)
.010" (.25 mm)	.015" (.38 mm)	8.5" (215.9 mm)	1.4 to 8.5" (36 mm to 215.9 mm)
.020" (.51 mm)	.030" (.76 mm)	9.5" (241 mm)	1.0 to 10.0" (25 mm to 254 mm)

General Specifications

FIS Options

Quadrus MINI 3 Imager	
3 Megapixel Imager, Standard Density, RS-232/422/485, 5VDC	FIS-6300-2001G
3 Megapixel Imager, Micro Density, RS-232/422/485, 5VDC	FIS-6300-2002G
3 Megapixel Imager, Standard Density, USB, 5VDC	FIS-6300-2003G
3 Megapixel Imager, Micro Density, USB, 5VDC	FIS-6300-2004G
3 Megapixel Imager, Q-Mode, Standard Density, RS-232/422/485, 5VDC	FIS-6300-2005G
3 Megapixel Imager, Q-Mode, Micro Density, RS-232/422/485, 5VDC	FIS-6300-2006G
3 Megapixel Imager, Q-Mode, Standard Density, USB, 5VDC	FIS-6300-2007G
3 Megapixel Imager, Q-Mode, Micro Density, USB, 5VDC	FIS-6300-2008G

Safety Certifications

FCC, UL/cUL, CE, CB, RoHS/WEEE



ISO Certification

ISO 9001 Certified

Issued by TUV USA Inc., Member of TUV NORD Group



©2010 Microscan Systems, Inc.

All rights reserved. Specifications subject to change.

Product specifications are given for typical performance at 25°C (77°F) using grade A labels. Performance characteristics may vary at high temperatures or other environmental extremes. Warranty—One year limited warranty on parts and labor. Extended warranty available.

Appendix B — Electrical Specifications

Power: 3.5 Watts (max.)

5VDC +/- 5%, 200 mV p-p max. ripple, 440 mA @ 5VDC (typ.)

Optional Int: 10-28V Accy

Host Connector / Pin Assignments

High Density 15 Pin D-sub Socket Connector

Pin	Host RS-232	Host/Aux RS-232	Host RS-422/485	In/Out
1	Power +5 VDC			In
2	TxD	TxD	TxD(-)	Out
3	RxD	RxD	RxD(-)	In
4	Power/Signal Ground			
5	NC			
6	RTS	Aux TxD	TxD(+)	Out
7	Output 1 TTL a			Out
8	Default configuration b			In
9	Trigger			In
10	CTS	Aux RxD	RxD(+)	In
11	Output 3 TTL a			Out
12	New Master (NPN)			In
13	Chassis ground c			
14	Output 2 TTL a			Out
15	NC			

a. Can sink 10 mA and source 10 mA.

b. The default is activated by connecting pin 8 to ground pin 4.

c. Chassis ground: Used to connect chassis body to earth ground only. Not to be used as power or signal return.

Appendix C — Serial Configuration Commands

Note: For a list of utility commands such as read rate requests, device control options, and imager status requests, see [Serial Utility Commands](#) on page 13-2.

Communications

Host Port Connections	<K100,baud rate,parity,stop bits,data bits>
Auxiliary Port Connections	<K101,aux port mode,baud rate,parity,stop bits,data bits,daisy chain ID status,daisy chain ID>
RS-422 Status	<K102,status>
Host Port Protocol	<K140,protocol,address>
Preamble	<K141,status,preamble characters>
Postamble	<K142,status,postamble characters>
Response Timeout	<K143,response timeout>
LRC	<K145,status>
Auxiliary Port System Data Status	<K146,aux>
ACK/NAK Options	<K147,RES,REQ,STX,ETX,ACK,NAK>
Polling Mode Options	<K148,RES,REQ,STX,ETX,ACK,NAK>
Autoconfiguration Daisy Chain	<K150DAISY>

Calibration

Calibration Options	<K529,gain,shutter speed,focus position,symbol type,WOI framing,WOI margin,line scan height>
Calibrate	<@CAL>

Read Cycle

Trigger Mode/Filter Duration	<K200,trigger mode,leading edge trigger filter,trailing edge trigger filter>
Serial Trigger Character	<K201,serial trigger character>
External Trigger State	<K202,external trigger state>
End of Read Cycle	<K220,end of read cycle,read cycle timeout>
Minimum Good Reads	<K221,minimum good reads>
Multisymbol	<K222,number of symbols,multisymbol separator>
Start Trigger Character	<K229,start character>
Stop Trigger Character	<K230,stop character>
Capture Mode	<K241,capture mode,number of captures,rapid capture mode,pre-processing>
Capture Timing	<K242,time before first capture,time between first and second captures,,,,,,time between seventh and eighth captures>
Image Storage	<K244,image storage type,image store mode>
IP Timeout	<K245,image processing timeout>

Symbologies

Narrow Margins/Symbology ID	<K450,narrow margin status,symbology identifier status>
Background Color	<K451,background color>
Composite	<K453,symbology status,separator status,separator>
Aztec Code	<K458,status>

Micro QR Code	<K459,status>
Postal Symbolologies	<K460,postal symbology type,POSTNET status,PLANET status,USPS4CB status,POSTNET allow B and B' fields,Australia Post allow 0 FCC>
Code 39	<K470,status,check character status,check character output status,large intercharacter gap,fixed symbol length status,fixed symbol length,full ASCII set>
Codabar	<K471,status,start/stop match,start/stop output,large intercharacter gap,fixed symbol length status,symbol length,check character type,check character output>
Interleaved 2 of 5	<K472,status,check character status,check character output status,symbol length #1, symbol length #2, guard bar status,range mode status>
UPC/EAN	<K473,UPC status,EAN status,supplemental status,separator status,separator character,supplemental type,format UPC-E as UPC-A>
Code 128/EAN 128	<K474,status,fixed symbol length status,fixed symbol length,EAN 128 status,output format,application record separator status,application record separator character,application record brackets,application record padding>
Code 93	<K475,status,fixed symbol length status,symbol length>
PDF417	<K476,status,[unused],fixed symbol length status,fixed symbol length,[unused],codeword collection>
Pharmacode	<K477,status,fixed bar count status,fixed bar count,minimum bar count,bar width mode,direction,fixed threshold value>
Data Matrix	<K479,ECC 200 status, ECC 000 status,ECC 050 status, ECC 080 status,ECC 100 status,ECC 140 status,ECC 120 status,ECC 130 status>
QR Code	<K480,status>
BC412	<K481,status,check character output,fixed symbol length status, fixed symbol length>
DataBar-14 (RSS-14)	<K482,status>
DataBar Limited (RSS Limited)	<K483,status>
DataBar Expanded (RSS Expanded)	<K484,status,fixed symbol length status,fixed symbol length>
MicroPDF417	<K485,status,[unused],fixed symbol length status,fixed symbol length>

I/O Parameters

Power On/Reset Counts	<K406,power-on,resets,power-on saves,power-on flash saves>
Time Since Reset	<K407,hours,minutes>
Service Message	<K409,status,service message,threshold,resolution>
Serial Verification	<K701,serial command echo status,serial command beep status, control/hex output>
Beeper	<K702,status>
Quality Output	<K704,quality output separator,decodes/trigger status>
Symbol Data Output	<K705,symbol data output status,when to output>
Read Duration Output	<K706,status,separator>
No Read Message	<K714,status,message>
Bad Symbol Message	<K715,[unused],message>
No Symbol Message	<K716,[unused],message>

Serial Configuration Commands

1D/Stacked Symbology Qualification	< K717 ,minimum number of bars,minimum number of qualified scan lines,start/stop status>
2D Symbology Qualification	< K718 ,finder pattern status,symbol size status,symbol size 1,symbol size 2,symbol size tolerance,dimension status,dimension 1,dimension 2,dimension tolerance,orientation status,orientation value>
Frame Information	< K734 ,output frame number,output coordinates>
LED Configuration	< K737 ,LED mode,ISO/IEC 16022 grade>
Image Output	< K739 ,image output mode,communication port,file format,JPEG quality>
Target/Flood LEDs	< K750 ,green flash LED status,target pattern LED status,green flash duration>
EZ Trax Output	< K757 ,comm port,image mode,image format,JPEG quality,object info output,grade output>
Database Identifier Output	< K759 ,status,separator>
EZ Button	< K770 ,global status,default on power-on,load configuration database,save for power-on>
EZ Button Modes	< K771 ,single beep,two beeps,three beeps,four beeps>
Trend Analysis Output 1	< K780 ,trend analysis mode,trigger evaluation period,number to output on>
Trend Analysis Output 2	< K781 ,trend analysis mode,trigger evaluation period,number to output on>
Trend Analysis Output 3	< K782 ,trend analysis mode,trigger evaluation period,number to output on>
Diagnostic Output 1	< K790 ,unused 1,service unit>
Diagnostic Output 2	< K791 ,unused 1,service unit>
Diagnostic Output 3	< K792 ,unused 1,service unit>
ISO/IEC 16022 Symbol Quality Output 1	< K800 ,output on symbol contrast,symbol contrast threshold,output on print growth,print growth threshold,output on axial non-uniformity,axial non-uniformity threshold,output on UEC,UEC threshold>
ISO/IEC 16022 Symbol Quality Output 2	< K801 ,output on symbol contrast,symbol contrast threshold,output on print growth,print growth threshold,output on axial non-uniformity,axial non-uniformity threshold,output on UEC,UEC threshold>
ISO/IEC 16022 Symbol Quality Output 3	< K802 ,output on symbol contrast,symbol contrast threshold,output on print growth,print growth threshold,output on axial non-uniformity,axial non-uniformity threshold,output on UEC,UEC threshold>
Configurable Output 1	< K810 ,output on,output state,pulse width,output mode>
Configurable Output 2	< K811 ,output on,output state,pulse width,output mode>
Configurable Output 3	< K812 ,output on,output state,pulse width,output mode>
Symbol Quality	
Symbol Quality Separator/ Data Matrix Output Mode	< K708 ,symbol quality separator,data matrix output mode>
ISO/IEC 16022 Symbol Quality Output	< K709 ,symbol contrast,print growth,axial non-uniformity,UEC>
Microscan Symbol Quality Output	< K710 ,percent cell damage,total read time,capture time,locate time,decode time,pixels per element,ECC level,matrix size,quiet zone>
Static Validation Report	< VAL >

Matchcode

Matchcode Type	<K223,matchcode type,sequential matching,match start position,match length,wild card character,sequence on No Read,sequence on mismatch>
Number of Master Symbols	<K224,number of master symbols>
New Master Pin	<K225,status>
Enter Master Symbol Data	<K231,master symbol number,master symbol data>
Request Master Symbol Data	<K231?,>[for all] or <K231?,master symbol number>
Delete Master Symbol Data	<K231,master symbol number,>
Match Replace	<K735,status,match replacement string>
Mismatch Replace	<K736,status,mismatch replacement string>

Camera and IP Setup

IP Threshold	<K512,threshold mode,fixed threshold value,cycle min,cycle max,cycle step,adaptive contrast percent>
Mirrored Image	<K514,mirrored image>
Window of Interest	<K516,row pointer,column pointer,row depth,column width>
Hollow Mode	<K517,hollow mode status>
Number of Symbols in Field of View	<K518,number of symbols in field of view>
Damaged Symbol	<K519,damaged symbol status>
Focal Distance	<K525,focal distance>
Increment Focus Position	<525+>
Decrement Focus Position	<525->
Focal Distance Table (Read-Only)	<K526,number of focal distances,focal distance>
IP Mode	<K527,IP Mode,FLM direction>
Illumination Brightness	<K536,brightness>
Camera	<K541,shutter speed,gain>
Pixel Sub-Sampling	<K542,sub-sampling>

Configuration Database

Number of Active Indexes	<K252,number of active database settings,database sort>
Configuration Database Status	<K255,index,shutter speed,gain,focal distance,digital zoom,row pointer,column pointer,row depth, column width,threshold mode,fixed threshold value,processing mode, narrow margins, background color,symbology>
Save Current Settings to Database	<K255+,index>
Load Current Settings from Database	<K255-,index>
Request Selected Index Settings	<K255?,index>
Request All Database Settings	<K255?>
Database Mode	<K256,switch mode,frame count/time,image process looping,image dimensions>

Output Format

Format Extract	<K740,output index,start location,length>
Format Insert	<K741,output index,length,hex string>
Format Assign	<K742,symbol number,status>

Communication Protocol Commands

Format Status	<K743,output format status>
Output Filter Configuration	<K744,filter number,symbology type,length,wildcard,placeholder,data,unused,database index>
Ordered Output Filter	<K745,number of filters>

Serial Command Format

Serial commands are of two types: utility and configuration.

Rules that apply to both utility and configuration commands

- A less than < and greater than > character enclose the commands.
- Commands and data are “case sensitive.” That is, characters must be entered as upper or lower case, as specified.

Serial Utility Commands

These are sent during operations and are not followed by <A> or <Z>.

Serial Configuration “K” Commands

These begin with a single “K” character followed by a 3-digit numeric character, data fields, and an initializing command, as follows:

<Knumeric parameter,data,data,...etc.><initializing command>

An initializing command <A> or <Z> may follow the command. A <Z> initializes the imager’s memory and saves for power-on; an <A> initializes the imager’s memory but does not save for power-on.

For example, to enable **UPC** and save the change for power-on, send <K473,1><Z>.

To change **Baud Rate** and reset without saving changes for power-on, send <K100,3><A>.

Serial Configuration Command Conventions

- All data fields (except the last) must be followed by a comma (*without a space*).
- NUL cannot be used. The characters <, >, and , can be used, but only if entered as hex pairs (see [ASCII Character Entry Modifier](#) on page 3-32).
- All fields preceding a modified field must be included.
- If there is no change in preceding fields, then commas alone can be entered in these fields. For example, if only the last field in the following command is changing, <K100,4,1,0,0> can be entered as <K100,,,,0>.
- All fields *following* a modified field can be omitted. For example, to change **Baud Rate** only, send <K100,3>.

Concatenating Configuration Commands

Commands can be concatenated (added together) in a single string or data block. For example, **<K145,1><K220,1><K450,1><A>** enables **LRC**, sets **End of Read Cycle** mode to **New Trigger**, enables **Narrow Margins**, and resets the data buffers (without saving the changes for power-on).

Serial Command Status Request

To ensure that any command was received and accepted, you can send the **Show Reader Status** command: **<?>**.

The status of a specific serial command can be requested by entering the command followed by a question mark. For example, send **<K142?>** to request the status of **Postamble**.

Entering Control Characters in Serial Commands

To enter control characters within a serial command, hold down the **Ctrl** key while typing the desired character.

Example: To enter a carriage return and line feed (**^M^J**), enter **<K141,1,CNTL-m CNTL-j>**

Appendix D — Communications Protocol

Communications Protocol Command Table

Protocol Command (Mnemonic displayed on menu)	Control Characters (Entered in menu or serial command)	Hex Value	Effect of Command
RES	^D	04	Reset
REQ	^E	05	Request
EOT	^D	04	Reset
STX	^B	02	Start of Text
ETX	^C	03	End of Text
ACK	^F	06	Acknowledge
NAK	^U	15	Negative Acknowledge
XON	^Q	11	Begin Transmission
XOFF	^S	13	Stop Transmission

ACK/NAK Data Flow Examples

Setup 1

RES	0x00 (disabled)
REQ	0x00 (disabled)
STX	0x00 (disabled)
ETX	0x00 (disabled)
ACK	0x06
NAK	0x15
LRC	disabled

Transfer 1

HOST_TX	<K141,0>
IMAGER_TX	'ACK'

Transfer 2

HOST_TX	<K141?>
IMAGER_TX	'ACK'
IMAGER_TX	<K141,0>
HOST_TX	'ACK'

Error Condition

Transfer 1

IMAGER_TX	symbol data
HOST_TX	'NAK' (host rejects)
IMAGER_TX	symbol data (resend data)
HOST_TX	'ACK' (transaction complete)

Transfer 2

HOST_TX	<K141?>
IMAGER_TX	'ACK'
IMAGER_TX	<K141,0>
	timeout reached...
	timeout reached...
	timeout reached...
Timeout Reached	transaction aborted, data is flushed

Setup 2

RES	0x00 (disabled)
REQ	0x00 (disabled)
STX	0x00 (disabled)
ETX	0x00 (disabled)
ACK	0x06
NAK	0x15
LRC	enabled

Transfer 1

HOST_TX	<K141,0>a
IMAGER_TX	'ACK'

Transfer 2

HOST_TX	<K141?>B
IMAGER_TX	'ACK'
IMAGER_TX	<K141,0>a
HOST_TX	'ACK'

Error Condition

Transfer 1

HOST_TX	<k141,0>x (BAD LRC)
IMAGER_TX	'NAK'
HOST_TX	<K141,0>a (GOOD LRC)
IMAGER_TX	'ACK'

Setup 3

RES	0x00 (disabled)
REQ	0x00 (disabled)
STX	0x28 '('
ETX	0x29 ')'
ACK	0x06
NAK	0x15
LRC	enabled

Transfer 1

HOST_TX	(<K141,0>)H
IMAGER_TX	'ACK'

Transfer 2

HOST_TX	(<K141?>)k
IMAGER_TX	'ACK'
IMAGER_TX	(<K141,^M>)w
HOST_TX	'ACK'

Setup 4

RES 0x21 '!'
REQ 0x3D '='
STX 0x28 '('
ETX 0x29 ')'
ACK 0x06
NAK 0x15
LRC enabled

Transfer 1

HOST_TX (<K141,0>)H
 IMAGER_TX 'ACK'

Transfer 2

HOST_TX (<K100?>)n
 IMAGER_TX 'ACK'
 HOST_TX '!'
 IMAGER_TX (<K100,8,0,0,1>)X
 HOST_TX 'ACK'
 IMAGER_TX '!'

Error Condition

Transfer 1

HOST_TX (<K141,0>)H
 IMAGER_TX 'ACK'
 HOST_TX (<K100?>)n
 IMAGER_TX 'ACK'
 HOST_TX '!'
 IMAGER_TX (<K100,8,0,0,1>)X
 timeout reached...
 IMAGER_TX '='
 timeout reached...
 IMAGER_TX '='
 timeout reached...
 IMAGER_TX '='
 timeout reached...
 IMAGER_TX '!'

Polling Mode Data Flow Examples

Setup 1

Address	0x01 (translates to) Poll Req @ '0x1C', Unit Select @ '0x1D'
RES	0x04
REQ	0x05
STX	0x02
ETX	0x03
ACK	0x06
NAK	0x15
LRC	disabled

Transfer 1

HOST_TX	'RES' '0x1D' 'REQ' (Select Unit 1 to receive data)
IMAGER_TX	'0x1D' 'ACK' (Unit responds with its address)
HOST_TX	'STX' <T> 'ETX'
IMAGER_TX	'0x1D' 'ACK' (Unit responds with its address)
HOST_TX	'RES' (Terminate Transfer 2)

Transfer 2

HOST_TX	'RES' '0x1C' 'REQ' (Poll Unit 1 for data)
IMAGER_TX	'0x1C' 'STX' <T/00000> 'ETX'
HOST_TX	'ACK'
IMAGER_TX	'RES' (Terminate Transfer 1)

Starting with a 'RES' ensures a clean transaction, without "leftovers" from the previous transaction.

Error Condition 1

HOST_TX	'RES' '0x1C' 'REQ' (Poll Unit 1 for data)
IMAGER_TX	'0x1C' 'STX' <T/00000> 'ETX'
HOST_TX	'Nothing' (Host should 'ACK' here)
	timeout reached...
IMAGER_TX	'REQ' (Unit requests an 'ACK' again)
	timeout reached...
IMAGER_TX	'REQ' (Unit requests an 'ACK' again)
	timeout reached...
IMAGER_TX	'REQ' (Unit requests an 'ACK' again)
	timeout reached...
IMAGER_TX	'RES' (Terminate Transfer 1, data is flushed)

Error Condition 2

HOST_TX 'RES' '0x1C' 'REQ' (Poll Unit 1 for data)
IMAGER_TX '0x1C' 'STX' <T/00000> 'ETX'
HOST_TX '*Nothing*' (Host should 'ACK' here)
 timeout reached...
IMAGER_TX 'REQ' (Unit requests an 'ACK' again)
HOST_TX '*NAK*' (Host rejects data frame)
 (Retry Event)
IMAGER_TX '0x1C' 'STX' <T/00000> 'ETX' (Unit sends again)
HOST_TX 'ACK' (Host receives data)
IMAGER_TX 'RES' (Terminate Transfer 1)

The protocol makes 3 retry attempts before data is flushed and transfer is aborted.

Setup 2

Address	0x01 (translates to) Poll Req @ '0x1C', Unit Select @ '0x1D'
RES	0x04
REQ	0x05
STX	0x02
ETX	0x03
ACK	0x06
NAK	0x15
LRC	enabled

Transfer 1

HOST_TX	'RES' '0x1D' 'REQ' (Select Unit 1 to receive data)
IMAGER_TX	'0x1D' 'ACK' (Unit responds with its address)
HOST_TX	'STX' <T> 'ETX' 'LRC'
IMAGER_TX	'0x1D' 'ACK' (Unit responds with its address)
HOST_TX	'RES' (Terminate Transfer 2)

Transfer 2

HOST_TX	'RES' '0x1C' 'REQ' (Poll Unit 1 for data)
IMAGER_TX	'0x1C' 'STX' <T/00000> 'ETX' 'LRC'
IMAGER_TX	'ACK'
HOST_TX	'RES' (Terminate Transfer 1)

Starting with a 'RES' ensures a clean transaction, without "leftovers" from the previous transaction.

Error Condition 1

HOST_TX	'RES' '0x1C' 'REQ' (Poll Unit 1 for data)
IMAGER_TX	'0x1C' 'STX' <T/00000> 'ETX' 'LRC'
HOST_TX	'Nothing' (Host should 'ACK' here)
	timeout reached...
IMAGER_TX	'REQ' (Unit requests an 'ACK' again)
	timeout reached...
IMAGER_TX	'REQ' (Unit requests an 'ACK' again)
	timeout reached...
IMAGER_TX	'REQ' (Unit requests an 'ACK' again)
	timeout reached...
IMAGER_TX	'RES' (Terminate Transfer 1, data is flushed)

Error Condition 2

HOST_TX ‘RES’ ‘0x1C’ ‘REQ’ (Poll Unit 1 for data)
 IMAGER_TX ‘0x1C’ ‘STX’ <T/00000> ‘ETX’ ‘LRC’
 HOST_TX ‘*Nothing*’ (Host should ‘ACK’ here)
 timeout reached...
 IMAGER_TX ‘REQ’ (Unit requests an ‘ACK’ again)
 HOST_TX ‘NAK’ (Host rejects data frame)
 (Retry Event)
 IMAGER_TX ‘0x1C’ ‘STX’ <T/00000> ‘ETX’ ‘LRC’ (Unit sends again)
 HOST_TX ‘ACK’ (Host receives data)
 IMAGER_TX ‘RES’ (Terminate Transfer 1)

Error Condition 3

HOST_TX ‘RES’ ‘0x1C’ ‘REQ’ (Poll Unit 1 for data)
 IMAGER_TX ‘0x1C’ ‘STX’ <T/00000> ‘ETX’ ‘BAD LRC’
 HOST_TX ‘NAK’ (Host rejects bad LRC data)
 (Retry Event)
 IMAGER_TX ‘0x1C’ ‘STX’ <T/00000> ‘ETX’ ‘GOOD LRC’ (Unit sends again)
 HOST_TX ‘ACK’ (Host receives data)
 IMAGER_TX ‘RES’ Terminate Transfer 1)

The protocol makes 3 retry attempts before data is flushed and transfer is aborted.

Appendix E — ASCII Table

Dec	Hex	Mne	Ctrl	Dec	Hex	Ch	Dec	Hex	Ch	Dec	Hex	Ch
00	00	NUL	^@	32	20	SP	64	40	@	96	60	`
01	01	SOH	^A	33	21	!	65	41	A	97	61	a
02	02	STX	^B	34	22	"	66	42	B	98	62	b
03	03	ETX	^C	35	23	#	67	43	C	99	63	c
04	04	EOT	^D	36	24	\$	68	44	D	100	64	d
05	05	ENQ	^E	37	25	%	69	45	E	101	65	e
06	06	ACK	^F	38	26	&	70	46	F	102	66	f
07	07	BEL	^G	39	27	'	71	47	G	103	67	g
08	08	BS	^H	40	28	(72	48	H	104	68	h
09	09	HT	^I	41	29)	73	49	I	105	69	i
10	0A	LF	^J	42	2A	*	74	4A	J	106	6A	j
11	0B	VT	^K	43	2B	+	75	4B	K	107	6B	k
12	0C	FF	^L	44	2C	,	76	4C	L	108	6C	l
13	0D	CR	^M	45	2D	-	77	4D	M	109	6D	m
14	0E	SO	^N	46	2E	.	78	4E	N	110	6E	n
15	0F	SI	^O	47	2F	/	79	4F	O	111	6F	o
16	10	DLE	^P	48	30	0	80	50	P	112	70	p
17	11	DC1	^Q	49	31	1	81	51	Q	113	71	q
18	12	DC2	^R	50	32	2	82	52	R	114	72	r
19	13	DC3	^S	51	33	3	83	53	S	115	73	s
20	14	DC4	^T	52	34	4	84	54	T	116	74	t
21	15	NAK	^U	53	35	5	85	55	U	117	75	u
22	16	SYN	^V	54	36	6	86	56	V	118	76	v
23	17	ETB	^W	55	37	7	87	57	W	119	77	w
24	18	CAN	^X	56	38	8	88	58	X	120	78	x
25	19	EM	^Y	57	39	9	89	59	Y	121	79	y
26	1A	SUB	^Z	58	3A	:	90	5A	Z	122	7A	z
27	1B	ESC	^[59	3B	;	91	5B	[123	7B	{
28	1C	FS	^\	60	3C	<	92	5C	\	124	7C	
29	1D	GS	^]	61	3D	=	93	5D]	125	7D	}
30	1E	RS	^^	62	3E	>	94	5E	^	126	7E	~
31	1F	US	^_	63	3F	?	95	5F	_	127	7F	D

Appendix F — Interface Standards

Interface Standards, established by the Electronic Industries Association (EIA), specify such things as the signaling voltage levels, maximum cable lengths, and number of drivers. In the Quadrus MINI 3, selection of interface is made by pin assignment and, in the case of host communications, by software switching between RS-232 and RS-422/RS-485.

RS-232

RS-232 defines an interface between two devices such as, for example, the reader and host. It differs from the other interfaces by dedicating individual pins to specific functions and by requiring both devices to share a common ground line. Since both device chassis are connected to a common ground, a ground loop potential and the possibility of noise interference exists. Therefore cable lengths are limited to a maximum of 50 feet (19.7m). Despite being the most limited, this interface is used frequently because of the large installed base of RS-232 equipment.

RS-422/RS-485

RS-422, unlike RS-232, measures signals differentially; that is, the receiver looks at the potentials between the two receive (or transmit) wires rather than the potential between signal and ground. As a result, cables, if shielded, can be up to 4000 feet (1219m) in length. Like RS-232, RS-422 communication is designed for only two devices on a single line and must have a common ground. It can be used wherever RS-232 is used.

USB

The Universal Serial Bus can connect up to 127 devices to a host at a maximum of 6 megabytes per second (Mbps) of bandwidth.

Appendix G — Object Detector

In a typical operation, an imager will wait for symbol data only during a triggered read cycle. A read cycle is initiated by a “trigger” and can be in the form of a serial command from the host (internal trigger) or a signal from an object detector (external trigger).

When an object detector (also called a sensor, package detector, etc.) is used, it is set up so that its beam will bounce off the approaching object and the resulting pulse will be sent to the imager to begin the read cycle. Typically, a detector is positioned so that it will detect the presence of an object before its symbol can be read.

An object detector is mounted in almost any position relative to the object as long as the object passes within range of the detector and direct or reflected light from the detector does not interfere with the imager’s reception.

As the item continues to move down the line, its symbol moves into the imager beam and is decoded.

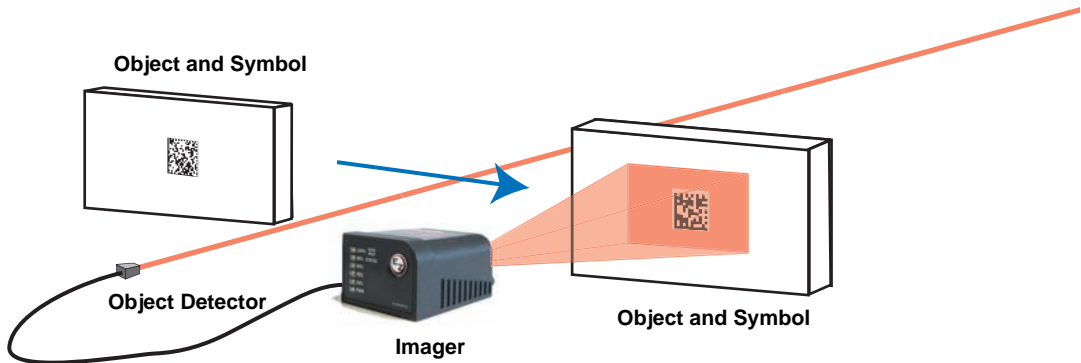

Appendix H — Operational Tips

Cleaning

The Quadrus MINI 3 Imager has a hard-coated window that should only be cleaned with alcohol (100% isopropyl).

Mounting

When mounting the Quadrus MINI 3 Imager, do not insulate the stand mount. The bottom panel is the hottest part of the imager and metal-to-metal contact is necessary for heat dissipation.

Appendix I — USB-to-Serial Virtual COM Port Driver

(For use with Windows® Vista (32-bit), XP (32-bit), and 2000 Operating Systems)

Microscan's USB-to-Serial Virtual COM Port Driver allows you to send serial data using a USB Quadrus MINI 3 Imager. The driver is available at www.microscan.com or on the Microscan Tools CD.

Installing the USB-to-Serial Virtual COM Port Driver

1. Download the driver files from the Microscan website or Microscan Tools CD.
If the driver files are in a .zip file, extract them to a folder of your choice before running the installer.
2. Double-click on **DPInst.exe** to launch the Microscan USB-to-Serial Virtual COM Port Driver Installer.

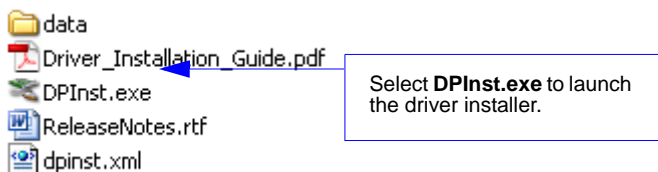

3. Click **Next** on the driver installer's welcome screen.



4. Read the **License Agreement** shown below. If you accept the terms of the agreement, click the radio button next to the statement “I accept this agreement”, and click **Next**.



Important: After accepting the license agreement and clicking **Next**, you may see a Windows Security warning that states “Windows can’t verify the publisher of this driver software”. If you receive this warning, choose the “Install this driver software anyway” option.

5. The driver files will begin installing. This may take several seconds. Do not interfere with the installer during this process.

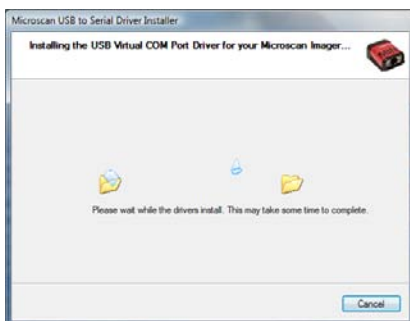

6. Once the driver is installed successfully, you will receive the message shown below. Click **Finish**.



Uninstalling the USB-to-Serial Virtual COM Port Driver

Important: You must uninstall the USB-to-Serial Virtual COM Port Driver any time you require high-speed USB connectivity (to upload images using **EZ Trax**, for example).

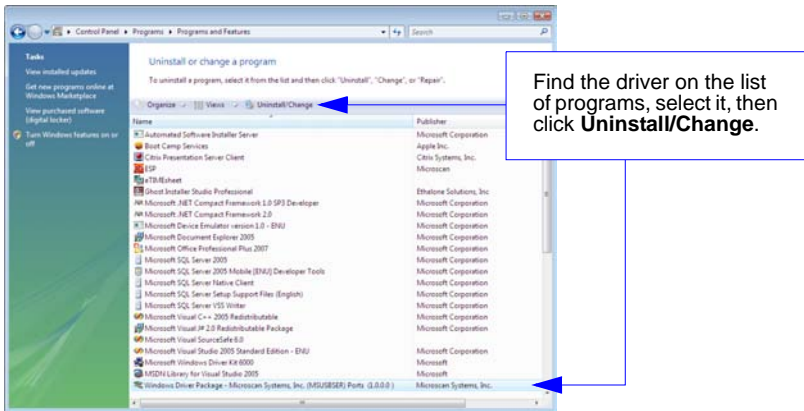

To use the Virtual COM Port again, follow the steps above to re-install the driver.

Changing the COM Port

Follow these steps to change the reader's COM Port:

1. Right-click on **My Computer** in the Windows **Start** menu and select **Properties**.
 2. Select the **Hardware** tab in the **System Properties** dialog and click the **Device Manager** button.
-
3. Expand the **Ports (COM & LPT)** item on the **Device Manager** menu. Right-click on **Microscan Reader** and select **Properties**.
 4. Select the **Port Settings** tab in the **Properties** dialog and click the **Advanced** button.
 5. Expand the **COM Port Number** menu on the **Advanced Settings** dialog and select your new COM Port number.

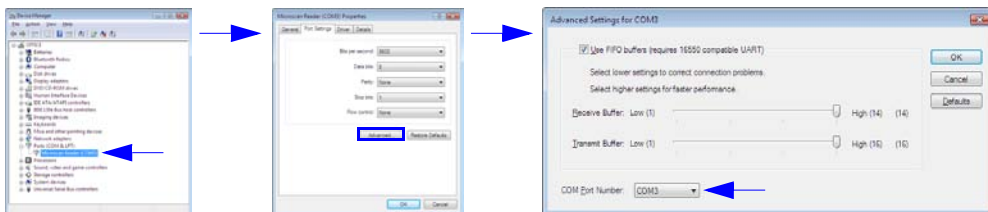

You are now ready to begin using the new COM Port.

Appendix J — Glossary of Terms

Aberration — The failure of an optical lens to produce an exact point-to-point correspondence between the object and its resulting image. Various types are chromatic, spherical, coma, astigmatism and distortion.

Absorption — The loss of light of certain wavelengths as it passes through a material and is converted to heat or other forms of energy. (–)

Active Illumination — Lighting an area with a light source coordinated with the acquisition of an image. Strobed flash tubes and pulsed lasers are examples.

ADC — See **Analog-to-Digital Converter**.

A/D Converter — See **Analog-to-Digital Converter**.

AGC — See **Automatic Gain Control**.

Ambient Light — Light which is present in the environment of the imaging front end of a vision system and generated from outside sources. This light, unless used for actual illumination, will be treated as background **Noise** by the vision system.

Analog — A smooth, continuous voltage or current signal or function whose magnitude (value) is the information.

Analog-to-Digital Converter (A/D Converter or ADC) — A device that converts an analog voltage or current signal to a discrete series of digitally encoded numbers (signal) for computer processing.

Application-Specific Integrated Circuit (ASIC) — An integrated circuit that is customized for a particular kind of use, rather than general use. All vision system elements including firmware can be integrated into one ASIC.

Architecture — The hardware organization of a vision system designed for high speed image analysis.

ASIC — See **Application-Specific Integrated Circuit**.

Aspect Ratio — The ratio between the height and width of a sensor or display. Found by dividing the vertical number of pixels (height) by the horizontal number of pixels (width) leaving it in fractional format.

Automatic Gain Control (AGC) — Adjustment to signal strength that seeks to maintain a constant level regardless of the distance between a reader and symbol.

Auxiliary Port — RS-232 connection to an auxiliary terminal or device for remote viewing.

Blooming — A situation in which too many photons are being produced to be received by a pixel. The pixel overflows and causes the photons to go to adjacent pixels. Blooming is similar to overexposure in film photography, except that in digital imaging, the result is a number of vertical and/or horizontal streaks appearing from the light source in the picture.

Baud Rate — The number of discrete signal events per second; bits per second.

Capture — The act of acquiring and storing video images in an imager or host computer. Also, the image captured.

CCD — See **Charge-Coupled Device**.

Charge-Coupled Device (CCD) — A semiconductor device with an array of light-sensitive elements that converts light images into electrical signals.

Check Character — A Modulus 43 or Modulus 10 character that is added to encoded symbol data for additional data integrity.

CMOS — See **Complementary Metal Oxide Semiconductor**.

Complementary Metal Oxide Semiconductor (CMOS) — Like CCDs, CMOS imagers include an array of photo-sensitive diodes, one diode within each pixel. Unlike CCDs, however, each pixel in a CMOS imager has its own individual amplifier integrated inside.

Connector — A plug or socket on a device or cable providing in/out connectivity for various circuits and pins.

Concentrator — Intermediary device that relays data from imagers to a host and commands from the host to the imagers or other devices.

Counter — Memory space allocated to keep track of imager events.

DAC — See **Digital-to-Analog Converter**.

Daisy Chain — Linkage of primary and secondary imagers allowing data to be relayed up to the host via auxiliary port connections.

Decode — A **Good Read**. The successful interpretation and output of the information encoded in a symbol.

Default — Restores **ROM** or flash settings, initializes serial commands and resets all counters.

Delimited — A delimited command or field is bracketed by predefined characters.

Decode Rate — The number of good reads per second achieved by an imager.

Darkfield Illumination — Lighting of objects, surfaces, or particles at very shallow or low angles, so that light does not directly enter a reader's optical hardware.

Depth-of-Field — The in-focus range of an imaging system. Measured from the distance behind an object to the distance in front of the object with all objects appearing in focus.

Diffused Lighting — Scattered soft lighting from a wide variety of angles used to eliminate shadows and specular glints from profiled, highly reflective surfaces.

Digital-to-Analog Converter (DAC) — A **VLSI** circuit used to convert digitally processed images to analog for display on a monitor.

Digital Imaging — Conversion of an image into pixels by means of an **Analog-to-Digital Converter** where the level of each pixel can be stored digitally.

Digital Signal Processor (DSP) — A **VLSI** chip designed for ultra-high-speed arithmetic processing. Often imbedded in a vision engine.

Discrete I/O — Inputs and outputs characterized by discrete signal transitions from one voltage level to another so that digital switching can occur.

Direct Memory Access (DMA) — A capability provided by some computer bus architectures that allows data to be sent directly to memory from an attached device.

DMA — See **Direct Memory Access**.

DSP — See **Digital Signal Processor**.

Dynamic Range — The difference between the minimum and maximum thresholds of discernible images; the amount of usable signal.

Edge Enhancement — Image processing method to strengthen high-spatial frequencies in the image.

EPROM — See **Erasable Programmable Read-Only Memory**.

Embedded Memory — Onboard memory device such as **EPROM** or flash.

End of Read Cycle — The time or condition at which the imager stops expecting symbol information to decode.

Erasable Programmable Read-Only Memory (EPROM) — A memory chip that retains data when its power supply is turned off; “non-volatile memory”.

External Edge — Allows a read cycle to be initiated by a trigger signal from an object detector when it detects the appearance of an object (rising edge). The read cycle ends with a good read, a timeout, or a new trigger.

External Level — Allows a read cycle to be initiated by a trigger signal from an object detector. The read cycle ends when the object moves out of the detector’s range.

Falling Edge — A change of state (to inactive) associated with a level trigger.

Field-Programmable Gate Array (FPGA) — A semiconductor device containing programmable interconnects and logic components.

Fill Factor — Percentage of pixel area used for light collection.

Firmware — Software hard-coded in non-volatile memory (**ROM**), and closely tied to specific pieces of hardware.

Fixed Symbol Length — Increases data integrity by ensuring that only one symbol length will be accepted.

Focal Distance — In camera-based vision, the distance from the front of the camera to the object being viewed. (In optics, the distance from the lens to the focal plane.)

Focal Plane — Usually found at the image sensor, it is a plane perpendicular to the lens axis at the point of focus (→).

Focus — Any given point in an image at which light converges; the focal point.

FPGA — See **Field-Programmable Gate Array**.

Frame — The total area captured in an image sensor while the video signal is not blanked.

Frame Grabber — A device that interfaces with a camera and, on command, samples the video, converts the sample to a digital value and stores that in a computer's memory.

Front End System — The object, illumination, optics and imager blocks of a vision system. Includes all components useful to acquire a good image for subsequent processing.

Full Duplex — A communications system in which signals can travel simultaneously between devices.

Gain — The amount of energy applied to pixel gray scale values prior to output, expressed in dB; optimal signal strength.

Good Read — A decode. The successful scanning and decoding of the information encoded in a bar code symbol.

Gradient — The rate of change of pixel intensity (first derivative).

Gray Scale — Variations of values from white, through shades of gray, to black in a digitized image with black assigned the value of zero and white the value of one.

Half Duplex — A communications system in which signals can travel between devices in both directions, but not simultaneously.

Histogram — A graphical representation of the frequency of occurrence of each intensity or range of intensities (gray levels) of pixels in an image. The height represents the number of observations occurring in each interval.

Host — A computer, **PLC**, or other device that is used to execute commands and process data and discrete signals.

Image — Projection of an object or scene onto a plane (i.e. screen or image sensor).

Image Processing (IP) — Transformation of an input image into an output image with desired properties.

Image Resolution — The number of rows and columns of pixels in an image. A higher resolution means that more pixels are available per element of the symbol being read. Examples: 640 x 480 (VGA); 854 x 480 (WVGA); 1280 x 1024 (SXGA); 2048 x 1536 (QXGA).

Image Sensor — A device that converts a visual image to an electrical signal; a **CCD** or **CMOS** array.

Initialize — Implement serial configuration commands into the imager's active memory.

Input — A channel or communications line. Decoded data or a discrete signal that is received by a device.

Integration — Exposure of pixels on a **CMOS** sensor.

IP — See **Image Processing**.

Ladder Orientation — A linear symbol orientation in which the bars are parallel to the symbol's direction of travel.

LED — See **Light-Emitting Diode**.

Light-Emitting Diode (LED) — A semiconductor device that emits light when conducting current.

Lens — A transparent piece of material with curved surfaces which either converge or diverge light rays.

Machine Vision — The automatic acquisition and analysis of images to obtain desired data for controlling a specific activity.

Multidrop — A communications protocol for networking two or more imagers or other devices with a concentrator (or controller) and characterized by the use of individual device addresses and the RS-485 standard.

Noise — The same as static in a phone line or "snow" in a television picture, noise is any unwanted electrical signal that interferes with the image being read and transferred by the imager.

Normally Closed — A discrete output state that is only active when open.

Normally Open — A discrete output state that is only active when closed.

Object Plane — An imaginary plane in the field of view, focused by an imager's optical system at the corresponding image plane on the sensor.

Output — A channel or communications line. Data or discrete signals that are transmitted or displayed by a device.

Parity — An error detection routine in which one data bit in each character is set to **1** or **0** so that the total number of **1** bits in the data field is even or odd.

Picket Fence Orientation — A linear symbol orientation in which the bars are perpendicular to the symbol's direction of travel.

Pitch — Rotation of a linear or 2D symbol around an axis parallel to the symbol length on the **Substrate**. See the illustration below.

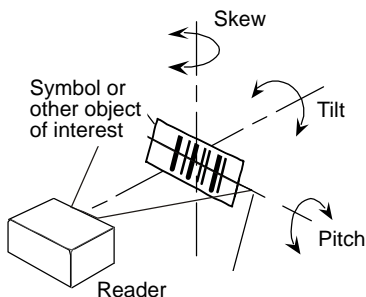

Pixel — An individual element in a digitized image array; “picture element”.

PLC — See **Programmable Logic Controller**.

Port — Logical circuit for data entry and exit. (One or more ports may be included within a single connector.)

Processing Time — The time used by a vision system to receive, analyze and interpret image information. Often expressed in “parts per minute”.

Programmable Logic Controller (PLC) — An electronic device used in industrial automation environments such as factory assembly lines and automotive manufacturing facilities.

Progressive Scan — A non-interlaced scan that doubles the number of visible picture lines per field by displaying all picture lines at once.

Protocol — The rules for communication between devices, providing a means to control the orderly flow of information between linked devices.

RAM — See **Random Access Memory**.

Random Access Memory (RAM) — A data storage system used in computers, composed of integrated circuits that allow access to stored data in any sequence without movement of physical parts.

Read Cycle — A programmed period of time or condition during which a reader will accept symbol input.

Read-Only Memory (ROM) — A data storage medium used in computers and other electronics, primarily used to distribute **Firmware**.

Real-Time Processing — In machine vision, the ability of a system to perform a complete analysis and take action on one part before the next one arrives for inspection.

Glossary of Terms

Region — Area of an image. Also called a region of interest for image processing operations.

ROM — See **Read-Only Memory**.

Saturation — The degree to which a color is free of white. One of the three properties of color perception, along with hue and value.

Scattering — Redirection of light reflecting off a surface or through an object.

Skew — Rotation of a linear or 2D symbol around an axis parallel to the symbol height on the substrate. See the illustration under the definition of **Pitch**.

Substrate — The surface upon which a linear or 2D symbol is printed, stamped, or etched.

Symbol Transitions — The transition of bars and spaces on a symbol, used to detect the presence of a symbol on an object.

Symbology — A symbol type, such as Code 39 or Code 128, with special rules to define the widths and positions of bars and spaces to represent specific numeric or alphanumeric information.

Tilt — Rotation of a linear or 2D symbol around an axis perpendicular to the substrate. See the illustration under the definition of **Pitch**.

Trigger — A signal, transition, or character string that initiates a read cycle.

Very Large-Scale Integration (VLSI) — The creation of integrated circuits by combining thousands of transistor-based circuits on a single chip.

VLSI — See **Very Large-Scale Integration**.

Watchdog Timer — A security device that detects system crashes and attempts to reset the imager.

Hyperlink Index

A

A/D Converter
Aberration
About the Quadrus MINI 3 Imager
About This Manual
Absorption
ACK / NAK (Main Port)
ACK / NAK Data Flow Examples
ACK / NAK Options
ACK/NAK
Active Illumination
Adaptive Contrast Percent
ADC
Add / Remove Exception
Add Macro
Additional Notes about Calibration
Advanced Options
After Calibration
AGC
All Descriptor Status Request
All Range Status Request
All Status Request
Always Ask Before Auto Sync Occurs
Ambient Light
Analog
Analog-to-Digital Converter
Any Symbology (Add 1)
Appendices
Application Mode
Application Record Brackets (Code 128 / EAN 128)
Application Record Padding (Code 128 / EAN 128)
Application Record Separator Character (Code 128 / EAN 128)
Application Record Separator Status (Code 128 / EAN 128)
Application-Specific Integrated Circuit
Architecture
ASCII Character Entry Modifier
ASCII Table
ASIC
Ask to Save ESP File when Quitting
Aspect Ratio
Australia Post

B

Australia Post Allow 0 FCC
Auto (FLM)
Auto Sync
Autoconnect
Automatic Gain Control
Auxiliary Port
Auxiliary Port Connections
Auxiliary Port Mode
Auxiliary Port System Data Status
Axial Non-Uniformity (Data Matrix Only)
Axial Non-Uniformity Threshold (ISO/IEC 16022 Symbol Quality Output 1)
Aztec Code
Aztec Code (Add 131072)

B

Background Color
Background Color (Configuration Database)
Bad Symbol (Trend Analysis Output 1)
Bad Symbol Message
Bad/No Symbol Output (Dimension Mode)
Bad/No Symbol Output (Orientation Mode)
Bad/No Symbol Output (Symbol Size Mode)
Bar Code Configuration by EZ Button
Bar Code Configuration Mode
Bar Code Dialog
Bar Code Options
Bar Width Status (Pharmacode)
Baud Rate
Baud Rate, Auxiliary Port
Baud Rate, Host Port
BC412
BC412 (Add 2048)
Beeper
Beeper / Green Flash
Before / During Calibration
Begin Transmission
Black Background
Blooming
Both Standard Mode and Q-Mode
Both UPC / EAN Supplemental Types
Both White and Black

C

- Calibrate
- Calibrate by ESP
- Calibrate by EZ Button
- Calibrate by Serial Command
- Calibrate in EZ Mode
- Calibration
- Calibration (Camera and IP Setup)
- Calibration by ESP
- Calibration Options
- Calibration Overview
- Calibration Progress Indicators
- Calibration Progress Output Examples (Terminal)
- Calibration Progress Output to Terminal
- Calibration Serial Commands
- Camera and IP Setup
- Camera and IP Setup by ESP
- Camera and IP Setup Serial Commands
- Camera Settings
- Capture
- Capture and Decode
- Capture Mode
- Capture Text
- Capture Time
- Capture Timing
- CCD
- CE Mark
- Change Background Color
- Change Echo Font
- Change Font
- Change Keyboard Macros
- Changing the COM Port (USB-to-Serial Virtual COM Port Driver)
- Charge-Coupled Device
- Check Character
- Check Character Output (BC412)
- Check Character Output (Codabar)
- Check Character Output Status (Code 39)
- Check Character Output Status (Interleaved 2 of 5)
- Check Character Status (Code 39)
- Check Character Status (Interleaved 2 of 5)
- Check Character Type (Codabar)
- Check Required Hardware
- Cleaning the Imager
- Clear
- CMOS
- Codabar

C

- Codabar (Add 32)
- Code 128 (Add 8)
- Code 128 / EAN 128
- Code 39
- Code 39 (Add 16)
- Code 93
- Code 93 (Add 64)
- Codeword Collection (PDF417)
- Color Processing
- Color Processing Disabled
- Column (WOI Framing)
- Column Pointer (Configuration Database)
- Column Width (Configuration Database)
- Command Processing Mode
- Command Response from Imager to Host
- Commands from Host to Imager
- Communication Port (Image Output)
- Communication Protocol Command Table
- Communication Protocols
- Communications
- Communications by ESP
- Communications Protocol
- Communications Protocol Command Table
- Communications Serial Commands
- Complementary Metal Oxide Semiconductor
- Composite
- Composite Enabled
- Composite Required
- Concatenating Configuration Commands
- Concentrator
- Configurable Output 1
- Configurable Output 2
- Configurable Output 3
- Configuration Database
- Configuration Database (Camera and IP Setup)
- Configuration Database Serial Commands
- Configuration Database Status
- Configuration Exceptions for USB
- Configuration Setting Changes
- Configuration Symbols (Data Matrix with Configure Reader Flag)
- Configure the Imager in ESP
- Configuring EZ Trax Output
- Configuring EZ Trax Output by ESP
- Configuring EZ Trax Output by Serial Command
- Connect the System

D

- Connect to Readers via TCP/IP
- Connecting by RS-232 / RS-422 / RS-485
- Connector
- Connector Specifications
- Constant Illumination
- Continuous Capture
- Continuous Read
- Continuous Read 1 Output
- Control Characters
- Control/Hex Output
- Copy
- Counter
- Counters
- Counters by ESP
- Counters by Serial Command
- Customer Default Parameters
- Cycle Max
- Cycle Min
- Cycle Step

D

- DAC
- Daisy Chain
- Daisy Chain Autoconfigure
- Daisy Chain ID
- Daisy Chain ID Status
- Daisy Chain Mode
- Damaged Symbol
- Darkfield Illumination
- Data (Output Filter Configuration)
- Data Bits, Auxiliary Port
- Data Bits, Host Port
- Data Matrix
- Data Matrix (Add 2)
- Data Matrix ECC 000
- Data Matrix ECC 050
- Data Matrix ECC 080
- Data Matrix ECC 100
- Data Matrix ECC 120
- Data Matrix ECC 130
- Data Matrix ECC 140
- Data Matrix ECC 200
- Data Matrix Output Mode
- Data Originating from the Auxiliary Port (Full Duplex Mode)

D

Data Originating from the Auxiliary Port (Half Duplex Mode)
Data Originating from the Host (Full Duplex Mode)
Data Originating from the Host (Half Duplex Mode)
Data Originating from the Host (Transparent Mode)
Data Originating from the Imager (Full Duplex Mode)
Data Originating from the Imager (Half Duplex Mode)
Data Originating from the Imager (Transparent Mode)
DataBar Expanded (RSS Expanded)
DataBar Expanded (RSS Expanded) (Add 32768)
DataBar Limited (RSS Limited)
DataBar Limited (RSS Limited) (Add 16384)
DataBar-14 (RSS-14)
DataBar-14 (RSS-14) (Add 8192)
Database Identifier Output
Database Identifier Output Separator
Database Identifier Output Status
Database Identifier Output Status Disabled
Database Identifier Output Status Enabled
Database Index (Output Filter Configuration)
Database Mode
Decode
Decode Rate
Decode Time
Decodes per Trigger Status (Quality Output)
Decodes/Trigger (Trend Analysis Output 1)
Decodes/Trigger Threshold (Output 1)
Decrement Focus Position
Default
Default / Reset / Save
Default Macros
Default on Power-On
Default on Power-On by EZ Button
Default Settings
Defaulting
Defaults
Delete Master Symbol Data
Delimited
Depth-of-Field
Detailed No Read Message
Device Control
Device Control by ESP
Device Control by Serial Command
Diagnostic Warning (Output 1)
Diagnostics Output 1
Diagnostics Output 2

E

Diagnostics Output 3
Differences from Default
Diffused Lighting
Digital Imaging
Digital Signal Processor
Digital-to-Analog Converter
Dimension 1
Dimension 2
Dimension Mode
Dimension Mode Disabled
Dimension Tolerance
Direct Memory Access
Direction (Pharmacode)
Disable Reader
Disclaimer
Discrete I/O
Discrete I/O Specifications
Display Command Wildcard
Display Incoming Data Even When Not in Focus
DMA
Do Not Send or Receive Settings
Document Memo
Downloading Application Code
Downloading ESP from the Web
DSP
Dynamic Range
Dynamic Setup

E

EAN 128 Status (Code 128 / EAN 128)
EAN Status
Edge Enhancement
Editing a Macro
Effects of Protocol Commands
Electrical Specifications
Embedded Memory
Enable Both (Dimension Mode)
Enable Both (Orientation Mode)
Enable Both (Symbol Size Mode)
Enable Echo
Enable PDF Information
Enable Reader
Enable Send and Save as Customer Defaults
End of Read Cycle

F

End of Read Cycle Mode
End Read Rate Test
Enhanced (Non-Printable Characters)
Enhanced Format
Enter Decodes / Second Test
Enter Master Symbol Data
Enter Percent Test
Entering and Using Master Symbols
Entering Control Characters in Serial Commands
Environmental Specifications
EPROM
Erasable Programmable Read-Only Memory
Error Correction Level (Data Matrix Only)
ESP System Requirements
Evaluation
Explanation of Modifiers for Code 39, Codabar, and I-2/5
Explanation of Modifiers for Other Symbologies
External Edge
External Level
External Trigger Polarity
Extract Range
EZ Button
EZ Button Configuration
EZ Button Disabled
EZ Button Modes
EZ Button Operation
EZ Button Trigger
EZ Mode
EZ Trax Comm Port
EZ Trax Grade Output
EZ Trax Image Format
EZ Trax Image Mode
EZ Trax JPEG Quality
EZ Trax Object Info Output
EZ Trax Output

F

Falling Edge
Fast Linear Mode
Fast Linear Mode (FLM) Direction
Fast Shutter
Field-Programmable Gate Array
File
File Format (Image Output)

Fill Factor
Filter Number
Filter Number (Output Filter Configuration)
Find
Find Next
Find Previous
Finder Pattern Status
Fine-Tune Pass (Calibration Progress Output Examples)
Firmware
Firmware by ESP
Firmware Update
Firmware Verification
First Mode (Image Storage Mode)
FIS Options
Five Characters Only (UPC / EAN Supplemental Type)
Fixed Symbol Length
Fixed Symbol Length (BC412)
Fixed Symbol Length (Code 128 / EAN 128)
Fixed Symbol Length (Code 39)
Fixed Symbol Length (DataBar Expanded)
Fixed Symbol Length (MicroPDF417)
Fixed Symbol Length (PDF417)
Fixed Symbol Length (Pharmacode)
Fixed Symbol Length Status (BC412)
Fixed Symbol Length Status (Codabar)
Fixed Symbol Length Status (Code 128 / EAN 128)
Fixed Symbol Length Status (Code 39)
Fixed Symbol Length Status (Code 93)
Fixed Symbol Length Status (DataBar Expanded)
Fixed Symbol Length Status (MicroPDF417)
Fixed Symbol Length Status (PDF417)
Fixed Symbol Length Status (Pharmacode)
Fixed Threshold Value
Fixed Threshold Value (Configuration Database)
Fixed Threshold Value (Pharmacode)
Focal Distance
Focal Distance (Configuration Database)
Focal Distance Table (Read-Only)
Focal Plane
Focus
Focus Pass (Calibration Progress Output Examples)
Focus Position
Focus Position Disabled
Font
Force Connect

G

Format Assign
Format Assign by ESP
Format Assign Status
Format Extract
Format Extract by ESP
Format Insert
Format Insert by ESP
Format UPC-E as UPC-A (UPC / EAN)
Four Beeps (EZ Button Position #4)
FPGA
Frame
Frame Count/Time
Frame Grabber
Frame Information
Front End System
Full ASCII Set (Code 39)
Full Duplex
Full Duplex Mode
Full Image Size (2048 x 1536)
Function Keys

G

Gain
Gain (Calibration Options)
Gain (Camera Settings)
Gain (Configuration Database)
General Purpose Color Processing
General Specifications
Global EZ Button Status
Global Status Disabled
Global Status Enabled
Glossary of Terms
Good Read
Good Read (Symbol Data Output Status)
Good Read / Match Counter (or Good Read Counter)
Good Read / Match Counter Reset
Grade (Data Matrix Output Mode)
Gradient
Gray Scale
Green Flash Duration
Green Flash Mode
Green Flash Mode Disabled
Green Flash on Good Read
Green Flash on Match

Green Flash Strobe
GS1 DataBar (RSS)
Guard Bar Status (Interleaved 2 of 5)

H

Half Duplex
Half Duplex Mode
Hardware Configuration
Hardware Default
Hardware Required
Height (Row Depth)
Hex String (Format Insert)
Hex Values
Highlighting
Histogram
Hollow Mode
Horizontal (FLM)
Horizontal Linear (1D) Symbols (Color Processing)
Host
Host Communications
Host Connector / Pin Assignments
Host Port Connections
Host Port Protocol
Hours Since Reset

I

I/O Parameters
I/O Parameters by ESP
I/O Parameters Serial Commands
Illumination Brightness
Image
Image Dimensions
Image Library Request
Image Output
Image Output Example
Image Output on Good Read
Image Output on Mismatch
Image Output on No Read
Image Output on No Read or Good Read
Image Process Looping
Image Process Looping Disabled
Image Process Looping Enabled
Image Processing

J

- Image Processing Timeout
- Image Resolution
- Image Sensor
- Image Storage
- Image Storage Example
- Image Storage Mode
- Image Storage Type
- Image Storage Type Disabled/Clear
- Imager and Symbol Orientation
- Imager Status Requests
- Implementing the Host Operating System
- Import/Export
- In Read Cycle (Output 1)
- Increment Focus Position
- Index (Configuration Database)
- Indicators
- Initialize
- Initiating Calibration
- Input
- Install ESP
- Installing ESP from a CD
- Installing the USB-to-Serial Virtual COM Port Driver
- Integration
- Interface Standards
- Interleaved 2 of 5
- Interleaved 2 of 5 (Add 128)
- IP
- IP Mode
- IP Threshold
- ISO Certification
- ISO/IEC 16022 Axial Non-Uniformity (Data Matrix Only)
- ISO/IEC 16022 Grade (LED Configuration)
- ISO/IEC 16022 Print Growth
- ISO/IEC 16022 Symbol Contrast
- ISO/IEC 16022 Symbol Quality Output
- ISO/IEC 16022 Symbol Quality Output 1
- ISO/IEC 16022 Symbol Quality Output 2
- ISO/IEC 16022 Symbol Quality Output 3
- ISO/IEC 16022 Symbol Quality Output by ESP
- ISO/IEC 16022 Unused Error Correction (Data Matrix Only)

J

- Japan Post
- JPEG Quality (Image Output)

K

Keyboard IN Reports
Keyboard IN Reports Disabled
Keyboard IN Reports Enabled
Keyboard Macros
Keyboard Report Format
KIX

L

Ladder Orientation
Large Intercharacter Gap (Codabar)
Large Intercharacter Gap (Code 39)
Last Frame (End of Read Cycle Mode)
Last Frame or New Trigger (End of Read Cycle Mode)
Last Mode (Image Storage Mode)
Latch Mode 2 (Unlatch Opposite Condition) (Output 1)
Latch Mode 3 (Unlatch Re-enter Read Cycle) (Output 1)
Latest Manual Version
Leading Edge Trigger Filter
LED
LED Aperture Window
LED Configuration
Left (Column Pointer)
Length (Format Extract)
Length (Format Insert)
Length (Output Filter Configuration)
Lens
Light Collection Options
Light Emitting Diode
Light Source Specification
Limitation of Liability
Line Scan
Line Scan Height
Line Speed (Skew Correction)
Linear / Stacked Symbology Qualification
Linear Symbols (No Read Message Mode)
Load Configuration Database by EZ Button
Load Current Settings from Configuration Database
Load Current Settings from Configuration Database by ESP
Load New Master by EZ Button
Locate by ESP
Locate by EZ Button
Locate the Symbol in the Field of View

M

Locate Time
Longitudinal Redundancy Check
LRC Status

M

Machine Vision
Macro Name
Macro Value
Macros
Master Database
Master Database Overview
Master Symbol Database Size
Match (Symbol Data Output Status)
Match Length
Match or Good Read (Output 1)
Match Replace
Match Start Position
Matchcode
Matchcode by ESP
Matchcode Serial Commands
Matchcode Type
Matrix Size (Data Matrix Only)
Mechanical Specifications
Medium Pass (Calibration Progress Output Examples)
Menu Toolbar
Micro Density Read Range
Micro QR Code
Micro QR Code (Add 65536)
MicroPDF417
MicroPDF417 (Add 1024)
Microscan Default Parameters
Microscan ESP Help
Microscan HID IN Reports
Microscan HID IN Reports Disabled
Microscan HID IN Reports Enabled
Microscan HID Report Format
Microscan Symbol Quality Output
Microscan Symbol Quality Output by ESP
Minimum Good Reads
Minimum Number of Bars
Minimum Number of Bars (Pharmacode)
Minimum Number of Qualified Scan Lines
Minutes Since Reset
Mirrored Image

N

Mismatch
Mismatch (Output 1)
Mismatch (Symbol Data Output Status)
Mismatch (Trend Analysis Output 1)
Mismatch Counter
Mismatch Counter Reset
Mismatch or No Read (Output 1)
Mismatch Replace
Model
Model Memo
Mounting the Imager
Multidrop
Multisymbol
Multisymbol Separator

N

Narrow Margins
Narrow Margins (Configuration Database)
Narrow Margins 2D Enhanced
Narrow Margins Enabled
Narrow Margins/Symbology Identifier
Navigating in ESP
New ESP File
New Master Load Status
New Master Pin
New Model
New Trigger (End of Read Cycle Mode)
Next Row
No Read (Output 1)
No Read (Trend Analysis Output 1)
No Read Counter
No Read Counter Reset
No Read Message
No Read Message Mode
No Read Message Mode Disabled
No Read Message Mode Enabled
No Symbol (Trend Analysis Output 1)
No Symbol Message
Noise
Non-Printable Characters
Normally Closed
Normally Open
Notes on Symbol Type
Number of Active Indexes

O

- Number of Active Indexes by ESP
- Number of Captures
- Number of Focal Distances
- Number of Image Frames (Switch Mode)
- Number of Symbols
- Number of Symbols in Field of View
- Number to Output On (Output 1)

O

- Object Detector
- Object Plane
- Object Qualification (Dimension Mode)
- Object Qualification (Orientation Mode)
- Object Qualification (Symbol Size Mode)
- Open Image after Save
- Open/Save
- Operational Tips
- Optics
- Options
- Ordered Output Filter
- Orientation Mode
- Orientation Mode Disabled
- Orientation Value
- Other Operational Serial Commands
- Output
- Output 1 Pulse
- Output 2 Pulse
- Output 3 Pulse
- Output Coordinates
- Output Coordinates Disabled
- Output Coordinates Enabled
- Output Filter Configuration
- Output Filter Configuration Rule # 1
- Output Filter Configuration Rule # 2
- Output Filter Configuration Rule # 3
- Output Format
- Output Format (Code 128 / EAN 128)
- Output Format Serial Commands
- Output Format Status
- Output Format Status by ESP
- Output Format Status Disabled
- Output Format Status Enabled
- Output Frame Number
- Output Frame Number Disabled

Output Frame Number Enabled
Output Index (Format Extract)
Output Index (Format Insert)
Output Indicators
Output Mode (Output 1)
Output on Axial Non-Uniformity (ISO/IEC 16022 Symbol Quality Output 1)
Output on Print Growth (ISO/IEC 16022 Symbol Quality Output 1)
Output on Symbol Contrast (ISO/IEC 16022 Symbol Quality Output 1)
Output on Unused Error Correction (ISO/IEC 16022 Symbol Quality Output 1)
Output State (Output 1)
Output Symbol Data as Soon as Possible
Output Symbol Data at End of Read Cycle
Overview of Matchcode
Overview of Symbol Quality

P

Parameter Switch (Global EZ Button Status)
Parity
Parity, Auxiliary Port
Parity, Host Port
Parse Table
Paste
Pause
PDF417
PDF417 (Add 512)
Percent Cell Damage (Data Matrix Only)
Pharmacode
Pharmacode (Add 4096)
Picket Fence Orientation
Pitch
Pixel
Pixel Sub-Sampling
Pixel Sub-Sampling (Configuration Database)
Pixel Sub-Sampling 16-to-1
Pixel Sub-Sampling 4-to-1
Pixels Per Element (Data Matrix Only)
Placeholder (Output Filter Configuration)
PLANET Status
PLC
Point-to-Point (Main Port)
Point-to-Point (Standard)
Point-to-Point with RTS/CTS
Point-to-Point with RTS/CTS and XON/XOFF
Point-to-Point with XON/XOFF

P

Poll Address
Polling Mode
Polling Mode (Main Port)
Polling Mode Data Flow Examples
Polling Mode Options
Port
Position Imager and Symbol
Postal Symbologies
Postal Symbologies (Add 262144)
Postal Symbology Type
Postamble
Postamble Characters
Postamble Status
POSTNET Allow B and B' Fields
POSTNET Status
Power-On (Power-On / Reset Counts)
Power-On / Reset Counts
Power-On Flash Saves (Power-On / Reset Counts)
Power-On Saves (Power-On / Reset Counts)
Preamble
Preamble Characters
Preamble Status
Preferences > Advanced Tab
Preferences > Bar Code Options Tab
Preferences > General Tab
Preferences > Terminal Tab
Pre-Processing
Pre-Processing Disabled
Pre-Processing Enabled
Print Growth Threshold (ISO/IEC 16022 Symbol Quality Output 1)
Processing
Processing Definable
Processing High
Processing Low
Processing Medium
Processing Mode (Configuration Database)
Processing Time
Programmable Logic Controller
Progressive Scan
Protocol
Protocol Command Mnemonics
Protocol Configuration Examples
Pulse (Output 1)
Pulse Width (Output 1)

Q**Q**

- Q-Mode
- QR Code
- QR Code (Add 4)
- Quadrus MINI 3 Imager
- Quadrus MINI 3 Imager Dimensions
- Quality Output
- Quality Output Separator
- Quick Focus
- Quick Focus (Calibration Progress Output Examples)
- Quick Start
- Quiet Zone (Data Matrix Only)

R

- RAM
- Random Access Memory
- Range Mode Status (Interleaved 2 of 5)
- Rapid Capture
- Rapid Capture Mode
- Read Cycle
- Read Cycle by ESP
- Read Cycle Serial Commands
- Read Cycle Setup
- Read Cycle Timeout (End of Read Cycle Mode)
- Read Duration Output
- Read Duration Output Mode
- Read Duration Output Separator
- Read Next Symbol as Master Symbol
- Read Parameters
- Read Ranges
- Read Rate (Utilities)
- Read Rate by ESP
- Read Rate by EZ Button
- Read Rate by Serial Command
- Read Rate LEDs
- Read Symbol into Selected Index
- Read-Only Memory
- Real-Time Processing
- Receive After Connect
- Receive Settings from the Reader
- Receiving
- Region
- Region of Interest (ROI)

S

- Region of Interest (ROI) by ESP
- Regular and Mirrored Image
- Regular Image
- Reload Last File
- Replacement String (Match)
- Replacement String (Mismatch)
- Report Options
- Request All Configuration Database Settings
- Request All Master Symbol Data
- Request Checksum by ESP
- Request Checksum by Serial Command
- Request Master Symbol Data
- Request New Master Status
- Request Part Number by ESP
- Request Part Number by Serial Command
- Request Selected Index Settings
- Resets
- Resets (Power-On / Reset Counts)
- RES-NAK Defaults (ACK/NAK Options)
- RES-NAK Defaults (Polling Mode Options)
- Response Timeout
- ROM
- Row (WOI Framing)
- Row and Column (WOI Framing)
- Row Depth (Configuration Database)
- Row Pointer (Configuration Database)
- Royal Mail
- RS-232 Interface Standard
- RS-232 Protocol
- RS-422 / 485 Interface Standard
- RS-422 Status
- Rules for Output Filter Configuration
- Rules for Utility and Configuration Commands

S

- Safety Certifications
- Saturation
- Save
- Save As
- Save Configuration in ESP
- Save Current Settings to Configuration Database
- Save Current Settings to Configuration Database by ESP
- Save Current Text
- Save for Power-On

S

Save for Power-On by EZ Button
Saved for Power-on
Saving
Saving Options
Scattering
Search Method Enabled
Search Pass (Calibration Progress Output Examples)
Select All
Select Model
Select Protocol and Connect
Send
Send and Save
Send and Save as Customer Defaults
Send Current Command
Send Current View
Send Database to the Reader
Send ESP Settings to the Reader
Send File
Send XON with Autoconnect
Send, No Save
Send/Receive Options
Send/Recv
Separator Character (Composite)
Separator Character (UPC / EAN)
Separator Status (Composite)
Separator Status (UPC / EAN)
Sequence on Mismatch
Sequence on No Read
Sequential Matching
Serial Command Beep Status
Serial Command Echo Status
Serial Command Format
Serial Command Status Request
Serial Configuration Command Conventions
Serial Configuration Commands
Serial Configuration K Commands
Serial Data
Serial Data and Edge
Serial Trigger
Serial Trigger Character (Delimited)
Serial Utility Commands
Serial Verification
Service Message
Service Message Resolution
Service Message Threshold

S

Service Unit (Diagnostics Output 1)
Setting Up the Imager for EZ Trax
Show Connect Prompt
Show Model Prompt
Show Non-Printable Characters
Show Target Pattern During Calibrate
Show Target Pattern During Locate
Shutter Speed (Calibration Options)
Shutter Speed (Camera Settings)
Shutter Speed (Configuration Database)
Shutter Speed Disabled
Shutter Speed Enabled
Single Beep (EZ Button Position #1)
Single Descriptor Status Request
Single Range Status Request
Single Status Request
Sizing Information
Skew
Skew Correction
Skew Correction Notes
Skip EZ Mode
Software Defaults
Standard (Non-Printable Characters)
Standard Density and Micro Density Optics
Standard Density Read Range
Standard LED Configuration
Standard Mode
Start / Stop Match (Codabar)
Start / Stop Output (Codabar)
Start Location (Format Extract)
Start Trigger Character (Non-Delimited)
Start/Stop Status
Statement of Agency Compliance
Static Presentation Mode
Status Byte
Stop
Stop Bits, Auxiliary Port
Stop Bits, Host Port
Stop Trigger Character (Non-Delimited)
Store on No Read
Store Report without file path prompt
Straight Line (WOI Framing)
Straight Line Framed (WOI Framing)
Substrate
Supplemental Type (UPC / EAN)

Supplementals Status (UPC / EAN)
Switch Mode
Switch Model
Symbol Angle (Data Matrix Only)
Symbol Contrast Threshold (ISO/IEC 16022 Symbol Quality Output 1)
Symbol Data Output
Symbol Data Output Status
Symbol Data Output Status Disabled
Symbol Direction (Skew Correction)
Symbol Length #1 (Interleaved 2 of 5)
Symbol Length #2 (Interleaved 2 of 5)
Symbol Length (Codabar)
Symbol Length (Code 93)
Symbol Number
Symbol Parse
Symbol Quality
Symbol Quality (Output 1)
Symbol Quality by ESP
Symbol Quality Locate Tab
Symbol Quality Preferences Tab
Symbol Quality Report Tab
Symbol Quality Separator
Symbol Quality Separator / Data Matrix Output Mode
Symbol Quality Separator by ESP
Symbol Quality Serial Commands
Symbol Quality Tree Control
Symbol Size 1
Symbol Size 2
Symbol Size Mode
Symbol Size Mode Disabled
Symbol Size Tolerance
Symbol Transitions
Symbol Type
Symbologies
Symbologies by ESP
Symbologies Serial Commands
Symbology
Symbology (Configuration Database)
Symbology Disabled (Configuration Database)
Symbology Identifier
Symbology Specifications
Symbology Type (Output Filter Configuration)

T

Table of Contents
Target Pattern
Target Pattern Always OFF
Target Pattern Always ON
Target Pattern ON When in the Read Cycle
Target Pattern ON When Not in the Read Cycle
Target System by EZ Button
Technical Support
Terminal
Terminal Dropdown Menu
Terminal Window
Terminal Window Menus
Test in EZ Mode
Test Read Rate
Test Read Rate by ESP
Test Read Rate by EZ Button
Test Read Rate by Serial Command
Three Beeps (EZ Button Position #3)
Threshold (Histogram)
Threshold Mode
Threshold Mode (Configuration Database)
Tilt
Time (Switch Mode)
Time Before First Capture
Time Between Captures
Time Since Reset
Timed Capture (Rapid Capture Mode)
Timeout (End of Read Cycle Mode)
Timeout or New Trigger (End of Read Cycle Mode)
Top (Row Pointer)
Total Read Time
Trailing Edge Trigger Filter
Transparent Mode
Trend Analysis (Output 1)
Trend Analysis Mode (Output 1)
Trend Analysis Output 1
Trend Analysis Output 2
Trend Analysis Output 3
Trigger
Trigger Character
Trigger Counter
Trigger Counter Reset
Trigger Evaluation Period (Output 1)
Trigger Mode
Trigger Mode and Filter Duration

U

Triggered Capture (Rapid Capture Mode)
Two Beeps (EZ Button Position #2)
Two Characters Only (UPC / EAN Supplemental Type)
Two-Dimensional Symbology Qualification
Two-Dimensional Symbols (No Read Message Mode)

U

U.S. Post (POSTNET, PLANET, USPS4CB)
Uninstalling the USB-to-Serial Virtual COM Port Driver
Unlatch Outputs (Global EZ Button Status)
Unused Error Correction Threshold (ISO/IEC 16022 Symbol Quality Output 1)
UPC / EAN
UPC / EAN Supplementals Status Disabled
UPC / EAN Supplementals Status Enabled
UPC / EAN Supplementals Status Required
UPC/EAN (Add 256)
UPU
USB HID Configuration Options
USB HID Interface
USB Interface Standard
USB Protocol
USB-to-Serial Virtual COM Port Driver
Use Default Storage Location
Use Higher Quality Images
User-Defined Polling Mode (Main Port)
Using ESP
Using EZ Trax
Utilities

V

Value (Data Matrix Output Mode)
Vertical (FLM)
Very Large-Scale Integration
Video
View
VLSI

W

Warning and Caution Summary
Warranty
Watchdog Timer
When to Output Symbol Data

Y

White Background
White Balance Calibration
Width (Column Width)
Wild Card Character
Wildcard (Output Filter Configuration)
Window of Interest
Window of Interest (WOI) by ESP
Window of Interest (WOI) Framing
Window of Interest (WOI) Margin
Window of Interest by ESP
Window of Interest by Serial Command
WOI Framing Disabled

Y

Y-Modem Download Transfer Options
Y-Modem Upload Transfer Options