

**MICROSCAN.**

# QX Hawk Industrial Imager User Manual



---

## *Copyright and Disclaimer*

Copyright ©2017  
Omron Microscan Systems, Inc.  
Tel: +1.425.226.5700 / 800.762.1149  
Fax: +1.425.226.8250

All rights reserved. The information contained herein is proprietary and is provided solely for the purpose of allowing customers to operate and/or service Omron Microscan manufactured equipment and is not to be released, reproduced, or used for any other purpose without written permission of Omron Microscan.

Throughout this manual, trademarked names might be used. We state herein that we are using the names to the benefit of the trademark owner, with no intention of infringement.

### ***Disclaimer***

The information and specifications described in this manual are subject to change without notice.

### ***Latest Manual Version***

For the latest version of this manual, see the Download Center on our web site at:  
[www.microscan.com](http://www.microscan.com).

### ***Technical Support***

For technical support, e-mail: [helpdesk@microscan.com](mailto:helpdesk@microscan.com).

### ***Warranty***

For current warranty information, see: [www.microscan.com/warranty](http://www.microscan.com/warranty).

## **Omron Microscan Systems, Inc.**

### **United States Corporate Headquarters**

+1.425.226.5700 / 800.762.1149

### **United States Northeast Technology Center**

+1.603.598.8400 / 800.468.9503

### **European Headquarters**

+31.172.423360

### **Asia Pacific Headquarters**

+65.6846.1214

# Table of Contents

Chapter 1	Quick Start	
	Step 1 Check Hardware .....	1-2
	Step 2 Connect the System .....	1-4
	Step 3 Position the Imager .....	1-6
	Step 4 Install ESP .....	1-7
	Step 5 Select Model .....	1-8
	Step 6 Connect .....	1-10
	Step 7 Locate Symbol .....	1-12
	Step 8 Calibrate .....	1-14
	Step 9 Test Read Rate .....	1-15
	Step 10 Configure the Imager .....	1-16
	Step 11 Save Changes .....	1-17
Chapter 2	Using ESP	
	EZ Mode .....	2-2
	App Mode .....	2-3
	Menu Toolbar .....	2-4
	Navigating in ESP .....	2-15
	Send/Receive Options .....	2-16
Chapter 3	Hardware Integration	
	Cordsets .....	3-2
	QX Hawk and QX-1 Connectors and Pinouts .....	3-3
	Power and Trigger Switching .....	3-8
	Port Routing .....	3-9
	Application Examples .....	3-10
Chapter 4	Setup	
	Video .....	4-2
	Evaluation .....	4-18
	Calibration .....	4-21
	Window of Interest .....	4-22
	Configuration Database .....	4-24
	Ordered Output .....	4-33
	Output Format .....	4-37
	Dynamic Setup .....	4-41
Chapter 5	Parameters	
	Communication .....	5-2
	Read Cycle .....	5-42
	Symbologies .....	5-62
	I/O Parameters .....	5-98
	Symbol Quality .....	5-159
	Matchcode .....	5-166
	Diagnostics .....	5-175

---

## Table of Contents

Chapter 6	Terminal	
	Terminal View.....	6-2
	Find .....	6-3
	Send .....	6-4
	Macros.....	6-5
	Terminal Menus.....	6-6
Chapter 7	Utilities	
	Serial Utility Commands .....	7-2
	Read Rate .....	7-4
	Counters .....	7-6
	Device Control .....	7-9
	Differences from Default.....	7-10
	Master Database .....	7-11
	Firmware .....	7-17
	Bar Code Configuration Mode .....	7-21
	Calibration .....	7-22
	Default/Reset/Save .....	7-23
	Imager Status .....	7-25
	Learn Operations.....	7-27
	Reboot System .....	7-28
	Static Validation.....	7-29
	Targeting .....	7-31
	Y-Modem Transfer Options .....	7-32
	Temperature .....	7-34
Appendices		
	Appendix A General Specifications .....	A-2
	Appendix B Electrical Specifications .....	A-11
	Appendix C Ground and Shield Considerations.....	A-20
	Appendix D Flying Lead Cordset Pinouts.....	A-22
	Appendix E Serial Commands .....	A-23
	Appendix F Protocol Commands.....	A-85
	Appendix G ASCII Table .....	A-94
	Appendix H Configuring Ethernet TCP/IP .....	A-95
	Appendix I Using EtherNet/IP .....	A-98
	Appendix J Allen-Bradley Version 16 PLC Setup.....	A-107
	Appendix K Allen-Bradley Version 20 PLC Setup .....	A-120
	Appendix L EIPScan Setup .....	A-132
	Appendix M Interface Standards .....	A-138
	Appendix N Glossary of Terms .....	A-139



# About the QX Hawk Industrial Imager

The key features of the QX Hawk Industrial Imager are:

- Standard and C-Mount versions available
- Fully integrated liquid lens technology
- High-resolution modular optical zoom system
- Simple connectivity with M12 cordsets and connectors
- Best-in-class X-Mode™ algorithms
- Support for Ethernet TCP/IP and EtherNet/IP™
- A green flash, visible from all angles, to signal a successful read
- LED array for performance, communication, and I/O user feedback
- EZ Button for setup and testing
- Compact size for easy integration into a wide variety of applications
- IP65/67 enclosure

## Imager Communication

There are three ways to configure and test the QX Hawk:

- **ESP** (Easy Setup Program), which offers point-and-click ease of use and visual responses to user adjustments.
- Serial commands, such as **<K100,1>**, that can be sent from **ESP's Terminal** or another terminal program.
- The **EZ Button** on the top of the imager.

"EtherNet/IP" is a trademark of the Open DeviceNet Vendors Association.

## Warning and Caution Summary

This equipment has been tested and found to comply with the limits for a Class A digital device, pursuant to part 15 of the FCC Rules. These limits are designed to provide reasonable protection against harmful interference in a residential installation. This equipment generates, uses, and can radiate radio frequency energy, and, if not installed and used in accordance with the instructions, may cause harmful interference to radio communication. However, there is no guarantee that interference will not occur in a particular installation. If this equipment does cause harmful interference to radio or television reception, which can be determined by turning the equipment off and on, the user is encouraged to try to correct the interference by one or more of the following measures:

- Reorient or relocate the receiving antenna;
- Increase the separation between the equipment and receiver;
- Connect the equipment into an outlet on a circuit different from that to which the receiver is connected;
- Consult the dealer or an experienced radio/TV technician for help.

For connection to a UL-listed direct plug-in power unit marked Class II and rated 10 to 28 VDC at 5 watts or greater.

U.S. models must use a similarly rated Class I or Class II power supply that is certified to comply with standards for safety IEC 60950-1 Ed. 2 (2005) and IEC 60825-1 Ed. 3 (2014).

European models must use a similarly rated Class I or Class II power supply that is certified to comply with standard for safety EN 60950-1 (2006) with Am. 11 (2009).

Use of controls, adjustments, or performance of procedures other than those specified herein may result in hazardous laser or LED light radiation exposure.

There are no user-serviceable parts in the imager. Opening the imager voids the Omron Microscan Systems, Inc. warranty.

### Warning Label Placement

This warning label is located on the QX Hawk Industrial Imager:

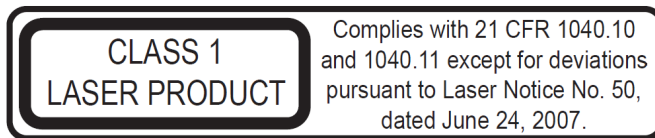

# Statement of Agency Compliance



The QX Hawk has been tested for compliance with FCC (Federal Communications Commission) regulations and has been found to conform to all applicable FCC Rules and Regulations.

To comply with FCC RF exposure compliance requirements, this device must not be co-located or operate in conjunction with any other antenna or transmitter.

Changes or modifications not expressly approved by the party responsible for compliance could void the user's authority to operate the equipment.



The QX Hawk has been tested for compliance with CE (Conformité Européenne) standards and guidelines, and has been found to conform to applicable CE standards, specifically the following requirements:

**General Immunity for Light Industry:** EN 55024:1998 ITE Immunity Standard

**Radiated and Conducted Emissions of ITE Equipment:** EN 55022:98 ITE Disturbances

The QX Hawk has been tested by an independent electromagnetic compatibility laboratory in accordance with the applicable specifications and instructions.

# Statement of RoHS Compliance

All Omron Microscan readers with a 'G' suffix in the FIS number are RoHS-Compliant. All compliant readers were converted prior to March 1, 2007. All standard accessories in the Omron Microscan Product Pricing Catalog are RoHS-Compliant except 20-500013-01 and 98-000039-02. These products meet all the requirements of "Directive 2002/95/EC" European Parliament and the Council of the European Union for RoHS compliance. In accordance with the latest requirements, our RoHS-Compliant products and packaging do not contain intentionally added Deca-BDE, Perfluorooctanes (PFOS) or Perfluorooctanic Acid (PFOA) compounds above the maximum trace levels. To view the document stating these requirements, please visit:

<http://eur-lex.europa.eu/LexUriServ/LexUriServ.do?uri=CELEX:32002L0095:EN:HTML>

and

<http://eur-lex.europa.eu/LexUriServ/LexUriServ.do?uri=OJ:L:2006:372:0032:0034:EN:PDF>

Please contact your sales manager for a complete list of Omron Microscan's RoHS-Compliant products.

This declaration is based upon information obtained from sources which Omron Microscan believes to be reliable, and from random sample testing; however, the information is provided without any representation of warranty, expressed or implied, regarding accuracy or correctness. Omron Microscan does not specifically run any analysis on our raw materials or end product to measure for these substances.

The information provided in this certification notice is correct to the best of Omron Microscan's knowledge at the date of publication. This notice is not to be considered a warranty or quality specification. Users are responsible for determining the applicability of any RoHS legislation or regulations based on their individual use of the product.

In regards to "RoHS Directive 2011\_65\_EU" Omron Microscan produces Monitoring and Control Instruments as well as Industrial Monitoring & Control Instruments as defined within the directive. Omron Microscan has developed and is implementing a RoHS2 compliance plan with the intention of bringing all active products listed in our current marketing literature within full compliance as per the directive deadlines.

Key milestones for the transition plan are as follows:

- Complete internal product audit by July 2014.
- Initial "Monitoring and Control Instruments" RoHS2 compliant products available by December 2014
- Initial "Industrial Monitoring & Control Instruments" RoHS2 compliant products available by July 2015
- All new products introduced in 2015 are expected to be WEEE & RoHS2 compliant.

Omron Microscan will mark the products with the 'CE' marking that complies with the RoHS2 process to acquire 'CE' certification per the example given: Example >> Machinery directive + EMC directive + RoHS2 = Declaration of Conformity.

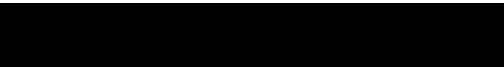

# 1 Quick Start

## Contents

Step 1 Check Hardware.....	1-2
Step 2 Connect the System .....	1-4
Step 3 Position the Imager.....	1-6
Step 4 Install ESP .....	1-7
Step 5 Select Model.....	1-8
Step 6 Connect .....	1-10
Step 7 Locate Symbol.....	1-12
Step 8 Calibrate .....	1-14
Step 9 Test Read Rate .....	1-15
Step 10 Configure the Imager.....	1-16
Step 11 Save Changes.....	1-17

This section explains how to set up and test the QX Hawk quickly using **ESP** (Easy Setup Program). Detailed setup information for installing the imager into an application can be found in subsequent sections.

# Step 1 — Check Hardware

## Standard QX Hawk

Item	Description	Part Number
1	QX Hawk Industrial Imager	FIS-6801-XXXXG
2	QX-1 Interface Device	98-000103-02
3	Cordset, Common, M12 12-pin Socket to M12 12-pin Plug, 1 m	61-000162-02
4	Cordset, Host, Serial, M12 12-pin Plug to DB9 Socket, 1 m	61-000152-02
5	Cordset, Host, Serial, M12 12-pin Socket to DB9 Socket, 1 m	61-000153-02
6	Power Supply, 100-240VAC, +24VDC, M12 12-pin Socket	97-000012-01
7	Cordset, Host, Ethernet, M12 8-pin Plug (Ultra-Lock) to RJ45, 1 m	61-000160-01
or	Cordset, Host, Ethernet, M12 8-pin Plug (Screw-On) to RJ45, 1 m	61-000160-02
8	Photo Sensor, M12 4-pin Plug, NPN, Dark On, 2 m	99-000020-02

**Note:** Additional cordsets and accessories are available in the Microscan Product Pricing Catalog.

**Note:** The QX Hawk does not require an Ethernet crossover cordset, because the imager itself performs automatic internal crossover (transmit-to-receive switching). Microscan offers a standard straight-through (un-crossed) Ethernet cordset (61-000160-01 or -02).

**Important:** Do not attempt to power more than four imagers with a single power supply in a daisy chain configuration. Add a QX-1 and one power supply for every four additional imagers in the daisy chain.

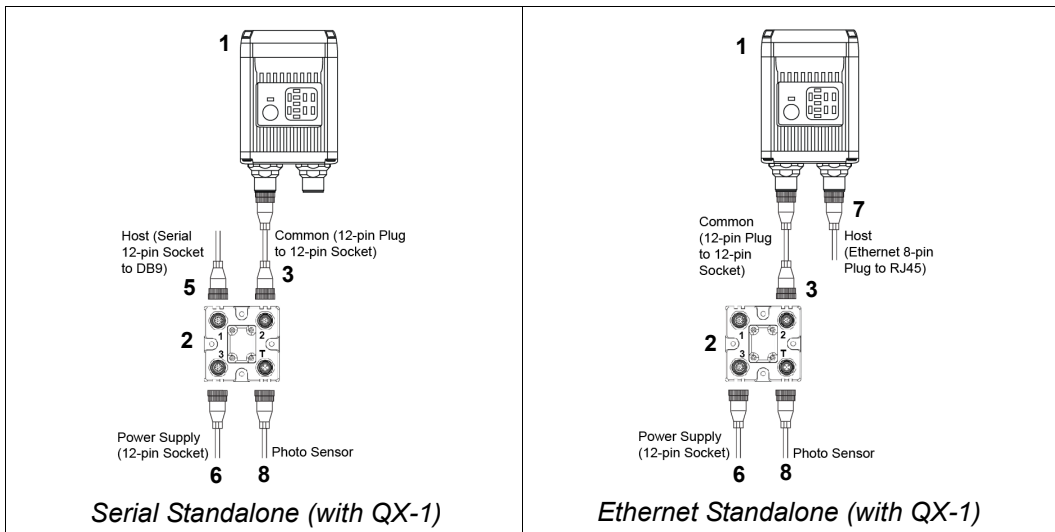

### Hardware Required

**Caution:** Be sure that all connections are secure **BEFORE** applying power to the system. Always power down **BEFORE** disconnecting any cables.

## QX Hawk C-Mount

Item	Description	Part Number
1	QX Hawk C-Mount Industrial Imager	FIS-6801-XXXXG
2	QX-1 Interface Device	98-000103-02
3	Cordset, Common, M12 12-pin Socket to M12 12-pin Plug, 1 m	61-000162-02
4	Cordset, Host, Serial, M12 12-pin Plug to DB9 Socket, 1 m	61-000152-02
5	Cordset, Host, Serial, M12 12-pin Socket to DB9 Socket, 1 m	61-000153-02
6	Power Supply, 100-240VAC, +24VDC, M12 12-pin Socket	97-000012-01
7	Cordset, Host, Ethernet, M12 8-pin Plug (Ultra-Lock) to RJ45, 1 m	61-000160-01
or	Cordset, Host, Ethernet, M12 8-pin Plug (Screw-On) to RJ45, 1 m	61-000160-02
8	Photo Sensor, M12 4-pin Plug, NPN, Dark On, 2 m	99-000020-02
9	Cordset, Smart Series Light to QX-1, ON/OFF (not shown)	61-000207-01

**Note:** Additional cordsets and accessories are available in the Microscan Product Pricing Catalog.

**Note:** The QX Hawk C-Mount does not require an Ethernet crossover cordset, because the imager itself performs automatic internal crossover (transmit-to-receive switching). Microscan offers a standard straight-through (un-crossed) Ethernet cordset (61-000160-01 or -02).

**Important:** Do not attempt to power more than four imagers with a single power supply in a daisy chain configuration. Add a QX-1 and one power supply for every four additional imagers in the daisy chain.

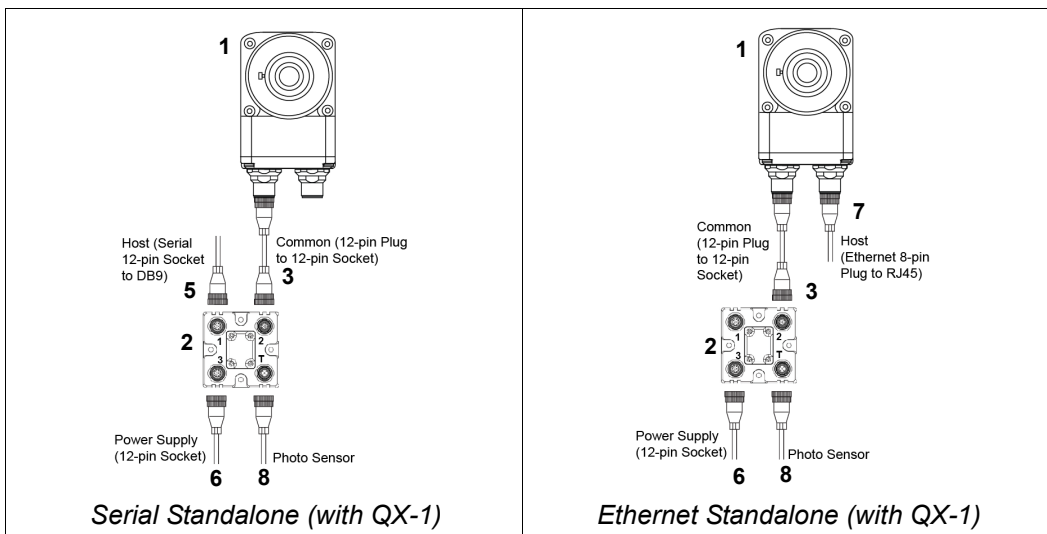

### Hardware Required

**Caution:** Be sure that all connections are secure **BEFORE** applying power to the system. Always power down **BEFORE** disconnecting any cables.

## Step 2 — Connect the System

### Standard QX Hawk

**Important:** When connecting Ultra-Lock cordsets to the QX Hawk and QX-1, align the pins first and then push the connector into place. Do not twist the connectors, as this will bend the pins.

**Important:** Do not attempt to power more than four imagers with a single power supply in a daisy chain configuration. Add a QX-1 and one power supply for every four additional imagers in the daisy chain.

#### RS-232

- Connect the Serial Communication Cable from “A” on the QX Hawk to “2” on the QX-1.
- Connect the host cable from “1” on the QX-1 to the host computer.
- Connect the photo sensor to “T” on the QX-1.
- Connect the power supply to “3” on the QX-1.
- Plug in the power supply.

#### Ethernet

**Note:** The QX Hawk does not require an Ethernet crossover cordset, because the imager itself performs automatic internal crossover (transmit-to-receive switching). Microscan offers a standard straight-through (un-crossed) Ethernet cordset (61-000160-01 or -02).

- Connect the Ethernet Cable from “B” on the QX Hawk to the network.
- Connect the photo sensor to “T” on the QX-1.
- Connect the power supply to “A” on the QX Hawk.
- Plug in the power supply.

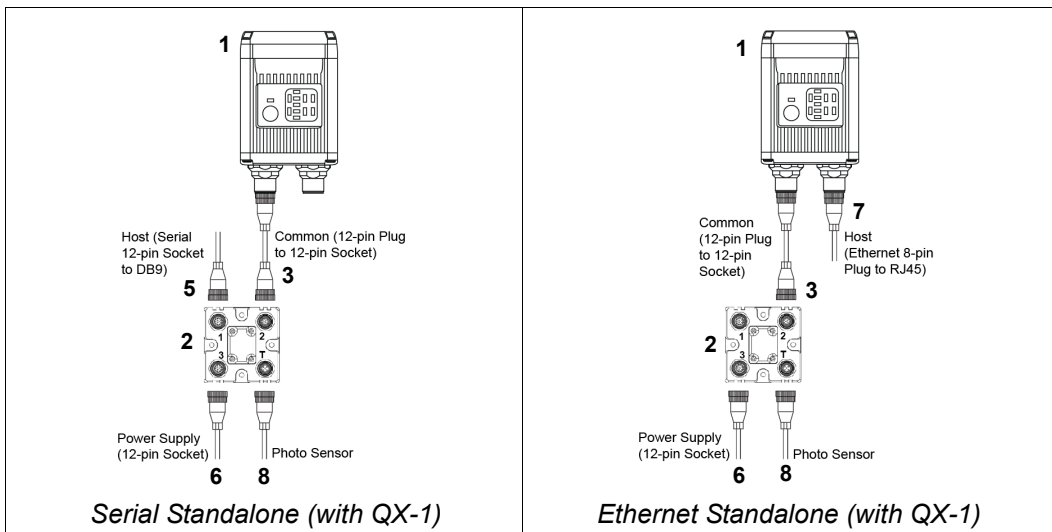



## QX Hawk C-Mount

**Important:** When connecting Ultra-Lock cordsets to the QX Hawk C-Mount and QX-1, align the pins first and then push the connector into place. Do not twist the connectors, as this will bend the pins.

**Important:** Do not attempt to power more than four imagers with a single power supply in a daisy chain configuration. Add a QX-1 and one power supply for every four additional imagers in the daisy chain.

### RS-232

- Connect the Serial Communication Cable from “A” on the QX Hawk C-Mount to “2” on the QX-1.
- Connect the host cable from “1” on the QX-1 to the host computer.
- Connect the photo sensor to “T” on the QX-1.
- Connect the power supply to “3” on the QX-1.
- Plug in the power supply.

### Ethernet

**Note:** The QX Hawk C-Mount does not require an Ethernet crossover cordset, because the imager itself performs automatic internal crossover (transmit-to-receive switching). Microscan offers a standard straight-through (un-crossed) Ethernet cordset (61-000160-01 or -02).

- Connect the Ethernet Cable from “B” on the QX Hawk C-Mount to the network.
- Connect the photo sensor to “T” on the QX-1.
- Connect the power supply to “A” on the QX Hawk C-Mount.
- Plug in the power supply.

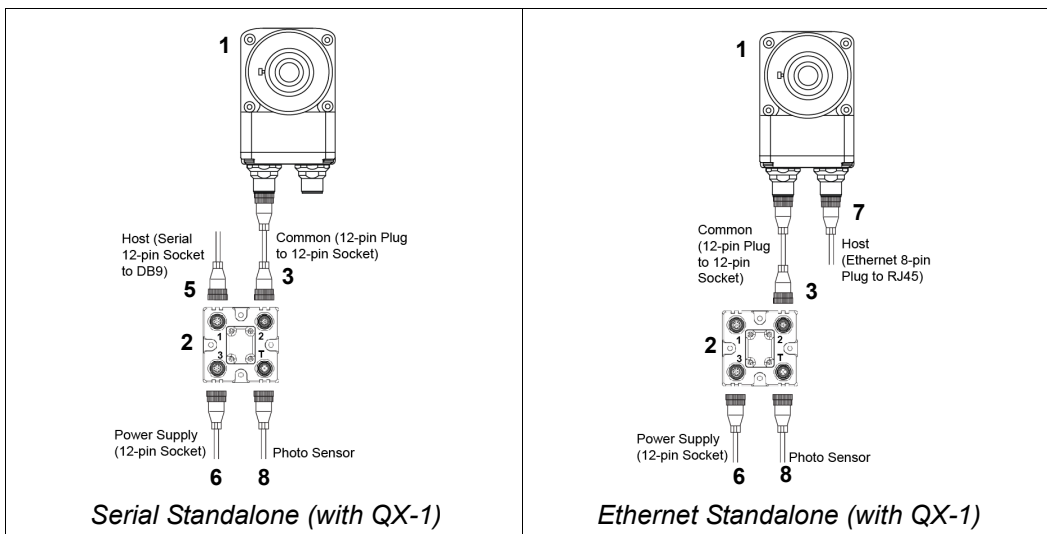

## Step 3 — Position the Imager

- Position the imager at a focal distance of one inch or more from a test symbol.
- Tip the imager relative to the symbol if necessary to avoid the glare of direct (specular) reflection.
- Symbols can be rotated (tilted) at any angle; however, for best results symbols should be aligned with the field of view. In the case of linear symbols, aligning the bars in the direction of their movement (ladder orientation) will minimize the chances of blurring and will result in more consistent decodes.

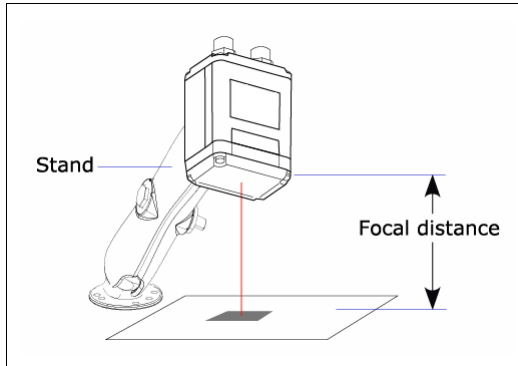

*Standard QX Hawk Imager and Symbol Orientation*

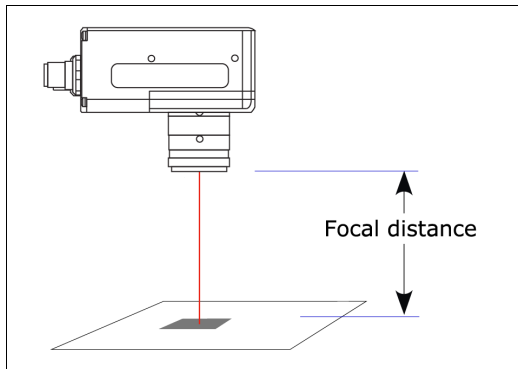

*QX Hawk C-Mount Imager and Symbol Orientation*

**Important:** Avoid excessive skew or pitch. Maximum skew is  $\pm 30^\circ$ ; maximum pitch is  $\pm 30^\circ$ .

## Step 4 — Install ESP

ESP Software can be found on the Microscan Tools Drive.

1. Follow the prompts to install ESP from the Tools Drive.
2. Click on the ESP icon to run the program.



**Note:** ESP can also be installed from the **Download Center** at [www.microscan.com](http://www.microscan.com).

### Minimum System Requirements

- 233 MHz Pentium PC
- Windows 8, 7, Vista, or XP operating system (32-bit or 64-bit)
- Internet Explorer 6.0 or higher
- 128 MB RAM or greater
- 160 MB free disk space
- 800 x 600 256 color display (1024 x 768 32-bit color recommended)

## Step 5 — Select Model

### Standard QX Hawk

When you start ESP, the model menu will appear:

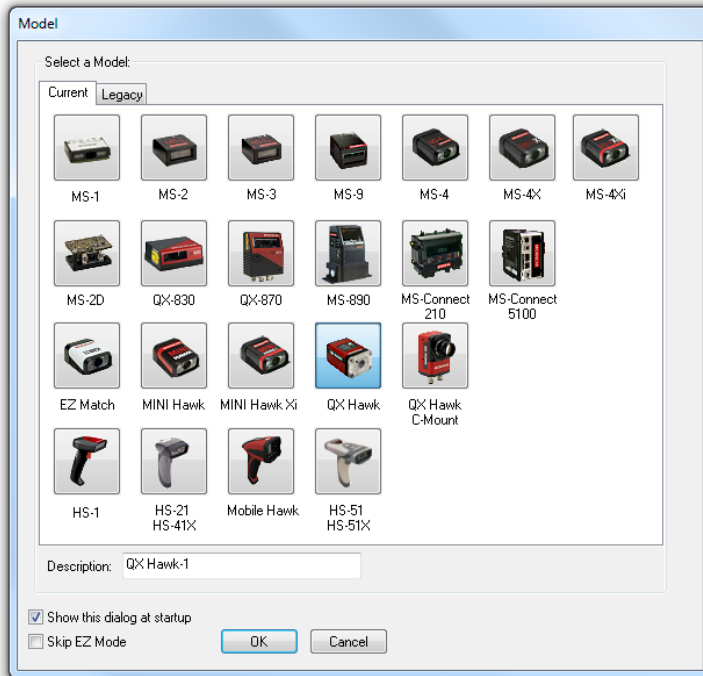

1. Click the button showing the QX Hawk.
2. Click **OK**.  
**Note:** You can also simply double-click the button showing your imager to make your selection.
3. Click **Yes** when the following dialog appears:

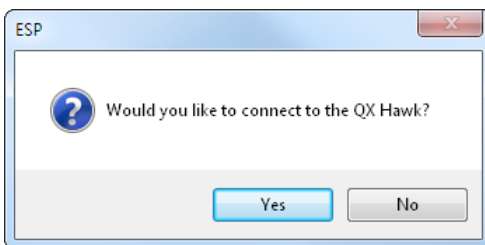

**Note:** If you need to select another model later, click the **Switch Model** button near the top of the screen or use **Model > New Model** in the menu toolbar.

## QX Hawk C-Mount

When you start **ESP**, the model menu will appear:

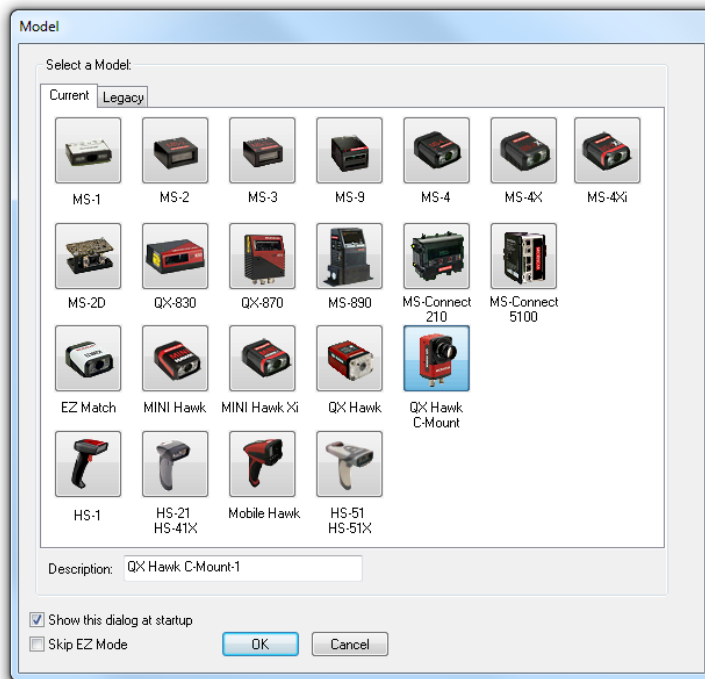

1. Click the button showing the QX Hawk C-Mount.
2. Click **OK**.

**Note:** You can also simply double-click the button showing your imager to make your selection.

3. Click **Yes** when the following dialog appears:

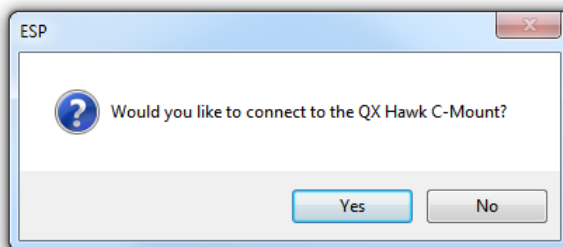

**Note:** If you need to select another model later, click the **Switch Model** button near the top of the screen or use **Model > New Model** in the menu toolbar.

## Step 6 — Connect

### Connection Wizard

To connect using the Connection Wizard:

- Click **Connect** on the menu toolbar, and then select **Connection Wizard**.
- Select **RS-232** or **Ethernet** to activate the appropriate display.
- Configure settings as required by the application, and click **Connect**.

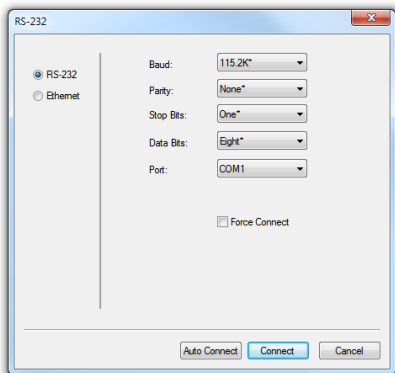

**RS-232 Connection Wizard**

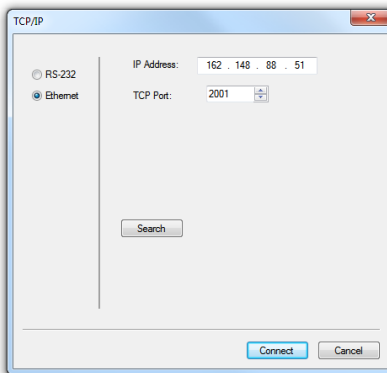

**Ethernet Connection Wizard**

- When a connection is established, the green indicator in the status bar at the bottom right of the screen will be visible:

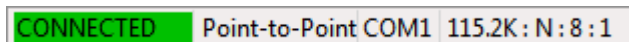

**Important:** The imager is in **Continuous Read Mode** by default. For best connection results, be sure that no decodable symbols are within the imager’s field of view while attempting to connect.

## Step 6 — Connect (cont.)

### Ethernet TCP/IP

Once the QX Hawk is connected, incoming symbol data can be displayed in the **Terminal**, as shown below.

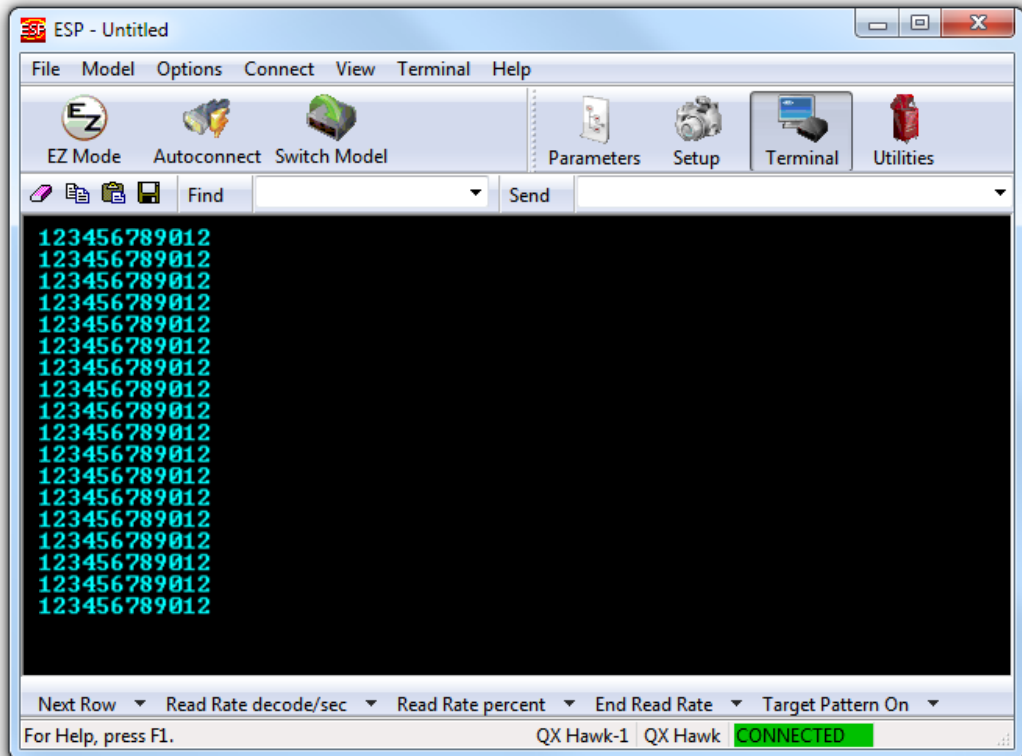

## Step 7 — Locate Symbol

### Locate by ESP

- In **ESP's EZ Mode**, click the **Locate** button to enable the red **X** pattern.

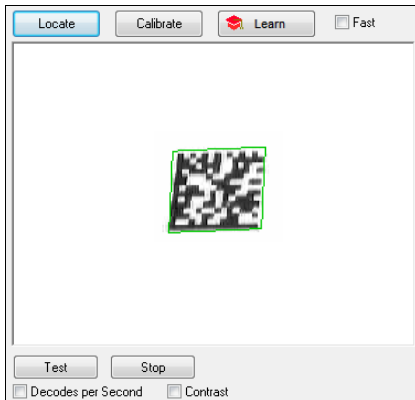

The symbol in the field of view will appear in the video view beneath the **Locate** and **Calibrate** buttons, and you will see the red target pattern projected from the front of the imager.

**Note:** The QX Hawk C-Mount does not display a target pattern.

- Center the target pattern on the symbol.

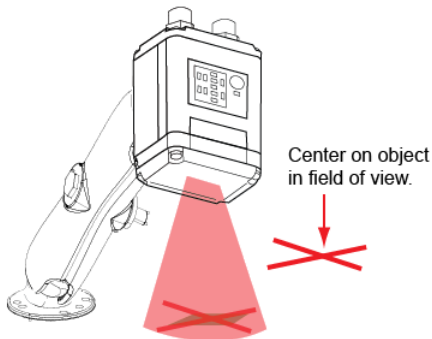

**Important:** The entire symbol should fall within the field of view (FOV) of the imager. The field of view is what appears in **ESP's Locate/Calibrate** window in **EZ Mode**.

- Click the **Stop** button to end the **Locate** function.





## Locate by EZ Button

If you are not connected to a host computer, the **EZ Button** allows you to locate a symbol in the imager's field of view.

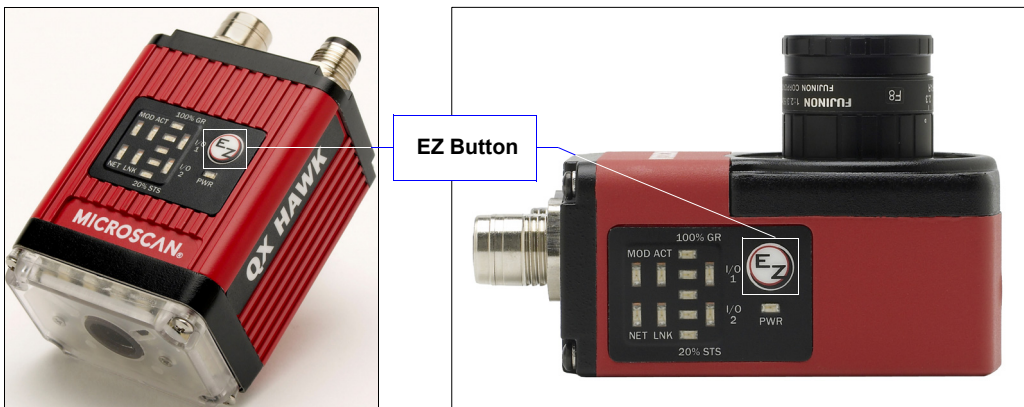

- Hold down the EZ Button for about one second and release when you hear one short beep. The amber **20%** LED will illuminate, and you will see the red target pattern projected from the front of the imager.
- Center the target pattern on the symbol.

**Note:** To end all EZ Button functions, press the EZ Button once and quickly release.

## Step 8 — Calibrate

Imager settings can be adjusted automatically for optimum performance by either the EZ Button or by **ESP**.

During the calibration routine, the imager will flash its amber Read Rate percent LEDs and illumination LEDs while searching camera settings and determining the best configuration for decoding symbol data. Upon successful completion of this routine, a green LED pattern will flash brightly and illuminate the symbol. If unsuccessful, the imager will emit 5 short beeps and stop searching.

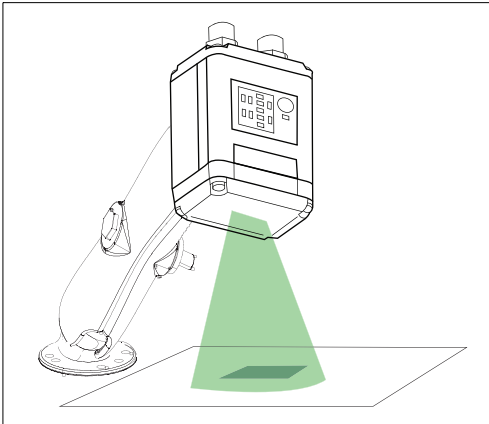

### Calibrate by ESP

1. Click the **Calibrate** button.



2. The imager will search camera settings to determine the best configuration for decoding symbol data.

A successful calibration will display a green frame around the symbol, and the following message will appear: "Uploading all reader parameters." After a moment the symbol data will be presented in the field below the image display window.

### Calibrate by EZ Button

1. Hold down the EZ Button for about two seconds and release when you hear **two short beeps**. The **20%** and **40%** LEDs will illuminate.
2. The imager will search camera settings to determine the best configuration for decoding symbol data.

**Note:** To end all EZ Button functions, press the EZ Button once and quickly release.

### Calibrate by Serial Command

Send **<@CAL>** from a terminal program to begin auto-calibration.

## Step 9 — Test Read Rate

**Read Rate** indicates the number of successful decodes per second achieved by the imager.

### Test Read Rate by ESP

1. Click the **Test** button to start the **Read Rate** test.

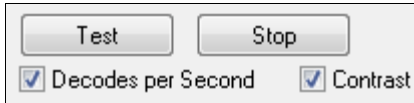

If a symbol has been successfully decoded, its data and related information will be presented in the field below the image display window. While the symbol is being decoded, the Read Rate LEDs will indicate the corresponding read rate percentage on the top of the unit.

2. Click the **Stop** button to end the Read Rate test.

**Note:** Read rate can also be tested using the **Read Rate** interface in **Utilities**.

### Test Read Rate by EZ Button

1. To start the Read Rate test, hold down the EZ Button about three seconds until you hear **three short beeps**. The **20%**, **40%**, and **60%** LEDs will illuminate.

While the symbol is being decoded, the Read Rate LEDs will indicate the corresponding read rate percentage on the top of the unit.

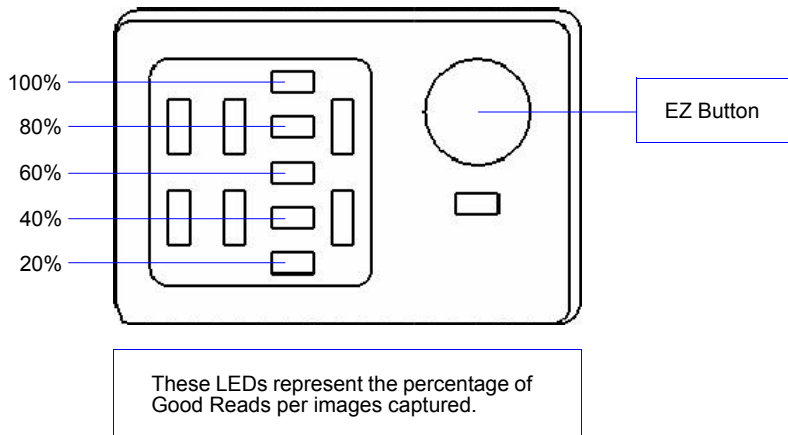

2. To end the Read Rate test, press the EZ Button and quickly release.

### Test Read Rate by Serial Command

You can also start a test with the **<C>** or **<Cp>** command and end it with the **<J>** command.

## Step 10 — Configure the Imager

Click the **App Mode** button to make configuration changes to the imager.

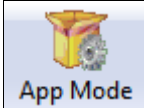

The following modes are accessible by clicking the buttons at the top of the screen:

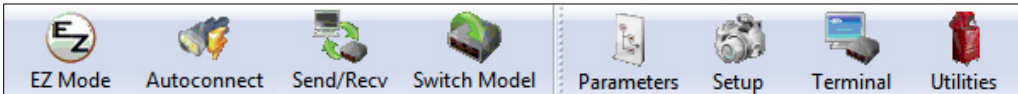

- Click the **EZ Mode** button to return to EZ Mode.
- Click the **Autoconnect** button to establish communication.
- Click the **Send/Recv** button to send or receive commands.
- Click the **Switch Model** button to open the model menu, or to return to a previous model.
- Click the **Parameters** button to show the tabbed tree controls for Communication, Read Cycle, Symbologies, I/O Parameters, Symbol Quality, Matchcode, and Diagnostics.
- Click the **Setup** button to access the Camera Setup tree control and the tabbed interfaces for Video, Evaluation, Calibration, Window of Interest (WOI), Configuration Database, Ordered Output, Output Format, and Dynamic Setup.
- Click the **Terminal** button to display decoded symbol data and to send serial commands to the imager using text or macros.
- Click the **Utilities** button to show the tabbed interfaces for Read Rate, Counters, Device Control, Differences from Default, Master Database, and Firmware.

For further details, see **ESP Help** in the dropdown Help menu.

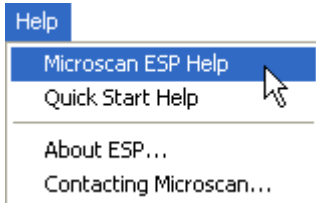

## Step 11 — Save Changes

To make changes to configuration settings in the tree controls:

Parameters	ESP Values
[-] Communications	
[+] RS232 A	
[+] RS232 B	Enabled
[+] RS422	Disabled
[+] Ethernet	Enabled
[+] Protocol Selection	Point-to-Point
[+] External Data Routing	Disabled
[+] Array Communication Modes	Disabled
[-] Preamble	Disabled*
... Preamble Characters	Disabled*
[+] Postamble	Enabled

1. **Left-click** on the **+** to expand the desired tree.
2. **Double-click** on the desired parameter and click once in the selection box to view options.
3. Place the cursor in the selection box, scroll down to the setting you want to change, and **click** once on the setting.
4. **Left-click** again on the open screen to complete the selection.
5. **Right-click** on the open screen and select **Save to Reader** to implement the command in the imager.

### Saving Options

- **Send, No Save.** Changes will be lost when power is re-applied to the imager.
- **Send and Save.** This activates all changes in current memory *and* saves to the imager for power-on.

---

*Save Changes*

# 2 Using ESP

## Contents

EZ Mode.....	2-2
App Mode.....	2-3
Menu Toolbar.....	2-4
Navigating in ESP.....	2-15
Send/Receive Options.....	2-16

This section explains the basic structure and elements of **ESP** (Easy Setup Program). When **ESP** is opened, unless otherwise specified in **ESP Preferences**, the **EZ Mode** view will appear. **App Mode** contains several tree controls (**Communication**, **Read Cycle**, **Symbologies**, **I/O Parameters**, **Symbol Quality**, **Matchcode**, and **Diagnostics**), a **Setup** interface, a **Terminal** interface, and a **Utilities** interface.

**ESP** can be used to configure the QX Hawk in three different ways:

- **Graphic User Interfaces:** Imager settings can be configured using such point-and-click tools as buttons, spin boxes, check boxes, and drag-and-drop functions.
- **Tree Controls:** Each tree control contains a list of all command settings that pertain to that specific area of imager operation. Each parameter can be configured using dropdown menus or fields where characters can be entered.
- **Terminal:** **ESP**'s **Terminal** allows the user to send serial configuration and utility commands directly to the imager by typing them in the provided field.

Information about using specific commands in **ESP** is provided in subsequent sections.

For **ESP** system requirements, see [Minimum System Requirements](#) in Chapter 1, [Quick Start](#).

# EZ Mode

**EZ Mode** allows the user to test read rate and calibrate the imager. After connecting to the imager, the **EZ Mode** view will appear. On-screen instructions assist the user with positioning, testing, and calibration.

## Locate/Calibrate/Learn

The calibration routine optimizes the imager by comparing Read Rates at various camera and image processing settings. Click **Locate** to find the symbol in the field of view and display it in the video view. Then click **Calibrate** to begin the calibration routine. The **Learn** button allows you to save information about the next Data Matrix symbol decoded, which allows faster and more consistent processing of subsequent identical symbols.

## Test

Click the **Test** button to start the Read Rate test for a quick indication of the imager's read capabilities and the limits of the application. When **Decodes per Second** is unchecked, the test will count the percentage of decodes relative to the number of actual scans. Click **Stop** to end the test.

The screenshot shows the 'ESP - Untitled' software window. The menu bar includes File, Model, Options, Connect, and Help. Below the menu bar are icons for App Mode, Autoconnect, and Switch Model. The main window is titled 'Welcome to Easy Setup Program' and contains the following instructions:

1. First, position the imager at the desired Focal Distance.  
*Note: To avoid glare, set the angle of the reader about 15 degrees relative to the symbol.*
2. Click **Locate** to begin.

Callout boxes provide additional instructions:

- Click the **App Mode** button to access configuration trees and other setup features.
- Click **Locate** to find and display the symbol. Click **Calibrate** to begin the calibration routine. Calibration is also explained in **Quick Start**. Click **Learn** to save information about the next Data Matrix symbol decoded.
- Click **Test** button to start the Read Rate test and click **Stop** to end the test.
- Click here to initiate a sliding focus control.
- When **Decodes per Second** is checked, the read rate test displays how many decodes the imager achieves each second, instead of displaying a percentage.
- Symbol data is displayed here.
- Contrast** brightens the image.

The interface includes buttons for Locate, Calibrate, Learn, Test, and Stop. A 'Fast' checkbox is also present. A video view shows a Data Matrix symbol. A 'Test' section contains checkboxes for 'Decodes per Second' and 'Contrast', and a 'Test' button. A 'Focus' control is shown with a 'Fast' checkbox and a 'Test' button. A table for 'Attribute' and 'Value' is visible at the bottom.



# App Mode

From **EZ Mode**, click on the **App Mode** button to access the tabbed tree controls in **Parameters**, the intuitive user interfaces in **Setup**, the **Terminal** interface, and the **Utilities** interface.

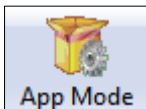

**Note:** The **App Mode** and **EZ Mode** buttons appear in the same position to allow easy switching between these primary modes.

Video, Evaluation, Calibration, WOI, Configuration Database, Ordered Output, Output Format, Dynamic Setup

Click this icon to return to **EZ Mode**.

Menu toolbar

Click here to open the **Terminal** view.

Read Rate, Counters, Device Control, Differences from Default, Master Database, Firmware

ESP - Untitled

File Model Options Connect View Help

EZ Mode Autoconnect Send/Recv Switch Model Parameters Setup Terminal Utilities

Communication Read Cycle Symbologies I/O Symbol Quality Matchcode Diagnostics

Parameters ESP Values

Read Cycle

- Multisymbol
- Trigger
- Serial Trigger
- Decodes Before Output
- End of Read Cycle
- Capture Mode
- Capture Time
- Store No Read Image
- Image Processing Settings

**Autoconnect to the imager, Send and Receive command settings, and Switch Model.**

Tabbed tree controls

**Mirror Image** reverses the image. **Contrast** brightens the image.

Click **Capture and Decode** to decode the symbol in the field of view, and to see a high resolution image capture of the symbol.

Capture and Decode  Mirror Image  Contrast

Symbol data is displayed here.

Attribute	Value

For Help, press F1. QX Hawk-1 QX Hawk CONNECTED Point-to-Point COM1 115.2

# Menu Toolbar

## File

### New

Whenever **New** is selected, the default configuration of **ESP** is loaded.

### Open/Save

When **Save** or **Save As** is selected, the **ESP** configuration is saved to the host computer's hard drive and available whenever the same file is selected under **Open**.

**Important:** When configuration changes are saved to the hard drive, these changes are not automatically saved to the imager. The illustration below shows how settings can be saved and received between **ESP** and the imager, and **ESP** and the host hard drive.

File	
New	Ctrl+N
Open...	Ctrl+O
Save	Ctrl+S
Save As...	
Print...	Ctrl+P
Import...	
Export...	
Recent File	
Exit	

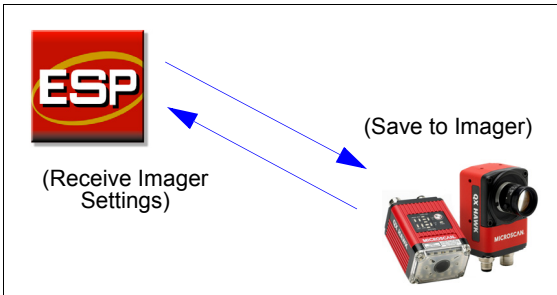

### Import/Export

**Import** converts the ASCII settings from a text file to **ESP** configuration settings.

**Export** converts the active **ESP** configuration settings to an ASCII text file.

## Model

The **Model** dropdown menu shows a list of recent imagers that have been used with ESP. When a different model is chosen, the connection to the present model is terminated.

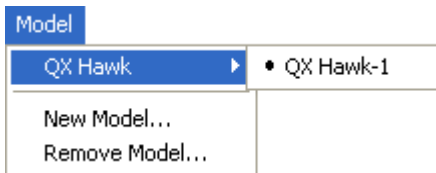

To connect to another model, select **New Model**, choose a new model from the **pop-up menu** that appears, and click **OK**.

**Note:** When an **ESP** file is saved, the settings of all the models defined in that file are saved.

## Options

The **Options** menu allows the user to save memos and set up **ESP Preferences**.

**Note:** Preferences will be saved and loaded into **ESP** whenever **ESP** is opened next, whether or not the **ESP** file is saved.

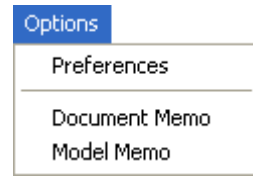

## Preferences > General Tab

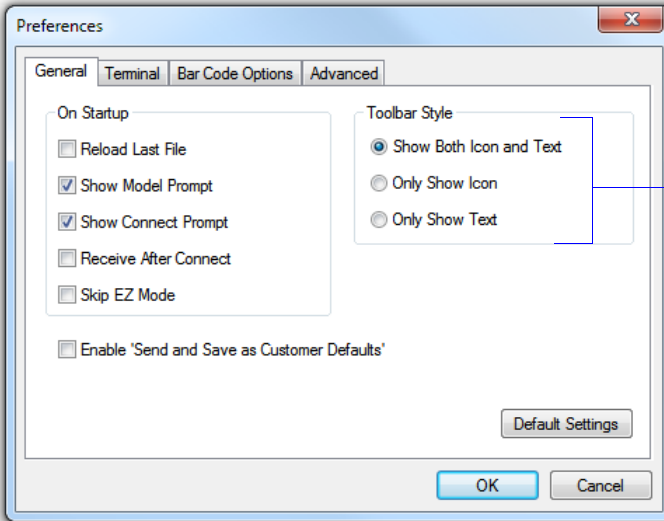

The **Toolbar Style** options allow the user to determine how **ESP** will display the mode options in the two rows at the top of the screen.

### **Reload Last File**

At startup, reloads the last file saved to the host computer's hard drive.

### **Show Model Prompt**

At startup, shows the model menu displaying all supported readers.

### **Show Connect Prompt**

At startup, displays the **Would you like to connect to the QX Hawk?** prompt.

### **Receive After Connect**

At startup, loads the imager's settings into **ESP**. (This is not recommended if **ESP** settings are needed for future use.)

### **Skip EZ Mode**

At startup, skips **EZ Mode** and opens directly in **App Mode**.

### **Enable 'Send and Save as Customer Defaults'**

At startup, enables the **Send and Save as Customer Defaults** option in the **Send/Recv** command.

## Preferences > Terminal Tab

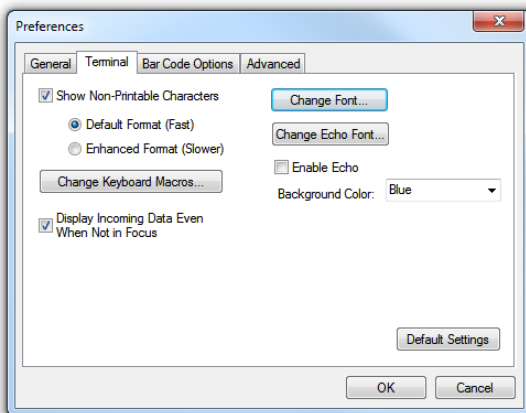

### Show Non-Printable Characters

When **Show Non-Printable Characters** is enabled, characters such as “CRLF” will be displayed in the Terminal window. When **Enhanced Format** is checked, the characters are displayed with more detailed formatting.

### Change Keyboard Macros

Clicking the **Change Keyboard Macros** button brings up the **Function Keys** dialog. In this dialog, select the desired function key and then enter the macro keystrokes in the associated key map. For example, to make **Ctrl-F2** the keystroke to send a trigger character, select **F2**, then in the **Ctrl** row, enter **<trigger character>** and click **OK**. Then whenever the **Ctrl-F2** keystroke is pressed, the trigger character will start the read cycle.

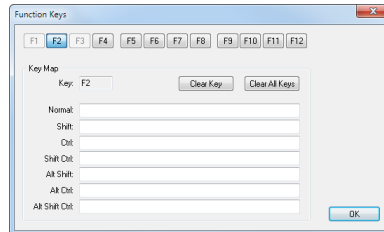

**Note:** The **F1** key is reserved for opening **ESP Help** and the **F3** key is reserved for the **Find Next** function.

### Change Font

Allows the user to modify the font used for decode data received from the imager on the Terminal.

### Change Echo Font

Allows the user to modify the font used for command characters typed into the Terminal.

### Enable Echo

Allows the user to enter command characters in Terminal.

### Display Incoming Data Even When Not in Focus

When **Display Incoming Data Even When Not in Focus** is enabled, data from the imager will continue to appear in the Terminal even when **ESP** is not the top window.

## Preferences > Bar Code Options Tab

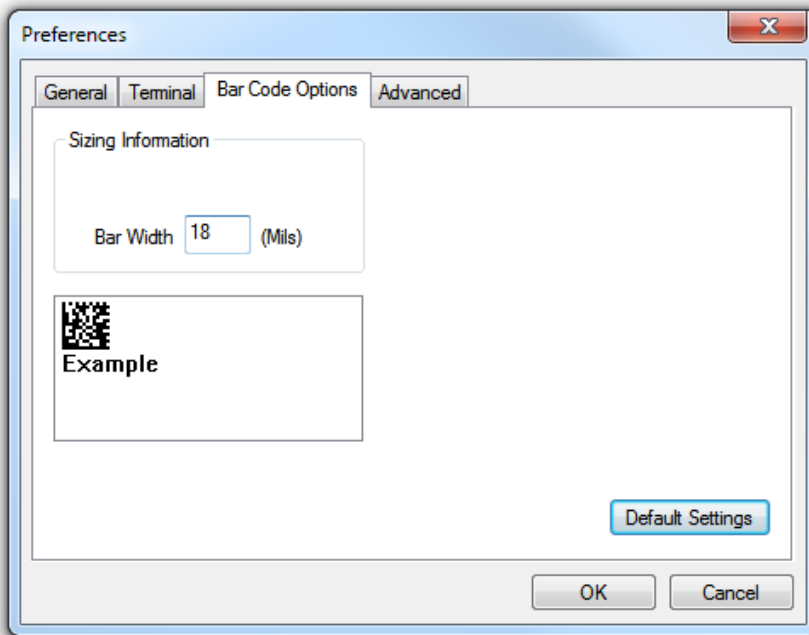

### **Sizing Information**

Sets the bar height (in inches) and bar width (in **mils**, or thousandths of an inch) of user-created symbols.

*Example:* A bar width of 18 mils is 0.018 inches.

## Preferences > Advanced Tab

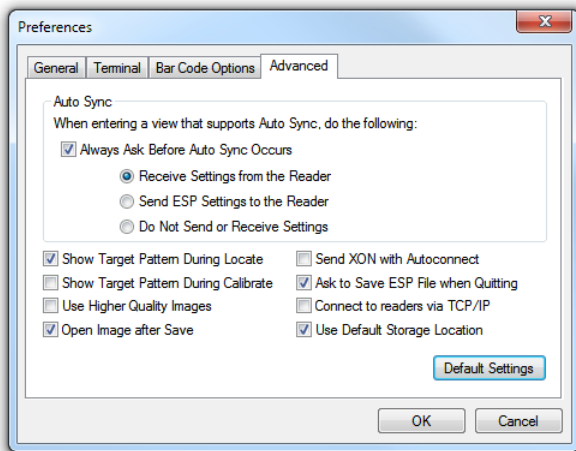

The **Auto Sync** options at the top of the **Advanced** tab allow the user to determine whether Auto Sync will be enabled automatically in sections of **ESP** where it is used, or if it will ask before it enables Auto Sync functions.

### ***Always Ask Before Auto Sync Occurs***

If this option box is checked, specific Auto Sync functions can be enabled. **Receive Settings from the Reader** will automatically send the imager's settings to **ESP** when Auto Sync is enabled. **Send ESP Settings to the Reader** will automatically send all imager configuration settings chosen in **ESP** to the imager. **Do Not Send or Receive Settings** creates a condition in which Auto Sync will not automatically send imager settings to **ESP**, or send **ESP** settings to the imager.

### ***Show Target Pattern During Locate***

Allows you to determine whether the blue LED target pattern will be on or off during the **Locate** routine.

### ***Show Target Pattern During Calibrate***

Allows you to determine whether the blue LED target pattern will be on or off during the **Calibrate** routine.

### ***Use Higher Quality Images***

Sets **ESP** to output images at a higher resolution than standard JPEG format.

### ***Open Image after Save***

When **Open Image after Save** is enabled, **ESP** automatically opens saved image captures. Images can be saved from the **Evaluation** tab in the **Camera** view, or by right clicking an image in any other image capture view and then saving.

### ***Send XON with Autoconnect***

Sends an **XON (Begin Transmission)** command to the imager before starting the **Autoconnect** routine.

## Preferences > Advanced Tab (cont.)

### **Ask to Save ESP File when Quitting**

When enabled, prompts the user to save a **.esp** file when ending a session.

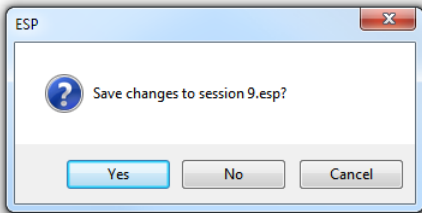

The **.esp** file will be saved in the location specified by the user.

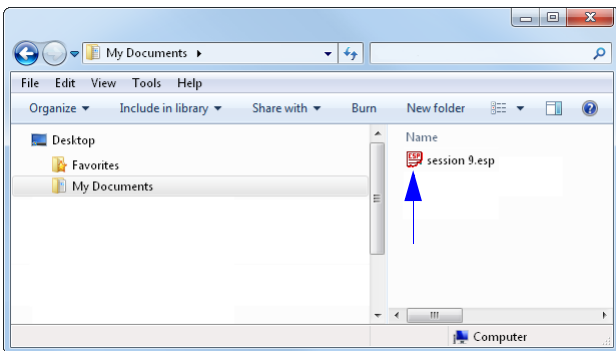

### **Connect to Readers via TCP/IP**

When enabled, shows the **TCP/IP Connection Wizard** by default.

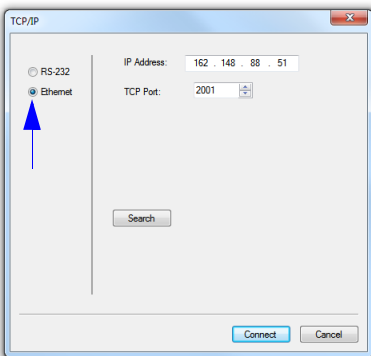

### **Use Default Storage Location**

When enabled, automatically stores data in **ESP's** Application Data folder.



## Document Memo

The information entered in the **Document Memo** field will appear in a context-sensitive text box whenever the cursor hovers over the **Document Memo** item on the **Options** menu.

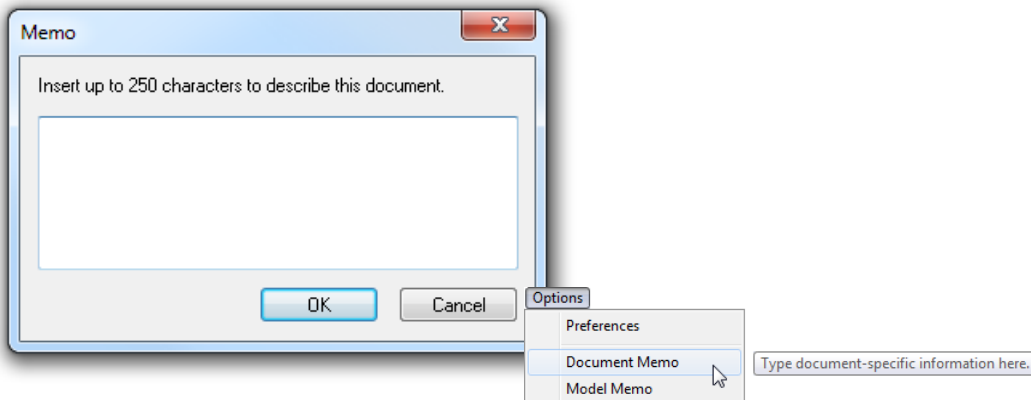

## Model Memo

Similar to **Document Memo**, the information entered in the **Model Memo** field will appear in a context-sensitive text box whenever the cursor hovers over the **Model Memo** item on the **Options** menu. Memos created in **Model Memo** are specific to the model enabled when the message was created.

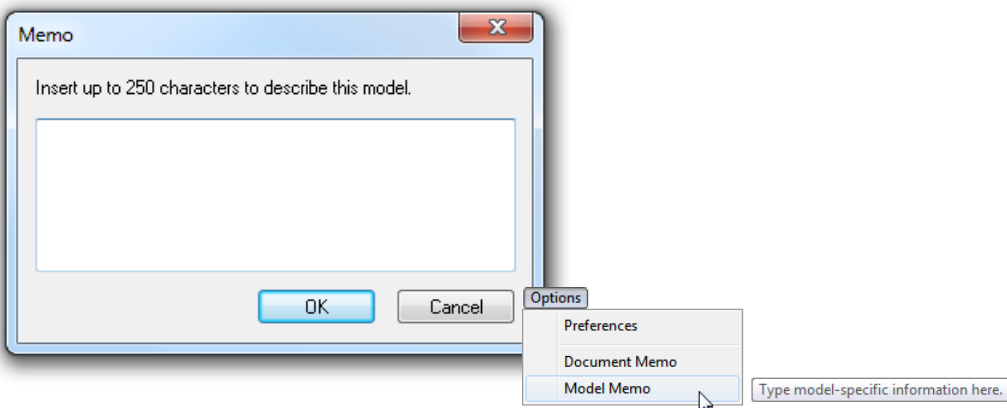

**Note:** Memos must be saved in a **.esp** file to make them available in the next session. If the current session is not saved, any memos that have been entered during the session will be discarded, and will be unavailable in the next session.

## Connect

The **Connect** dropdown menu allows the user to access the **Connection Wizard**, as well as the **Autoconnect** and **Configure Multidrop** dialogs. **Connect** and **Disconnect** can also be performed directly from the dropdown menu without opening a dialog.

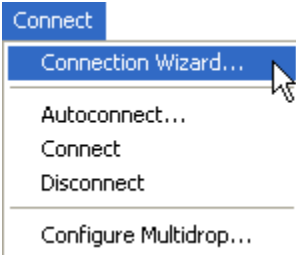

## Connection Wizard

To connect using the **Connection Wizard**:

- Click **Connect** on **ESP**'s menu toolbar, and then select **Connection Wizard**.
- Select **RS-232** or **Ethernet** to activate the appropriate display.
- Configure RS-232 or Ethernet settings as required by the application, and click **Connect**.

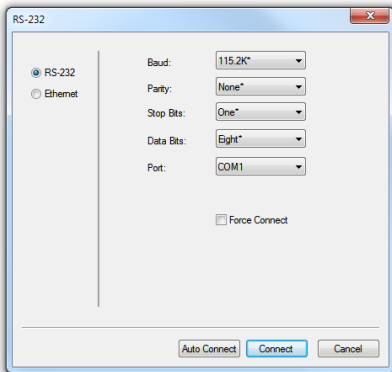

**RS-232 Connection Wizard**

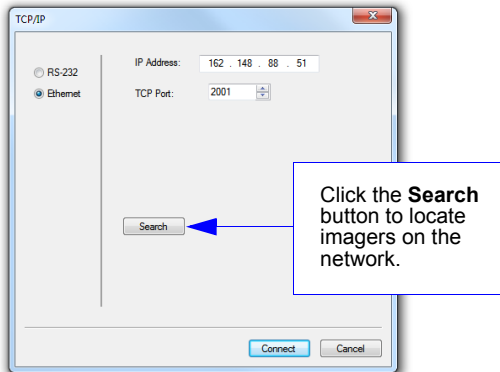

**Ethernet Connection Wizard**

- When a connection is established, the green indicator in the status bar at the bottom right of the screen will be visible.

## Autoconnect

- If the RS-232 connection attempt fails, use **Autoconnect** to establish a connection between the imager and the host.

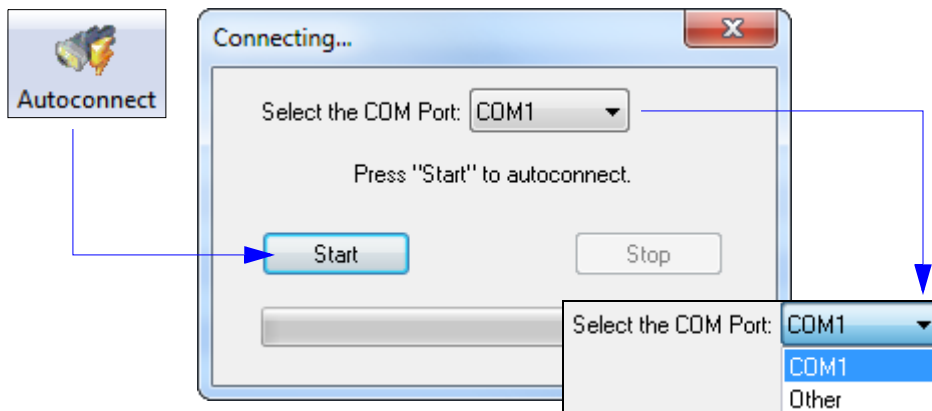

- If the communication port is not the default **COM1**, use the dropdown menu to change the port.

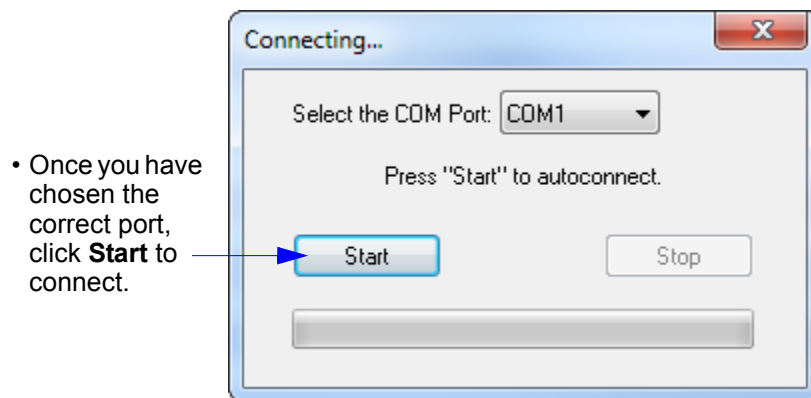

- When a connection is established, the green indicator in the status bar at the bottom right of the screen will be visible.

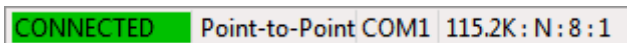

## View

The **View** menu allows the user to move quickly between the **Parameters**, **Setup**, **Terminal**, and **Utilities** interfaces without using the icon buttons on the **App Mode** toolbar. It also allows the user to access the **Bar Code Dialog**, shown below.

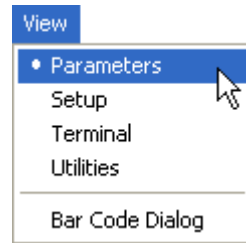

## Bar Code Dialog

Symbols can be created in the **Bar Code Dialog** by typing the text to be encoded. This is a useful tool for creating configuration symbols, allowing the user to configure the imager by reading the user-created symbols.

A screenshot of the "Bar Code Configuration" dialog box. The dialog has a title bar with "Bar Code Configuration" and a close button. It contains several sections: "Print..." and "Save As..." buttons; a "Bar Code Value" field with left and right arrow buttons; a "Rotation" dropdown menu set to "0 Degrees" with a "New" button; a "Caption" section with radio buttons for "Same As Bar Code Value" (selected) and "Specify" (with an empty text field); checkboxes for "Add start configuration code" and "Add end configuration code; Save Settings"; a "Differences from Default Settings" button; and a preview area at the bottom showing a barcode symbol with left and right arrow buttons. Four callout boxes with blue borders and arrows point to specific elements: 1. "Choose a spatial orientation for the new symbol." points to the "Rotation" dropdown. 2. "Drag specific configuration values from the control tree directly into this field to encode new symbols." points to the "Bar Code Value" field. 3. "Create a caption for the symbol that matches or describes the encoded data." points to the "Specify" radio button and its text field. 4. "The symbol will be displayed in the field at the bottom of the Bar Code Dialog." points to the preview area.

# Navigating in ESP

To change imager settings, or to access the **Setup**, **Terminal**, or **Utilities** views, click the **App Mode** button.

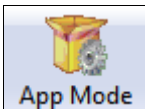

To return to **EZ Mode**, click the **EZ Mode** button.

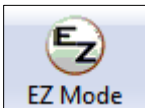

**To make changes to configuration settings in the tree controls:**

1. **Left-click** on the + to expand menu items.
2. **Double-click** the desired parameter and **single-click** in the selection box to view options.
3. Place the cursor in the selection box, scroll down to the desired setting, and **single-click** the setting.

Parameters	ESP Values
[-] Communications	
[-] R5232 A	Enabled
[-] R5232 B	Enabled
[-] R5422	Disabled
[-] Ethernet	Enabled
[-] Protocol Selection	Point-to-Point
[-] External Data Routing	Disabled
[-] Array Communication Modes	Disabled
[-] Preamble	Disabled*
[-] Preamble Characters	Disabled*
[-] Postamble	Enabled

The X indicates that the setting is default.

4. **Left-click** again on the open screen to complete the selection.
5. **Right-click** on the open screen and select **Save to Reader** to implement the command in the imager. The command can be sent without saving, or sent and saved simultaneously.

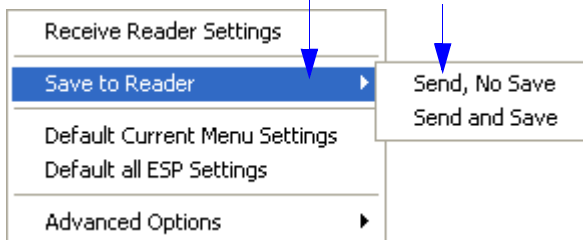

## Send/Receive Options

To access **Receive**, **Save**, and **Default** options, click the **Send/Recv** button. These options can also be reached by right-clicking in any of the configuration views.



### Receiving

From the **Send/Recv** menu, select **Receive Reader Settings**.

**Caution:** Selecting this option will upload the imager's settings. If the **ESP** file has a number of custom settings that must be maintained and downloaded into the imager, these settings will be lost.

This function is useful for receiving (uploading) the imager's settings and saving them as a file for future use. For example, if the imager has settings that must not change, **Receive Reader Settings** would load those settings to **ESP** and save them in an **ESP** file for later retrieval.

Receiving the imager's settings will also assure that any unwanted subsequent changes in **ESP** will not be saved.

### Saving

#### Send, No Save (<A>)

Saves **ESP** settings to current memory.

#### Send and Save (<Z>)

Activates all changes in current memory *and* saves to the imager for power-on.

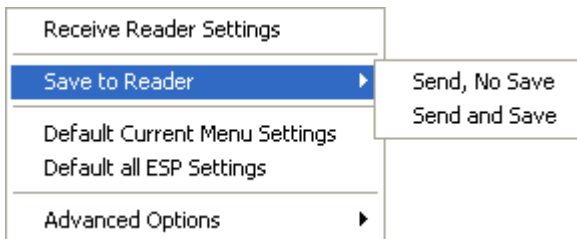

#### Send and Save as Customer Defaults (<Zc>)

Saves default settings for quick retrieval.

This option will be visible only if **Enable 'Send and Save as Customer Defaults'** is checked in **ESP Preferences**.

## Defaulting

When **Default Current Menu Settings** or **Default all ESP Settings** are selected, only the **ESP** settings are defaulted.

## Advanced Options

### Send Current View

This is the same as **Save to Reader** > **Send No Save** except that only the commands in the current configuration tree are sent.

### Send Current Command

This is the same as **Send Current View**, except that it saves only the command that is currently selected.

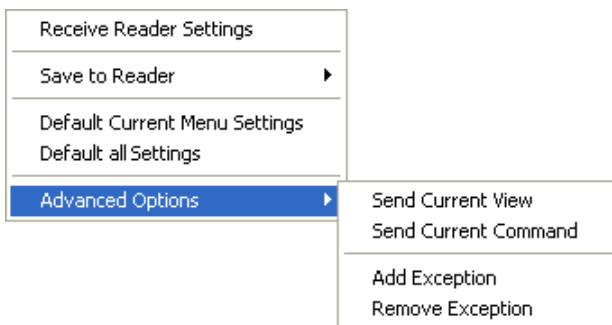

### Add/Remove Exception

After a **Receive Reader Settings** command is performed<sup>1</sup> and the **Add Exception** option is selected, a list of serial commands may appear. These are commands that may be in the imager's firmware, but are not included in, or are different from, the current version of **ESP**.

These commands can be edited by double-clicking them and changing them as needed.

It is important to note that these commands will be saved to the imager whenever a **Save to Reader** command is sent, or when an **<A>** or a **<Z>** command is sent.

Also, if there is a corresponding **ESP** menu item, the **ESP Value** column for that item will be blank following a **Receive Reader Settings** command.

1. From the **Send/Recv** button or by right-clicking in any blank section of a tree control view.





# ■ **3 *Hardware Integration***

## **Contents**

Cordsets .....	3-2
QX Hawk and QX-1 Connectors and Pinouts.....	3-3
Power and Trigger Switching.....	3-8
Port Routing.....	3-9
Application Examples .....	3-10

This section introduces the details of QX Hawk hardware, and explains how that hardware can be integrated in an application.

# Cordsets

The terms “cordset” and “cable” are both applicable to industrial connectivity, but they are not synonymous. Cordsets enable communications and power between imagers and interface devices. Cordsets have an M12 connector at one or both ends. Examples of cordsets are shown below.

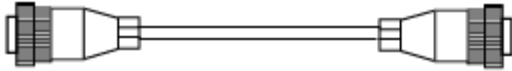

**M12 to M12 Cordset**

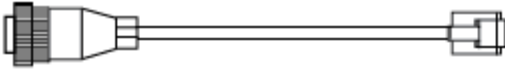

**M12 to RJ45 (Ethernet) Cordset**

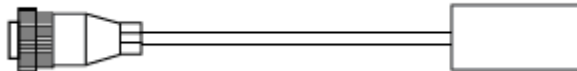

**M12 to Photo Sensor Cordset**

Cables do not have M12 connectors at either end. An example of a cable is shown below.

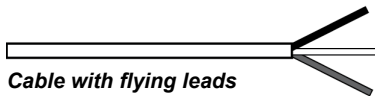

**Cable with flying leads**

## QX Hawk and QX-1 Connectors and Pinouts

When deploying a network of imagers and interface devices in an industrial setting, it is important to use components whose pin assignments are arranged in a way that avoids communication errors and equipment damage. This can be achieved with components that are designed in a logical, consistent, and easy-to-implement way.

The QX Hawk has a very simple pin assignment methodology. The clearly identified connectors at the back of the unit can be used to receive and bus power, and also to send and receive data and commands.

### QX Hawk Connectors



**A** is a serial M12 12-pin plug. It is the same for all models of the QX Hawk.

**B** is a serial M12 12-pin socket for serial models and an Ethernet M12 8-pin socket for Ethernet models.

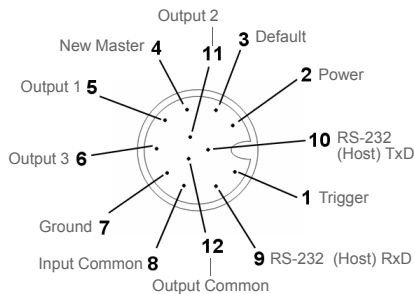

### A (All Models) M12 12-pin Plug

Pin	Function	Wire Color
1	Trigger	White
2	Power	Brown
3	Default	Green
4	New Master	Yellow
5	Output 1	Gray
6	Output 3	Pink
7	Ground	Blue
8	Input Common	Red
9	RS-232 (Host) RxD	Black
10	RS-232 (Host) TxD	Violet
11	Output 2	Gray/Pink
12	Output Common	Red/Blue

Continued next page

## QX Hawk and QX-1 Connectors and Pinouts (continued)

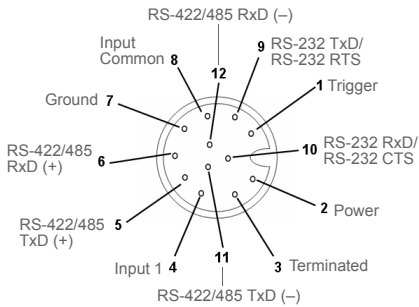

**B (Serial) M12 12-pin Socket**

Pin	Function	Wire Color
1	Trigger	White
2	Power	Brown
3	Terminated	Green
4	Input 1	Yellow
5	Port 3 422/485 TxD (+)	Gray
6	Port 3 422/485 RxD (+)	Pink
7	Ground	Blue
8	Input Common	Red
9	Port 2 TxD/Port 1 RTS	Black
10	Port 2 RxD/Port 1 CTS	Violet
11	Port 3 422/485 TxD (-)	Gray/Pink
12	Port 3 422/485 RxD (-)	Red/Blue

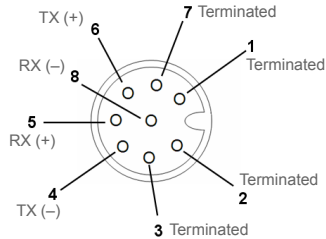

**B (Ethernet) M12 8-pin Socket**

Pin	Function
1	Terminated
2	Terminated
3	Terminated
4	TX (-)
5	RX (+)
6	TX (+)
7	Terminated
8	RX (-)

## Grounding the QX Hawk

Proper grounding is necessary for operator safety, noise reduction, and the protection of equipment from voltage transients. Buildings, including any steelwork, all circuits, and all junction boxes must be grounded directly to an earth ground in compliance with local and national electrical codes.

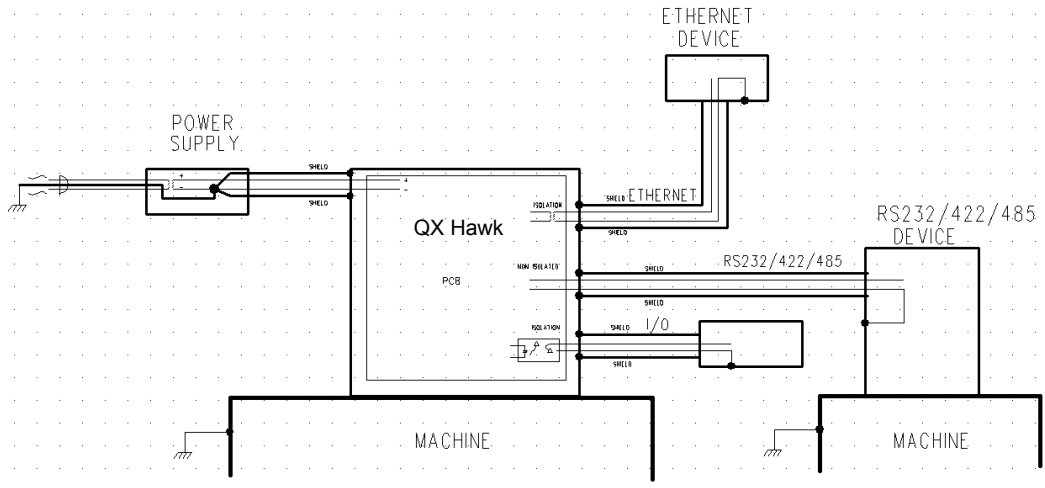

*An earth ground is provided through the cable shields and chassis of the imager.*

## Ground Loops

Ground loops (signal degradation due to different ground potentials in communicating devices) can be eliminated or minimized by ensuring that both the host, imager, and their power supplies are connected to a common earth ground.

## Expected Power and Ground Connections for Proper Operation

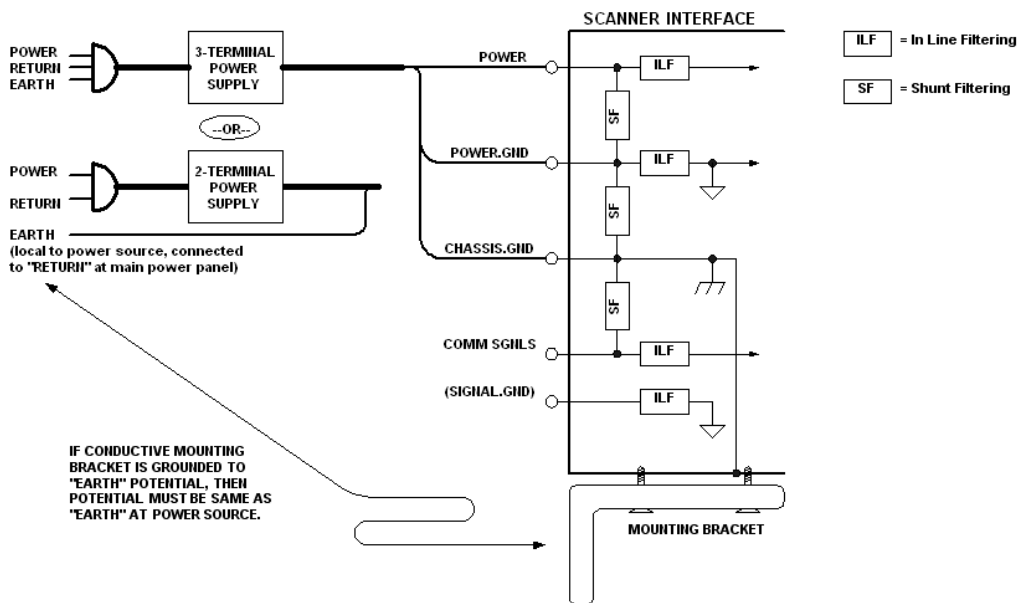

### Grounding Notes:

- Ensure that mounting bracket "Earth" is at the same potential as power source "Earth".
- Supply "Return" and "Earth" ground must be stable, low-impedance reference points.
- "2-Terminal Power Supply" must still provide an "Earth" connection to the imager.
- "Signal Ground" can be used for communications and/or discrete signal ground reference. It must **not** be used as Power Ground or Earth Ground.

## QX-1 Interface Device

The QX-1 Interface Device's receptacles are physically the same as those on the QX Hawk, but they do not have explicit pin assignments. The QX-1 allows users to bus power and communications as required by the application.

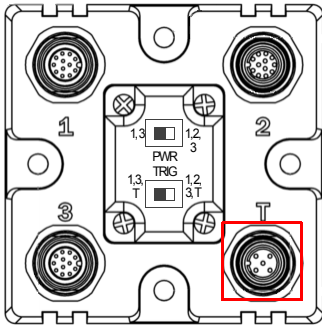

**QX-1 Interface Device**

**Connectors 1 and 3** are 12-pin plugs, and **Connector 2** is a 12-pin socket. All three connectors can be assigned to bus power and data as required by the application.

The two switches at the center of the device allow the user to route signals as needed.

Pin	Assignment
1	+ 10-28V
2	Trig/NM/Input 1 Common
3	Ground
4	Trigger

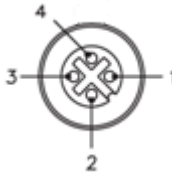

**QX-1 Trigger Connector 4-pin Socket**

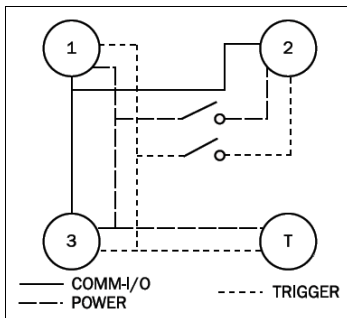

**QX-1 Communications - I/O -  
Power - Trigger**

This simple diagram (shown on the base of the QX-1) illustrates how power, communications, I/O, and trigger signal can be routed through the QX-1 device depending on the needs of the application. The switches greatly increase signal routing flexibility.

# Power and Trigger Switching

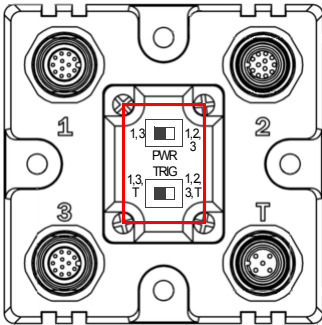

**Power** can be bussed between imagers and interface devices. At each location on a network where a new power supply is added, the Power switch on the QX-1 can be used to break power between Connector 2 and Connectors 1, 3, and T.

The **Trigger** signal between Connector 2 and Connectors 1, 3, and T can be broken using the Trigger switch. This isolates trigger signals as required by the application.

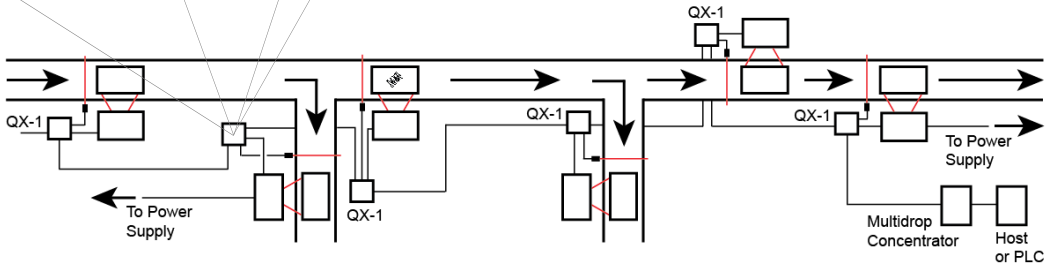



# Port Routing

The physical advantages created by flexible signal routing and switching are enhanced further by **Port Routing**, which can be configured in **ESP**. Port Routing eliminates the need for dedicated “Host” and “Aux” ports in a traditional sense. With Port Routing, any port can be defined as a Host or Aux port. Port Routing also allows users to define the data types that are accessible from specific ports.

The primary benefit of Port Routing is that any type of data can be routed to any port, and can be sent through multiple ports simultaneously. Multiple types of data can also be appended to the symbol data that is output from the imager to the host. Command data, symbol data, extended data, and diagnostic data are enabled by default in the QX Hawk.

The table below lists different types of data, with examples for each data type.

Data Type	Example
Command Data	Serial commands; imager responses to serial commands.
Symbol Data	Any string of data encoded in a symbol.
Extended Data	Decodes per trigger, decode direction, configuration database index number.
Diagnostic Data	Service message.

The screen capture below (from ESP) shows the QX Hawk’s four communications ports and the parameters for each.

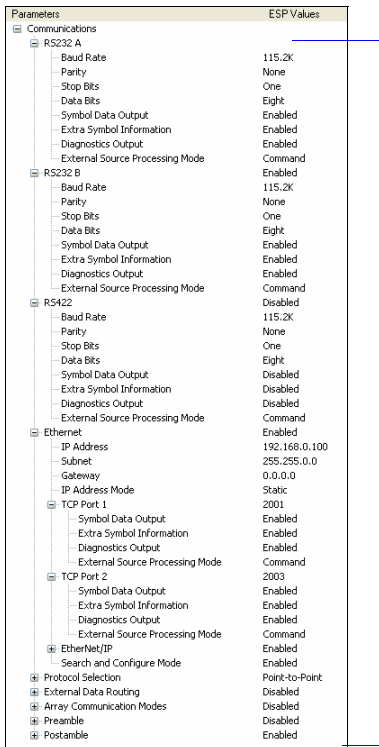

**RS-232 A, RS-232 B, and RS-422** are serial. RS-232 A is always enabled. RS-232 B and RS-422 can be enabled or disabled to match the physical requirements of the application. **Ethernet** can also be enabled or disabled as required.

RS-232 A, RS-232 B, and RS-422 can be configured for Baud Rate, Parity, Stop Bits, Data Bits, Symbol Data Output, Extended Data (Decodes Before Output, Symbol Position Output, etc.), Diagnostics Output, and External Source Processing Mode (Command or Data).

Ethernet can be configured for IP Address, Subnet Mask, Gateway, IP Address Mode, Symbol Data Output, Extended Data, Diagnostics Output, and External Source Processing Mode.

# Application Examples

The following examples demonstrate how the components described in previous pages can be deployed in industrial applications.

## Daisy Chain

**Daisy chain** configurations are used in applications such as product packaging, where single items have multiple symbols. For example, a box with one symbol on the top and symbols on either side requires at least three imagers to ensure that all symbols will be decoded.

The highlighted areas below demonstrate how a daisy chain can be arranged. One imager is placed above the conveyor line and one imager is placed on each side of the line. The three imagers essentially function as a single imager, and data is sent from the primary imager to the host or PLC.

**Important:** Do not attempt to power more than four imagers with a single power supply in a daisy chain configuration. Add a QX-1 and one power supply for every four additional imagers in the daisy chain.

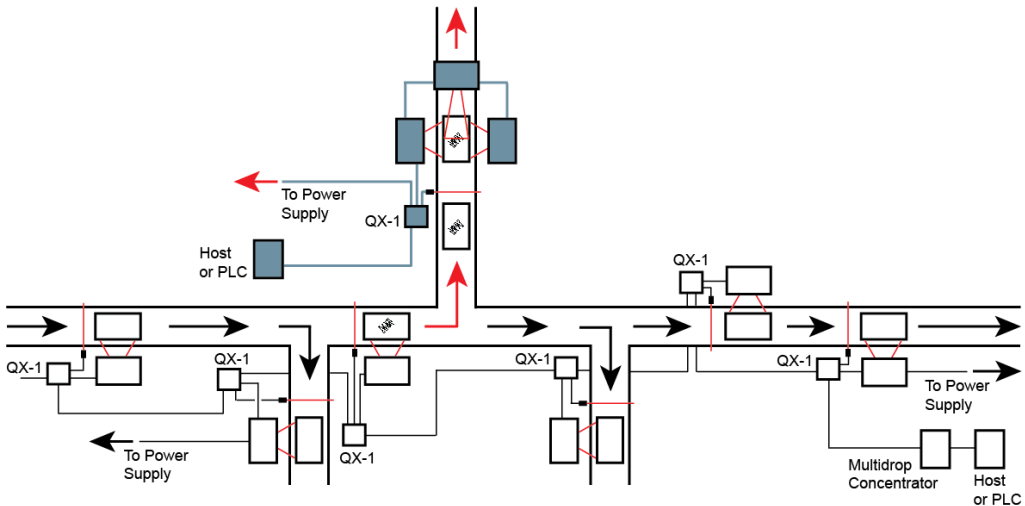

## Multidrop

**Multidrop** networks are used in applications where it is necessary to decode symbols at multiple locations within an industrial process. Imagers are placed at stations located between manufacturing steps, and data from those imagers is directed to a multidrop concentrator before being sent to a host. An example of this type of application is food packaging, in which part number data is collected and tracked throughout the packaging process.

The highlighted areas below demonstrate how a multidrop network can be arranged.

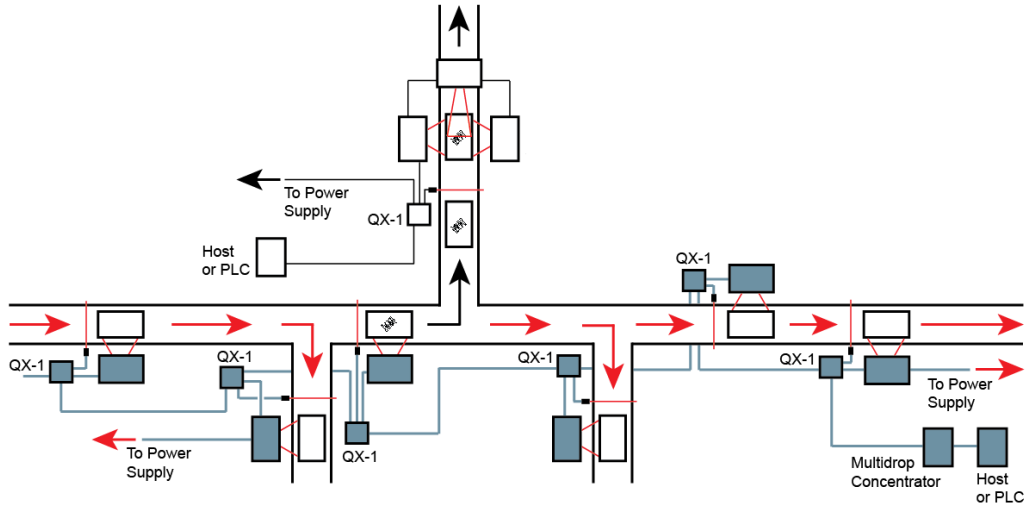

## Ethernet TCP/IP

**Ethernet TCP/IP** is the standard Ethernet interface used to connect multiple locations in a network, such as computers in an office network. It can also be used to network other communications devices, such as imagers and PLCs on a factory floor.

The highlighted areas below demonstrate how an Ethernet daisy chain can be arranged. Ethernet-enabled imagers can also be set up in standalone configurations, or multiple Ethernet-enabled imagers along a production or packaging line can be connected to Ethernet.

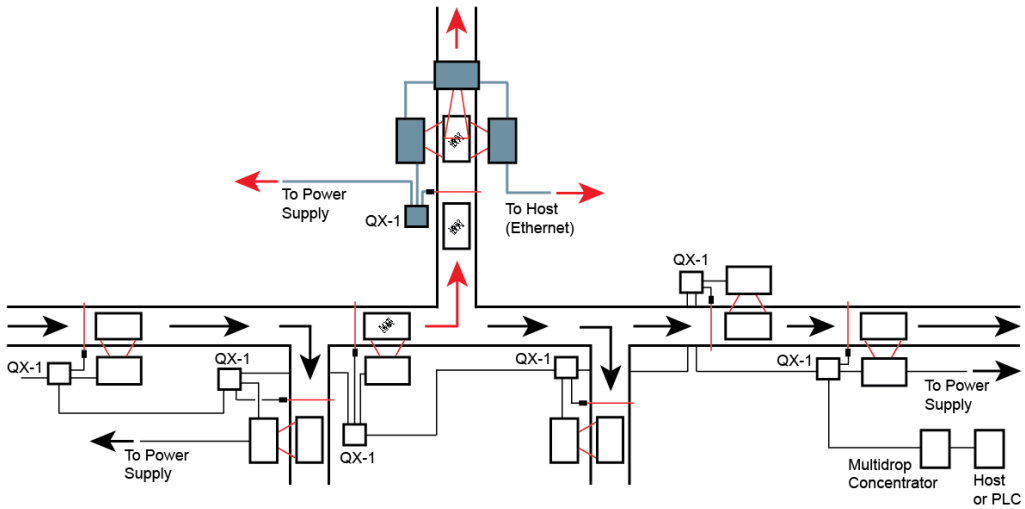

# 4 Setup

## Contents

Video.....	4-2
Evaluation .....	4-18
Calibration.....	4-21
Window of Interest.....	4-22
Configuration Database.....	4-24
Ordered Output.....	4-33
Output Format.....	4-37
Dynamic Setup .....	4-41

This section describes ESP's **Setup** interfaces: **Video**, **Evaluation**, **Calibration**, **Window of Interest**, **Configuration Database**, **Ordered Output**, **Output Format**, and **Dynamic Setup**. Each interface allows the user to make changes to imager configuration quickly and easily.



# Video

The **Video** view allows the user to perform the same **Locate**, **Calibrate**, and **Test** routines. There is also a focal distance adjustment tool to the right of the video view.

**Video** also features simple **Capture and Decode** functionality.

The screenshot shows the 'Video' view interface with the following components and callouts:

- Navigation Tabs:** Video, Evaluation, Calibration, WOI, Configuration Database, Ordered Output.
- Buttons:** Locate, Calibrate, Learn, Select Lens..., Capture and Decode, Test, Stop.
- Callouts:**
  - Locate:** Initiates Calibration routine. / Activates the imager's target pattern and initiates live video display of the symbol in the field of view.
  - Calibrate:** Initiates Data Matrix Learn operation.
  - Learn:** Initiates Select Reader Optics dialog.
  - Capture and Decode:** Allows the user to take an image capture of the symbol in the field of view at any time, and to decode the symbol data. Similar to the Capture and Decode function in the Configuration views.
  - Test:** Initiates the Test routine. Allows the user to test the imager's read rate and decodes per second, and also displays decoded symbol data in the field at the bottom of the screen. Click Stop to end the Test routine.
  - Stop:** Clicking this icon enables the focal distance slide control to the right of the video view. The focal distance value is displayed just below the icon.
  - Decodes per Second:** When Decodes per Second is checked, the read rate test displays how many decodes the imager achieves each second, instead of displaying a percentage.
  - Contrast:** When enabled, shows the symbol in higher contrast than the default contrast value.
  - Table:** Symbol data and Test results are shown in this field.

Attribute	
Number of Symbols	
Symbol #1	
Symbol Data	
- Field of View:** Displays a live video feed with a symbol (QR code) in the center.
- Focal Distance Control:** A vertical slider on the right side of the video view, with a focal distance value of 80 mm displayed below it.

## Learn

The **Learn** command, located in **ESP's EZ Mode** and in the **Setup** section on the **Video** tab, puts the QX Hawk into a mode of operation that will cause it to “learn” the next Data Matrix symbol decoded. Learn Mode remains active until either a Data Matrix symbol is decoded or Learn Mode is disabled by re-clicking the Learn button. Upon decoding a Data Matrix symbol, the QX Hawk's image processing will save pertinent information about the learned symbol so that subsequent identical symbols will be processed more quickly.

See [Learn Operations](#) in [Utilities](#) for other Learn commands that can be sent serially.

Click the **Learn** button to start Data Matrix Learn Mode.

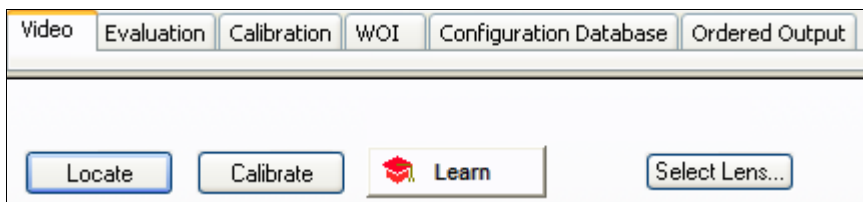

The **Learn** button will say “Learning” during the learn operation.

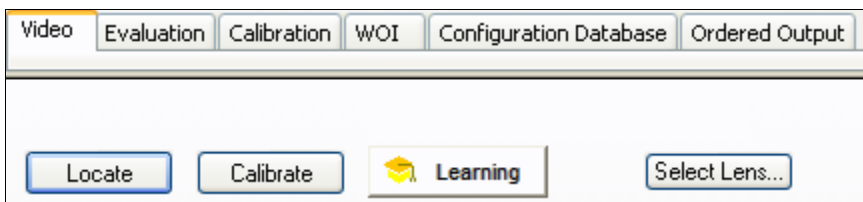

The **Learn** button will say “Learned” when the Data Matrix symbol has been learned.

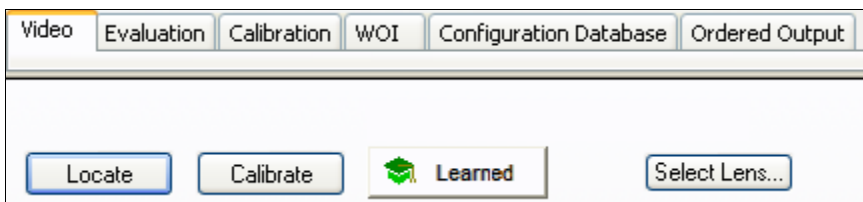

The learn state and parameters persist in the same way as ordinary parameters.

*Examples:*

- A QX Hawk in a **Learned** state has not been saved. Cycling power will remove any Learned state information and the imager will power-on in its configured state.
- A QX Hawk is saved in a **Learning** state. The imager will power-on in the Learning state and will learn the first Data Matrix symbol decoded.
- A QX Hawk is saved in a **Learned** state. The imager will power-on in the Learned state and will only decode the learned symbol type.
- A QX Hawk in a **Learned** state is issued a reset default command **<Ard>**. The unit will return to an **Unlearned** state but if power is cycled it will return to its saved state.

## Select Lens (Standard QX Hawk Only)

If you change the QX Hawk's lens, you must configure the Lens Type parameter to match the new lens type.

Click the **Select Lens** button on the **Video** tab.

To verify the lens type of your camera, power-off the QX Hawk (do not look into the targeting laser) and look at the outer rim of the unit's camera lens. You will see one of the following:

- '●' and '15' = Lens Type 1
- '●●' and '30' = Lens Type 2
- '●●●' and '45' = Lens Type 3 (Default)
- '○' and '12' = Lens Type 4

Select your lens type in the **Select Reader Optics** dialog and click **OK**.

You can calibrate the new lens by using the **<@OPTIC>** command.

**Important:** **<@OPTIC>** is not supported by the QX Hawk C-Mount Imager.

This parameter is "sticky". Once saved with a **<Z>** or **<Zc>** command, it can only be defaulted with **<Zrdall>** or **<K525d>**.

Select Lens...

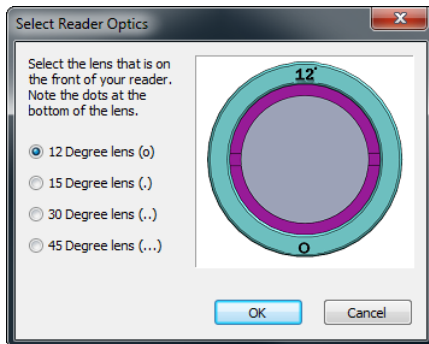

12 Degree Lens

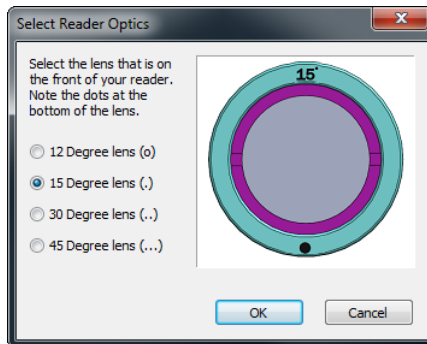

15 Degree Lens

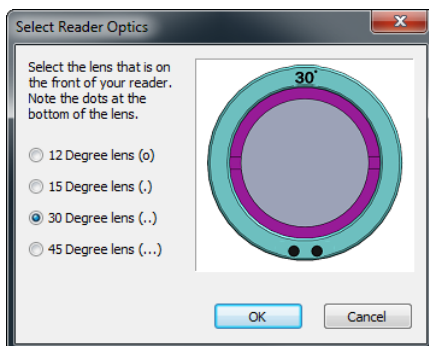

30 Degree Lens

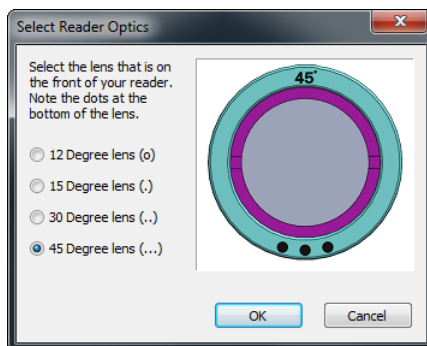

45 Degree Lens



## Camera Setup

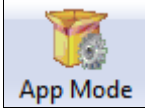

Click the **App Mode** button and then the **Setup** button.  
You will see the **Camera Setup** tree control to the right of the **Video** interface.

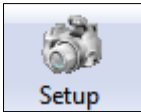

Parameters	ESP Values
[-] Camera Setup	
[-] Camera Settings	
Gain	20
Shutter Speed	2500
[-] Illumination Type	Bright Field
Brightness	High
[-] Focus Distance	80
Distance Units	Millimeters (mm)
Sub-sampling	Disabled*
[-] Window of Interest	Disabled*
Top	4 : 1
Left	16 : 1
Height	480
Width	752
[+] Image Processing Settings	

The \* indicates that the setting is the default.

To open nested options, **single-click** the +.

To change a setting, **double-click** the setting and use the cursor to scroll through the options.

**Note:** Communication settings can also be sent to the imager from ESP's Terminal using Microscan's K command format.

## CMOS (WVGA) Camera Settings

Camera Settings	
Gain	20
Shutter Speed	2500

### Gain

Sets the gain value for the image sensor. This setting can be configured through autocalibration, and is the recommended method for configuring this settings. A higher value will increase the brightness of the image, but the noise performance of the system is reduced. Prior to configuring the gain, the required shutter speed should be set, and the gain should be configured to optimize the shutter speed setting.

Camera Settings	
Gain	20 (0 - 33)
Shutter Speed	2500

### Shutter Speed

This value sets the exposure or integration time for the image sensor pixels. The shutter speed setting in relation to the speed of the object is critical. If an object is moving fast and a slow shutter speed is selected, blurring or smearing of the object will occur. As shutter speed is increased the amount of light required or gain needed has to be increased since the pixels exposure time has decreased.

Camera Settings	
Gain	20
Shutter Speed	2500 (60 - 40000)

## CCD (SXGA) Camera Settings

Camera Settings	
Gain	20
Shutter Speed	1500

### Gain

Sets the gain value for the image sensor. This setting can be configured through autocalibration, and is the recommended method for configuring this settings. A higher value will increase the brightness of the image, but the noise performance of the system is reduced. Prior to configuring the gain, the required shutter speed should be set, and the gain should be configured to optimize the shutter speed setting.

Camera Settings	
Gain	20 (0 - 64)
Shutter Speed	2500

### Shutter Speed

This value sets the exposure or integration time for the image sensor pixels. The shutter speed setting in relation to the speed of the object is critical. If an object is moving fast and a slow shutter speed is selected, blurring or smearing of the object will occur. As shutter speed is increased the amount of light required or gain needed has to be increased since the pixels exposure time has decreased.

Camera Settings	
Gain	20
Shutter Speed	1500 (30 - 150000)

## Illumination Type (Standard QX Hawk Only)

### Mode

Configures the illumination pattern. “Bright Field” is used for most applications. For Mode 4, the internal illumination is always off, similar to configuration setting 0 (Always Off).

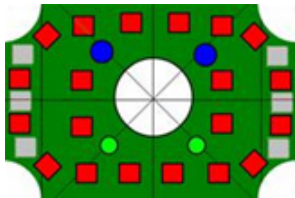
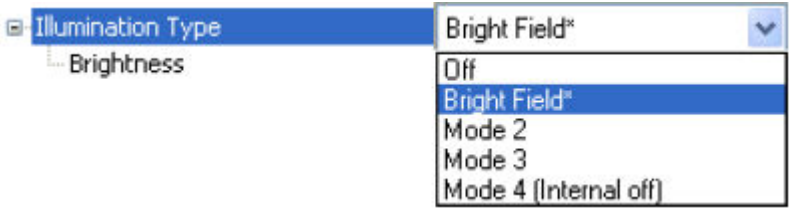

**Bright Field**

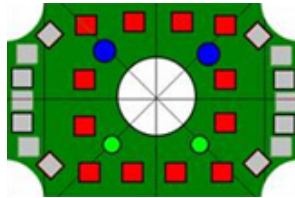

**Mode 2**

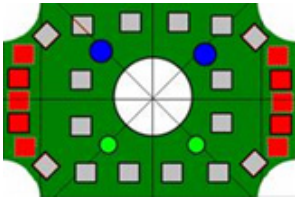

**Mode 3**

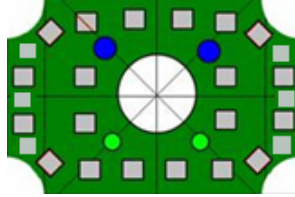

**Mode 4 (Internal LEDs Off)**

### Brightness

Configures the amount of illumination output from the unit's built-in lighting.



## External Smart Light (QX Hawk C-Mount Only)

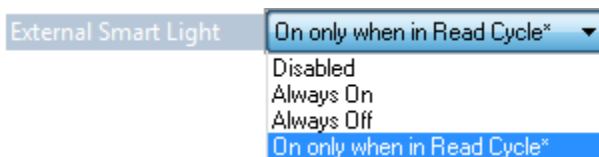

### ***Disabled***

When External Smart Light is set to Disabled, the external smart light control is disabled and Output 3 is available for any other operation.

### ***Always On***

When External Smart Light is set to Always On, the external smart light is continuously on.

### ***Always Off***

When External Smart Light is set to Always Off, the external smart light is continuously off.

### ***On Only When in Read Cycle***

When External Smart Light is set to On Only When in Read Cycle, the external smart light will be on when the imager is in an active read cycle.

**Important Note:** The external smart light's active state is controlled through the Output State of Output 3, which is used as the external control line. To control the external light using a Microscan standard 12-pin-to-5-pin external light control cable, set Output 3's Output State to Normally Closed and Output Common to ground. Any other settings that relate to Output 3, such as Output 3 Diagnostics will be ignored if this mode is enabled. The external light will be continuously on until the system is fully re-booted.

## Focus Distance

Provides focal distance adjustment for the camera.

**Focus Distance** limits are determined by the lens model and are defined in the table below. Any value outside this range will be rejected.

Lens Model	Millimeters		Parameter Range	Inches		Parameter Range
	Min. Distance	Max. Distance		Min. Distance	Max. Distance	
15°	38	229	38 to 229	1.5	9.0	150 to 900
30°	25	1016	25 to 10,160	1.0	40.0	100 to 4000
45°	25	1016	25 to 10,160	1.0	40.0	100 to 4000
12°	76	343	76 to 343	3.0	13.5	300 to 1350

When **Distance Units** is set to **millimeters**, the focal distance parameter has a range of **25 to 4000**.

When **Distance Units** is set to **1/100 inch**, focal distance is limited to a range of **100 to 4000**. If you attempt to set the focal distance to less than **100 (1 inch)**, the parameter will be set to **100**.



## Distance Units

Defines the measurement unit value of the Focus Distance parameter.

Distance Units can be set to millimeters or inches.



## Sub-Sampling

The camera can be enabled to sub-sample pixels in the specified image frame. Sub-sampling can be specified as either 4:1 or 16:1, which signifies the sampling rate.

**Note:** Sub-Sampling is not available for the CCD model of the QX Hawk.

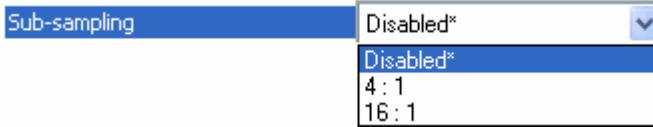

### 4:1

1 pixel output for every 4 pixels sampled. When selected the image will be sampled 2:1 in the vertical direction and 2:1 in the horizontal direction for a combined 4:1 ratio. An image with a dimension of 640 x 480 will be scaled to 320 x 240.

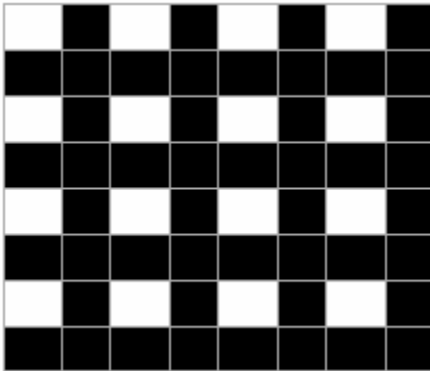

### 16:1

1 pixel output for every 16 pixels sampled. When selected the image will be sampled 4:1 in the vertical direction and 4:1 in the horizontal direction for a combined 16:1 ratio. An image with a dimension of 640 x 480 will be scaled to 160 x 120.

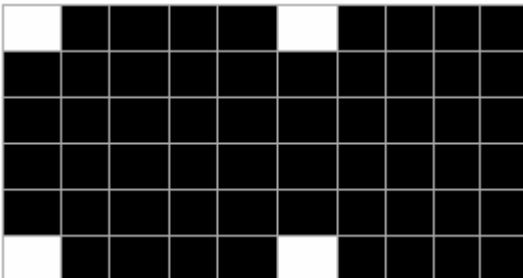

## CMOS (WVGA) Window of Interest

Window of Interest	
Top	0
Left	0
Height	480
Width	752

The active pixel area of the image sensor is defined as the “Window of Interest” (WOI). This allows the user to select an area in the Field of View that the desired symbol will be located. The programmable window of interest is useful for increasing decode speed, improving threshold, selecting desired symbol from multiple symbols in FOV. The user provides the upper-left pixel location and the size in both rows and columns to define the Window of Interest.

### Important Notes:

- The column width value is required to be a modulus 32 value, so regardless of the column width setting that is configured the actual column width will be decreased (if required) to a modulus 32 value. For example a column width value of 632 would actually be 608. A user request of this setting would still return 632.
- The column pointer is required to be an even value, so regardless of the column pointer setting that is configured the actual column pointer will be decreased (if required) to an even value. For example a column pointer value of 101 would actually be 100. A user request of this setting would still return 101.

### Top

Defines the row position of the upper-left starting point of the image window.

Window of Interest	
Top	0 (0 - 480)
Left	0
Height	480
Width	752

### Left

Defines the column position of the upper-left starting point of the image window.

Window of Interest	
Top	0
Left	0 (0 - 752)
Height	480
Width	752



## Height

Defines the size, in rows, of the image window. Maximum value is defined as the Maximum row size of Image sensor, minus the row pointer value.

Window of Interest

Top	0	
Left	0	
Height	480	3 to (480 - Top)
Width	752	

## Width

Defines the size, in columns, of the image window. Maximum value is defined as the Maximum column size of Image sensor, minus the column pointer value.

Window of Interest

Top	0	
Left	0	
Height	480	
Width	752	8 to (752 - Left)

## CCD (SXGA) Window of Interest

Window of Interest	
Top	0
Left	0
Height	960
Width	1280

The active pixel area of the image sensor is defined as the “Window of Interest” (WOI). This allows the user to select an area in the Field of View that the desired symbol will be located. The programmable window of interest is useful for increasing decode speed, improving threshold, selecting desired symbol from multiple symbols in FOV. The user provides the upper-left pixel location and the size in both rows and columns to define the Window of Interest.

### Important Notes:

- The column width value is required to be a modulus 32 value, so regardless of the column width setting that is configured the actual column width will be decreased (if required) to a modulus 32 value. For example a column width value of 632 would actually be 608. A user request of this setting would still return 632.
- The column pointer is required to be an even value, so regardless of the column pointer setting that is configured the actual column pointer will be decreased (if required) to an even value. For example a column pointer value of 101 would actually be 100. A user request of this setting would still return 101.

### Top

Defines the row position of the upper-left starting point of the image window. An Increase in this value will cause an increase in frame rate at a resolution of 46 microseconds (row period). If this value is changed and the resulting combination of row pointer plus row depth exceeds the maximum allowed, the row depth will be decreased to an acceptable value.

Window of Interest	
Top	0 (0 - 960)
Left	0
Height	960
Width	1280

### Left

Defines the column position of the upper-left starting point of the image window. If this value is changed and the resulting combination of column pointer plus column width exceeds the maximum allowed, the column width will be decreased to an acceptable value.

Window of Interest	
Top	0
Left	0 (0 - 1280)
Height	960
Width	1280

## Height

Defines the size, in rows, of the image window. Maximum value is defined as the Maximum row size of Image sensor, minus the row pointer value. A decrease in this value, coupled with an increase in the row pointer value, will cause an increase in frame rate at a resolution of 46 microseconds (row period).

Window of Interest

Top	0
Left	0
Height	960 <input type="text"/> 3 to (960 - Top)
Width	1280

## Width

Defines the size, in columns, of the image window. Maximum value is defined as the Maximum column size of Image sensor, minus the column pointer value. Changing this parameter will have no effect on frame rate.

Window of Interest

Top	0
Left	0
Height	960
Width	1280 <input type="text"/> 8 to (1280 - Left)

## Image Processing Settings

### Image Processing Timeout

See [Image Processing Timeout](#) in [Read Cycle](#).

### Capture Mode

See [Capture Mode](#) in [Read Cycle](#).

## Morphological Pre-Processing

**Morphological Pre-Processing** allows the user to select the method for processing images, and to choose the operator size for that method.

**Important:** This command must be set to **Enabled** for **Morphological Operation** to function.

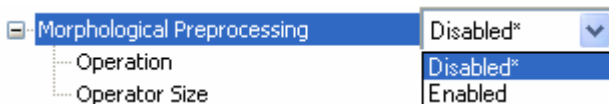

## Morphological Operation and Operator Size

### Operation

**Morphological Operation** allows the user to select the method for processing captured images.

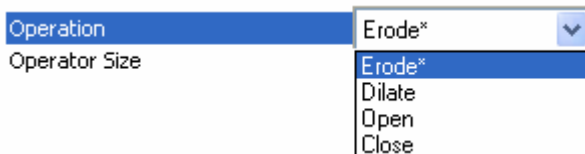

### Erode

**Erode** increases the dark cell size of a symbol. Useful for increasing the dark cell size of a dark-on-light Data Matrix symbol.

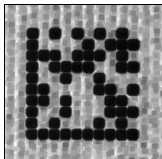

### Dilate

**Dilate** increases the light cell size of a symbol. Useful for increasing the light cell size of a light-on-dark Data Matrix symbol.



### Open

**Open** removes minor light defects of dark cells by performing a **Dilate** function followed by an **Erode** function.

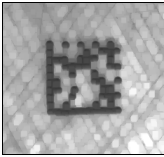

### Close

**Close** removes minor dark defects of light cells by performing an **Erode** function followed by a **Dilate** function.

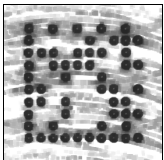

### Operator Size

**Operator Size** determines the size of the area or “pixel neighborhood” (measured in pixels) in which the morphological operation is being performed.



#### **Small (3 pixels by 3 pixels)**

Medium (5 pixels by 5 pixels)

Large (7 pixels by 7 pixels)

# Evaluation

In **Evaluation**, you can view images currently in the imager, capture and decode a symbol, save it as a digital file, and perform histogram and line scan evaluations.

When you click on the **Evaluation** tab, you will see the images that are currently stored in the imager.

Click **Receive** to refresh this view.

Click **Read** to trigger a read cycle. If there is enough time in the read cycle, up to 32 good reads (or 6 full-scale images) can be captured and displayed, depending on the size of the images, and depending on the number enabled in **Number of Captures** under **Capture Mode** in the **Camera Setup** menu tree to the left of the tabs.

If you click **Save**, the current image will be saved to the location of your choice.

**Note:** An image can only be saved in the format in which it was uploaded to **ESP**. JPEG images will be saved as **.jpg**, and bitmaps will be saved as **.bmp**.

When you click the **JPEG Image** box, notice that the **Line Scan** button is grayed out.

The JPEG option allows faster captures and transfers, but since the JPEG standard compresses image data, it is not suitable for the more rigorous demands of line scan evaluation.

JPEG also allows you to adjust the image quality (resolution) by adjusting the sliding tab between 1 and 100, 1 being the lowest quality and 100 being the highest.

When possible, use the highest quality; when image transfer speed must be increased, use a lower image quality setting. Adjustments for this setting will depend on your specific hardware and software limitations.

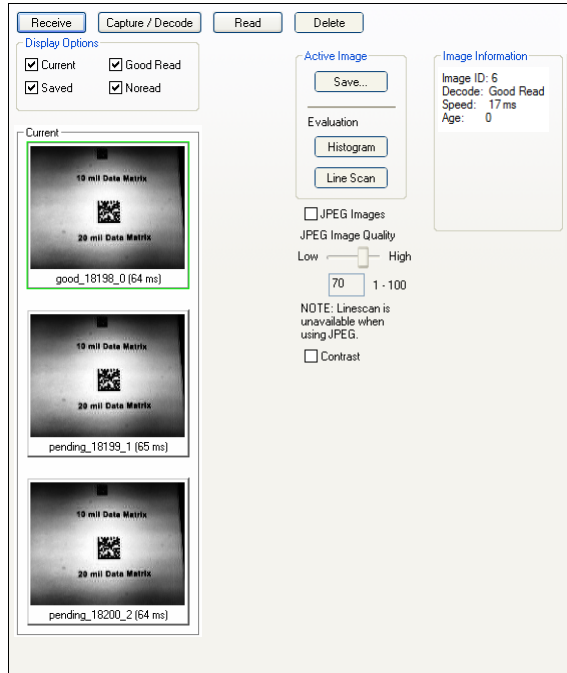

## Histogram

The **Histogram** function is useful in determining quality and contrast of symbols. A histogram is a graphic representation of the numeric count of the occurrence of each intensity (gray level) in an image. The horizontal axis represents the values of gray levels, and the vertical axis represents the number of pixels for each gray level.

**Note:** Since histograms are performed in the imager, the results will be saved regardless of whether the image was uploaded as a JPEG (.jpg) or a bitmap (.bmp).

1. From the **Evaluation** window, click the **Histogram** button.

The current image is transferred into the histogram operation. This may take a moment, since all the relevant pixels are being evaluated intensively.

2. When the **Histogram** window opens, you may need to expand the window and/or adjust the scroll bars in order to bring the image into view.
3. To generate a histogram, click and drag your cursor diagonally across the symbol or a portion of the symbol.

The image will be surrounded by an “area of interest box”, a dashed blue line with red anchor points that can be selected and moved by placing a cursor inside the box, and can be resized by clicking and dragging the anchor points.

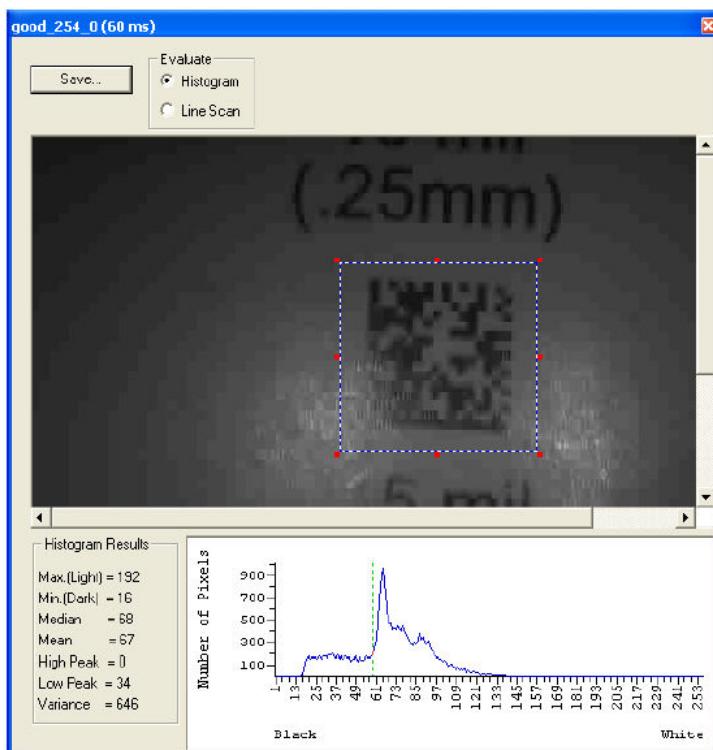

## Line Scan

1. From the **Evaluation** tab, click the **Line Scan** button. A window like that shown below will appear.
2. Drag your cursor *horizontally* across the image.  
This will create a dashed horizontal line. Pixel information and a visual representation of the dark and light pixels will be displayed below the image.

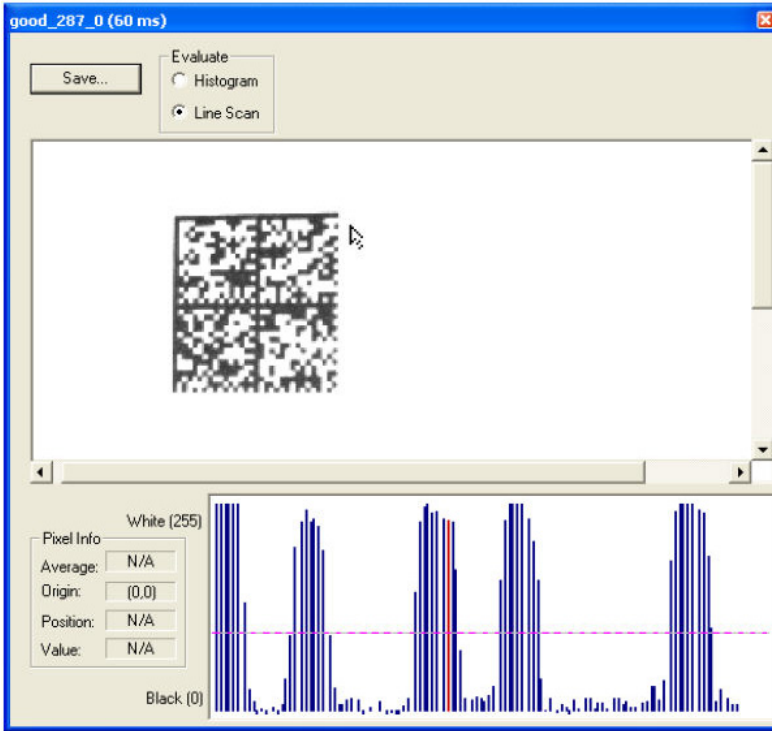

When you center your cursor over the dashed line, it becomes a double arrow cross. This allows you to move the line anywhere in the window. You can also use your keyboard arrows to move the line incrementally in any direction.

As with the histogram, the line scan compares light and dark pixels, but in a spatial distribution. On the **Y** axis of the graph below, **0** is black and **255** is white; the **X** axis represents the horizontal axis of the symbol as described by the line scan.

When you click anywhere on the graph, a vertical red line appears at that point and its position and value (in terms of black-to-white) are updated in the **Pixel Info** table to the left of the graph (237 in this example). In addition, a horizontal dashed red line is displayed that indicates the average value.



# Calibration

The Calibration interface in **ESP** is a powerful and intuitive way to optimize the imager's performance. It allows the user to control several complex, simultaneous calibration operations, and to follow the progress of those operations using cues such as progress bars, real-time representations of calibration values, and other dynamic user feedback.

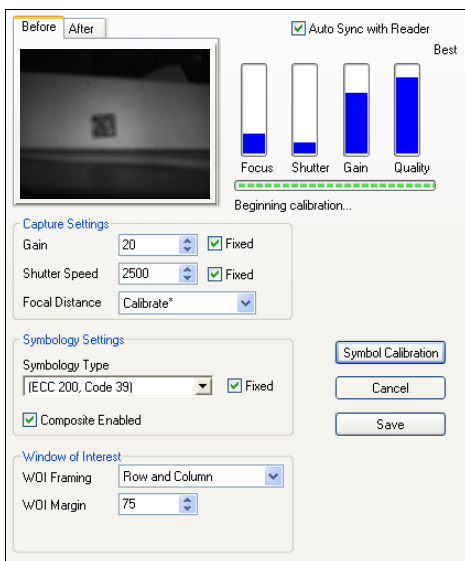

*ESP's Calibration interface shown during a calibration routine*

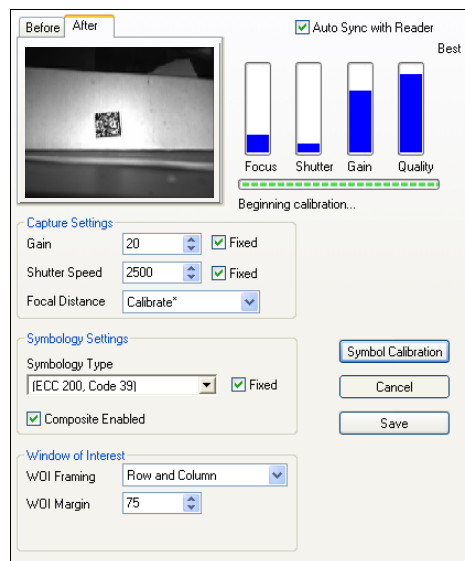

*ESP's Calibration interface shown after a calibration routine*

# Window of Interest

The active pixel area of the image sensor is called the **Window of Interest (WOI)**. The WOI allows the user to select an area of the field of view in which the desired symbol is located.

The programmable window of interest increases decode speed, improves threshold, and makes it easy to select specific symbols from among several in the field of view. The user provides the upper-left pixel location and the size of the window to define the Window of Interest.

## **Window of Interest (CMOS)**

[-] Window of Interest	
Top	0
Left	0
Height	480
Width	752

## **Window of Interest (CCD)**

[-] Window of Interest	
Top	0
Left	0
Height	960
Width	1280

**Caution: Window of Interest** will shrink the field of view and therefore could cause symbols to be missed in dynamic applications.

## Window of Interest Graphic Interface

1. From the **Camera** menu, click the **WOI** tab to bring up **Window of Interest**.

If you haven't already captured an image, click the **Capture and Decode** button to decode the present image. If successful, the **Good Read** indicator on the **WOI** tab will be green and the symbol will appear in the pane below.

**Note:** You can resize the image by clicking and dragging the **ESP** window from the lower right corner. This is useful where very small symbols are being read.

2. Click and drag your cursor over the symbol that you want to isolate for reading.

Notice that the surrounding area goes black.

You can use the handles on the image area that you have just drawn to resize the region of interest. You can also click on the center of the window of interest and move it.

3. Test the new settings in **Read Rate Mode**.

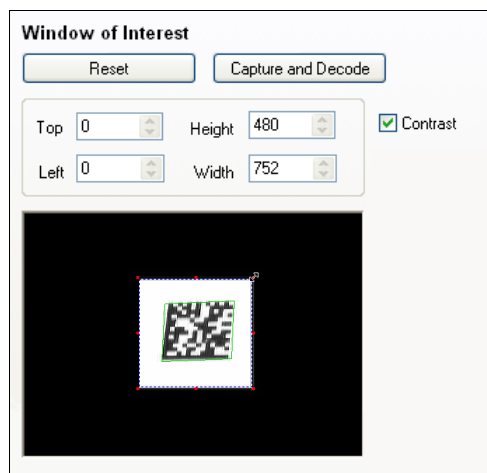

**Note:** To remove the window of interest, click the **Reset** button or click anywhere in the WOI pane.

Note that all pixels not in the WOI are defined as black.

Because the imager has far less processing to do in a smaller window, read rates typically increase dramatically. One possible downside is that the chance of missing a symbol increases with the smaller window. Always verify that your WOI will be large enough to allow for any random movement of symbols in your field of view.

# Configuration Database

The Configuration Database allows the user to manage multiple configuration profiles. It is a useful tool in applications that require several different imager configurations to be applied sequentially, and it allows the user to perform far more complex operations than would be possible with only one set of configuration parameters.

The screenshot shows the Configuration Database interface. At the top, it displays 'Active Indexes' set to 5, a checked 'Auto Sync Database settings with Reader' option, and an 'Advanced Options...' button. Below this are two main sections: 'Capture Settings' and 'Processing Settings'. The 'Capture Settings' section includes parameters like Capture Index, Shutter Speed, Gain, Focal Distance, Sub-sampling, Top, Left, Height, and Width. The 'Processing Settings' section includes Morphology Operation, Morphology Size, and Symbol Type. A 'Current' row shows the active settings: 2500, 20, 80, Disabl, 0, 0, 480, 752, and Erode, Small, ECC 200. Below this is a table of 10 indexes, with index 1 highlighted. At the bottom, there are checkboxes for 'Capture for Every Index', 'Show Database Index in Output', and 'Sort Index Positions on Good Reads', along with buttons for 'Calibrate...', 'Receive Settings', 'Send Settings', 'Load Current To Index', and 'Load Index To Current'.

Index	Capture Index	Shutter Speed	Gain	Focal Distance	Sub-sampling	Top	Left	Height	Width	Morphology Operation	Morphology Size	Symbol Type
Current	2500	20	80	Disabl	0	0	480	752	...	Erode	Small	ECC 200
1	2500	20	80	Disabl	0	0	480	752	...	Disabl	Small	Disabled Test
2	2500	20	80	Disabl	0	0	480	752	...	Disabl	Small	Disabled Test
3	2500	20	80	Disabl	0	0	480	752	...	Disabl	Small	Disabled Test
4	2500	20	80	Disabl	0	0	480	752	...	Disabl	Small	Disabled Test
5	2500	20	80	Disabl	0	0	480	752	...	Disabl	Small	Disabled Test
6	2500	20	80	Disabl	0	0	480	752	...	Disabl	Small	Disabled Test
7	2500	20	80	Disabl	0	0	480	752	...	Disabl	Small	Disabled Test
8	2500	20	80	Disabl	0	0	480	752	...	Disabl	Small	Disabled Test
9	2500	20	80	Disabl	0	0	480	752	...	Disabl	Small	Disabled Test
10	2500	20	80	Disabl	0	0	480	752	...	Disabl	Small	Disabled Test

Configuration Database view, CMOS, set for 5 Active Indexes, with Capture Settings highlighted

As soon as the number of active database settings is something other than 0, the database is enabled. Once enabled, the current configuration settings (that are handled by the database) have no impact on imager operation.

## ***Capture Index***

Each index in the database (1 – 10) can be configured and tested individually.

## ***Shutter Speed (CMOS)***

Sets the camera's shutter speed (60 – 40,000, default **2,500**) for the selected index.

## ***Shutter Speed (Standard QX Hawk CCD)***

Sets the camera's shutter speed (30 – 150,000, default **1,500**) for the selected index.

## ***Shutter Speed (QX Hawk C-Mount CCD)***

Sets the camera's shutter speed (30 – 150,000, default **2,500**) for the selected index.

## ***Gain (CMOS)***

Sets the camera's gain (0 – 33, default **20**) for the selected index.

## ***Gain (CCD)***

Sets the camera's gain (0 – 64, default **20**) for the selected index.

## ***Focal Distance (Standard QX Hawk Only)***

Sets the camera's focal distance (25 – 4,000, default **80**) for the selected index.

## ***Sub-Sampling (Standard QX Hawk Only)***

Sets the sub-sampling rate (4:1 or 16:1, **Disabled** by default) for the selected index.

**Important:** Sub-Sampling has no effect when the "Image Dimension" mode is configured as Region of Interest in the Database Mode command. This is because the camera Window of Interest is determined by the software based on the database ROI setup and there is no benefit to sub-sampling to increase speed, as the frame size would have to be increased to account for the sub-sampling.

## ***Morphology Operation***

Allows the user to select the method for processing captured images.

Parameter values for **serial command <K255>**:

**0 – Disable**

1 – Erode

2 – Dilate

3 – Open

4 – Close

## ***Morphology Size***

Determines the size of the area or “pixel neighborhood” (measured in pixels) in which the morphological operation is being performed.

Parameter values for **serial command <K255>**:

**3 – Small (3 pixels by 3 pixels)**

5 – Medium (5 pixels by 5 pixels)

7 – Large (7 pixels by 7 pixels)

## ***Top/Left/Height/Width (CMOS)***

The image dimension settings can be applied as a Window of Interest or a Region of Interest depending on the image dimension mode selected in the Database Mode command.

Top: 0 to (480 – height) Default: **0**

Left: 0 to (752 – width) Default: **0**

Height: 3 to (480 – top) Default: **480**

Width: 8 to (752 – left) Default: **752**

## ***Top/Left/Height/Width (CCD)***

The image dimension settings can be applied as a Window of Interest or a Region of Interest depending on the image dimension mode selected in the Database Mode command.

Top: 0 to (960 – height) Default: **0**

Left: 0 to (1280 – width) Default: **0**

Height: 3 to (960 – top) Default: **960**

Width: 8 to (1280 – left) Default: **1280**

## Symbol Type

This field allows the user to configure the database to operate on specific symbol types for selected database index. Symbol type-specific parameters must be configured with the appropriate symbol type command. For example, fixed length Code 128 is required; it must be set up with the Code 128 command **<K474>**. To configure a symbol type, simply add the number value associated with the symbol type to the field parameter.

*Example:* If Data Matrix and Code 39 are required, the parameter would be  $2 + 16 = 18$ . See [I/O Parameters](#) for a description of how to enter these values via serial command.

### Disabled

When disabled, the database uses the current Symbol Type setup to determine active symbol types.

### Any Type

All of the preceding symbol types, except Pharmacode, are enabled while this database index is being used.

*Add 1.*

### Data Matrix

If enabled, Data Matrix will be active for this database index.

**Important:** The ECC Level must be configured using the Data Matrix command **<K479>**. If no ECC level has been configured, then it will not decode a Data Matrix symbol.

*Add 2.*

### QR Code

If enabled, QR Code will be active for this database index.

*Add 4.*

### Code 128

If enabled, Code 128 will be active for this database index.

*Add 8.*

### Code 39

If enabled, Code 39 will be active for this database index.

*Add 16.*

### Codabar

If enabled, Codabar will be active for this database index.

*Add 32.*

### **Code 93**

If enabled, Code 93 will be active for this database index.

*Add 64.*

### **Interleaved 2of 5**

If enabled, Interleaved 2of 5 will be active for this database index.

*Add 128.*

### **UPC**

If enabled, UPC will be active for this database index.

*Add 256.*

### **PDF417**

If enabled, PDF417 will be active for this database index.

*Add 512.*

### **MicroPDF417**

If enabled, MicroPDF417 will be active for this database index.

*Add 1024.*

### **BC412**

If enabled, BC412 will be active for this database index.

*Add 2048.*

### **Pharmacode**

If enabled, Pharmacode will be active for this database index.

*Add 4096.*

### **DataBar-14**

If enabled, DataBar-14 will be active for this database index.

*Add 8192.*

### **DataBar Limited**

If enabled, DataBar Limited will be active for this database index.

*Add 16384.*



## **DataBar Expanded**

If enabled, DataBar Expanded will be active for this database index.  
*Add 32768.*

## **Micro QR Code**

If enabled, Micro QR Code will be active for this database index.  
*Add 65536.*

## **Aztec**

If enabled, Aztec will be active for this database index.  
*Add 131072.*

## **Current Postal Symbology**

If enabled, Current Postal Symbology will be active for this database index.  
*Add 262144.*

## ***Database and Capture Modes***

The configuration database behaves the same for both “Rapid” and “Continuous” Capture Mode, the only discernable difference is in “Rapid” capture mode the database incrementing always operates in “Number of Image Frames” with a “frame count” of 1.

## ***Camera Settings***

When the database loads a camera configuration and there is a change in shutter speed (integration time), window of interest (WOI), or sub-sampling from the last image that was captured; Then one image frame needs to be processed to setup the new configuration prior to capturing an image.

The capture will start immediately following the integration period.

If the image dimensions are configured as a Region of Interest (ROI), then a change to these values does not incur the additional image frame since it is no longer a camera setting.

Since some image capture events require that an image frame delay occur and some don't, this does complicate the image capture time when the Configuration Database is enabled.

### **Notes:**

- If no camera change occurs, the start of the image capture is immediate upon being triggered.
- If a camera change occurs, the start of the image capture occurs after the shutter time has completed. In the case above, the image capture would incur a 1ms delay.

## ***Number of Active Indexes***

Number of database records (groups of settings) that will be used automatically during the read cycle. If set to 0, the imager only uses the current settings, not database entry settings.

## ***Sort Database***

Activates a sort function that moves the database entry associated with the last decode to the first position in the database and moves all other entries up.

---

## **Database Mode**

### **Switch Mode**

Selects the event that causes the imager to load the next entry from the database to current, active settings. When timer/count expires and “Image Process Looping” is enabled the next database entry that has a camera modification will be used.

#### **Notes:**

Capture event always occurs when the 1st database entry is used.

This setting has no effect in Rapid Capture mode.

Rapid Capture mode always operates in “Number of Frames” mode, with a “Frame Count” = 1.

### **Time**

The imager will load the next entry from the database to current after a defined time interval. The timer will start upon use of a database entry. In other words, if the timer expires during a capture event, the timer will not start again until the database entry has been incremented and the new entry has been loaded to current.

### **Number of Image Frames**

Database index is incremented after the specified number of image frames have been captured.

### **Frame Count/Time**

Indicates the “Number of Frames” that will occur or the amount of “Time” that is required before the imager will load the next database configuration. Timer resolution is 1ms.

### **Image Process Looping**

This feature is useful for processing a captured image frame multiple times with different Image Process/Decode parameters.

### **Disabled**

An image is captured for every database configuration, regardless if a camera setting has been modified.

### **Enabled**

When a database configuration is loaded to current, and the Camera settings have not changed from last capture event, a new image is not captured. But rather the last image frame that was captured is re-processed with the new Image Processing/Decode configuration. The one exception is with the 1st database index, a new image is always captured when the 1st database configuration is used. When a camera setting has been modified from one database setting to the next, a new image is captured. For example, if all database entries contained the same camera setting values, but had different IP/Decode configurations, the only time an image frame would be captured would be when the 1st database configuration was used.

## Image Dimensions

This feature defines how the image dimension parameters are implemented.

## Window of Interest (WOI)

In this mode the database image dimension parameters are Camera Settings and dictate the size of the image to be captured.

## Region of Interest (ROI)

In this mode the database image dimension parameters are Image Processing\Decode Settings and specify the region or area of the captured image to be processed. The ROI coordinate data is based on the full scale image size. The WOI of the captured image will be configured to cover all the active database ROI settings. In the following example there are three active database setting, with different ROI configurations. Their coordinates are based at point 0,0 of the full scale image (SXGA = 1280 x 1024 or VGA = 640 X 480). The image WOI is not configurable, it is automatically setup by the database, based on the ROI settings.

This feature is intended to be used in conjunction with the “Image Process Looping” feature, to allow processing different regions of a captured image with different Image Processing Decode Settings. In addition, if combined with “Output Filtering” the user can order the output of decoded symbols in a captured image frame by their location in the Field of View.

## ***Multiple Symbols with Same Symbol Data Operation***

ROI can be used to decode more than one of the same symbols and treat them as different symbols. Multi Symbol Operation will work within the following rules:

- Multiple symbols of same symbol data can only be handled by using ROI mode. This can only be done between different ROI IP Region settings.
- ROI IP Region settings within the database must be sequential (Not Interlaced) in order to correctly know when a new region has been tried. If Database slot 2 and 3 are swapped, the imager would then treat them as 4 separate ROI regions. This would result in 4 different symbols with GDR of 1 instead of 2 different symbols with GDR count of 2.
- ROI Regions will count the same symbol in the same region as additional decodes, but only spanning multiple frames. Each decode of same symbol with same ROI will add to the GDR count with additional frames.
- Multiple symbols can be within each ROI Region but cannot identify multiple Same Symbols. If same symbol is in a ROI twice per frame then it will be counted as 1 decode or 1 more GDR count, the second will be ignored.
- Filtering can only be done with database # because all other data is same.

## Ordered Output

Output filtering is a method of providing a set of good read qualifiers and also providing ordered output. There is a filter for up to the first 10 positions in a multisymbol output. The first filter corresponds to the first symbol output at the end of the read cycle. Each filter has settings for the following parameters: **Filter Number**, **Symbology Type**, **Length**, **Wildcard**, **Placeholder**, **Matching Data**, **Decode Direction**, and **Database Number**.

**Filter Number**, **Symbology Type**, **Length**, **Wildcard**, **Placeholder**, and **Matching Data** are all displayed in the table below. Double-clicking on any row of the table will display the **Ordered Output Filter Settings** dialog, where settings can be changed.

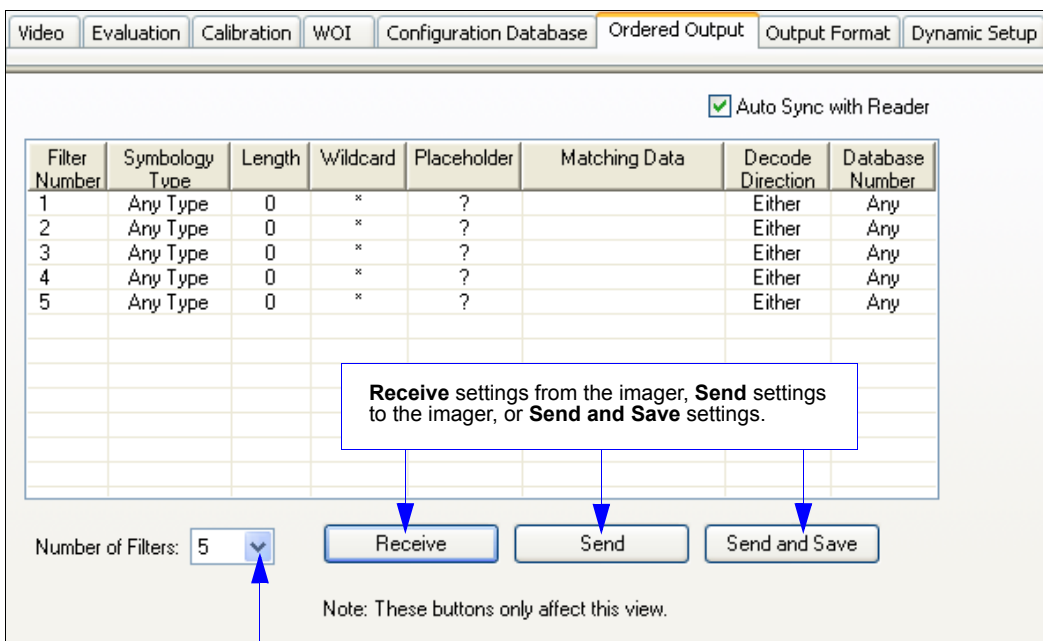

Video Evaluation Calibration WOI Configuration Database **Ordered Output** Output Format Dynamic Setup

Auto Sync with Reader

Filter Number	Symbology Type	Length	Wildcard	Placeholder	Matching Data	Decode Direction	Database Number
1	Any Type	0	*	?		Either	Any
2	Any Type	0	*	?		Either	Any
3	Any Type	0	*	?		Either	Any
4	Any Type	0	*	?		Either	Any
5	Any Type	0	*	?		Either	Any

Number of Filters: 5

Receive Send Send and Save

Note: These buttons only affect this view.

**Number of Filters** refers to the number of active output filters. **0** disables all output filters. Any non-zero numeral will enable output filtering to be performed using the filter indexes covered by this value.

For example, if the number of filters is **5**, then filter indexes 1, 2, 3, 4, and 5 will be applied.

## Filter Number

This is the filter index number that represents the position of the symbol in the data output at the end of the read cycle. This index number should be entered along with the following filter settings for the predetermined symbol position.

## Symbology Type

Specifies the symbology type allowed to occupy this location in multisymbol output.

**Note:** To filter or order a symbol, the symbol must meet all the requirements of the selected filter index.

## Length

Specifies the length of the decoded symbol allowed to occupy this location in multisymbol output.

**Note:** To filter or order a symbol, the symbol must meet all requirements of the selected filter index.

## Wildcard

This is the character to be used in the data output field when performing a data filter comparison. The wildcard character represents the end of matching, and allows for variable lengths of symbol output.

## Placeholder

The placeholder character requires a character to be present, but does not compare the data value.

## Matching Data

This is the data string to be used when comparing symbol data for output filtering and ordering. This data string may also contain wildcard and placeholder characters to facilitate matching. Remember that in order to filter or order symbol data, it must meet all the requirements of the selected filter index.

*Examples:*

- Filter data = "123\*". This will match data strings of "123", "123456", and "123ABC", but not "12".
- Filter data = "123\*AB?C". This will be interpreted as "123\*".
- Filter data = "123?". This will match "1234" and "123A", but not "123", "12345", or "1234C".
- Filter data = "123?A". This will match "1234A" and "123BA", but not "123", "1234C", or "1234ABCD".
- Filter data = "123?A?". This will match "1234AB" and "123BAT", but not "1234A" or "123BATS".
- Filter data = "12??\*". This will match "1234", "123456", and "123ABC", but not "12" or "123".
- Filter data = "123?A\*". This will match "1234A", "123BA", and "123BATS", but not "1234" or "1234C".

## Ordered Output Filter Settings

Ordered Output Filter Settings

Filter # 1 Criteria

Symbology Type: Any Type

Length: 0

Enter Match String

Matching String: \*

ASCII Lookup: CR Add to Match String

Match String Definables

Wildcard Character: \*

Placeholder Character: ?

Database Number: Any

Apply Cancel

Double-clicking on a row in the Ordered Output table brings up the **Ordered Output Filter Settings** dialog.

Use these settings to determine **Symbology Type**, **Length** of the symbol, a user-defined **Matching String**, **ASCII Lookup**, **Wildcard Character**, **Placeholder Character**, and **Database Number**. Click **Apply** to save the settings to the corresponding filter.

## **Rules for Output Filter Configuration**

### **Output Filter Configuration Rule # 1**

Each symbol that is decoded must match one of the filters before it can be saved to a read cycle record. There is an exception to this rule, however, when the number of symbols required for a read cycle exceeds the number of active filters. In such a case, unfiltered symbols can be placed into unfiltered output positions.

For example, if the number of symbols required is 6 but there are only 5 active filters, the last position can be filled by any (unfiltered) qualified symbol.

### **Output Filter Configuration Rule # 2**

The same filter setup can be used multiple times.

For example, filters 1, 2, and 3 can be set up to filter Code 39 symbols, and the output will occur in the order the symbols are decoded.

### **Output Filter Configuration Rule # 3**

All qualified symbols will be sorted and output in the matching filter position. If a symbol matches filter 3, it will be output as the third symbol. If a filter does not have a matching qualified symbol, a No Read message will be output in place of the symbol (assuming the No Read message is enabled).

For example, if there is not a symbol that meets filter 3's requirements, then a No Read message will be output in the third output position.



# Output Format

## ***Enable Output Format***

This is a global enable/disable parameter. Use **Set Number of Symbols** and **Output Phrase** to assign symbols for formatting, and **Symbol Parse** to determine the specific output content for the assigned symbols.

On the **Output Format** tab, check the **Enable Output Format** box.

Video Evaluation Calibration WOI Configuration Database Ordered Output **Output Format** Dynamic Setup

Enable Output Format  Auto Sync with Reader

Set Number of Symbols: 1

**Output Phrase**

Preamble:   Enable

Symbol #1:   Parse

Postamble:   Enable

Parse Symbols... Send and Save Receive Quality Parameters...

▶ Show Parse Table

## Set Number of Symbols

**Number of Symbols** determines the number of symbols to which output formatting will apply.

## Output Phrase

**Output Phrase** refers to the user-defined Preamble, selected symbols, and Postamble sequence in the read cycle result.

Enable Output Format

Set Number of Symbols: 5

Use the **Set Number of Symbols** spin box to determine the number of symbols to be included in the output phrase.

**Output Phrase**

Preamble:	Symbol #1	Symbol Separator:	Symbol #2	Symbol #3	Symbol #4	Symbol #5	Postamble:
CR		,					CR LF
<input checked="" type="checkbox"/> Enable	<input checked="" type="checkbox"/> Parse		<input checked="" type="checkbox"/> Parse	<input checked="" type="checkbox"/> Parse	<input type="checkbox"/> Parse	<input type="checkbox"/> Parse	<input checked="" type="checkbox"/> Enable

Enter **Postamble** characters by double-clicking in the text field and then using the Postamble calculator.

Check the **Parse** boxes beneath the symbols to be formatted.

Enter **Postamble** characters by double-clicking in the text field and then using the Postamble calculator.

**Preamble**

CR

SOH	STX	ETX	EOT	ENQ
ACK	BEL	BS	HT	LF
VT	FF	CR	SO	SI
SI	DC1	DC2	DC3	DC4
NAK	SYN	ETB	CAN	EM
SUB	ESC	FS	GS	RS
US	SP			

Click 'Delete' to remove characters.

OK Cancel

**Postamble**

CR LF

SOH	STX	ETX	EOT	ENQ
ACK	BEL	BS	HT	LF
VT	FF	CR	SO	SI
SI	DC1	DC2	DC3	DC4
NAK	SYN	ETB	CAN	EM
SUB	ESC	FS	GS	RS
US	SP			

Click 'Delete' to remove characters.

OK Cancel

# Symbol Parse

## Extract

Parse Symbols... Send and Save Receive Quality Parameters...

▼ Hide Parse Table

Build Sequence: Test

Step	Insert Data	Extract Range
Extract		2 - 4

Sample Symbol:  
Original: ABCDEFGHIJKLMNOPQRSTUVWXYZ0123456789  
Output: BCD

**Symbol Parse**

Step	Insert Data	Extract Range
Extract		2 - 4

Add Insert Step Add Extract Step

Remove Step Clear All Parsing

Sample Symbol:  
Original: ABCDEFGHIJKLMNOPQRSTUVWXYZ0123456789  
Output: BCD

OK Cancel

The **Extract Range** function corresponds to the **Start Location** and **Length** parameters in the **Format Extract** serial command.

Multiple character sequences can be extracted and inserted using **Symbol Parse**. In this example, the selected extraction range is characters 2-4. The "Sample Symbol" example on the **Symbol Parse** dialog shows the selected character positions extracted and output as desired. Simultaneously, the data string from the selected symbol is displayed at the bottom left of the **Parse Table**, followed by the user-defined extracted output.

# Insert

Step	Insert Data	Extract Range
Insert		

Buttons: Add Insert Step, Add Extract Step, Remove Step, Clear All Parsing

Sample Symbol:  
Original: ABCDEFGHIJKLMNOPQRSTUVWXYZ0123456789  
Output:

Buttons: OK, Cancel

SP SP

SOH	STX	ETX	EOT	ENQ
ACK	BEL	BS	HT	LF
VT	FF	CR	SO	SI
DC1	DC2	DC3	DC4	
NAK	SYN	ETB	CAN	EM
SUB	ESC	FS	GS	RS
US	SP			

Click 'Delete' to remove characters.

Buttons: OK, Cancel

The **Insert** process is very similar to the **Extract** process, except that **Insert** allows the user to enter characters using the **Insert** calculator (shown above).

Buttons: Parse Symbols..., Send and Save, Receive, Quality Parameters...

▼ Hide Parse Table

Build Sequence: Test

Step	Insert Data	Extract Range
Insert	SP SP	
Extract		3 - 5

Notice that **Extract** and **Insert** share the same **Parse Table**.

Sample Symbol:  
Original: ABCDEFGHIJKLMNOPQRSTUVWXYZ0123456789  
Output: CDE

Buttons: Add Insert Step, Add Extract Step, Remove Step, Clear All Parsing

Sample Symbol:  
Original: ABCDEFGHIJKLMNOPQRSTUVWXYZ0123456789  
Output: CDE

Buttons: OK, Cancel

## Dynamic Setup

**Dynamic Setup** is used to calculate image capture timing during a read cycle. Without proper timing, the imager will not be able to decode all symbols in a read cycle. An external trigger is used to activate image captures so the user can make timing adjustments as capture events occur.

The user can control **Capture #**, **Number of Captures**, and **Number of Symbols** using these spin boxes.

**Read Rate** is represented graphically in real-time as the user makes adjustments to the time delay between image captures.

Capture #: 1  
 Number of Captures: 1  
 Number of Symbols: 1

Delay (Sec): 0.078432  
 Delay Adjustment:  Coarse  Medium  Fine

Decrease [Slider] Increase

The **Delay Adjustment** slider allows the user extremely precise control of the time delays between image captures in a read cycle. Delay values are shown in seconds in the field above the slider. The **Coarse** and **Fine Delay Adjustment** options determine whether larger or smaller adjustment increments will be used.





# 5 Parameters

## Contents

Communication .....	5-2
Read Cycle .....	5-42
Symbologies .....	5-62
I/O Parameters.....	5-98
Symbol Quality.....	5-159
Matchcode .....	5-166
Diagnostics .....	5-175

This section explains the function and purpose of the **Parameters** commands in ESP's tabbed tree controls.

**Important:** Unless otherwise specified, command settings shown in this section are the default settings.

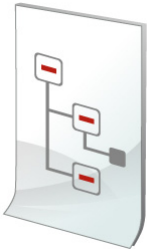

# Communication

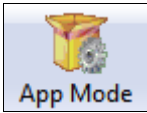

Click the **App Mode** button and then the **Parameters** button to display the tree control tabs.  
Then click the **Communication** tab to display the Communication tree control.

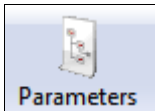

Parameters	ESP Values
[-] Communications	
[+] RS232 A	
[+] RS232 B	Enabled
[+] RS422	Disabled
[+] Ethernet	Enabled
[+] Protocol Selection	Point-to-Point
[+] External Data Routing	Disabled
[+] Array Communication Modes	Disabled
[+] Preamble	Disabled
[+] Postamble	Enabled*
	Disabled
	Enabled*

The \* indicates that the setting is the default.

To open nested options, **single-click** the +.

To change a setting, **double-click** the setting and use the cursor to scroll through the options.

**Note:** Communication settings can also be sent to the imager from ESP's Terminal using Microscan's K command format. Refer to the **Communication** section of **Appendix E**.



## Port Routing

The QX Hawk features a communication system based on **Port Routing** instead of traditional, dedicated serial ports. Decisions can be made about the direction and content of communication between ports based on different **Data Types**. Any available port can be used in any combination.

The fundamental concept of Port Routing is that communication design can be based upon Data Types rather than ports. The advantage of this is the ability to map different data types to different ports—the user is no longer limited to a “Host Port” and “Aux Port” for specific types of input and output. Since each port is independent instead of fixed for a particular purpose, the imager behaves more like a data switch.

### Standard QX Hawk

Primary	Secondary	Port Routing
<b>Command Data</b> <input checked="" type="checkbox"/> RS232 A <input checked="" type="checkbox"/> RS232 B <input checked="" type="checkbox"/> RS422 <input checked="" type="checkbox"/> TCP Port 1 <input checked="" type="checkbox"/> TCP Port 2 <input type="checkbox"/> EtherNet/IP		Command Data →  ← Symbol Data Extended Data Diagnostic Data
<b>Symbol Data</b> <input checked="" type="checkbox"/> RS232 A <input checked="" type="checkbox"/> RS232 B <input type="checkbox"/> RS422 <input checked="" type="checkbox"/> TCP Port 1 <input checked="" type="checkbox"/> TCP Port 2 <input checked="" type="checkbox"/> EtherNet/IP		
<input type="button" value="Send Settings"/> <input type="button" value="Send and Save"/>		

Primary	Secondary	Port Routing								
<b>Extended Data</b> <input checked="" type="checkbox"/> RS232 A <input checked="" type="checkbox"/> RS232 B <input type="checkbox"/> RS422 <input checked="" type="checkbox"/> TCP Port 1 <input checked="" type="checkbox"/> TCP Port 2 <input checked="" type="checkbox"/> EtherNet/IP		<table border="1"> <tr><td>Extended Data</td><td></td></tr> <tr><td><input type="checkbox"/> Database Identifier Output</td><td></td></tr> <tr><td><input type="checkbox"/> Read Duration Output</td><td></td></tr> <tr><td><input type="checkbox"/> Symbology Identifier</td><td></td></tr> </table>	Extended Data		<input type="checkbox"/> Database Identifier Output		<input type="checkbox"/> Read Duration Output		<input type="checkbox"/> Symbology Identifier	
Extended Data										
<input type="checkbox"/> Database Identifier Output										
<input type="checkbox"/> Read Duration Output										
<input type="checkbox"/> Symbology Identifier										
<b>Diagnostic Data</b> <input checked="" type="checkbox"/> RS232 A <input checked="" type="checkbox"/> RS232 B <input type="checkbox"/> RS422 <input checked="" type="checkbox"/> TCP Port 1 <input checked="" type="checkbox"/> TCP Port 2		<table border="1"> <tr><td>Diagnostic Data</td><td></td></tr> <tr><td><input type="checkbox"/> Service Status</td><td></td></tr> </table>	Diagnostic Data		<input type="checkbox"/> Service Status					
Diagnostic Data										
<input type="checkbox"/> Service Status										
<input type="button" value="Send Settings"/> <input type="button" value="Send and Save"/>										

### QX Hawk C-Mount

Primary	Secondary	Port Routing
<b>Command Data</b> <input checked="" type="checkbox"/> RS232 A <input checked="" type="checkbox"/> RS232 B <input checked="" type="checkbox"/> RS422 <input checked="" type="checkbox"/> TCP Port 1 <input checked="" type="checkbox"/> TCP Port 2 <input type="checkbox"/> EtherNet/IP		Command Data →  ← Symbol Data Extended Data Diagnostic Data
<b>Symbol Data</b> <input checked="" type="checkbox"/> RS232 A <input checked="" type="checkbox"/> RS232 B <input type="checkbox"/> RS422 <input checked="" type="checkbox"/> TCP Port 1 <input checked="" type="checkbox"/> TCP Port 2 <input checked="" type="checkbox"/> EtherNet/IP		
<input type="button" value="Send Settings"/> <input type="button" value="Send and Save"/>		

Primary	Secondary	Port Routing								
<b>Extended Data</b> <input checked="" type="checkbox"/> RS232 A <input checked="" type="checkbox"/> RS232 B <input type="checkbox"/> RS422 <input checked="" type="checkbox"/> TCP Port 1 <input checked="" type="checkbox"/> TCP Port 2 <input checked="" type="checkbox"/> EtherNet/IP		<table border="1"> <tr><td>Extended Data</td><td></td></tr> <tr><td><input type="checkbox"/> Database Identifier Output</td><td></td></tr> <tr><td><input type="checkbox"/> Read Duration Output</td><td></td></tr> <tr><td><input type="checkbox"/> Symbology Identifier</td><td></td></tr> </table>	Extended Data		<input type="checkbox"/> Database Identifier Output		<input type="checkbox"/> Read Duration Output		<input type="checkbox"/> Symbology Identifier	
Extended Data										
<input type="checkbox"/> Database Identifier Output										
<input type="checkbox"/> Read Duration Output										
<input type="checkbox"/> Symbology Identifier										
<b>Diagnostic Data</b> <input checked="" type="checkbox"/> RS232 A <input checked="" type="checkbox"/> RS232 B <input type="checkbox"/> RS422 <input checked="" type="checkbox"/> TCP Port 1 <input checked="" type="checkbox"/> TCP Port 2		<table border="1"> <tr><td>Diagnostic Data</td><td></td></tr> <tr><td><input type="checkbox"/> Service Status</td><td></td></tr> </table>	Diagnostic Data		<input type="checkbox"/> Service Status					
Diagnostic Data										
<input type="checkbox"/> Service Status										
<input type="button" value="Send Settings"/> <input type="button" value="Send and Save"/>										

## **Port Routing Advantages**

- Data can be routed in on one port and out on the same port or a different port like a switch or router. **Transparent Mode**, **Half Duplex Mode**, **Full Duplex Mode**, and **Custom Mode**.
- External Data Routing still follows the “To/From Host/Aux” paradigm. The new capability allows the customer to define the data direction—which port behaves as the “Host Port” and which port behaves as the “Aux Port”.
- Only one daisy chain setup required per system.
- Minimal configuration required for each port, with similar items grouped together.

## RS-232 A

The following settings define the basic transmission speeds and digital standards that ensure common RS-232 formatting.

R5232 A	
Baud Rate	115.2K
Parity	None
Stop Bits	One
Data Bits	Eight
Symbol Data Output	Enabled
Extra Symbol Information	Enabled
Diagnostics Output	Enabled
External Source Processing Mode	Command

### Baud Rate

Can be used to transfer data faster or to match host port settings.

The rate at which the imager and host transfer data back and forth.

Baud Rate	115.2K*
	600
	1200
	2400
	4800
	9600
	19.2K
	38.4K
	57.6K
	115.2K*

### Parity

Only changed if necessary to match host setting.

An error detection routine in which one data bit per character is set to **1** or **0** so that the total number of bits in the data field is either even or odd.

Parity	None*
	None*
	Even
	Odd

### Stop Bits

Only changed if necessary to match host setting.

One or two bits added to the end of each character to indicate the end of the character.

Stop Bits	One*
	One*
	Two

### Data Bits

Only changed if necessary to match host setting.

One or two bits added to the end of each character to indicate the end of the character.

Data Bits	Eight*
	Seven
	Eight*

### Symbol Data Output

Enables or disables decoded symbol data output from the imager.

Symbol Data Output	Enabled*
	Disabled
	Enabled*

### Extended Data

Enables or disables extra symbol information output from the imager.

Extra Symbol Information	Enabled*
	Disabled
	Enabled*

### Diagnostics Output

Enables or disables diagnostics output from the imager.

Diagnostics Output	Enabled*
	Disabled
	Enabled*

## External Source Processing Mode

Enables or disables processing of commands or data from sources external to the imager.

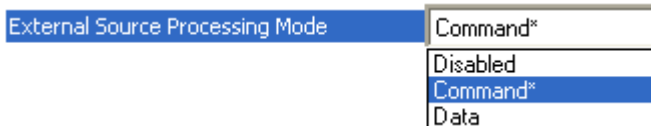

### **Command**

**Command** enables command processing in the imager.

**Note:** Command processing is always enabled for **RS-232 A**.

### **Data**

**Data** enables RS-232 A as a data source port.

**Note:** The data path between **in** the source port and **out** the source port is always two-way. Data is copied from source data ports and all those source ports' data is transmitted to the destination port, and from the destination port to the source port.

## RS-232 B

The following settings define the basic transmission speeds and digital standards that ensure common RS-232 formatting.

<input type="checkbox"/> RS232 B	Enabled
Baud Rate	115.2K
Parity	None
Stop Bits	One
Data Bits	Eight
Symbol Data Output	Enabled
Extra Symbol Information	Enabled
Diagnostics Output	Enabled
External Source Processing Mode	Command

### Baud Rate

Can be used to transfer data faster or to match host port settings.  
The rate at which the imager and host transfer data back and forth.

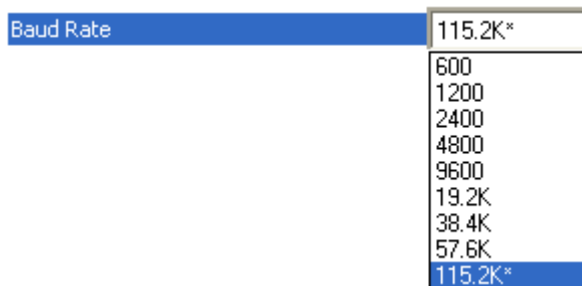

### Parity

Only changed if necessary to match host setting.  
An error detection routine in which one data bit per character is set to **1** or **0** so that the total number of bits in the data field is either even or odd.



### Stop Bits

Only changed if necessary to match host setting.  
One or two bits added to the end of each character to indicate the end of the character.



## Data Bits

Only changed if necessary to match host setting.

One or two bits added to the end of each character to indicate the end of the character.

Data Bits	Eight*
	Seven
	Eight*

## Symbol Data Output

Enables or disables decoded symbol data output from the imager.

Symbol Data Output	Enabled*
	Disabled
	Enabled*

## Extended Data

Enables or disables extra symbol information output from the imager.

Extra Symbol Information	Enabled*
	Disabled
	Enabled*

## Diagnostics Output

Enables or disables diagnostics output from the imager.

Diagnostics Output	Enabled*
	Disabled
	Enabled*

## External Source Processing Mode

Enables or disables processing of commands or data from sources external to the imager.

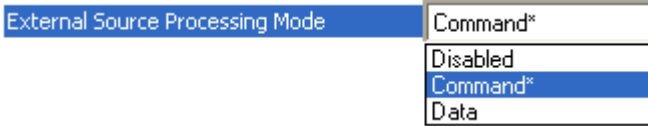

### **Command**

**Command** enables command processing in the imager.

### **Data**

**Data** enables RS-232 B as a data source port.

**Note:** The data path between **in** the source port and **out** the source port is always two-way. Data is copied from source data ports and all those source ports' data is transmitted to the destination port, and from the destination port to the source port.



## RS-422

The following settings define the basic transmission speeds and digital standards that ensure common RS-422 formatting.

<input type="checkbox"/> RS422	Disabled
Baud Rate	115.2K
Parity	None
Stop Bits	One
Data Bits	Eight
Symbol Data Output	Disabled
Extra Symbol Information	Disabled
Diagnostics Output	Disabled
External Source Processing Mode	Command

### Baud Rate

Can be used to transfer data faster or to match host port settings.

The rate at which the imager and host transfer data back and forth.

Baud Rate	115.2K*
	600
	1200
	2400
	4800
	9600
	19.2K
	38.4K
	57.6K
	115.2K*

### Parity

Only changed if necessary to match host setting.

An error detection routine in which one data bit per character is set to **1** or **0** so that the total number of bits in the data field is either even or odd.

Parity	None*
	None*
	Even
	Odd

### Stop Bits

Only changed if necessary to match host setting.

One or two bits added to the end of each character to indicate the end of the character.

Stop Bits	One*
	One*
	Two

### Data Bits

Only changed if necessary to match host setting.

One or two bits added to the end of each character to indicate the end of the character.

Data Bits	Eight*
	Seven
	Eight*

### Symbol Data Output

Enables or disables decoded symbol data output from the imager.

Symbol Data Output	Enabled*
	Disabled
	Enabled*

### Extended Data

Enables or disables extra symbol information output from the imager.

Extra Symbol Information	Enabled*
	Disabled
	Enabled*

### Diagnostics Output

Enables or disables diagnostics output from the imager.

Diagnostics Output	Enabled*
	Disabled
	Enabled*

## External Source Processing Mode

Enables or disables processing of commands or data from sources external to the imager.

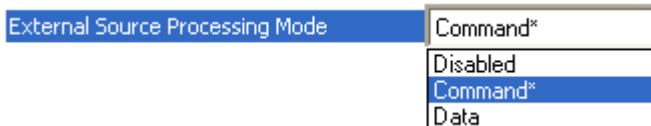

### **Command**

**Command** enables command processing in the imager.

### **Data**

**Data** enables RS-422 as a data source port.

**Note:** The data path between **in** the source port and **out** the source port is always two-way. Data is copied from source data ports and all those source ports' data is transmitted to the destination port, and from the destination port to the source port.

## Ethernet

Enables or disables Ethernet connectivity in the imager.

**Important:** For further information about setting up TCP/IP with a PC, see [Configuring Ethernet TCP/IP](#).

[-] Ethernet	Enabled
... IP Address	192.168.0.100
... Subnet	255.255.0.0
... Gateway	0.0.0.0
... IP Address Mode	Static
[-] TCP Port 1	2001
... Symbol Data Output	Enabled
... Extra Symbol Information	Enabled
... Diagnostics Output	Enabled
... External Source Processing Mode	Command
[-] TCP Port 2	2003
... Symbol Data Output	Enabled
... Extra Symbol Information	Enabled
... Diagnostics Output	Enabled
... External Source Processing Mode	Command

## IP Address

Enter the IP address of the imager in this field.

[-] Ethernet	Enabled
IP Address	192.168.0.100
Subnet	255.255.0.0
Gateway	0.0.0.0
IP Address Mode	Static
[-] TCP Port 1	2001
Symbol Data Output	Enabled
Extra Symbol Information	Enabled
Diagnostics Output	Enabled
External Source Processing Mode	Command
[-] TCP Port 2	2003
Symbol Data Output	Enabled
Extra Symbol Information	Enabled
Diagnostics Output	Enabled
External Source Processing Mode	Command

## Subnet

Enter the Subnet address of the imager in this field.

<input type="checkbox"/> Ethernet	Enabled
IP Address	192.168.0.100
Subnet	255.255.0.0
Gateway	U.U.U.U
IP Address Mode	Static
<input type="checkbox"/> TCP Port 1	2001
Symbol Data Output	Enabled
Extra Symbol Information	Enabled
Diagnostics Output	Enabled
External Source Processing Mode	Command
<input type="checkbox"/> TCP Port 2	2003
Symbol Data Output	Enabled
Extra Symbol Information	Enabled
Diagnostics Output	Enabled
External Source Processing Mode	Command

## Gateway

Enter the Gateway address of the imager in this field.

[-] Ethernet	Enabled
IP Address	192.168.0.100
Subnet	255.255.0.0
Gateway	0 . 0 . 0 . 0
IP Address Mode	Static
[-] TCP Port 1	2001
Symbol Data Output	Enabled
Extra Symbol Information	Enabled
Diagnostics Output	Enabled
External Source Processing Mode	Command
[-] TCP Port 2	2003
Symbol Data Output	Enabled
Extra Symbol Information	Enabled
Diagnostics Output	Enabled
External Source Processing Mode	Command

## IP Address Mode

Determines how the imager's IP address will be defined.

[-] Ethernet	Enabled
IP Address	192.168.0.100
Subnet	255.255.0.0
Gateway	0.0.0.0
IP Address Mode	Static*
[-] TCP Port 1	Static*
Symbol Data Output	DHCP
Extra Symbol Information	Enabled
Diagnostics Output	Enabled
External Source Processing Mode	Command
[-] TCP Port 2	2003
Symbol Data Output	Enabled
Extra Symbol Information	Enabled
Diagnostics Output	Enabled
External Source Processing Mode	Command

### **Static**

In **Static Mode**, the imager uses the user-defined IP address entered in ESP.

### **DHCP**

In **DHCP Mode**, the imager automatically acquires the IP address, Subnet, and Gateway addresses from a DHCP or BOOTP server.



## TCP Port 1

One of two TCP ports for Ethernet communication with the imager. The default setting is **2001**.

**Important:** Due to the nature of Ethernet communications, full messages are not necessarily contained within a single packet. It is recommended that you frame the data with a known start and stop (STX, ETX) to ensure successful message transmission.

[-] Ethernet	Enabled
IP Address	192.168.0.100
Subnet	255.255.0.0
Gateway	0.0.0.0
IP Address Mode	Static
[-] TCP Port 1	2001 1024 - 65535
Symbol Data Output	Enabled
Extra Symbol Information	Enabled
Diagnostics Output	Enabled
External Source Processing Mode	Command
[-] TCP Port 2	2003
Symbol Data Output	Enabled
Extra Symbol Information	Enabled
Diagnostics Output	Enabled
External Source Processing Mode	Command

### **Symbol Data Output**

Enables or disables decoded symbol data output from the imager.

### **Extended Data**

Enables or disables extra symbol information output from the imager.

### **Diagnostics Output**

Enables or disables diagnostics output from the imager.

### **External Source Processing Mode**

Enables or disables processing of commands or data from sources external to the imager.

### **Command**

**Command** enables command processing in the imager.

### **Data**

**Data** enables Ethernet TCP Port 1 as a data source port.

**Note:** The data path between **in** the source port and **out** the source port is always two-way. Data is copied from source data ports and all those source ports' data is transmitted to the destination port, and from the destination port to the source port.

## TCP Port 2

One of two TCP ports for Ethernet communication with the imager. The default setting is **2003**.

**Important:** Due to the nature of Ethernet communications, full messages are not necessarily contained within a single packet. It is recommended that you frame the data with a known start and stop (STX, ETX) to ensure successful message transmission.

[-] Ethernet	Enabled	
IP Address	192.168.0.100	
Subnet	255.255.0.0	
Gateway	0.0.0.0	
IP Address Mode	Static	
[-] TCP Port 1	2001	
Symbol Data Output	Enabled	
Extra Symbol Information	Enabled	
Diagnostics Output	Enabled	
External Source Processing Mode	Command	
[-] TCP Port 2	2003	1024 - 65535
Symbol Data Output	Enabled	
Extra Symbol Information	Enabled	
Diagnostics Output	Enabled	
External Source Processing Mode	Command	

### **Symbol Data Output**

Enables or disables decoded symbol data output from the imager.

### **Extended Data**

Enables or disables extra symbol information output from the imager.

### **Diagnostics Output**

Enables or disables diagnostics output from the imager.

### **External Source Processing Mode**

Enables or disables processing of commands or data from sources external to the imager.

### **Command**

**Command** enables command processing in the imager.

### **Data**

**Data** enables Ethernet TCP Port 2 as a data source port.

**Note:** The data path between **in** the source port and **out** the source port is always two-way. Data is copied from source data ports and all those source ports' data is transmitted to the destination port, and from the destination port to the source port.

## Search and Configure Mode

Search and Configure Mode	Enabled*
	Disabled
	Enabled*
	Timed Window

**Search and Configure Mode** is intended primarily for initial setup of a QX Hawk in a network. This parameter controls whether or not the QX Hawk will respond to ESP's **Search** function in the Ethernet TCP/IP connect dialog section of the **Connection Wizard**:

Name	IP Address	MAC ID
	10.10.4.132	00:0B:43:0F:6B:6B

After the QX Hawk is in full use in an application, you may want the imager to continue to appear in the **Search** response list for future searches. This can help prevent disruption of the system that may occur if ESP were to show only unconfigured units.

Changes to this parameter are saved to NOVRAM and are set to default on power on.

A Reset **<A>** is required for settings to take effect.

**Important:** Once this setting is Disabled, ESP will only be able to connect to the imager if you know the IP address and enter it in the IP Address field of the Ethernet TCP/IP connect dialog. Search and Configure Mode can be re-enabled by defaulting the QX Hawk.

### **Enabled**

When enabled, **Search and Configure Mode** will find the imager and settings can be changed.

### **Timed Window**

When **Timed Window** is selected, Search and Configure Mode will find the imager and settings can be changed, but only 60 seconds from the last reset. After 60 seconds, Search and Configure Mode will be disabled.

## Protocol Selection

In general, the point-to-point protocols will work well in most applications. They require no address and must use RS-232 or RS-422 communication standards.

Protocols define the sequence and format in which information is transferred between the imager and the host, or in the case of **Multidrop**, between the imagers and a concentrator.

**Note:** In all protocol modes, the **Preamble** and **Postamble** character strings can be used to frame the decoded data, and both are included in calculating the **LRC** (Longitudinal Redundancy Check).

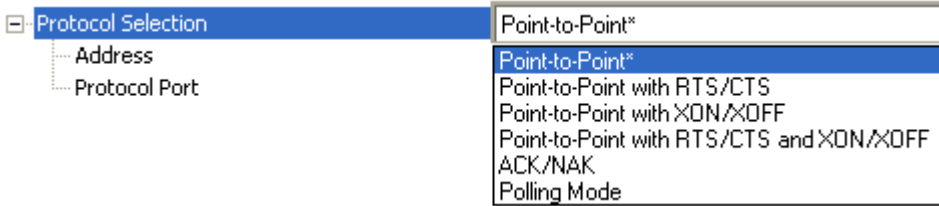

## Protocol Options

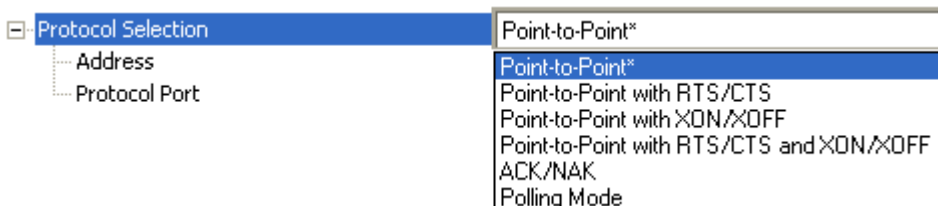

### ***Point-to-Point (Standard)***

Used only with RS-232 or RS-422.

Standard **Point-to-Point** requires no address and sends the data to the host whenever it is available, without a request or handshake from the host.

### ***Point-to-Point with RTS/CTS***

A scanner initiates a data transfer with an RTS (request-to-send) transmission. The host, when ready, responds with a CTS (clear-to-send) and the data is transmitted. RTS and CTS signals are transmitted over two dedicated wires as defined in the RS-232 standard. Used only with RS-232.

**Point-to-Point with RTS/CTS** (request-to-send/clear-to-send) is a simple hardware handshake protocol that allows a scanner to initiate data transfers to the host.

### ***Point-to-Point with XON/XOFF***

If an XOFF has been received from the host, data will not be sent to the host until the host sends an XON. During the XOFF phase, the host is free to carry on other chores and accept data from other devices. Used only with RS-232.

This option enables the host to send the XON and XOFF command as a single byte transmission command of start (**^Q**) or stop (**^S**).

### ***Point-to-Point with RTS/CTS and XON/XOFF***

Used only with RS-232.

This option is a combination of **Point-to-Point with RTS/CTS** and **Point-to-Point with XON/XOFF**.

### ***ACK/NAK***

See [ACK / NAK Options](#).

### ***Polling Mode***

See [Polling Mode Options](#).

## Address

The **Protocol Address** can be any number between **1** and **50**.

[-] Protocol Selection	Point-to-Point
Address	1 (1-50)
Protocol Port	RS232 A
[-] ACK / NAK Options	
RES	NUL
REQ	NUL
STX	NUL
ETX	NUL
ACK	ACK
NAK	NAK
[-] Polling Mode Options	
RES	EOT
REQ	ENQ
STX	STX
ETX	ETX
ACK	ACK
NAK	NAK
Response Timeout	5
LRC Status	Disabled

## Protocol Port

**RS-232 A** or **RS-422** can be used as **Protocol Ports**.

[-] Protocol Selection	Point-to-Point
Address	1
Protocol Port	RS232 A*
[-] ACK / NAK Options	
RES	RS232 A*
REQ	RS422
STX	NUL
ETX	NUL
ACK	NUL
NAK	ACK
[-] Polling Mode Options	
RES	ACK
REQ	NAK
STX	EOT
ETX	ENQ
ACK	STX
NAK	ETX
Response Timeout	ACK
LRC Status	NAK

## ACK / NAK Options

These parameters take effect for **ACK/NAK** on the main RS-232 or RS-422 ports (not on the Auxiliary Port), and are completely independent of the **Polling Mode Options**.

The imager always follows the protocol in both directions (to and from the host). There is no option to disable it from either direction.

<input type="checkbox"/> Protocol Selection	Point-to-Point
Address	1
Protocol Port	RS232 A
<input type="checkbox"/> ACK / NAK Options	
RES	NUL
REQ	NUL
STX	NUL
ETX	NUL
ACK	ACK
NAK	NAK
<input type="checkbox"/> Polling Mode Options	
RES	EOT
REQ	ENQ
STX	STX
ETX	ETX
ACK	ACK
NAK	NAK
Response Timeout	5
LRC Status	Disabled

### RES-NAK Defaults

<i>RES: (Reset)</i>	NUL (0x00)
<i>REQ: (Request)</i>	NUL (0x00)
<i>STX: (Start of Text)</i>	NUL (0x00)
<i>ETX: (End of Text)</i>	NUL (0x00)
<i>ACK: (Acknowledge)</i>	ACK (0x06)
<i>NAK: (Negative Acknowledge)</i>	NAK (0x15)

## **ACK/NAK Protocol**

The following are general outlines of the **ACK/NAK** protocol. Items that are framed by brackets ( [ ] ) can either be disabled or enabled. LRC does not include STX, but it does include preamble, postamble, and ETX.

### **Symbol Data Output**

**TX to host:** [STX] [preamble] SYMBOL DATA [postamble] [ETX] [LRC]

**Response from host:** ACK/NAK. Sent when LRC, ETX, postamble, or timeout (waiting for more data) are detected (if REQ is disabled) depending on what is enabled.

### **Commands from Host to Imager**

**TX to Imager:** [STX] <command> [ETX] [LRC]

**Response from Imager:** ACK/NAK. Sent when LRC, ETX, or command-ending angle bracket '>' are received, depending on what is enabled.

### **Command Response from Imager to Host**

**TX to host:** [STX] [preamble] COMMAND RESPONSE DATA [postamble] [ETX] [LRC]

**Response from host:** ACK/NAK. Sent when LRC, ETX, postamble, command-ending angle bracket '>', or timeout (waiting for more data) are detected, depending on what is enabled.

As with **Polling Mode <K140,5>**, the imager can optionally perform the REQ and RES event sequences in ACK/NAK mode. If the sender does not receive an ACK or NAK, it will send REQ to request such a response (if enabled). When the sender receives an ACK, too many NAKs, or times out (if already enabled), it will send a RES (if enabled) to terminate the transaction.

**Note:** See [ACK/NAK Data Flow Examples](#) in Appendix F for sample ACK/NAK communication scenarios.



## Polling Mode Options

These parameters only take effect for **Polling Mode <K140,5>** on the main RS-232 or RS-422 ports (not on the Auxiliary Port), and are completely independent of the **ACK/NAK Options <K147>**.

The values of protocol characters can be changed, but the protocol events cannot be disabled. The polling mode address is configured in the **<K140>** command.

To enable true multidrop protocol, the RS-422/485 port must be enabled, **<K102,1>**, in order to turn the transmitter on and off. If RS-232 is enabled instead of RS-422/485, **<K102,0>**, then **Polling Mode** will operate as a **Point-to-Point** polling protocol. This is because the RS-232 transmitter is always left on when enabled.

**Note:** See **ACK/NAK Data Flow Examples** in Appendix F for sample **Polling Mode** communication scenarios.

<input type="checkbox"/> Protocol Selection	Point-to-Point
Address	1
Protocol Port	RS232 A
<input type="checkbox"/> ACK / NAK Options	
RES	NUL
REQ	NUL
STX	NUL
ETX	NUL
ACK	ACK
NAK	NAK
<input type="checkbox"/> Polling Mode Options	
RES	EOT
REQ	ENQ
STX	STX
ETX	ETX
ACK	ACK
NAK	NAK
Response Timeout	5
LRC Status	Disabled

### RES-NAK Defaults

<i>RES: (Reset)</i>	EOT (0x04)
<i>REQ: (Request)</i>	ENQ (0x05)
<i>STX: (Start of Text)</i>	STX (0x02)
<i>ETX: (End of Text)</i>	ETX (0x03)
<i>ACK: (Acknowledge)</i>	ACK (0x06)
<i>NAK: (Negative Acknowledge)</i>	NAK (0x15)

## Response Timeout

Only used when a response is required from the host. While in **Multidrop**, if the imager does not receive an **ACK** or **NAK** from the host after sending polled data, it will act on a fault. The imager can be set to wait indefinitely by setting **Response Timeout** to zero.

The time that the imager will wait before timing out if **ACK**, **NAK**, and **ETX** are enabled, and a host response is expected.

<input type="checkbox"/> Protocol Selection	Point-to-Point
Address	1
Protocol Port	RS232 A
<input type="checkbox"/> ACK / NAK Options	
RES	NUL
REQ	NUL
STX	NUL
ETX	NUL
ACK	ACK
NAK	NAK
<input type="checkbox"/> Polling Mode Options	
RES	EOT
REQ	ENQ
STX	STX
ETX	ETX
ACK	ACK
NAK	NAK
Response Timeout	0.005 <input type="text"/> Seconds
LRC Status	Disabled

## LRC Status

Used when extra data integrity is required.

An error-checking routine that verifies the accuracy of transmissions. It is the exclusive OR of all characters following the **STX** (start of text) up to and including the **ETX** (end of text). What this means is that the binary representation of all the characters in a transmission are cumulatively added in a column and each resulting odd integer is assigned a 1 and each even integer a 0 (two 1s = 0, two 0s = 0, a 1 and a 0 = 1). The extra LRC character is then appended to the transmission, and the receiver (usually the host) performs the same addition and compares the results.

<input type="checkbox"/> Protocol Selection	Point-to-Point
Address	1
Protocol Port	R5232 A
<input type="checkbox"/> ACK / NAK Options	
RES	NUL
REQ	NUL
STX	NUL
ETX	NUL
ACK	ACK
NAK	NAK
<input type="checkbox"/> Polling Mode Options	
RES	EOT
REQ	ENQ
STX	STX
ETX	ETX
ACK	ACK
NAK	NAK
Response Timeout	5
LRC Status	Disabled*
	Disabled*
	Enabled

## External Data Routing

External Data Routing settings configure the global operation of all external data port settings.

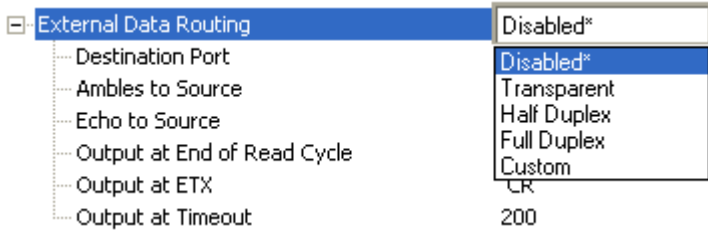

### External Data Routing Options

#### Transparent Mode

When **Transparent Mode** is enabled, the following conditions apply:

**Symbol Data to Source** = Fixed to **Enabled**

**Ambles to Source** = Fixed to **Disabled**

**Echo to Source** = Fixed to **Enabled**

**Output at End of Read Cycle** = Fixed to **Enabled**

**Output at ETX** = Fixed to **Enabled** with user-defined characters. Default character will be used if this setting is set to Disabled.

**Output at Timeout** = Fixed to **Enabled** with user-defined timeout. Default time will be used if this setting is set to Disabled.

## Mode of Operation

- Source Port data will echo back to itself.
- Source Port data will always pass through even when the Destination Port is in Polling Mode with the host.
- Whenever ETX is received on the Source Port or symbol data is generated, the data will be send to the Destination Port with its data appearing between the Preamble and symbol data.
- Source Port data will always be sent to the Destination Port with a Preamble and Postamble.
- Symbol data will be sent to the Source Port on a good read without Preamble or Postamble in Point-to-Point protocol even if the Destination Port is in Polling Mode with the host.
- Destination Port data always echoes to the Source Port even if the Destination Port is in Polling Mode.

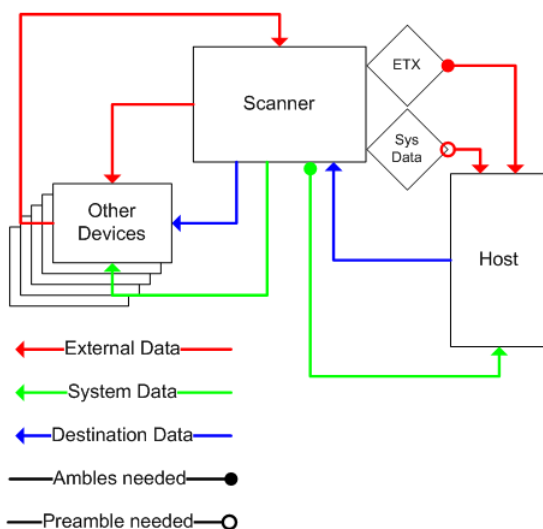

### Half Duplex Mode

When **Half Duplex Mode** is enabled, the following conditions apply:

**Symbol Data to Source** = Fixed to **Enabled**

**Ambles to Source** = Fixed to **Enabled**

**Echo to Source** = Fixed to **Disabled**

**Output at End of Read Cycle** = Fixed to **Disabled**

**Output at ETX** = Fixed to **Disabled** with user-defined characters. Default character will be used if this setting is set to Disabled.

**Output at Timeout** = Fixed to **Disabled** with user-defined timeout. Default time will be used if this setting is set to Disabled.

### Mode of Operation

- Source Port data is not echoed back to itself.
- Source Port data is ignored when the Destination Port is in Polling Mode.
- Source Port data or symbol data is sent to the Destination Port whenever it is received.
- Source Port data is sent to the Destination Port without a Preamble or Postamble.
- Symbol data is sent to the Source Port and the Destination Port at the same time, and conforms to the communication parameters.
- Destination Port data is echoed to the Source Port in an un-pollled mode.

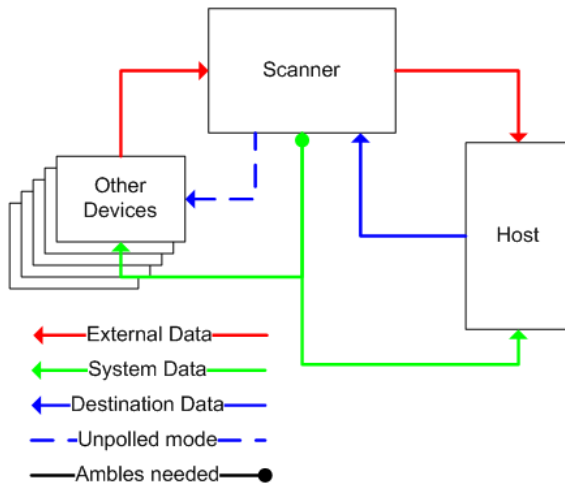

## Full Duplex Mode

When **Full Duplex Mode** is enabled, the following conditions apply:

**Symbol Data to Source** = Fixed to **Disabled**

**Ambles to Source** = Fixed to **Disabled**

**Echo to Source** = Fixed to **Disabled**

**Output at End of Read Cycle** = Fixed to **Disabled**

**Output at ETX** = Fixed to **Disabled** with user-defined characters. Default character will be used if this setting is set to Disabled.

**Output at Timeout** = Fixed to **Disabled** with user-defined timeout. Default time will be used if this setting is set to Disabled.

### Mode of Operation

- Source Port data is not echoed back to itself.
- Source Port data is ignored when the Destination Port is in Polling Mode.
- Source Port data or symbol data is sent to the Destination Port whenever it is received.
- Source Port data is always sent to the Destination Port without a Preamble or Postamble.
- Symbol data is not sent to the Source Port.
- Destination port data is echoed to the source port in an un-pollled mode.

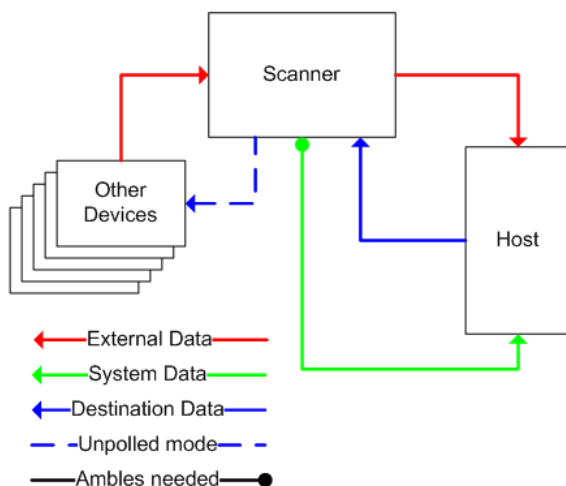

## Custom Mode

**Custom** allows for user-defined communication (Ambles to Source, Echo to Source, Output at End of Read Cycle, Output at ETX, Output at Timeout).

### Destination Port

Determines the port to which data will be sent.

External Data Routing	Disabled
Destination Port	RS232 A*
Ambles to Source	RS232 A*
Echo to Source	RS232 B
Output at End of Read Cycle	RS422
Output at ETX	TCP Port 1
Output at Timeout	TCP Port 2
	EtherNet/IP

### Ambles to Source

Enables or Disables the ability to send Preambles and Postambles to the Source port.

External Data Routing	Disabled
Destination Port	RS232 A
Ambles to Source	Disabled*
Echo to Source	Disabled*
Output at End of Read Cycle	Enabled
Output at ETX	CR
Output at Timeout	200

### Echo to Source

Enables or Disables the ability to send an Echo to the Source port.

External Data Routing	Disabled
Destination Port	RS232 A
Ambles to Source	Disabled
Echo to Source	Disabled*
Output at End of Read Cycle	Disabled*
Output at ETX	Enabled
Output at Timeout	200

### Output at End of Read Cycle

Enables or Disables the ability to output data at the end of read cycle.

External Data Routing	Disabled
Destination Port	RS232 A
Ambles to Source	Disabled
Echo to Source	Disabled
Output at End of Read Cycle	Disabled*
Output at ETX	Disabled*
Output at Timeout	Enabled



## Output at ETX

Determines the output at ETX.

<input type="checkbox"/> External Data Routing	Disabled
Destination Port	RS232 A
Ambles to Source	Disabled
Echo to Source	Disabled
Output at End of Read Cycle	Disabled
Output at ETX	
Output at Timeout	

NUL	SOH	STX	ETX	EOT	ENQ
ACK	BEL	BS	HT	LF	VT
FF	CR	SO	SI	DLE	DC1
DC2	DC3	DC4	NAK	SYN	ETB
CAN	EM	SUB	ESC	FS	GS
RS	US	SP			

Click 'Delete' to remove characters.

## Output at Timeout

Determines the Timeout value for output.

<input type="checkbox"/> External Data Routing	Disabled
Destination Port	RS232 A
Ambles to Source	Disabled
Echo to Source	Disabled
Output at End of Read Cycle	Disabled
Output at ETX	CR
Output at Timeout	0.200 <input type="text" value="÷"/> Seconds

## Array Communication Modes

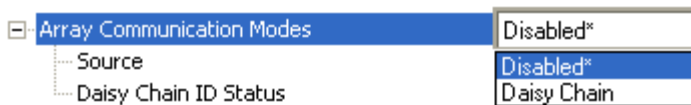

### Mode

#### Daisy Chain

When set to **Daisy Chain**, follows Microscan Daisy Chain protocol.

**Note:** Daisy Chain can also be autoconfigured by sending the **Daisy Chain Autoconfigure** serial command.

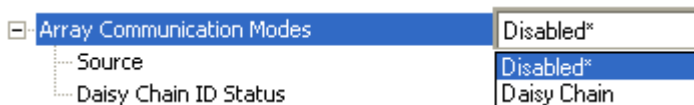

### Source

Defines the communication port.

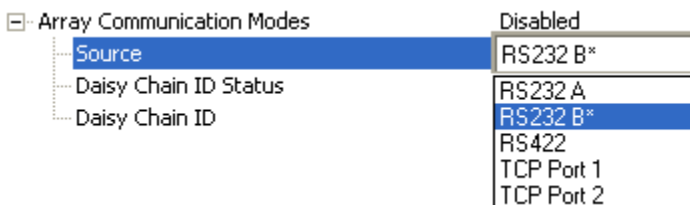

### Daisy Chain ID Status

When enabled, the imager will append a two-character prefix to each imager in the array. This allows the user to identify which imager sent the data.

**Note:** Daisy Chain ID will automatically disable Symbol Data Output, Extended Data, and Diagnostics Output for the Source Port.

Symbol Data Output will be automatically enabled, Extended Data will be automatically enabled, and Diagnostics Output will be automatically disabled for the Destination Port.

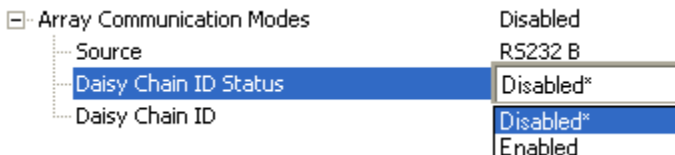

## Daisy Chain ID

The **Daisy Chain ID** is a two-character identifier.

- [-] Array Communication Modes      Disabled
  - Source                                  RS232 B
  - Daisy Chain ID Status              Disabled
  - Daisy Chain ID

1 /					
NUL	SOH	STX	ETX	EOT	ENQ
ACK	BEL	BS	HT	LF	VT
FF	CR	SO	SI	DLE	DC1
DC2	DC3	DC4	NAK	SYN	ETB
CAN	EM	SUB	ESC	FS	GS
RS	US	SP			
Click 'Delete' to remove characters.					

## Daisy Chain Autoconfigure

For quick setup of a daisy chain configuration.

The command to **Autoconfigure** the daisy chain is sent to the primary imager and the software responds in the following ways:

- Counts the number of secondary imagers in the daisy chain.
- Assigns an internal ID number (1...n) to each secondary imager, where the first secondary imager is number **1** (the primary imager's ID being a **0**).
- Propagates the communication settings and the relevant operating modes of the primary imager to the ports of each secondary imager.
- Resets each secondary imager.
- Confirms that each secondary imager has acquired the new settings.

**When setting up a daisy chain operation, perform the following steps:**

1. Set the primary imager (the one connected to the host) to **Serial Data** Trigger Mode. This will also set all the imagers in the chain to **Serial Data** when the command is executed.

**Important:** All secondary imagers must be set to **Serial Data** Trigger Mode for **Daisy Chain** to function.

Before **Autoconfigure**, the primary imager must be set to **Serial (S)**:

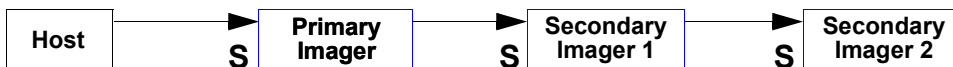

2. Send the **<K150DAISY>** command from ESP's Terminal.
3. If necessary, set the primary imager to **External Edge**.

After **Autoconfigure**, the primary imager can be set to **External Edge (E)**, but the other imagers must remain in **Serial (S)**:

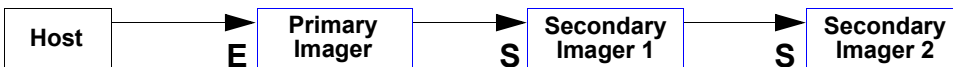

### Pre-Setup Requirements:

1. Start setup by matching the communication settings of the “downstream” port of the primary imager to the “upstream” ports of the secondary imagers. It may be necessary to set up all the “upstream” ports first so the chain can pass information.
2. “Downstream” ports on secondary imagers will be set up automatically during the setup process.
3. If the imager is Ethernet-enabled, first check to determine if **RS-232 B** is available. If it is available, set RS-232 B as the **Source** port in **Array Communication Modes**. Otherwise, set RS-232 A as the Source port. Port Routing for Symbol Data Output and Extended Data will be disabled on the Source port.

## Daisy Chain Considerations

Settings for Number of Symbols and Timeout must be taken into consideration when setting up a daisy chain configuration. An example of a three-imager daisy chain configuration and the associated Number of Symbols and Timeout settings is shown here.

Sample setup of three imagers, each with one symbol in its field of view:

> Secondary Imager 2	> Secondary Imager 1	> Primary Imager	> Host
# of Symbols = 1	# of Symbols = 2	# of Symbols = 3	
Timeout = 100 ms	Timeout = 200 ms	Timeout = 300 ms	

### Number of Symbols

For each imager in the chain, the number of symbols set must equal the number of symbols in the current imager's own field of view plus the number of symbols in the previous imager's field of view. (The last imager in the chain – Secondary Imager 2 in this example – only needs to be set for the number of symbols in its own field of view, as there is no previous imager.)

For example, if there are three imagers and each imager has one symbol in its field of view, the number of symbols for each imager should be set as follows:

- Secondary Imager 2: # of Symbols = **1**
- Secondary Imager 1: # of Symbols = **2**
- Primary Imager: # of Symbols = **3**

If there are two symbols in Secondary Imager 2's field of view, one symbol in Secondary Imager 1's field of view, and two symbols in the Primary Imager's field of view, the number of symbols for each imager should be set as follows:

- Secondary Imager 2: # of Symbols = **2**
- Secondary Imager 1: # of Symbols = **3**
- Primary Imager: # of Symbols = **5**

### Timeout

The last imager in the chain passes its symbol data back in the direction of the host when its timeout expires. Each imager must have its timeout set to accommodate its own read time plus the read time of the previous imager.

For example, if it is determined that a maximum of 100 ms is adequate for each imager to decode its associated symbol(s), the timeout for each imager should be set as follows:

- Secondary Imager 2: Timeout = **100 ms**
- Secondary Imager 1: Timeout = **200 ms**
- Primary: Timeout = **300 ms**

## Preamble

Useful for identifying and controlling incoming data. For example, defining the preamble as a carriage return and a line feed causes each decoded message to be displayed on its own line.

Preamble Disabled  
    └─ Preamble Characters CR

## Preamble Characters

Allows the user to define up to four postamble characters that can be added to the end of the decoded data

Preamble Disabled  
    └─ Preamble Characters

CR

SOH	STX	ETX	EOT	ENQ	ACK
BEL	BS	HT	LF	VT	FF
CR	SO	SI	DLE	DC1	DC2
DC3	DC4	NAK	SYN	ETB	CAN
EM	SUB	ESC	FS	GS	RS
US	SP				

Click 'Delete' to remove characters.

## Postamble

Useful for identifying and controlling incoming data. For example, defining the postamble as a carriage return and a line feed causes each decoded message to be displayed on its own line.

Preamble Disabled  
     └─ Preamble Characters CR

## Postamble Characters

Allows the user to define up to four postamble characters that can be added to the end of the decoded data.

Postamble Enabled  
     └─ Postamble Characters

CR LF

SOH	STX	ETX	EOT	ENQ	ACK
BEL	BS	HT	LF	VT	FF
CR	SO	SI	DLE	DC1	DC2
DC3	DC4	NAK	SYN	ETB	CAN
EM	SUB	ESC	FS	GS	RS
US	SP				

Click 'Delete' to remove characters.

# Read Cycle

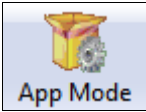

Click the **App Mode** button and then the **Parameters** button to display the tree control tabs.  
Then click the **Read Cycle** tab to display the Read Cycle tree control.

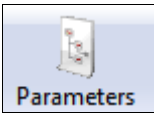

Parameters	ESP Values
[-] Read Cycle	
[+] Multisymbol	
[-] Trigger	
... Mode	Continuous Read
[-] Trigger Filter Duration	
... Leading Edge	313
... Trailing Edge	313
... External Trigger State	Active Closed*
[+] Serial Trigger	Active Open
... Decodes Before Output	Active Closed*
[+] End of Read Cycle	
[+] Capture Mode	Continuous
[+] Capture Time	
[+] Store No Read Image	
[-] Image Processing Settings	

The \* indicates that the setting is the default.

To open nested options, **single-click** the +.

To change a setting, **double-click** the setting and use the cursor to scroll through the options.

**Note:** Read Cycle settings can also be sent to the imager from ESP's Terminal using Microscan's K command format. Refer to the **Read Cycle** section of **Appendix E**.



## **Read Cycle Setup**

Setting up read cycle and triggering parameters involves a series of decisions based on the particular application, as follows:

1. Select the number of symbols to be read in a single cycle.
2. Decide on the trigger type to be used: if serial, choose a serial character; if external, choose either **External Level** or **External Edge**.
3. Designate how the read cycle should end (**Timeout**, **New Trigger**).

## Multisymbol

**Multisymbol** is commonly used in shipping applications where a shipping symbol contains individual symbols for part number, quantity, etc. This feature allows one trigger to pick up all the symbols.

Multisymbol allows the user to define up to 100 symbols that can be read in a single read cycle.

The following conditions apply:

- The maximum number of characters in a read cycle is 3,000 for all symbols.
- All No Read messages are posted at the end of the data string, unless output filtering is enabled.
- If more than one symbol is within the field of view at the same time, symbol data may not be displayed in the order of appearance.
- If **Matchcode Type** is set to **Sequential** or if **Trigger** is set to **Continuous Read 1 Output**, the imager will behave as if **Number of Symbols** were set to **1**, regardless of the user-defined configuration.



## Number of Symbols

**Number of Symbols** is the number of different symbols that can be read in a single read cycle.



## Multisymbol Separator

**Multisymbol Separator** is used to delimit or separate data fields with a user-defined character.

The Multisymbol Separator can be any valid ASCII character, inserted between each symbol read when Number of Symbols is set to any number greater than 1.

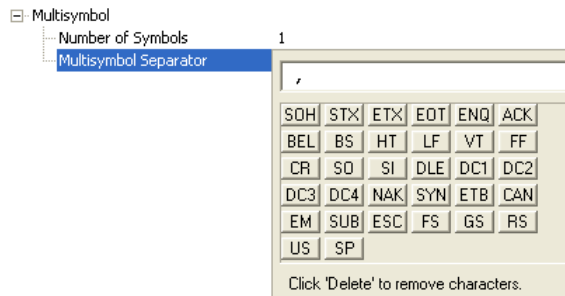

## Trigger

The **Trigger** is the event that initiates a read cycle.

**Note:** When calibrating the imager or testing read rate, the current trigger setting will be disregarded.

Trigger	
Mode	Continuous Read
Trigger Filter Duration	
Leading Edge	313
Trailing Edge	313
External Trigger State	Active Closed

## Trigger Mode

### Continuous Read

**Continuous Read** is useful in testing symbol readability or imager functions. It is not recommended for normal operations.

In Continuous Read, trigger input options are disabled, the imager is always in the read cycle, and it will attempt to decode and transmit data for every symbol. If a single symbol stays within read range for multiple read cycles, its data will be transmitted repeatedly until it leaves the read range.

The imager sends replies to serial commands that require responses when symbol data is transmitted, or read cycle timeout is enabled and a timeout occurs. Depending on the combination of enabled symbologies and the Threshold Mode setting, the imager may take longer than the timeout to process symbol data.

Trigger	
Mode	Continuous Read*
Trigger Filter Duration	
Leading Edge	
Trailing Edge	
External Trigger State	

**Note:** **When to Output** and **No Read** options have no affect on **Continuous Read**.

### **Continuous Read 1 Output**

**Continuous Read 1 Output** can be useful in applications where it is not feasible to use a trigger and all succeeding symbols contain different information. It is also effective in applications where the objects are presented by hand.

In **Continuous Read 1 Output** the imager self-triggers whenever it decodes a new symbol or a timeout occurs.

If **End of Read Cycle Mode** is set to **Timeout** and the symbol doesn't change, the output is repeated at the end of each timeout period. For example, if **Timeout** is set to one second, the imager sends the symbol data immediately and repeats the output at intervals of one second for as long as the symbol remains in the field of view.

If **End of Read Cycle Mode** is set to **New Trigger**, the imager will send the current symbol data immediately, *but only once*. A new symbol appearing in the imager's range will be read and sent immediately, provided it is not identical to the previous symbol.

**Caution:** In automated environments, **Continuous Read 1 Output** is not recommended because there is typically no reliable way to verify that a symbol was missed.

**Note:** If **Trigger Mode** is set to **Continuous Read 1 Output**, the imager will behave as if **Number of Symbols** were set to **1**, regardless of the user-defined configuration.

## External Level

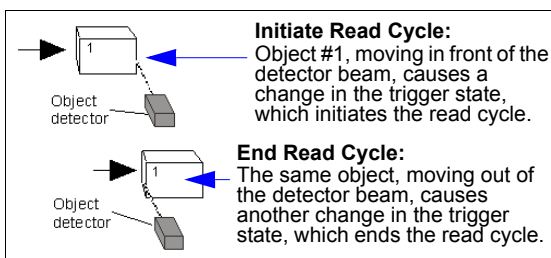

This mode is effective in an application where the speeds of the conveying apparatus are variable and the time the imager spends reading each object is not predictable. It also allows the user to determine if a No Read has occurred.

**External Level** allows the read cycle (active state) to begin when a trigger (change of state) from an external sensing device is received. The read cycle persists until the object moves out of the sensor range and the active trigger state changes again.

**Important:** **Level** and **Edge** apply to the active logic state (**Negative** or **Positive**) that exists while the object is in a read cycle, between the rising edge and the falling edge. *Rising edge* is the trigger signal associated with the appearance of an object. *Falling edge* is the trigger signal associated with the subsequent disappearance of the object. This applies both to **External Level** and **External Edge**.

## External Edge

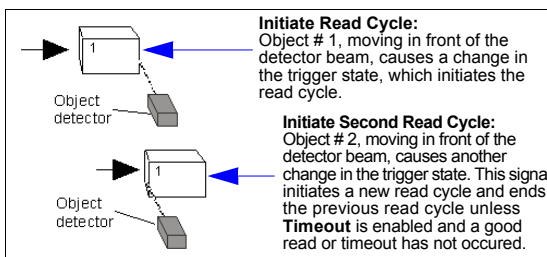

This mode is highly recommended in any application where conveying speed is constant, or if spacing, object size, or read cycle timeouts are consistent.

**External Edge**, as with **Level**, allows the read cycle (active state) to begin when a trigger (change of state) from an external sensing device is received. However, the passing of an object out of sensor range does not end the read cycle. The read cycle ends with a good read output, or, depending on the **End of Read Cycle Mode** setting, a timeout or new trigger occurs.

---

## Read Cycle

### Serial Data

**Serial Data** is effective in a highly controlled environment where the host knows precisely when the object is in the field of view. It is also useful in determining if a No Read has occurred.

In **Serial Data**, the imager accepts an ASCII character from the host or controlling device as a trigger to start a read cycle. A **Serial Data** trigger behaves the same as an **External Edge** trigger.

Serial commands are entered inside angle brackets, as shown here: **<n>**.

**Note:** In **Serial Data**, sending a non-delimited start serial character will start a read cycle; however, a non-delimited stop serial character has no effect.

### Serial Data and Edge

**Serial Data and Edge** is seldom used but can be useful in an application that primarily uses an external sensing device but occasionally needs to be triggered manually.

An auxiliary terminal can be connected to the auxiliary port so the user can send the serial trigger character through the imager to the host.

In this mode the imager accepts either a serial ASCII character or an external trigger pulse to start the read cycle.

**Note:** In **Serial Data**, sending a non-delimited start serial character will start a read cycle; however, a non-delimited stop serial character has no effect.

### Trigger Filter Duration

**Note:** Trigger filter ranges from 32.0  $\mu$ s to 2.10 seconds.

### Leading Edge

Used to ignore accidental triggers when **Trigger Mode** is set to **External Edge** or **External Level**.

To consider a change in state on the trigger input, the level must be stable for the trigger filter duration. In an edge mode, the imager will trigger a read cycle if the active state has been uninterrupted for the entire trigger filter duration. In a level mode, the leading edge is filtered such that on an active edge, the state must be held interrupted for the trigger filter duration before a trigger will occur.

**Note:** 313 = ~10ms.

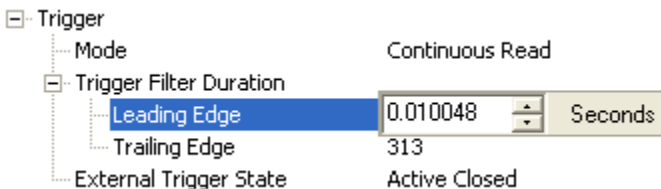

## Trailing Edge

Used to ignore accidental triggers when **Trigger Mode** is set to **External Edge** or **External Level**.

To consider a change in state on the trigger input, the level must be stable for the trigger filter duration. In an edge mode, the imager will trigger a read cycle if the active state has been uninterrupted for the entire trigger filter duration. In a level mode, the trailing edge is filtered such that on the falling edge, the state must be held for the trigger filter duration before the trigger will be deemed inactive.

**Note:** 313 = ~10ms.

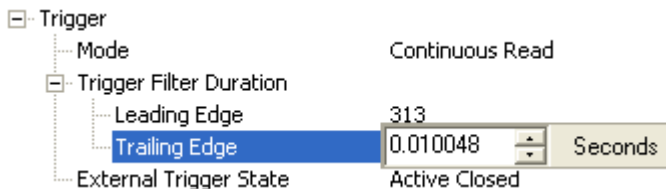

## External Trigger State

Allows users to select the trigger polarity that will be used in their application.

Determines the active state of the trigger signal applied to the cable input of the imager.

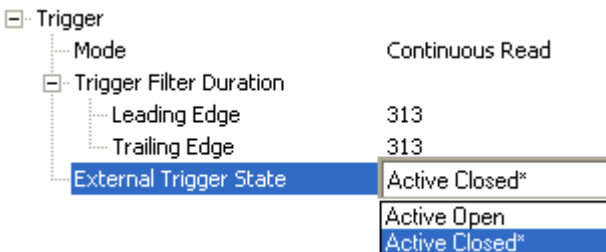

## Serial Trigger

Allows the user to define the trigger character and delimiters that start and stop the read cycle. A serial trigger is considered an online host command and requires the same command format as all host commands. It must be entered within angle bracket delimiters < and > or, in the case of non-delimited triggers, it must define individual start and stop characters.

Serial Trigger	
Character (Delimited)	SP
Start Character (Non-Delimited)	0x00 NUL
Stop Character (Non-Delimited)	0x00 NUL

### Character (Delimited)

Allows the user to define the trigger character that initiates the read cycle. A single ASCII character, including control characters.

**Note:** The following characters cannot be used as serial trigger characters: NUL (0x00), an existing host command character, or an online protocol character.

A delimited trigger character is one that either starts or ends the read cycle and is enclosed by delimiters such as < and >.

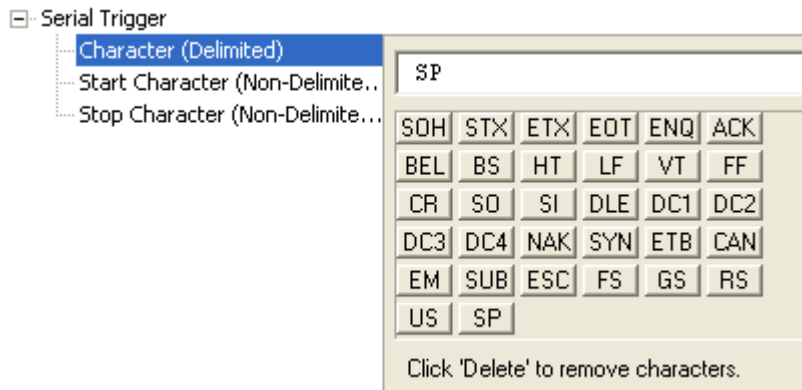

Serial Trigger
Character (Delimited)
Start Character (Non-Delimited)
Stop Character (Non-Delimited)

SP

SOH	STX	ETX	EDT	ENQ	ACK
BEL	BS	HT	LF	VT	FF
CR	SO	SI	DLE	DC1	DC2
DC3	DC4	NAK	SYN	ETB	CAN
EM	SUB	ESC	FS	GS	RS
US	SP				

Click 'Delete' to remove characters.

**Note:** **Serial Data** or **Serial Data and Edge** trigger mode must be enabled for **Serial Trigger Character** to function.



## Start Character (Non-Delimited)

Useful in applications where different characters are required to start a read cycle.

A single ASCII host serial trigger character that starts the read cycle and is not enclosed by delimiters such as < and >.

Non-delimited **Start** characters can be defined and will function according to the trigger event.

When defining **Start** trigger characters, the following rules apply:

- In **External Edge** the imager looks only for the **Start** trigger character and ignores any **Stop** trigger character that may be defined.
- In **External Level** the **Start** trigger character begins the read cycle and the **Stop** trigger character ends it. Note that even after a symbol has been decoded and the symbol data transmitted, the imager remains in **External Level** trigger read cycle until a **Stop** character is received.
- In **Serial Data and Edge** trigger mode, either a **Start** trigger character or a hardware trigger can start an edge trigger read cycle.

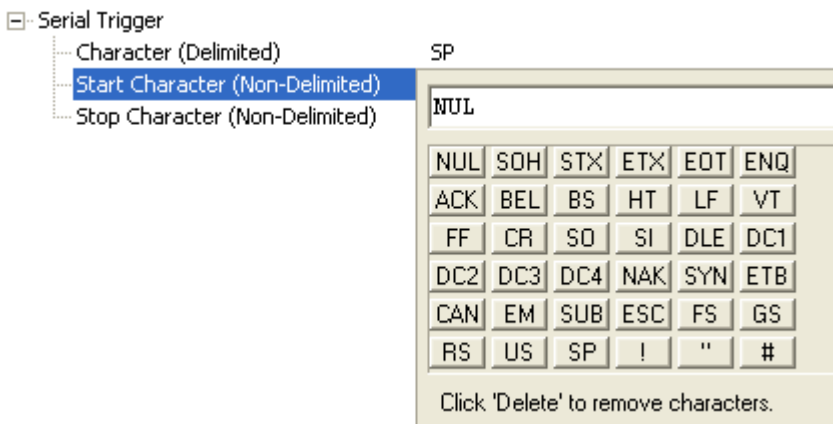

## Stop Character (Non-Delimited)

Useful in applications where different characters are required to end a read cycle.

A single ASCII host serial trigger character that ends the read cycle and is not enclosed by delimiters such as < and >.

Non-delimited **Stop** characters can be defined and will function according to the trigger event.

When defining **Stop** trigger characters, the following rules apply:

- In **External Edge** the imager looks only for the **Start** trigger character and ignores any **Stop** trigger character that may be defined.
- In **External Level** the **Start** trigger character begins the read cycle and the **Stop** trigger character ends it. Note that even after a symbol has been decoded and the symbol data transmitted, the imager remains in **External Level** trigger read cycle until a **Stop** character is received.
- In **Serial Data and Edge** trigger mode, either a **Start** trigger character or a hardware trigger can start an edge trigger read cycle.

Serial Trigger

- Character (Delimited) SP
- Start Character (Non-Delimited) 0x00 NUL
- Stop Character (Non-Delimited)

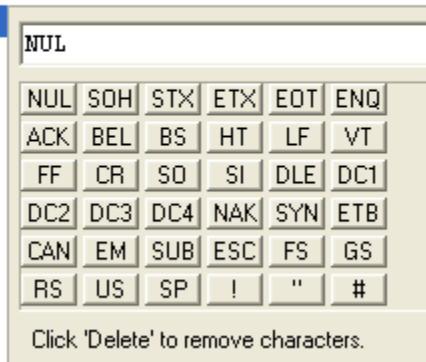

NUL

NUL	SOH	STX	ETX	EOT	ENQ
ACK	BEL	BS	HT	LF	VT
FF	CR	SO	SI	DLE	DC1
DC2	DC3	DC4	NAK	SYN	ETB
CAN	EM	SUB	ESC	FS	GS
RS	US	SP	!	"	#

Click 'Delete' to remove characters.

## ***Decodes Before Output***

**Decodes Before Output** specifies the number of times a symbol needs to be decoded before symbol data is output and a good read is declared.

Decodes Before Output	1	▲▼	(1 - 255)
-----------------------	---	----	-----------

## End of Read Cycle

The read cycle is the time during which the imager will attempt to decode a symbol. A read cycle can be ended by a timeout or a new trigger, or a combination of the two.

[-] End of Read Cycle	
Mode	Timeout
Read Cycle Timeout	200

## End of Read Cycle Mode

**Note:** When operating in **Continuous Read** or **Continuous Read 1 Output**, the imager is always in the read cycle.

[-] End of Read Cycle	
Mode	Timeout*
Read Cycle Timeout	200

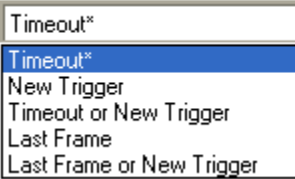

## Timeout

Typically used with **Continuous Read 1 Output** and **Serial Data and Edge**.

It is effective in highly controlled applications when the maximum length of time between objects can be predicted. It assures that a read cycle ends before the next symbol appears, giving the system extra time to decode and transmit the data to the host.

**Timeout** ends the read cycle, causing the imager to stop reading symbols and send the symbol data or No Read message when the time set in **Timeout** elapses (times out), if **When to Output Symbol Data** is set to **End of Read Cycle**.

If in **Continuous Read 1 Output**, a timeout initiates a new read cycle and allows the same symbol to be read again.

With **External Edge**, **Serial Data**, or **Serial Data and Edge** enabled, a timeout ends the read cycle and symbol data or a No Read message is sent to the host.

With **External Level** enabled, the read cycle does not end until the falling edge trigger occurs or a timeout occurs. The next read cycle does not begin until the next rising edge trigger.

## New Trigger

**New Trigger** is an effective way to end a read cycle when objects move past the imager at irregular intervals (not timing-dependent).

**New Trigger** ends the current read cycle and initiates a new one when a new trigger occurs. **New Trigger** refers only to a rising edge trigger.

With **External Edge**, **Serial Data**, or **Serial Data and Edge** enabled, an edge or serial trigger ends a read cycle and initiates the next read cycle.

In the case of **External Level**, a falling edge trigger ends the read cycle but the next read cycle does not begin until the occurrence of the next rising edge trigger.

## Timeout or New Trigger

Useful in applications that require an alternative way to end the read cycle. For example, if an assembly line should stop completely or the intervals between objects are highly irregular.

**Timeout or New Trigger** is identical to **Timeout** except that a timeout or a new trigger (whichever occurs first) ends the read cycle.

## Last Frame

Useful in applications in which the timeout duration varies.

## Last Frame or New Trigger

Useful in applications in which line speeds are irregular and a new object could appear before the last frame in the sequence.

**Last Frame or New Trigger** is identical to **New Trigger** except that a new trigger or last frame (whichever occurs first) ends the read cycle.

## Read Cycle Timeout

**Read Cycle Timeout** determines the duration of the read cycle.

End of Read Cycle

Mode	Timeout
Read Cycle Timeout	2.000 Seconds

## Capture Mode

Capture mode specifies how multiple captures are taken and managed throughout a read cycle.



## Rapid Capture

In a rapid capture mode one or multiple captures can taken at an interval specified by the time delay between captures parameter. In this mode the only limiting time factor is the integration and transfer timing.

## Continuous Capture

In continuous capture mode captures are continually taken throughout the read cycle in a multi-buffered format so that we start processing the first image while we are capturing the second. Continuous capture mode will override the pre-processing field; this improves performance in the multi-buffered format. This mode operation as laser scanners have historically operated, with captures spanning the entire read cycle duration until an exit condition occurs such as qualification or timeout.

## Number of Captures

Specifies the number of captures to process in the rapid capture mode. This parameter is used in conjunction with the time delay between captures parameters to specify the capture sequence of a rapid capture read cycle.

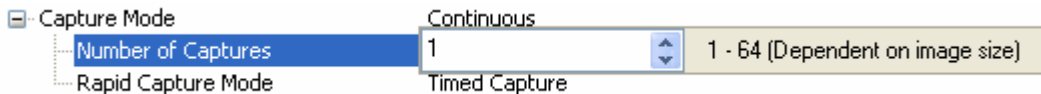

## Rapid Capture Mode



### **Timed Capture**

Capture events are controlled by the timing values entered in the “Capture Time” command.

### **Triggered Capture**

When set to trigger captures mode the imager operates in the following manner:

- The number of captures represents the number of triggers expected from the system per read cycle. The first trigger enters the read cycle.
- Subsequent triggers initiate captures in the read cycle up to the number of captures is met or the end of read cycle condition is met. Any additional triggers between reaching the number of captures and meeting the end of read cycle requirements will be ignored.
- If the read cycle is fully qualified prior to reaching the number of captures and the symbol output is set to ASAP, the symbol data will be output and all post processing (Logic outputs, video, etc.) will finish but the imager will remain in the read cycle. When enough triggers come in to satisfy the number of captures setting or a timeout expires, the imager will exit the read cycle. This operation would be synonymous with level triggered read cycle waiting for the trigger to fall.
- If the end of read cycle is set for new trigger and the read cycle qualifications have not been met, the read cycle will exit upon receiving the first trigger after reaching the number of captures setting. At this time the post processing from the read cycle will complete and a new read cycle will begin.

## Capture Time

This command specifies the frame delays associated with the frames captured in a rapid capture mode of operation.

### Time Before 1st Capture

This value specifies the delay from the trigger to the first capture of any triggered read cycle.

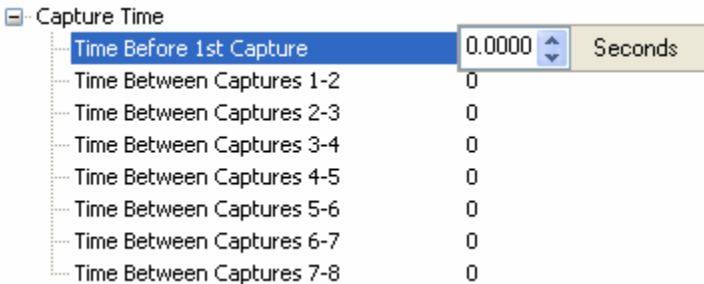

### Time Between Captures 1-2

This value specifies the delay to wait before starting a frame capture for the next capture in the rapid capture sequence.

### Time Between Captures 2-3

This value specifies the delay to wait before starting a frame capture for the next capture in the rapid capture sequence.

### Time Between Captures 3-4

This value specifies the delay to wait before starting a frame capture for the next capture in the rapid capture sequence.

### Time Between Captures 4-5

This value specifies the delay to wait before starting a frame capture for the next capture in the rapid capture sequence.

### Time Between Captures 5-6

This value specifies the delay to wait before starting a frame capture for the next capture in the rapid capture sequence.



### **Time Between Captures 6-7**

This value specifies the delay to wait before starting a frame capture for the next capture in the rapid capture sequence.

### **Time Between Captures 7-8**

This value specifies the delay to wait before starting a frame capture for the next capture in the rapid capture sequence.

### **Notes for Rapid Capture, Timed Capture**

If rapid capture is configured for timed captures this delay is measured from the point at which the previous delay expired. If the delay expires during a previous capture the start of the capture will occur as soon as the previous capture or captures complete. For example, if rapid capture is configured for 8 captures and all delays are configured for zero all 8 captures will occur back to back as fast as the imager is able.

### **Notes for Rapid Capture, Triggered Capture**

If rapid capture is configured for triggered captures mode the delay taken is measured from the point at which the trigger for that capture is received. Also if an incoming trigger occurs before a previous delay has expired, the previous capture is initiated and the delay for the incoming trigger is started.

**Important:** If the unit is triggered to capture more than 8 images the unit will repeat the last delay (8th) for the remaining frames.

## Store No Read Image

Image storage allows the user to store images from separate read cycles and has the ability to retrieve them later. The number of available slots for storage depends on the mode of operation. If functioning in the rapid capture mode the number of images available to store is the maximum **Number of Captures** – the current setting for number of captures. If the user is operating in a continuous capture mode then they can store up to the maximum number of captures – 3.

### Image Storage Type

#### Disabled / Clear

Upon selection, all saved images will be cleared, and the unit will not store images for later retrieving.

#### Store on No Read

The unit will store an image upon exiting the read cycle that retrieved a later time. If multiple captures are present during the duration of a read cycle the image stored will be the last image processed for the read cycle. This image is stored in RAM and can be retrieved as long as power is applied and the unit has not been reset via reset/save sequences. Other commands that can initialize the storage RAM are ones that changed capture modes or put the unit in a test capture mode.



### Image Storage Mode

#### First Image

In this mode the image storage will store images until the available image memory has been filled. At this point the unit will stop saving additional images. In this mode you will always have the first images that were stored.

#### Last Image

In this mode the image storage will continue to store images after the available memory has been filled by purging the oldest image in the storage memory. In this mode you will always have the last images that were stored.



## Image Processing Settings

### Number of Symbols in Field of View

#### Any Number of Symbols

No limit on number of symbols attempted to decode in an image frame.

#### One Symbol

Only one symbol will be decoded in an image frame, and this will be regardless of any qualifying attributes associated with the read cycle.

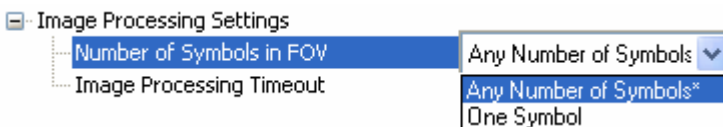

### Image Processing Timeout

Specifies the maximum amount of time allowed for image processing to spend on a captured image. When the time-out expires, the image processing is aborted. This time-out works in both rapid capture and continuous capture modes, as well as with the configuration database.



#### Notes:

The time-out period does not include capture time.

If a time-out occurs the image will be recorded as a No Read. This may cause some confusion because the image may decode fine given enough time.

# Symbologies

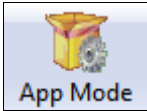

Click the **App Mode** button and then the **Parameters** button to display the tree control tabs.  
Then click the **Symbologies** tab to display the Symbologies tree control.

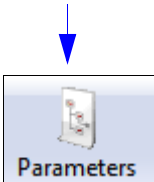

Parameters	ESP Values
[-] Symbologies	
[-] 2D Symbologies	
[-] Data Matrix	
ECC 200 Status	Enabled*
ECC 000 Status	Disabled
ECC 050 Status	Enabled*
ECC 080 Status	Disabled
ECC 100 Status	Disabled
ECC 140 Status	Disabled
ECC 120 Status	Disabled
ECC 130 Status	Disabled
QR Code	Disabled
Micro QR Code	Disabled
Aztec Code	Disabled
[+] 1D Symbologies	
[+] Stacked Symbologies	
[+] Composite	Disabled
Symbology Identifier	Disabled

To open nested options, **single-click** the +.

The \* indicates that the setting is the default.

To change a setting, **double-click** the setting and use the cursor to scroll through the options.

**Note:** Symbologies settings can also be sent to the imager from ESP's Terminal using Microscan's K command format. Refer to the [Gma Vc`c\[ \]Yg](#) section of [Appendix E](#).

## Data Matrix

Data Matrix	
ECC 200 Status	Enabled
ECC 000 Status	Disabled
ECC 050 Status	Disabled
ECC 080 Status	Disabled
ECC 100 Status	Disabled
ECC 140 Status	Disabled
ECC 120 Status	Disabled
ECC 130 Status	Disabled

### ECC 200 Status

#### **Disabled**

The imager will not attempt to decode ECC 200 symbols.

#### **Enabled**

The imager will attempt to decode ECC 200 symbols.

### ECC 000 Status

#### **Disabled**

The imager will not attempt to decode ECC 000 symbols.

#### **Enabled**

The imager will attempt to decode ECC 000 symbols.

### ECC 050 Status

#### **Disabled**

The imager will not attempt to decode ECC 050 symbols.

#### **Enabled**

The imager will attempt to decode ECC 050 symbols.

### ECC 080 Status

#### **Disabled**

The imager will not attempt to decode ECC 080 symbols.

#### **Enabled**

The imager will attempt to decode ECC 080 symbols.

### **ECC 100 Status**

#### ***Disabled***

The imager will not attempt to decode ECC 100 symbols.

#### ***Enabled***

The imager will attempt to decode ECC 100 symbols.

### **ECC 140 Status**

#### ***Disabled***

The imager will not attempt to decode ECC 140 symbols.

#### ***Enabled***

The imager will attempt to decode ECC 140 symbols.

### **ECC 120 Status**

#### ***Disabled***

The imager will not attempt to decode ECC 120 symbols.

#### ***Enabled***

The imager will attempt to decode ECC 120 symbols.

### **ECC 130 Status**

#### ***Disabled***

The imager will not attempt to decode ECC 130 symbols.

#### ***Enabled***

The imager will attempt to decode ECC 130 symbols.

## QR Code



A screenshot of a software interface showing a dropdown menu. The menu is titled "QR Code" and is currently set to "Disabled\*". The dropdown list is open, showing two options: "Disabled\*" (highlighted in blue) and "Enabled".

### Disabled

The imager will not attempt to decode QR Code symbols.

### Enabled

The imager will attempt to decode QR Code symbols.

## Micro QR Code

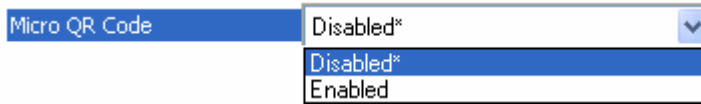

### Disabled

The imager will not attempt to decode Micro QR Code symbols.

### Enabled

The imager will attempt to decode Micro QR Code symbols.



## Code 39

**Code 39** is considered the standard for non-retail 1D symbology.

An alphanumeric symbology with unique start/stop code patterns, composed of 9 black and white elements per character, of which 3 are wide.

<input type="checkbox"/> Code 39	Enabled
<input type="checkbox"/> Check Character Status	Disabled
<input type="checkbox"/> Check Character Output Status	Disabled
<input type="checkbox"/> Large Intercharacter Gap	Disabled
<input type="checkbox"/> Fixed Symbol Length Status	Disabled
<input type="checkbox"/> Fixed Symbol Length	10
<input type="checkbox"/> Full ASCII Set	Disabled

### Check Character Status

Enables or Disables the check character.

Check Character Status	Disabled*
	Disabled*
	Enabled

### Check Character Output Status

**Check Character Output Status**, when added to the symbol, provides additional data security.

When enabled, the check character character is read and compared along with the symbol data. When disabled, symbol data is sent without the check character.

Check Character Output Status	Disabled*
	Disabled*
	Enabled

**Note:** With **Check Character Output Status** enabled and an **External Edge**, **External Level**, or **Serial Data** trigger option enabled, an invalid check character calculation will cause a **No Read Message** to be transmitted at the end of the read cycle.

### Large Intercharacter Gap

**Large Intercharacter Gap** is helpful for reading symbols that are printed out of specification.

When enabled, the imager can read symbols with gaps between symbol characters that exceed three times (3x) the narrow element width.

Large Intercharacter Gap	Disabled*
	Disabled*
	Enabled

**Important:** Do not use **Large Intercharacter Gap** with **Narrow** or **Narrow, Enhanced** Quiet Zone enabled, because a large intercharacter gap (over 3x) could cause a narrow quiet zone (5x) to be interpreted as an intercharacter gap.

### Fixed Symbol Length Status

When enabled, the imager will check the symbol length against the symbol length field. If disabled, any length will be considered valid.

Fixed Symbol Length Status	Disabled*
	Disabled*
	Enabled

### Fixed Symbol Length

**Fixed Symbol Length** helps prevent truncations and increases data integrity by ensuring that only one symbol length will be accepted.

Specifies the exact number of characters that the imager will recognize (this does not include start and stop and check character characters). The imager ignores any symbology that does not match the specified length.

Symbol Length	10	( 1 - 64 )
---------------	----	------------

### Full ASCII Set

Must be enabled when reading characters outside the standard character set (0-9, A-Z, etc.)

The user must know in advance whether or not to use the **Full ASCII Set** option. Since **Full ASCII Set** requires two code words to encode one character, it is less efficient.

Standard Code 39 encodes 43 characters; zero through nine, capital "A" through capital "Z", minus symbol, plus symbol, forward slash, space, decimal point, dollar sign, and percent symbol. When **Full ASCII Set** is enabled, the imager can read the full ASCII character set, from 0 to 255.

Full ASCII Set	Disabled*
	Disabled*
	Enabled

## Code 128

**Code 128** is a smaller symbology useful in applications with limited space and high-security requirements.

A very dense alphanumeric symbology. It encodes all 128 ASCII characters, it is continuous, has variable length, and uses multiple element widths measured edge to edge.

<input type="checkbox"/> Code 128	Disabled
Fixed Symbol Length Status	Disabled
Symbol Length	10
EAN Status	Disabled
Output Format	Standard
Application Record Separator Status	Disabled
Application Record Separator Char	,
Application Record Brackets	Disabled
Application Record Padding	Enabled

### Fixed Symbol Length Status

When enabled, the imager will check the symbol length against the symbol length field. If disabled, any length will be considered a valid symbol.

Fixed Symbol Length Status	Disabled*
	Disabled*
	Enabled

### Symbol Length

**Symbol Length** helps prevent truncations and increases data integrity by ensuring that only one symbol length will be accepted.

This specifies the exact number of characters that the imager will recognize (this does not include start, stop, and check character characters). The imager ignores any symbol not having the specified length.

Symbol Length	10	(1 - 64)
---------------	----	----------

## EAN Status

When this field is disabled, the imager will not check any Code 128 labels for conformance to EAN requirements, or perform any special formatting.

When enabled, the imager can read symbols with or without a function 1 character in the first position. If a symbol has a function 1 character in the first position, it must conform to EAN format. Symbols that conform to EAN format will also be subject to the special output formatting options available in this command.

If EAN status is required, the imager will only decode symbols that have a function 1 character in the first position and that conform to EAN format. All symbols read will be subject to the special output formatting options available in this command.



**Note:** Code 128 status must be enabled for EAN status to be active.

## Output Format

In **Standard**, the imager will not apply special EAN output formatting options.

In **Application**, the imager will apply the special EAN output formatting options to decoded EAN-conforming symbols.



## Application Record Separator Status

When enabled, an EAN separator will be inserted into the output between fields whenever an EAN-conforming symbol is decoded and EAN output formatting applies.

Application Record Separator Status	Disabled*
	Disabled*
	Enabled

## Application Record Separator Character

This is an ASCII character that serves as an EAN separator in formatted EAN output.

Application Record Separator Character	<input type="text" value="."/>																																				
	<table border="1"> <tr> <td>NUL</td><td>SOH</td><td>STX</td><td>ETX</td><td>EOT</td><td>ENQ</td> </tr> <tr> <td>ACK</td><td>BEL</td><td>BS</td><td>HT</td><td>LF</td><td>VT</td> </tr> <tr> <td>FF</td><td>CR</td><td>SO</td><td>SI</td><td>DLE</td><td>DC1</td> </tr> <tr> <td>DC2</td><td>DC3</td><td>DC4</td><td>NAK</td><td>SYN</td><td>ETB</td> </tr> <tr> <td>CAN</td><td>EM</td><td>SUB</td><td>ESC</td><td>FS</td><td>GS</td> </tr> <tr> <td>RS</td><td>US</td><td>SP</td><td></td><td></td><td></td> </tr> </table>	NUL	SOH	STX	ETX	EOT	ENQ	ACK	BEL	BS	HT	LF	VT	FF	CR	SO	SI	DLE	DC1	DC2	DC3	DC4	NAK	SYN	ETB	CAN	EM	SUB	ESC	FS	GS	RS	US	SP			
NUL	SOH	STX	ETX	EOT	ENQ																																
ACK	BEL	BS	HT	LF	VT																																
FF	CR	SO	SI	DLE	DC1																																
DC2	DC3	DC4	NAK	SYN	ETB																																
CAN	EM	SUB	ESC	FS	GS																																
RS	US	SP																																			
	Click 'Delete' to remove characters.																																				

## Application Record Brackets

If an EAN-conforming symbol is decoded and EAN formatting applies, this feature places bracket characters around the application identifiers in the formatted output.

Application Record Brackets	Disabled*
	Disabled*
	Enabled

## Application Record Padding

This feature causes the imager to pad variable-length application fields with leading zeroes. This is not done for the last field of a symbol.

Application Record Padding	Disabled
	Disabled
	Enabled*

## BC412

BC412	Disabled
Check Character Output Status	Disabled
Fixed Symbol Length Status	Disabled
Fixed Symbol Length	10

### Check Character Output Status

#### Disabled

The imager will strip the verified check digit from the symbol data.

#### Enabled

The imager will format the verified check digit as part of the symbol data.

BC412	Disabled
Check Character Output Status	Disabled*
Fixed Symbol Length Status	Disabled*
Fixed Symbol Length	Enabled

### Fixed Symbol Length Status

#### Disabled

The imager will accept any length BC412 symbol as valid.

#### Enabled

The imager will reject any BC412 symbol that does not match the fixed code length value for BC412.

BC412	Disabled
Check Character Output Status	Disabled
Fixed Symbol Length Status	Disabled*
Fixed Symbol Length	Disabled*

### Fixed Symbol Length

The code length used to validate BC-412 symbols if the fixed code length status is set to enabled.

BC412	Disabled
Check Character Output Status	Disabled
Fixed Symbol Length Status	Disabled
Fixed Symbol Length	10 (1 - 64)

## Interleaved 2 of 5

**Interleaved 2 of 5** has been popular because it is the most dense symbology for printing numeric characters less than 10 characters in length; however, Microscan does not recommend this symbology for any new applications because of inherent problems such as symbol truncation.

A dense, continuous, self-checking, numeric symbology. Characters are paired together so that each character has five elements, two wide and three narrow, representing numbers 0 through 9, with the bars representing the first character and the interleaved spaces representing the second character. (A check character is highly recommended).

<input type="checkbox"/> Interleaved 2 of 5	Disabled
Check Character Status	Disabled
Check Character Output Status	Disabled
Symbol Length 1	10
Symbol Length 2	6
Guard Bar	Disabled
Range Mode Status	Disabled

### Check Character Status

This option is not typically used, but it can be enabled for additional security in applications where the host requires redundant check character verification.

An error correcting routine in which the check character character is added.

Check Character Status	Disabled*
	Disabled*
	Enabled

### Check Character Output Status

When enabled, a check character character is sent along with the symbol data for added data security.

Check Character Output Status	Disabled*
	Disabled*
	Enabled

## Symbol Length 1

Useful in applications where Interleaved 2 of 5 symbols of a specific length are required. The **Symbol Length 1** field is one of two fields against which the decoded symbol is compared before accepting it as valid or rejecting it.

**Important:** If **Range Mode Status** is set to **Disabled**, the length of the symbol must match either **Symbol Length 1** or **Symbol Length 2** to be considered a valid symbol.

If **Range Mode Status** is set to Enabled, **Symbol Length 1** and **Symbol Length 2** form a range into which the length of the symbol must fall to be considered valid.

A screenshot of a control element for 'Symbol Length 1'. It consists of a blue rectangular label on the left containing the text 'Symbol Length 1'. To the right of the label is a white input field containing the number '10'. Further right is a small blue square with white up and down arrows. To the right of the arrows is a grey rectangular box containing the text '(0 - 64)'.

## Symbol Length 2

Useful in applications where Interleaved 2 of 5 symbols of a specific length are required. The **Symbol Length 2** field is one of two fields against which the decoded symbol is compared before accepting it as valid or rejecting it.

**Important:** If **Range Mode Status** is set to **Disabled**, the length of the symbol must match either **Symbol Length 2** or **Symbol Length 1** to be considered a valid symbol.

If **Range Mode Status** is set to Enabled, **Symbol Length 2** and **Symbol Length 1** form a range into which the length of the symbol must fall to be considered valid.

A screenshot of a control element for 'Symbol Length 2'. It consists of a blue rectangular label on the left containing the text 'Symbol Length 2'. To the right of the label is a white input field containing the number '6'. Further right is a small blue square with white up and down arrows. To the right of the arrows is a grey rectangular box containing the text '(0 - 64)'.

## Guard Bar

**Note:** Whenever **Guard Bar** is enabled, the presence of guard bars is required for decoding to take place.

Useful when Interleaved 2 of 5 multisymbols are enabled to prevent false data output. This typically occurs with highly tilted or skewed symbols.

A guard bar is a heavy bar, at least twice the width of the wide bar, surrounding the printed Interleaved 2 of 5 symbol and helping to prevent false reads.

A screenshot of a dropdown menu for 'Guard Bar'. On the left is a blue rectangular label containing the text 'Guard Bar'. To the right is a white rectangular box containing a dropdown menu. The menu is currently open, showing three options: 'Disabled\*' (top), 'Disabled\*' (middle, highlighted with a blue background), and 'Enabled' (bottom).



## Range Mode Status

**Important:** Unless **Range Mode** is enabled, **Symbol Length** must be set to decode Interleaved 2 of 5 symbols.

Useful in applications where Interleaved 2 of 5 symbols of a specific length are required.

When **Range Mode** is disabled, the imager checks the value of the symbol length against the values set in **Symbol Length 1** and **Symbol Length 2**. If the symbol length does not match either of the preset values, then it is rejected as invalid.

When **Range Mode** is enabled, **Symbol Length 1** and **Symbol Length 2** are combined to form a range of valid symbol lengths. Any symbol length that does not fall into this range is rejected as an invalid symbol. Either of the preset symbol length values in the **Symbol Length 1** and **Symbol Length 2** fields can form the start or end of the range.



## Codabar

Used in photo-finishing and library applications. Previously used in medical applications, but not typically used in newer medical applications.

Codabar is a 16-bit character set (0 through 9, and the characters \$, :, /, ., +, and -) with start/stop codes and at least two distinctly different bar widths.

<input type="checkbox"/> Codabar	Disabled
Start and Stop Match Status	Enabled
Start and Stop Output Status	Enabled
Large Intercharacter Gap	Disabled
Fixed Symbol Length Status	Disabled
Symbol Length	10
Check Character Type	Disabled
Check Character Output Status	Disabled

### Start and Stop Match Status

When disabled, the imager will decode Codabar symbols whether or not the start and stop characters are the same.

When enabled, the imager will not decode Codabar symbols unless the start and stop characters are the same.

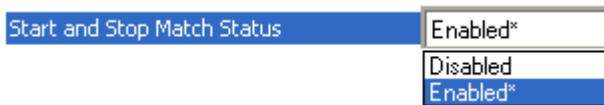

### Start and Stop Output Status

When disabled, the start and stop characters will *not* be present in the data output of the decoded symbol.

When enabled, the start and stop characters *will* be present in the data output of the decoded symbol.

**Note:** Because the start and stop characters are included as part of the data, the characters must be included as part of the length in a fixed length mode of operation.

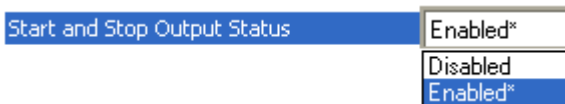

## Large Intercharacter Gap

When disabled, the spaces between characters, or the “intercharacter gap”, are ignored during the decode process.

**Note:** If the intercharacter space is large enough to be considered a margin, the symbol will not decode, regardless of this parameter’s setting.

Large Intercharacter Gap	Disabled*
	Disabled*
	Enabled

## Fixed Symbol Length Status

When disabled, the imager will accept any Codabar symbol provided it doesn’t exceed the system’s maximum capabilities.

When enabled, the imager will reject any Codabar symbol that doesn’t match the fixed length.

Fixed Symbol Length Status	Disabled*
	Disabled*
	Enabled

## Symbol Length

This is the value against which all Codabar symbol lengths will be compared.

Symbol Length	10	(1 - 64)
---------------	----	----------

## Check Character Type

When disabled, the imager will not perform any character checking calculations on decoded Codabar symbols.

When set to **Mod 16**, the imager will perform a modulus 16 check character calculation on the symbol. If the symbol does not pass this calculation, it will not be decoded.

When set to **NW 7**, the imager will perform an NW7 modulus 11 check character calculation on the symbol. If the symbol does not pass this calculation, it will not be decoded.

When set to **Both**, the imager will perform both the Mod 16 and NW7 modulus 11 check character calculations on the symbol. If the symbol does not pass either calculation, it will not be decoded.

Check Character Type	Disabled*
	Disabled*
	Mod 16
	NW 7
	Both

## Check Character Output Status

When this field is disabled and a check character calculation is enabled, the imager will strip the verified check character from the symbol data output. This condition must be accounted for if a fixed length is also being used.

When enabled, the imager will output the check character as part of the symbol data. This condition must be accounted for if a fixed length is also being used.

Check Character Output Status	Disabled*
	Disabled*
	Enabled

## UPC/EAN

Used primarily in point-of-sale applications in the retail industry. It is commonly used with Microscan imagers in applications in combination with **Matchcode** when there is a need to verify that the right product is being placed in the right packaging.

**UPC** (Universal Product Code) is a fixed length, numeric, continuous symbology. UPC can have two- or five-digit supplemental data following the normal symbol. The UPC Version A (UPC, A) symbol is used to encode a 12 digit number. The first digit is the number system character, the next five are the manufacturer number, the next five are the product number, and the last digit is the checksum character.

When enabled, the imager will read UPC Version A and UPC Version E only.

UPC/EAN	Disabled
EAN Status	Disabled
Supplementals Status	Disabled
Separator Status	Disabled
Separator Character	,
Supplementals Type	Both
UPC-E as UPC-A	Disabled

## EAN Status

**EAN** is the European version of the UPC symbology and is used in European retail applications.

**Note:** **UPC** must be enabled for **EAN** to take effect.

EAN is a subset of UPC. When enabled, the imager will read UPC Version A, UPC Version E, EAN 13, and EAN 8. It also appends a leading zero to UPC Version A symbol information and transmits 13 digits. If transmitting 13 digits when reading UPC Version A symbols is not desired, disable EAN.

EAN Status	Enabled
	Disabled*
	Enabled

**Note:** The extra character identifies the country of origin.

## Supplementals Status

Reads **Supplementals** typically used in publications and documentation.

A supplemental is a 2 to 5 digit symbol appended to the main symbol. When set to **Enabled** or **Required**, the imager reads supplemental code data that has been appended to the standard UPC or EAN codes.



### **Disabled**

UPC **Supplementals** will not be decoded.

### **Enabled**

When enabled, the imager will try to decode a main and a supplemental. However, if a supplemental is not decoded, the main will be sent by itself at the end of the read cycle.

### **Required**

When set to **Required**, both the main and the supplemental symbols must be read or a single No Read condition results.

For example, if **Supplementals** is set to **Required**, **Separator** is enabled, and an asterisk is defined as the UPC separator character. Then the data is displayed as:

MAIN \* SUPPLEMENTAL.

**Note:** Under no circumstances will the supplemental symbol data be sent without a main symbol.

**Note:** If additional symbols—other than the main or supplemental—will be read in the same read cycle, **Number of Symbols** should be set accordingly.

## Separator Status

Allows users to distinguish between the main and **Supplemental** symbols.

A character can be inserted between the standard UPC or EAN symbology and the supplemental symbology when **Supplementals** is set to **Enabled** or **Required**.



## Separator Character

As required by the application.

Allows the user to change the separator character from a comma to a new character.

**Note:** Whenever **Separator Character** is defined as a comma ( , ) sending a **<K473,s?>** command from ESP's Terminal will return the current settings, including the separator character comma which appears after the separator status comma.

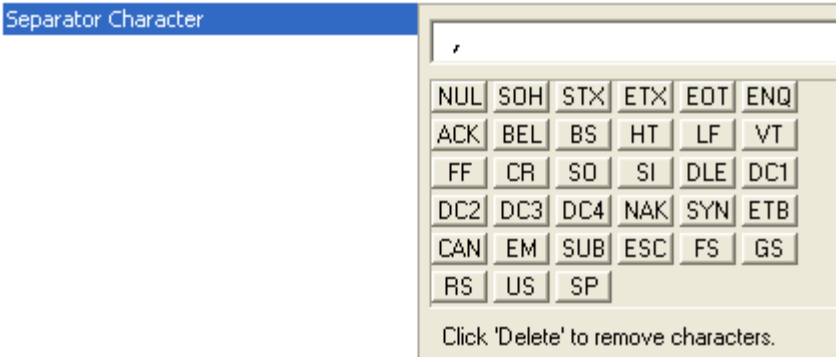

## Supplementals Type

As required by symbology used in application.

Allows the user to select 2 character or 5 character supplements, or both.



### **Both**

Either 2 character or 5 character supplements will be considered valid.

### **Two Digits**

Only two character supplements will be considered valid.

### **Five Digits**

Only five character supplements will be considered valid.

## UPC-E as UPC-A

When disabled, the imager will output the version E symbols in their encoded 6-character format.

When enabled, the imager will format the symbol as either a 12-character UPC-A symbol or an EAN-13 symbol, depending on the state of the EAN status parameter. This formatting reverses the zero suppression that is used to generate the symbol in the UPC specification.





## Code 93

Used in some clinical applications.

Code 93 is a variable-length, continuous symbology employing four element widths. Each Code 93 character has nine modules that may be either black or white. Each character contains three bars and three spaces.

<input type="checkbox"/> Code 93	Disabled
Fixed Symbol Length Status	Disabled
Symbol Length	10

### Fixed Symbol Length Status

When disabled, the imager will accept any Code 93 symbol provided is doesn't exceed the system's maximum capabilities.

When enabled, the imager will reject any Code 93 symbol that doesn't match the fixed symbol length.

Fixed Symbol Length Status	Disabled*
	Disabled*
	Enabled

### Fixed Symbol Length

This is the symbol length value against which all Code 93 symbols will be compared.

Symbol Length	10	(1 - 64)
---------------	----	----------

## Pharmacode

Used mostly in pharmaceutical packaging.

Encodes up to five different numbers, each with its own color, which may be entered in decimal or “binary” format with a **1** represented by a thick bar and a **0** represented by a thin bar. Bar width is independent of height.

In decimal format, each part can be up to 999,999.

In binary format, each input can have up to 19 ones and zeros.

<input type="checkbox"/> Pharmacode	Disabled
Fixed Symbol Length Status	Disabled
Symbol Length	5
Minimum Bars	2
Bar Width Status	Mixed
Direction	Forward
Fixed Threshold Value	10
Background Color	White

**Important:** When Pharmacode is enabled, other linear symbologies will not decode properly. Disable Pharmacode before reading other linear symbologies.

### Fixed Symbol Length Status

When enabled, the imager will check the symbol length against the symbol length field. If disabled, any length will be considered valid.

Fixed Symbol Length Status	Disabled*
	Disabled*
	Enabled

### Symbol Length

Specifies the exact number of bars that must be present for the imager to recognize and decode the Pharmacode symbol.

Symbol Length	10	▲ ▼	(1 - 16)
---------------	----	-----	----------

### Minimum Bars

Sets the minimum number of bars that a Pharmacode symbol must have to be considered valid.

Minimum Bars	5	▲ ▼	(1 - 16)
--------------	---	-----	----------

## Bar Width Status

If set to **Mixed**, the imager will autodiscriminate between narrow bars and wide bars. If set to **All Narrow**, all bars will be considered as narrow bars. If set to **All Wide**, all bars will be considered as wide bars. If set to **Fixed Threshold**, it will use the fixed threshold value to determine whether the bars are narrow or wide. The **Bar Width Status** setting will be ignored when the imager is able to tell the difference between the narrow and the wide bars.



## Direction

Specifies the direction in which a symbol can be read.



## Fixed Threshold Value

Used when **Bar Width Status** is set to **Fixed Threshold**. Defines the minimum difference in pixels that will distinguish a narrow bar from a wide bar.



## Background Color

Specifies whether the symbol will be presented on a black background or a white background.

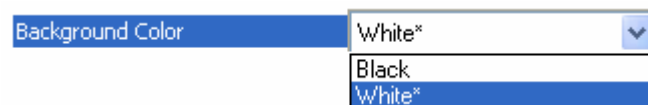

## Postal Symbologies

**Important: Postal Symbologies** must have a pixels-per-element value of no more than 7 to be decoded reliably by the QX Hawk.

The imager must be configured to specific read range, field of view, and camera parameters before decoding Postal Symbologies.

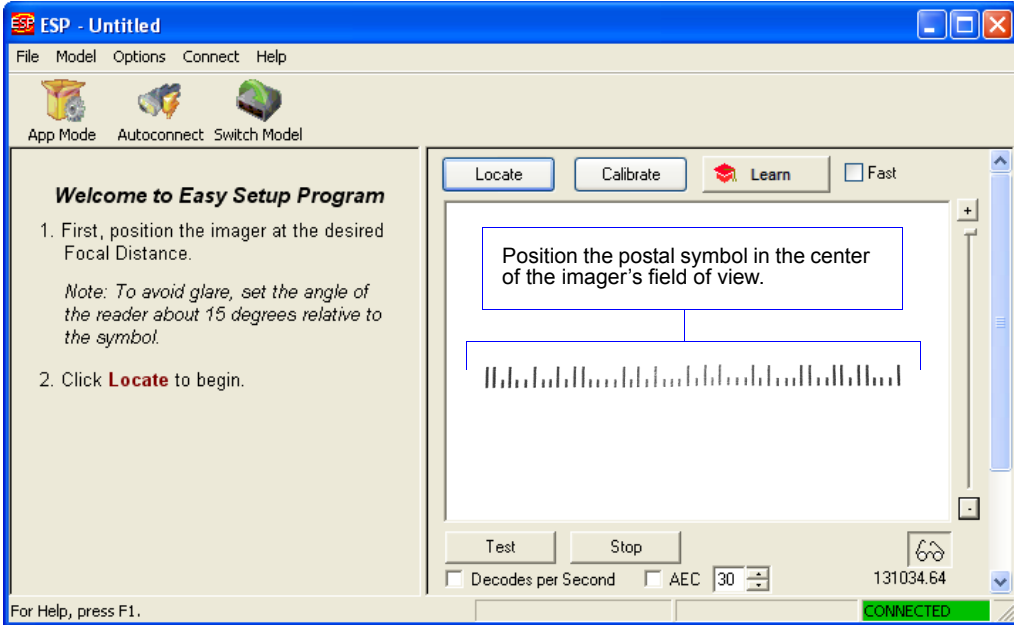

## Postal Symbology Type

1D **Postal Symbologies** are used in mail sortation, auditing, certified mail, registered mail, metered mail, and point-of-sale (POS) applications.

This command determines the postal symbology that will be decoded by the imager.

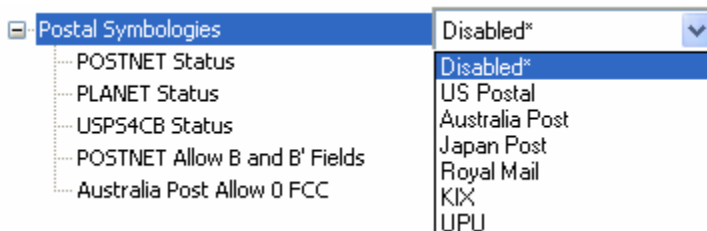

### ***U.S. Postal (POSTNET, PLANET, USPS4CB)***

When **U.S. Postal** is enabled, the imager will only decode **POSTNET**, **PLANET**, and **USPS4CB** symbols.

**Important:** **POSTNET Status**, **PLANET Status**, and **USPS4CB Status** are enabled by default. However, if any of the three U.S. Postal symbologies is set to **disabled** individually, symbols of that type will not be decoded by the imager even when U.S. Postal is enabled.

For example, if **U.S. Postal** is enabled but **POSTNET Status** is disabled, **POSTNET** symbols will not be decoded by the imager.

See [POSTNET Status](#), [PLANET Status](#) and [USPS4CB Status](#) for more detail about U.S. Postal symbologies.

### ***Australia Post***

When **Australia Post** is enabled, the imager will only decode Australia Post symbols.

### ***Japan Post***

When **Japan Post** is enabled, the imager will only decode Japan Post symbols.

### ***Royal Mail***

When **Royal Mail** is enabled, the imager will only decode Royal Mail symbols.

### ***KIX***

When **KIX** is enabled, the imager will only decode KIX symbols.

### ***UPU***

When **UPU** is enabled, the imager will decode UPU symbols *and* any **U.S. Postal** symbologies that might be enabled.

For example, if **Postal Symbology Type** is set to **UPU** and **POSTNET Status** is enabled and, the imager will attempt to decode both UPU and POSTNET symbols.

## POSTNET Status

**POSTNET** is used by the United States Postal Service to direct mail. The ZIP Code or ZIP+4 Code is encoded in the symbol. Data is encoded in half-height and full-height bars, making POSTNET a “2-state” symbology. The delivery point (usually the last two digits of the address or post office box number) is also typically encoded in POSTNET symbols. If **U.S. Postal** and **POSTNET Status** are both enabled, the imager will decode POSTNET symbols.

POSTNET Status	Enabled*
	Disabled
	Enabled*

## PLANET Status

**PLANET (Postal Alphanumeric Encoding Technique)** is a symbology used by the United States Postal Service to track and identify items during delivery. Each PLANET symbol is either 12 or 14 digits long, and encodes data in half-height and full-height bars, making PLANET a “2-state” symbology. The symbol always starts and ends with a full-height bar, or “guard rail”, and each individual digit is represented by a set of five bars in which two of the bars are always short.

If **U.S. Postal** and **PLANET Status** are both enabled, the imager will decode PLANET symbols.

PLANET Status	Enabled*
	Disabled
	Enabled*

## USPS4CB Status

**USPS4CB**, also called **Intelligent Mail**, is used by the United States Postal Service to sort and track individual items as well as flats of mail. USPS4CB combines the capabilities of POSTNET and PLANET, and can encode 31 digits (65 bars). USPS4CB symbols are slightly longer than POSTNET symbols, and offer additional flexibility in choosing symbol height and width.

Data is encoded in four types of bars (“states”), each of which is identified by a name and a value. This type of postal symbol is known as “4-state”. Each bar has a “tracker”, or middle section, to which an “ascender” (top section) or “descender” (bottom section) may be added. The 4-state format allows the symbol to contain more information, and makes it easier to decode. 4-state symbols can also be printed easily in a variety of media, including dot matrix, inkjet, and laser.

If **U.S. Postal** and **USPS4CB Status** are both enabled, the imager will decode USPS4CB symbols.

USPS4CB Status	Enabled*
	Disabled
	Enabled*

## POSTNET Allow B and B' Fields

If **U.S. Postal** and **POSTNET** are enabled, and **POSTNET Allow B and B' Fields** is enabled, the imager will allow B and B' fields in POSTNET symbols.

POSTNET Allow B and B' Fields	Disabled*
	Disabled*
	Enabled

## Australia Post Allow 0 FCC

If **Australia Post** is enabled, and **Australia Post Allow 0 FCC** is enabled, the imager will allow 0 FCC in Australia Post symbols.

Australia Post Allow 0 FCC	Disabled*
	Disabled*
	Enabled

## GS1 DataBar

**Note:** GS1 DataBar symbologies were previously known as “Reduced Space Symbology” or “RSS”.

<input type="checkbox"/> DataBar Expanded	Disabled
<input type="checkbox"/> Fixed Symbol Length Status	Disabled
<input type="checkbox"/> Fixed Symbol Length	14
<input type="checkbox"/> DataBar Limited	Disabled
<input type="checkbox"/> DataBar Omnidirectional	Disabled

### DataBar Expanded

**Note:** DataBar Expanded was previously known as “RSS Expanded”.

Used to encode primary and supplementary data in retail point-of-sale and other applications.

DataBar Expanded is a variable length symbology that can encode supplementary information in addition to the 14-digit EAN item identification number and is capable of encoding up to 74 numeric or 41 alphabetic characters.

Where appropriate, use 1 (non-stacked) for better performance over 2 (stacked and non-stacked).

<input type="checkbox"/> DataBar Expanded	Disabled
<input type="checkbox"/> Fixed Symbol Length Status	Disabled
<input type="checkbox"/> Fixed Symbol Length	14

### Fixed Symbol Length Status

When enabled, the imager will check the symbol length against the symbol length field, minus the embedded check character. If disabled, any length would be considered valid.

Fixed Symbol Length Status	Disabled*
	Disabled*
	Enabled

### Fixed Symbol Length

**Fixed Symbol Length** helps prevent truncations and increases data integrity by ensuring that only one symbol length will be accepted.

Specifies the exact number of characters that the imager will recognize (this does not include start, stop, and check character characters). The imager ignores any symbol not having the specified length.

Fixed Symbol Length	14	[ 1 - 74 ]
---------------------	----	------------



## DataBar Limited

**Note:** **DataBar Limited** was previously known as “RSS Limited”.

DataBar Limited is designed to be read by laser scanners and CCD imagers. It is not recommended for omnidirectional slot imagers.

Encodes a smaller 14-digit symbol (74 modules wide) that is not omnidirectional.

DataBar Limited	Disabled*
	Disabled*
	Enabled

## DataBar Omnidirectional

**Note:** **DataBar Omnidirectional** was previously known as “RSS-14”.

Used in the grocery, retail, and prescription drug industries where 14-digit EAN item identification may be needed.

DataBar-14 is a fixed symbol length symbology that encodes 14 digits, including a 1-digit indicator. DataBar-14 is 96 modules wide. It can be stacked in two rows, it can read omnidirectionally if printed in full height, or horizontally if height-truncated for small marking.

**Note:** Where appropriate, use **1** (non-stacked) for better performance instead of **2** (stacked; decode both stacked and non-stacked).

DataBar Omnidirectional	Disabled*
	Disabled*
	Enabled

## PDF417

Used in applications where a large amount of information (over 32 characters) needs to be encoded within a symbol, typically where the symbol is transported from one facility to another. For example, an automobile assembly line might use a single symbol with multiple fields of information that will be read at several stations along the way, without reference to a database.

A two-dimensional, multi-row (3 to 90), continuous, variable-length symbology that has high data capacity (up to 2,700 numeric characters, 1,800 printable ASCII characters, or 1,100 binary characters per symbol). Each symbol character consists of 4 bars and 4 spaces in a 17-module structure.

PDF417	Disabled
Fixed Symbol Length Status	Disabled
Fixed Symbol Length	10
Codeword Collection	Single Image

**Note:** Sending **<a1>** from ESP's Terminal will cause PDF417 data to be prefaced with information consisting of error correction level (ECC Level **n**), number of rows (**n** Rows), number of columns (**n** Columns), number of informative code words (**n** Info Code Words) and the number of data characters (**n** Data Characters). This feature can be disabled by re-sending **<a1>**.

### Fixed Symbol Length Status

When Enabled, the imager will reject any PDF417 symbol that does not match the **Fixed Symbol Length**.

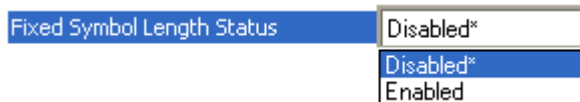

### Fixed Symbol Length

Used to increase data integrity by ensuring that only one symbol length will be accepted. When enabled, the PDF symbol must contain the same number of characters as the symbol length setting before it can be considered a good read. The imager will ignore any symbol not having the specified length.



**Note:** **Fixed Symbol Length Status** must be enabled for **Fixed Symbol Length** to take effect.

## Codeword Collection



### ***Single Image***

The imager will attempt to decode the PDF417 symbol only from the information provided in a single image.

### ***Multiple Image***

The imager will process codewords from multiple images within the same read cycle and combine them to decode a single PDF417 symbol.

## MicroPDF417

Used for labelling small items that need large data capacity.

A variant of PDF417, a very efficient and compact stacked symbology that can encode up to 250 alphanumeric characters or 366 numeric characters per symbol.

<input type="checkbox"/> Micro PDF417	Disabled
Fixed Symbol Length Status	Disabled
Fixed Symbol Length	10

### Fixed Symbol Length Status

When Enabled, the imager will reject any MicroPDF417 symbol that does not match the **Fixed Symbol Length**.

Fixed Symbol Length Status	Disabled*
	Disabled*
	Enabled

### Fixed Symbol Length

Used to increase data integrity by ensuring that only one symbol length will be accepted.

When enabled, the MicroPDF417 symbol must contain the same number of characters as the symbol length setting before it can be considered a good read. The imager will ignore any symbol not having the specified length.

Fixed Symbol Length	10	÷	(1 - 366)
---------------------	----	---	-----------

**Note:** **Fixed Symbol Length Status** must be enabled for **Fixed Symbol Length** to take effect.

## Aztec Code

Used in document imaging, railway ticket validation, and some postal applications.

A 2D matrix symbology built on a square grid with a square “bull’s-eye” pattern at the center. **Aztec Code** can encode up to 3,832 numeric or 3,067 alphabetical characters, or 1,914 bytes of data.

The level of Reed-Solomon error correction used with Aztec Code is configurable, from 5% to 95% of the total data region. The recommended error correction level is 23% of symbol capacity plus codewords.



### Disabled

The imager will not attempt to decode Aztec symbols.

### Enabled

The imager will attempt to decode Aztec symbols.

## Composite

When set to **Enabled** or **Required**, will decode the 2D composite component of a linear symbol. The linear symbol can be DataBar-14, DataBar Expanded, DataBar Limited, EAN-128, UPC-A, EAN-13, EAN-8, and UPC-E.

Composite	Disabled
Separator Status	Disabled
Separator	,

### Enabled

If **Composite** is set to **Enabled**, the imager will decode both the 2D composite and linear components. However, if the 2D composite component is not decoded, the linear data will be sent by itself at the end of the read cycle.

### Required

If set to **Required**, the imager must decode both components, or a No Read will occur.

## Separator Status

Allows the user to distinguish between the main and **Supplemental** symbols.

Separates the linear and the composite component.



## Separator

The Separator Character will be the same as the character defined in the **Multisymbol Separator** field.

As required by the application.

Allows the user to change the separator character from a comma to a new character.

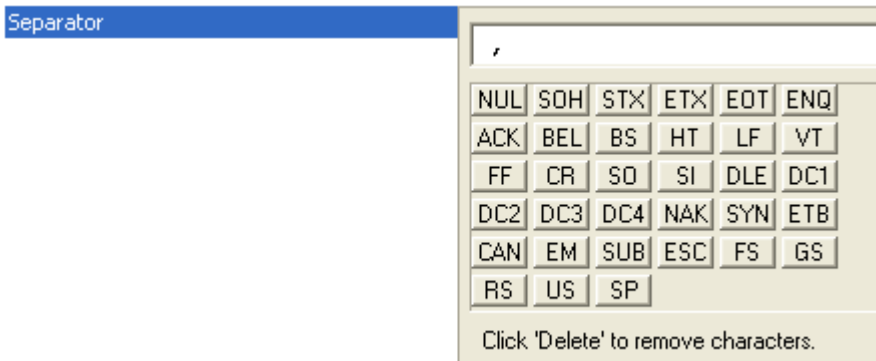

## Symbology Identifier

**Symbology Identifier** is a standard prefix set of characters that identifies the symbol type. When enabled, the imager analyzes and identifies the symbology and adds a three-character identifying prefix to the data:

- ] (closed bracket character) indicating the presence of a symbology identifier.
- **A, C, E, F, G, I, L, e, or Q**
- (A = Code 39; C = Code 128; E = UPC/EAN; F = Codabar; G = Code 93; I = Interleaved 2 of 5; L = PDF417 and MicroPDF417; e = GS1 DataBar (RSS); Q = Pharmacode)
- Modifier

*Example:* ]**C** indicates a Code 128 symbol.



### Disabled

When set to **Disabled**, symbol data output does not contain Symbology Identifier information.

### Enabled

When set to **Enabled**, symbol data output contains a Symbology Identifier sequence.

## Explanation of Modifiers for Code 39, Codabar, and Interleaved 2 of 5

- For Code 39, Codabar, and Interleaved 2 of 5, the modifier indicates **Check Character** and **Check Character Output** status.
- For Code 39 only, Full ASCII must be enabled to see modifiers **4, 5, and 7**.

<i>Modifier</i>	<i>Check Character</i>	<i>Check Character Output</i>	<i>Full ASCII Conversion (Code 39 Only)</i>
<b>0</b>	Disabled	N/A	No
<b>1</b>	Enabled	Enabled	No
<b>3</b>	Enabled	Disabled	No
<b>4</b>	Disabled	N/A	Yes
<b>5</b>	Enabled	Enabled	Yes
<b>7</b>	Enabled	Disabled	Yes

*Example:* ]**A5** indicates a **Code 39** symbol with **Check Character** and **Check Character Output** enabled and Full ASCII conversion performed.

## Explanation of Modifiers for Other Symbologies

- For Code 128, a **1** indicates EAN 128; otherwise the modifier is **0**.
- For all other symbologies, the modifier is **0**.

# I/O Parameters

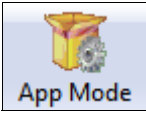

Click the **App Mode** button and then the **Parameters** button to display the tree control tabs.  
Then click the **I/O** tab to display the I/O Parameters tree control.

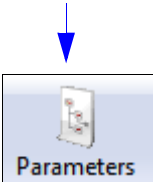

Parameters	ESP Values
<input type="checkbox"/> I/O Parameters	
<input type="checkbox"/> Symbol Data Output	Good Read
<input type="checkbox"/> No Read Message	Enabled
<input type="checkbox"/> Read Duration Output	Disabled
<input type="checkbox"/> Output Object Info	Disabled
<input type="checkbox"/> Output Indicators	
<input type="checkbox"/> Serial Verification	
<input type="checkbox"/> EZ Trax Output	Disabled
<input type="checkbox"/> EZ Button	Enabled
<input type="checkbox"/> Status Indicators	PHY Activity
<input type="checkbox"/> Calibration Options	
<input type="checkbox"/> Database Identifier Output	Disabled
<input type="checkbox"/> Input 1	Disabled*
<input type="checkbox"/> Output 1 Parameters	Disabled*
<input type="checkbox"/> Output 2 Parameters	Reset Counts
<input type="checkbox"/> Output 3 Parameters	Unlatch Output
<input type="checkbox"/> Quality Output	

The \* indicates that the setting is the default.

To open nested options, **single-click** the +.

To change a setting, **double-click** the setting and use the cursor to scroll through the options.

**Note:** I/O Parameters settings can also be sent to the imager from ESP's Terminal using Microscan's K command format. Refer to the **I/O Parameters** section of **Appendix E**.



## Symbol Data Output

**Symbol Data Output** relates to data and should not be confused with **Outputs 1, 2, and 3** listed in the **Output Parameters** which describe output states and functions.

Useful when the host needs symbol data only under certain conditions.

Defines the conditions under which decoded symbol data is transmitted to the host.

**Note: Symbol Data Output Status**, if set to **Match** or **Mismatch**, will not take effect unless **Matchcode Type** is enabled and a master symbol is loaded into memory.



### Symbol Data Output Status

#### **Disabled**

It is useful when an application only needs to use the discrete outputs and can allow the imager to do the decision-making. When **Disabled**, the host does not need the symbol data and the communication lines are used only for setup and status checks.

When set to **Disabled**, the imager will not transmit any data that is generated during a read cycle (symbols, No Reads, etc.)

#### **Match**

**Match** is used in an application that requires specific symbol information and needs to sort, route, or verify based on matching the specific symbol data.

When set to **Match**, the imager transmits symbol data whenever a symbol matches a master symbol. However, if **Matchcode Type** is **Disabled**, it transmits on any good read.

**Note:** A No Read can still be transmitted if **Enabled**.

#### **Mismatch**

Mismatch is typically used as a flag within the host system to prevent an item from being routed in the wrong container.

With Mismatch enabled, the imager transmits symbol data whenever the symbol data information does NOT match the master symbol.

**Note:** A No Read can still be transmitted if **Enabled**.

#### **Good Read**

**Good Read** is used when an application requires all symbol data to be transmitted. It's typically used in tracking applications in which each object is uniquely identified.

With **Good Read** enabled, the imager transmits symbol data on any good read regardless of **Matchcode Type** setting.

**Note:** A No Read can still be transmitted if **Enabled**.

## When to Output Symbol Data

This command allows the user to choose when symbol data can be sent to the host.

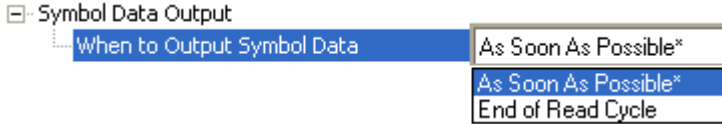

### ***As Soon As Possible***

**As Soon As Possible** is useful in applications in which symbol data needs to be moved quickly to the host, typically when the host is making decisions based on symbol data.

**Note:** More than one decode might in fact be required to qualify as a good read, depending on how **Decodes Before Output** is set.

Enabling **As Soon As Possible** causes symbol data to be sent to the host immediately after a symbol has been successfully decoded.

### ***End of Read Cycle***

**End of Read Cycle** is useful in timing-based systems in which the host is not ready to accept data at the time that it is decoded.

Enabling **End of Read Cycle** means that symbol data does not get sent to the host until the read cycle ends with a timeout or new trigger.

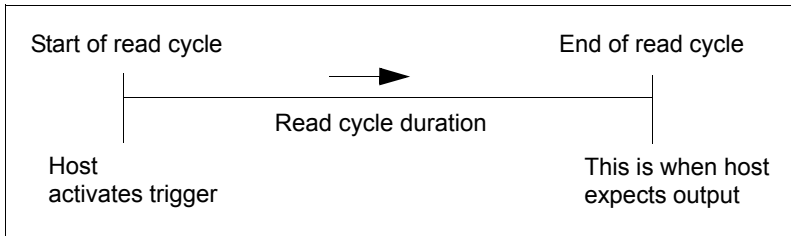

## No Read Message

Used in applications where the host needs serial verification that a symbol has not been read and especially useful in new print verification.

When enabled, and if no symbol has been decoded before timeout or the end of the read cycle, the No Read message will be transmitted to the host.

<input type="checkbox"/> No Read Message	Enabled
Message	NOREAD

## No Read Message Status

### Disabled

Only symbol data is output after a read cycle.

### Enabled

When the imager is in a triggered mode, a No Read message will be appended for each failed read attempt.

## Message

Any combination of ASCII characters can be defined as the No Read message.

**Note:** **No Read Message** will only be transmitted if **Symbol Data Output** is set to **Match**, **Mismatch**, or **Good Read**. **No Read Message** can be set to any ASCII character.

<input type="checkbox"/> No Read Message	Enabled
Message	NOREAD

## Read Duration Output

Useful in evaluating actual read cycle timing results, especially when initially setting up an application to determine maximum line speed (obtainable based on spacing between symbols.)

When enabled the duration of the read cycle (in milliseconds) is appended to the symbol data. The read duration is the time from the beginning of the read cycle until data is output.

**Important:** To measure the entire read cycle when in **External Level** trigger mode, set **When to Output Symbol Data** to **End of Read Cycle**.

This output can measure over 49 days' worth of duration; if exceeded, the "OVERFLOW" message will be output in place of the duration.

Read Duration Output Disabled  
    Separator ,

## Separator

User-defined character that separates the symbol information from the **Read Duration Output**.

Read Duration Output  
    Separator

A character selection dialog box with a text input field at the top containing a comma character. Below the input field is a grid of 30 buttons, each labeled with a control character: NUL, SOH, STX, ETX, EOT, ENQ, ACK, BEL, BS, HT, LF, VT, FF, CR, SO, SI, DLE, DC1, DC2, DC3, DC4, NAK, SYN, ETB, CAN, EM, SUB, ESC, FS, GS, RS, US, SP. At the bottom of the dialog, there is a note: "Click 'Delete' to remove characters."

## Output Indicators

[-] Output Indicators	
Green Flash Mode	Good Read
Targeting	Always On
Green Flash Duration	100
Beeper	Good Read
[-] LED Configuration	
ISO/IEC 16022 Grade	Final Grade

The QX Hawk has a beeper and two LED arrays, as follows:

1. An array of green LEDs projected from the front of the imager that can be programmed to flash in response to user-defined conditions.
2. An array of status LEDs on the side of the imager.

### Green Flash Mode

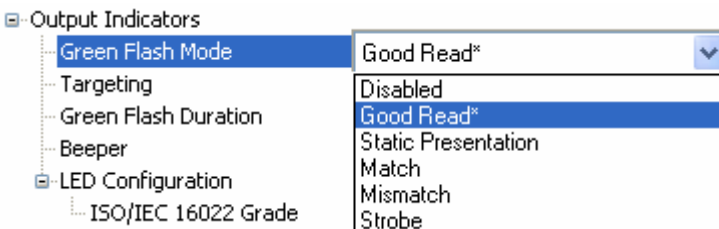

Used as a visual verification that a good read has occurred.

An array of green LEDs in the front of the imager can be programmed to flash in response to user-defined conditions.

#### **Disabled**

Green flash LEDs are disabled.

#### **Good Read**

Green flash LEDs will flash when a good read condition is met or when **Matchcode** is enabled and a match occurs.

### **Static Presentation**

**Static Presentation Mode** is used in conjunction with **Continuous Read** mode.

When operating in **Static Presentation Mode**, the red LEDs will illuminate while the imager is searching for a symbol in **Continuous Read** mode. When a symbol is placed in the field of view and a good read occurs, the green LEDs will illuminate and stay on for the duration of time set in **Green Flash Duration**. Only one read will occur during that time unless more than one symbol is enabled in **Number of Symbols**.

**Note:** If **Static Presentation Mode** is selected but the imager is not in **Continuous Read**, the **Green Flash** will not occur.

#### **To use Static Presentation:**

1. Enable **Continuous Read**.
2. Select the number of symbols.
3. Enable **Static Presentation** in **Green Flash Mode**.
4. Select the read time in **Green Flash Duration**.

### **Match**

The green LEDs will flash when a match condition is met. If multisymbol is enabled, then green flash LEDs will illuminate only if all symbols qualify as a match. If matchcode is disabled, then this mode will activate the LEDs on a good read.

### **Mismatch**

Same as **Match**, except that LEDs will illuminate on a mismatch.

### **Strobe**

The green flash will be used as an illumination strobe for image capture. If it is required that the green flood is the only illumination for image capture then the internal illumination LED's can be disabled.

## Targeting

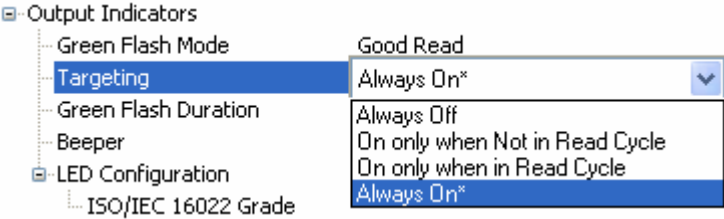

### **Always Off**

The targeting LEDs remain off.

### **On Only When Not In Read Cycle**

The targeting LEDs illuminate while the imager is not in a read cycle. When a read cycle is entered the targeting LEDs will turn off, they will come back on upon exiting.

### **On Only When In Read Cycle**

The targeting LEDs illuminate upon entering a read cycle, and will turn off upon exiting the read cycle.

### **Always On**

The targeting LEDs are always illuminated.

## Green Flash Duration

Provides visual verification that a good read has occurred.

When a good read occurs, the green LEDs will illuminate and stay on for the time set in the **Green Flash Duration** value.

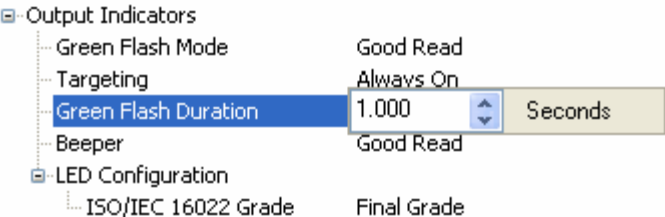

## Beeper

An audible verification that either a good read or a No Read has occurred.

A beep is emitted after each good read or No Read.

**Note:** The beeper will also sound at any of the following times:

- When the imager is defaulted.
- When a **Send and Save** command is sent from ESP.
- At the conclusion of an **Auto Calibration** procedure.
- When a **<Z>**, **<Zrd>**, or **<K701,,1>** command is sent from ESP's Terminal.

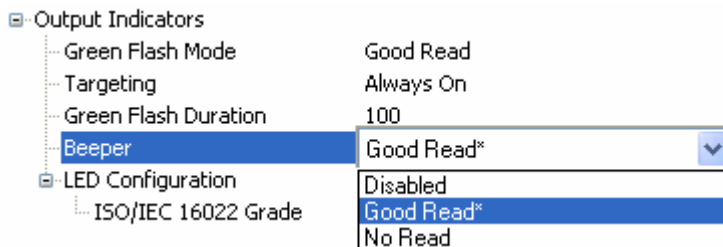



## LED Configuration

When the Symbol Grade Standard is set to ISO/IEC 16022 grade and the Bar Graph is configured for Grading, this parameter determines which ISO/IEC 16022 grade to display on the LED bar graph. Using the read rate scale as reference if the ISO/IEC 16022 grade result was a grade A, all the LEDs from 20% to 100% would be illuminated. If the result was a grade F, only the 20% LED would illuminate.

### ISO/IEC 16022 Grade

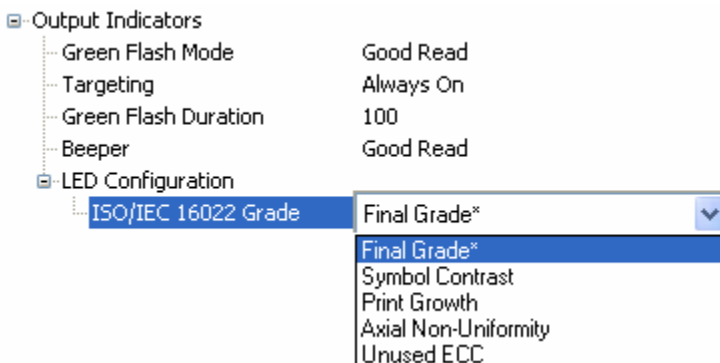

#### Final Grade

LEDs represent ISO/IEC 16022 final grade.

#### Symbol Contrast

LEDs represent ISO/IEC 16022 Symbol Contrast grade.

#### Print Growth

LEDs represent ISO/IEC 16022 Print Growth grade.

#### Axial Non-Uniformity

LEDs represent ISO/IEC 16022 Axial Non-Uniformity grade.

#### Unused ECC

LEDs represent ISO/IEC 16022 Unused ECC grade.

## Serial Verification

Allows the user to verify configuration command status.

Serial Verification	
Serial Command Echo Status	Disabled
Serial Command Beep Status	Disabled
Control/Hex Output	Control

### Serial Command Echo Status

This command is useful in removing any doubt about the imager's interpretation of any configuration command.

For example, if the current preamble is "SOM" and **<K141,1,START>** is entered, the imager will echo back **<K141,SOM>** since the attempted entry "START" exceeds the four character limit for that command. Therefore, it is rejected and the existing "SOM" message is echoed back and remains the preamble message.

When enabled, a configuration command received from the host is echoed back to the host with the resultant settings.

If a command with multiple fields is processed, some of the fields may have been processed properly while others were not. The changes will appear in the string echoed back so that the user will know which fields did or did not change.

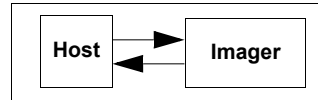

Serial Verification	
Serial Command Echo Status	Disabled*
Serial Command Beep Status	Disabled*
Control/Hex Output	Enabled

### Serial Command Beep Status

Used to audibly verify the acceptance and validity of a command.

Causes the imager to beep once whenever a K command is entered to indicate that the command was accepted and processed.

If an invalid command is entered, the imager beeps 5 times to indicate an invalid entry. However, this does not necessarily mean that all data fields have been entered incorrectly. Only one bad field needs to be found in order to activate the 5 beep response.

Serial Verification	
Serial Command Echo Status	Disabled
Serial Command Beep Status	Disabled*
Control/Hex Output	Disabled*
	Enabled

## Control / Hex Output

Useful for viewing settings with binary characters when using serial commands on a terminal. Determines the response to a **Serial Command Echo** or status request command.

When set to **Control**, two characters are transmitted to represent a non-displayable character. For example, a carriage return will be shown as: **^M**.

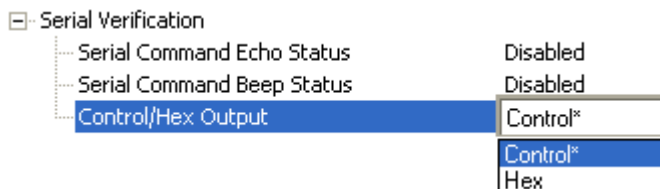

## EZ Trax Output

### EZ Trax Output Status

When EZ Trax output is enabled, the imager will attempt to output all enabled EZ Trax options. EZ Trax will not function unless enabled.

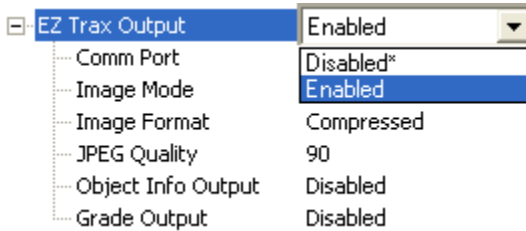

### Comm Port

Selects the communication port that will be used to transfer image files.

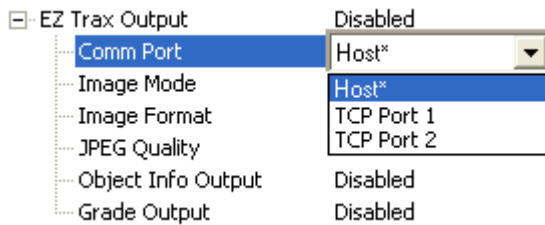

### Image Mode

Determines which read cycle condition triggers image file output.

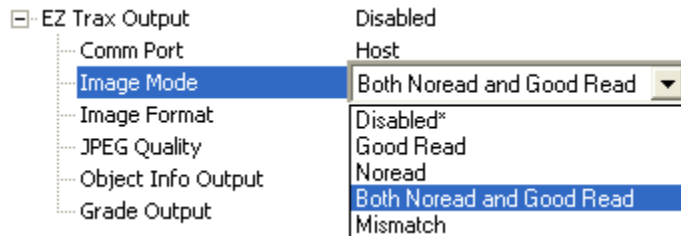

### Image Format

Selects the format of the image output file.

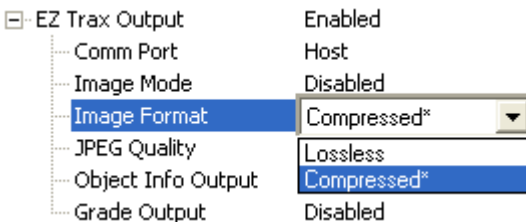

## JPEG Quality

Sets the amount of JPEG image compression. A value of **1** represents the highest compression and lowest image quality, and **100** represents the lowest compression and highest image quality.

EZ Trax Output	Enabled
Comm Port	Host
Image Mode	Disabled
Image Format	Compressed
<b>JPEG Quality</b>	90 (1 - 100) %
Object Info Output	Disabled
Grade Output	Disabled

## Object Info Output

If a symbol is decoded during an image capture, the symbol type and other supplementary symbol information is also included.

EZ Trax Output	Enabled
Comm Port	Host
Image Mode	Disabled
Image Format	Compressed
JPEG Quality	90
<b>Object Info Output</b>	Disabled*
Grade Output	Disabled*
	Enabled

## Grade Output

Symbol quality information will be output in the form of an abbreviated identifier for each read cycle.

EZ Trax Output	Enabled
Comm Port	Host
Image Mode	Disabled
Image Format	Compressed
JPEG Quality	90
Object Info Output	Disabled
<b>Grade Output</b>	Disabled*
	Disabled*
	Enabled

## EZ Button



Serves as a master switch to enable/disable the EZ Button status.

The EZ Button has four positions: **Single Beep**, **Two Beeps**, **Three Beeps**, and **Four Beeps**, selectable by the length of time the button is held down, and indicated by one, two, three, and four beeps in succession. Each position can be programmed for any of eight **EZ Button Modes**.

## EZ Button Status



### **Disabled**

When set to **Disabled**, the EZ Button does not function.

### **Enabled**

When selected, the EZ Button is enabled and the function of each button position is selected by the **EZ Button Modes** command.

### **Trigger**

When selected, the EZ Button acts as a trigger for the imager to start and end read cycles. All other button operations are inactive.

*In External Level:* The read cycle endures for as long as the EZ Button is pressed, unless a timeout occurs and **End of Read Cycle Mode** is set to **Timeout**.

*In External Edge:* As with **External Level**, **External Edge** allows a read cycle to be initiated by pressing the EZ Button, but unlike **External Level**, the read cycle ends with a good read output, a timeout, or a new trigger.

### **Unlatch Outputs**

In this configuration, the EZ Button will unlatch any logic outputs that have been latched.

### **Parameter Switch**

The parameter switch toggles between custom defaults and power-on settings. The condition is the same as that achieved by sending the **<Arc>** and **<Arp>** commands consecutively.

### Default on Power-On

When enabled, if the EZ Button is held down on power-on, the imager will default to customer defaults and save for power-on. This is the same as sending a **<Zrc>** command from ESP's Terminal.

Default On Power-on	Enabled*
	Disabled
	Enabled*

### Load Configuration Database

Loads Configuration Database settings to the imager.

Load Config DB	Enabled*	▼
	Disabled	
	Enabled*	

### Save for Power-On

Saves imager settings for Power-On.

Save For Power-on	Disabled*	▼
	Disabled*	
	Enabled	



## EZ Button Modes

Useful for performing multiple, repetitive tasks at the work site.

Allows the user to program each of the EZ Button's 4 positions from a selection of 7 modes.

### **Single Beep**

Hold down button until a single beep is heard.

### **Disabled**

When set to **Disabled**, the associated button position will have no function associated with it, and the position will be skipped over.

### **Read Rate**

**Read Rate** is initiated when the associated button position is selected. Read Rate will perform decodes/second and is the same as sending a **<C>** from ESP's Terminal. To exit Read Rate, quickly press and release the EZ Button.

### **Calibrate**

**Calibrate** is initiated when the associated button position is selected. To cancel Calibration, quickly press and release the EZ Button.

### **Save for Power-On**

All imager settings will be saved to non-volatile memory to be recalled on power-on whenever the associated button position is selected. This is the same as sending a **<Z>** from ESP's Terminal.

### **Load New Master**

Functions in the same way as **New Master Pin** input whenever the associated button position is selected.

### **Target System (Default)**

When the imager reaches this position, the targeting pattern appears. The targeting pattern remains illuminated even if a different position is subsequently selected until this position selection is disabled. To turn the targeting pattern off, quickly press and release the EZ Button.

### **Bar Code Configuration**

Enables **Bar Code Configuration Mode** whenever the associated button position is selected. When enabled, the imager can accept configuration commands from symbols. To disable, quickly press and release the EZ Button.

---

## I/O Parameters

### **Two Beeps**

Hold down button until two beeps are heard.

### **Disabled**

When set to **Disabled**, the associated button position will have no function associated with it, and the position will be skipped over.

### **Read Rate**

**Read Rate** is initiated when the associated button position is selected. Read Rate will perform decodes/second and is the same as sending a **<C>** from ESP's Terminal. To exit Read Rate, quickly press and release the EZ Button.

### **Calibrate (Default)**

**Calibrate** is initiated when the associated button position is selected. To cancel Calibration, quickly press and release the EZ Button.

### **Save for Power-On**

All imager settings will be saved to non-volatile memory to be recalled on power-on whenever the associated button position is selected. This is the same as sending a **<Z>** from ESP's Terminal.

### **Load New Master**

Functions in the same way as **New Master Pin** input whenever the associated button position is selected.

### **Target System**

When the imager reaches this position, the targeting pattern appears. The targeting pattern remains illuminated even if a different position is subsequently selected until this position selection is disabled. To turn the targeting pattern off, quickly press and release the EZ Button.

### **Bar Code Configuration**

Enables **Bar Code Configuration Mode** whenever the associated button position is selected. When enabled, the imager can accept configuration commands from symbols. To disable, quickly press and release the EZ Button.

### **Three Beeps**

Hold down button until three beeps are heard.

### **Disabled**

When set to **Disabled**, the associated button position will have no function associated with it, and the position will be skipped over.

### **Read Rate (Default)**

**Read Rate** is initiated when the associated button position is selected. Read Rate will perform decodes/second and is the same as sending a **<C>** from ESP's Terminal. To exit Read Rate, quickly press and release the EZ Button.

### **Calibrate**

**Calibrate** is initiated when the associated button position is selected. To cancel Calibration, quickly press and release the EZ Button.

### **Save for Power-On**

All imager settings will be saved to non-volatile memory to be recalled on power-on whenever the associated button position is selected. This is the same as sending a **<Z>** from ESP's Terminal.

### **Load New Master**

Functions in the same way as **New Master Pin** input whenever the associated button position is selected.

### **Target System**

When the imager reaches this position, the targeting pattern appears. The targeting pattern remains illuminated even if a different position is subsequently selected until this position selection is disabled. To turn the targeting pattern off, quickly press and release the EZ Button.

### **Bar Code Configuration**

Enables **Bar Code Configuration Mode** whenever the associated button position is selected. When enabled, the imager can accept configuration commands from symbols. To disable, quickly press and release the EZ Button.

---

## I/O Parameters

### **Four Beeps**

Hold down button until four beeps are heard.

### **Disabled**

When set to **Disabled**, the associated button position will have no function associated with it, and the position will be skipped over.

### **Read Rate**

**Read Rate** is initiated when the associated button position is selected. Read Rate will perform decodes/second and is the same as sending a **<C>** from ESP's Terminal. To exit Read Rate, quickly press and release the EZ Button.

### **Calibrate**

**Calibrate** is initiated when the associated button position is selected. To cancel Calibration, quickly press and release the EZ Button.

### **Save for Power-On (Default)**

All imager settings will be saved to non-volatile memory to be recalled on power-on whenever the associated button position is selected. This is the same as sending a **<Z>** from ESP's Terminal.

### **Load New Master**

Functions in the same way as **New Master Pin** input whenever the associated button position is selected.

### **Target System**

When the imager reaches this position, the targeting pattern appears. The targeting pattern remains illuminated even if a different position is subsequently selected until this position selection is disabled. To turn the targeting pattern off, quickly press and release the EZ Button.

### **Bar Code Configuration**

Enables **Bar Code Configuration Mode** whenever the associated button position is selected. When enabled, the imager can accept configuration commands from symbols. To disable, quickly press and release the EZ Button.

## Status Indicators

The QX Hawk features an array of LEDs that indicate various aspects of imager activity.



- [-] Status Indicators
  - Bar Graph
  - I/O 1
  - I/O 2



- PHY Activity
- Read Rate / Good Read
- Output Active
- Input Active

Controls the operation of the MOD/ACT and NET/LNK LEDs.

- [-] Status Indicators
    - Bar Graph
    - I/O 1
    - I/O 2
- |                   |
|-------------------|
| PHY Activity*     |
| Disabled          |
| PHY Activity*     |
| Protocol Activity |

### Disabled

When set to **Disabled**, the MOD/ACT and NET/LNK LEDs are always off.

**Note:** All green and red LEDs will turn on briefly during power-on or reset to confirm that they are functioning.

### PHY Activity

**If Ethernet is available:**

**LNK** = Solid green when transceiver is linked.

**ACT** = Blinking green when transceiver detects Tx or Rx activity.

**Otherwise, for all RS-232 and RS-422/485 activity:**

**LNK** = Blinking green with Tx data activity.

**ACT** = Blinking green with Rx data activity.

**Note:** Red is never turned on.

### Protocol Activity

**If EtherNet/IP is enabled:**

**MOD** = Module status, per EtherNet/IP specification

**NET** = Network status, per EtherNet/IP specification

Otherwise, the MOD and NET LEDs are always off.

## I/O Parameters

### Bar Graph

Read Rate, Auto Calibration, Bar Code Configuration, and Read Cycle Result all share the Bar Graph (20% – 100%) LEDs.

☐ Status Indicators	PHY Activity
Bar Graph	Read Rate / Good Read*
I/O 1	Disabled
I/O 2	Read Rate / Good Read*
	Symbol Grade

### I/O 1

I/O 1 always shows the combined state of the discrete outputs. If any output is active, the I/O 1 LED will be on.

☐ Status Indicators	PHY Activity
Bar Graph	Read Rate
I/O 1	Output Active*
I/O 2	Disabled
	Output Active*
	Input Active

### I/O 2

I/O 2 always shows the state of the hardware input trigger. If the trigger is active, I/O 2 will be on.

☐ Status Indicators	PHY Activity
Bar Graph	Read Rate
I/O 1	Output Active
I/O 2	Input Active*
	Disabled
	Output Active
	Input Active*

## Calibration Options

This command specifies the operation of the calibration feature. The default configuration is setup to perform calibration on gain, focus and symbol type. Shutter speed is disabled as the default setting, since shutter speed is more of an application specific parameter and normally should be configured by the user to meet the requirements of the application. The calibration process will optimize the gain setting for the configured shutter speed (Camera).

**Note:** Background color (Reverse Video) is part of the calibration process, regardless of the calibration setup. After successful completion of calibration, the background color will be set to the appropriate value depending on the calibrated symbol. The mirrored image parameter is not part of the calibration process, and must be configured appropriately by the user prior to calibration (Mirrored Image).

Calibration Options	
Gain	Calibrate
Shutter Speed	Don't Calibrate
Focus Position	Calibrate
Symbol Type	Calibrate
Window of Interest Framing	Don't Calibrate
Window of Interest Margin	75

### Gain

#### Disabled

The gain is fixed and is not part of the calibration process.

#### Enabled

The gain will be calibrated to provide the best image quality and performance.

Calibration Options	
Gain	Calibrate*
Shutter Speed	Don't Calibrate
Focus Position	Calibrate*
Symbol Type	Calibrate
Window of Interest Framing	Don't Calibrate
Window of Interest Margin	75

## Shutter Speed

Unless an application is a static setup, the shutter speed setting should be configured by the user based on their application. For dynamic applications the user should configure the shutter speed setting, so the calibration process can optimize the gain for that setting. The following table illustrates a general guide-line for shutter speed configurations for various line speeds.

**Note:** This is a general guide line, and depends on the scanners optical configuration and symbol element size.

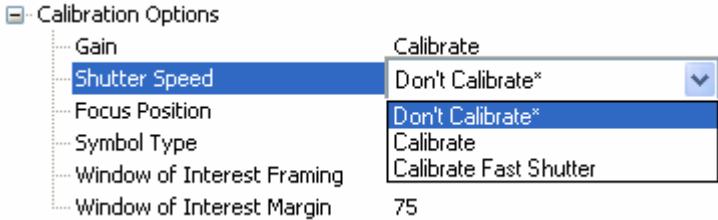

### **Don't Calibrate**

The shutter speed is fixed and is not part of the calibration process.

### **Calibrate**

The shutter speed will be calibrated to provide the best image quality and performance.

### **Calibrate Fast Shutter**

The calibration process will concentrate on achieving the fastest possible shutter setting that still will still have good performance. The image quality or contrast may not be as good as what would be achieved with the "Enabled" setting. The calibration process is not designed to choose the fastest shutter speed that can decode a symbol, but rather to optimize for the fastest shutter speed that still provides good image quality.



## Focus Position (Standard QX Hawk Only)

Since the focus can be configured by simply entering the target distance value from the imager, normally the user will configure the focus without requiring calibration. However, if it is necessary to calibrate the focus distance there are two methods to accommodate this task.

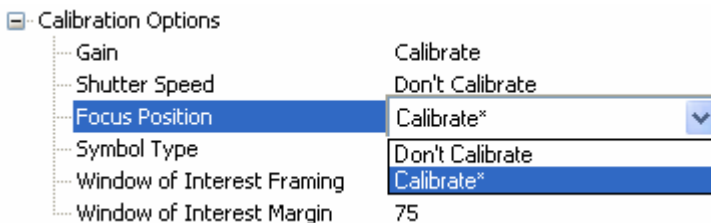

### **Don't Calibrate**

The focus position is fixed and is not part of the calibration process.

### **Calibrate**

The focus position will be calibrated to provide the best image quality and performance. This method is a simply "Search" method that tries to identify the desired focus through a search algorithm that cycles through focus settings, with a configuration of camera settings to try and locate as quickly as possible the desired focus. This is accomplished when a symbol is decoded. Once a focus distance has been located that will successfully decode a symbol, the algorithm will fine tune the search to locate the inside and outside focal distances. The final focus distance is selected as the focus distance that is in the center of these two values. This method can be time consuming if the focus is not found on the 1st pass.

## Symbol Type

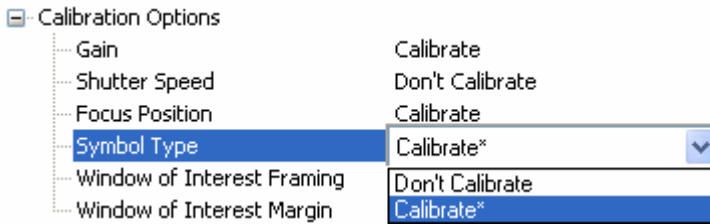

### **Don't Calibrate**

Only the current symbologies enabled will be considered during the calibration process.

### **Calibrate**

Autodiscrimination is in effect during the calibration process. All symbologies readable by the product, except PDF417 and Pharmacode will be attempted during calibration. Any new symbologies successfully decode during calibration will remain enabled at the end of the process. All enabled symbologies will remain enabled. For example, assume that only Code 39 is enabled at the beginning of calibration. If a Code 128 symbol is read during calibration, then Code 128 as well as Code 39 will thereafter be enabled.

## Window of Interest Framing

If a WOI framing mode is enabled, when calibration begins it will set the camera WOI to a full size image. Once a symbol is decoded, the camera WOI will be zoomed in both vertically and horizontally (regardless which WOI mode is enabled) to include the symbol plus an additional margin. This is done to speed up the calibration process. When calibration completes, and is successful, then the camera WOI will be adjusted according to the mode enabled. Otherwise, the original WOI configuration will be retained.

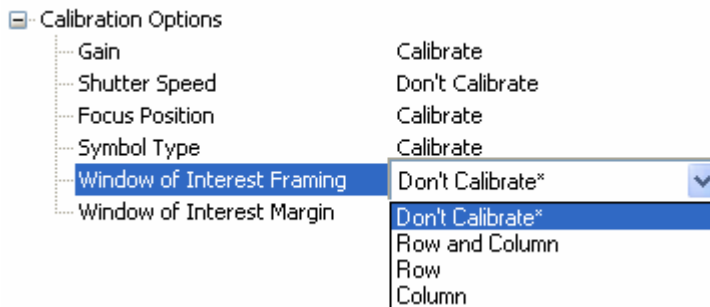

### **Don't Calibrate**

The Window of Interest is not modified after the completion of Calibration.

## Row and Column

If the calibration process is successful the Window of Interest will be modified to frame the symbol plus an addition margin area around the symbol, determined by the “WOI margin” parameter.

### Row

If the calibration process is successful the Window of Interest rows will be modified to horizontally frame the symbol plus an addition margin determined by the “WOI margin” parameter.

### Column

If the calibration process is successful the Window of Interest columns will be modified to vertically frame the symbol plus an addition margin determined by the “WOI margin” parameter.

## Window of Interest Margin

Sets the margin size that is applied to the calibrated label, and is specified in number of pixels. If margin causes image to exceed maximum image size, it will be reduced accordingly.

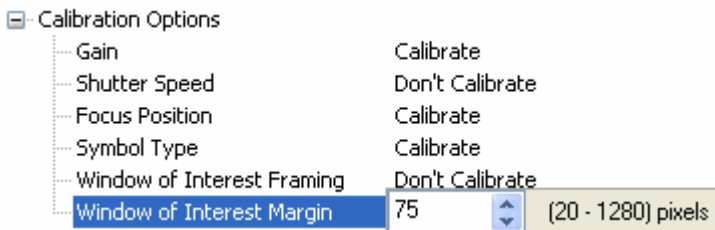

## Database Identifier Output

Useful in tracking which database entries read which symbols.

### Database Identifier Output Status

Database Identifier Output      Disabled  
    Separator Character              SP

#### Disabled

When this command is disabled, no database identifier information will be output.

#### Enabled

When this command is enabled, the imager will append a two-digit number and the characters “DB” to the data output following the separator for each symbol decoded using **Configuration Database**. For example, if the separator is an underscore character and the second database entry reads a symbol encoded with “data capture” during the read cycle, the symbol data output will be “data capture\_DB02”. If the database is not active, no identifiers will be attached to output.

### Separator Character

The separator character separates the symbol data from the database identifier.

Database Identifier Output      Disabled  
    Separator Character

SP

NUL	SOH	STX	ETX	EOT	ENQ
ACK	BEL	BS	HT	LF	VT
FF	CR	SO	SI	DLE	DC1
DC2	DC3	DC4	NAK	SYN	ETB
CAN	EM	SUB	ESC	FS	GS
RS	US	SP			

Click 'Delete' to remove characters.

## Input 1

Input 1 Disabled  
Active State Active Open

### Input Mode

Determines the function of the Input pin.

Input 1 Disabled\*  
Active State Disabled\*  
Reset Counts  
Unlatch Output

#### **Disabled**

When set to **Disabled**, the Input pin has no impact on operation.

#### **Reset Counts**

When set to **Reset Counts**, a transition to the active state of the Input will cause the imager to reset the internal counters.

#### **Unlatch Output**

This setting is used in combination with any of the three outputs in **Latch Mode 1 (Unlatch Input # 1 Pin)**. A transition to the active state will clear any of the three outputs that were previously latched.

### Active State

Input 1 Disabled  
Active State Active Open\*  
Active Open\*  
Active Closed

#### **Active Open**

Input function is activated when input state is de-energized.

#### **Active Closed**

Input function is activated when input state is energized.

## Output 1 Parameters

### Output On

**Output On** provides discrete signalling to host software to control external devices such as PLCs and relays. It is useful for routing, sorting, and to prevent mis-packaging and mis-routing.

Sets the discrete output functions for specific user-selected conditions. Allows the user to set the conditions under which an output (or outputs) will be activated.

**Note:** If **Output On** is set to any mode containing **Match** or **Mismatch**, the transition (switching) will only occur if **Matchcode Type** is enabled and **Master Symbol(s)** are loaded into memory.

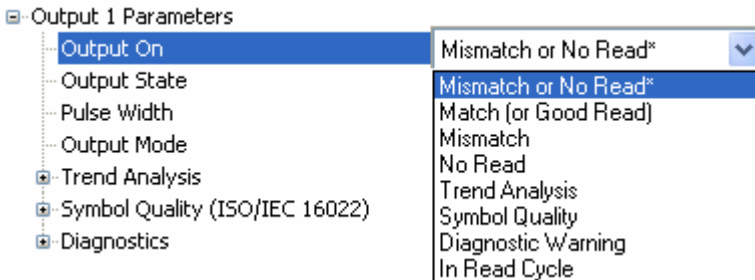

### Mismatch or No Read

Activates a discrete output when the data does not match that of the master symbol or the symbol has not been decoded before the end of the read cycle.

### Match (or Good Read)

Activates a discrete output when the symbol data matches the master symbol.

### Mismatch

Activates a discrete output whenever the symbol data does not match that of the master symbol.

### No Read

Activates a discrete output whenever the symbol data is not decoded before the end of the read cycle.

### Trend Analysis

Typically used when successful decodes are occurring but a discrete output is needed to flag a trend in quality issues.

Activates a discrete output when a trend analysis condition is met, depending on the trend analysis option enabled.

### Symbol Quality

Activates a discrete output if the quality of a symbol in the read cycle falls below the thresholds set in [Symbol Quality \(ISO/IEC 16022\)](#).

***Diagnostic Warning***

Typically used when a discrete indication of a diagnostic condition is needed.

Activates discrete output when a diagnostic warning condition is met, depending on the diagnostic option enabled.

***In Read Cycle***

Activates a discrete output when the imager is in a read cycle. This feature bypasses the pulse width and latch options.

## Output State

Sets the active electrical state of the discrete output.



## Pulse Width

Sets the time that the discrete output remains active.

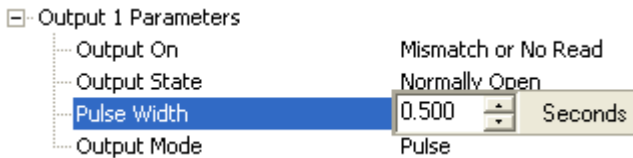

## Output Mode

Sets the condition in which the discrete output is de-activated.

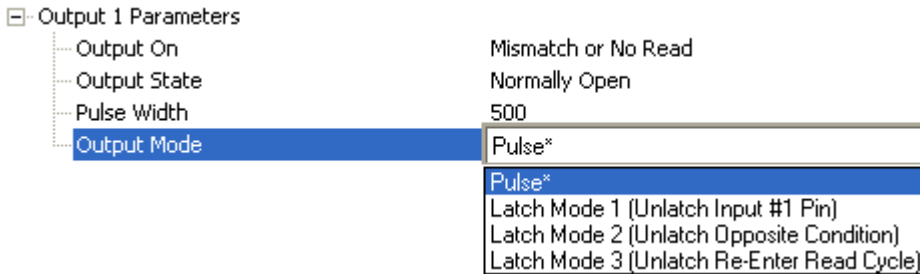

## Pulse

This is the default mode of operation in which the programmable output is activated when the **Output On** condition has been met and held active for the duration of the selected pulse width.

### Latch Mode 1 (Unlatch Input # 1 Pin)

The programmable output is activated when the **Output On** condition has been met and held active until the **Input # 1 Pin** transitions.

**Note:** **Input 1** must be set to **Unlatch Output** for Latch Mode 1 to function.

If the Output Condition is set to **Read Cycle Data Valid**, then the read cycle will wait for Input 1 to unlatch the output before continuing on. This is to provide system handshake ability despite communication channel. The read cycle data must leave all channels before **Read Cycle Data Valid** will output.



### ***Latch Mode 2 (Unlatch Opposite Condition)***

The programmable output is activated when the **Output On** condition has been met and held active until the opposite condition selected under **Output On** has been met.

For example, if **No Read** is enabled under **Output On**, the programmable output will go active on a No Read and remain active until the opposite condition, a good read, occurs.

If the Output Condition is set to **Read Cycle Data Valid**, then the read cycle will continue but every new **Read Cycle Data Valid** event causes the output to change state to the opposite condition. This provides a toggle event per every read cycle output. The only known output state will be the on a power-on or reset. After reading begins, the state becomes undetermined. Only the state change itself has meaning—not the absolute value.

### ***Latch Mode 3 (Unlatch Re-enter Read Cycle)***

The programmable output is activated when the **Output On** condition has been met and held active until a new read cycle begins.

**Note:** All of the **Output On** modes are inhibited when any **Diagnostic Warning** is active for **Output 1**.

## Trend Analysis

**Note:** **Output On** under **Output 1 Parameters** must be set to **Trend Analysis** for this output to function.

Under **Output 1 Parameters**, expand the **Trend Analysis** tree.

Useful in cases where the user doesn't want to shut down for one condition but wants to monitor quality and read conditions.

Applies **Trend Analysis** settings to **Output 1**.

With **Trend Analysis**, the user can track the occurrences and frequency of mismatches, No Reads, and the number of reads per trigger, and output the results to any of three outputs.

**Trend Analysis Mode** = No Read

**Trigger Evaluation Period** = 25 triggers (read cycles)

**Number to Output On** = 4

In this example, the imager will activate an output when 4 No Reads occur within a period of 25 triggers (read cycles).

### Trend Analysis Mode

Sets the trend condition (**Mismatch**, **No Read**, **Decodes per Trigger**, **Bad Symbol**, or **No Symbol**) that will activate the output.

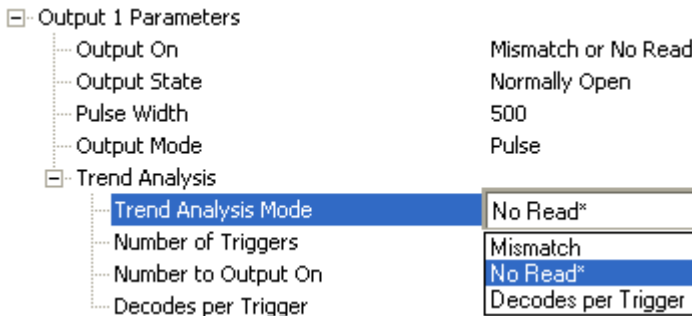

### Mismatch

Output will be activated when the number of mismatches equals the value entered for **Number to Output On** within the trigger window selected in **Number of Triggers**.

### No Read

Output will be activated when the number of No Reads equals the value entered for **Number to Output On** within the trigger window selected in **Number of Triggers**.

### Decodes per Trigger

Output will be activated when the number of decodes equals the value entered for **Number to Output On** within the trigger window selected in **Number of Triggers**.

## Number of Triggers

The number of triggers to examine for the trend analysis condition.

[-] Output 1 Parameters	
Output On	Mismatch or No Read
Output State	Normally Open
Pulse Width	500
Output Mode	Pulse
[-] Trend Analysis	
Trend Analysis Mode	No Read
Number of Triggers	0 (0 - 255)
Number to Output On	0
Decodes per Trigger	0

## Number to Output On

*Example:* If **Number to Output On** is set to 3 and **Trend Analysis Mode** is set to **No Read**, then the output will not be activated until 3 No Reads have occurred.

Sets the number of **Trend Analysis Mode** events (mismatches, No Reads, or reads/trigger as configured by **Trend Analysis Mode**) to occur within the trigger evaluation period before activating the associated output.

[-] Output 1 Parameters	
Output On	Mismatch or No Read
Output State	Normally Open
Pulse Width	500
Output Mode	Pulse
[-] Trend Analysis	
Trend Analysis Mode	No Read
Number of Triggers	0
Number to Output On	0 (0 - 255)
Decodes per Trigger	0

### **Decodes per Trigger**

When set to this mode, and when the appropriate output is set to output on trend analysis, the imager will function in a **Decodes per Trigger** mode during the read cycle and the trend analysis operation. Output will be activated based on whether or not the symbol decode count at the end of the read cycle is less than the decodes per trigger threshold.

**Note:** Although this setup causes the imager to function in a **Decodes per Trigger** mode, the decode count will only be appended to the symbol data if the status of the **Decodes per Trigger** command is enabled.

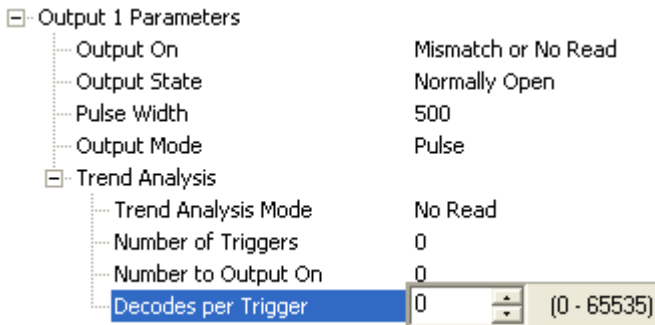

*Example:*

Decodes per Trigger threshold: 100

100 or more decodes = No output

Fewer than 100 decodes = Output fires

## Symbol Quality (ISO/IEC 16022)

▣ Symbol Quality (ISO/IEC 16022)	
Output on Symbol Contrast	Disabled
Output on Print Growth	Disabled
Output on Axial Non-uniformity	Disabled
Output on Unused ECC	Disabled
Symbol Contrast Threshold	Grade C
Print Growth Threshold	Grade C
Axial Non-uniformity Threshold	Grade C
Unused ECC Threshold	Grade C

### ***Output on Symbol Contrast***

The symbol contrast is formatted and attached to the Data Matrix symbol data as either a grade or value.

Output on Symbol Contrast	Disabled*	▼
	Disabled*	
	Enabled	

### ***Output on Print Growth***

The print growth is formatted and attached to the Data Matrix symbol data as either a grade or value.

Output on Print Growth	Disabled*	▼
	Disabled*	
	Enabled	

### ***Output on Axial Non-Uniformity***

The axial non-uniformity is formatted and attached to the Data Matrix symbol data as either a grade or value.

Output on Axial Non-uniformity	Disabled*	▼
	Disabled*	
	Enabled	

### ***Output On Unused ECC***

The unused ECC is formatted and attached to the Data Matrix symbol data as either a grade or value.

Output on Unused ECC	Disabled*	▼
	Disabled*	
	Enabled	

### **Symbol Contrast Threshold**

This is the grade to use as a threshold for driving the output. Output will be driven if the Symbol Contrast grade is under the threshold.

Symbol Contrast Threshold	Grade C* 
	Grade A
	Grade B
	Grade C*
	Grade D

### **Print Growth Threshold**

This is the grade to use as a threshold for driving the output. Output will be driven if the Print Growth grade is under the threshold.

Print Growth Threshold	Grade C* 
	Grade A
	Grade B
	Grade C*
	Grade D

### **Axial Non-Uniformity Threshold**

This is the grade to use as a threshold for driving the output. Output will be driven if the Axial Non-Uniformity grade is under the threshold.

Axial Non-uniformity Threshold	Grade C* 
	Grade A
	Grade B
	Grade C*
	Grade D

### **Unused ECC Threshold**

This is the grade to use as a threshold for driving the output. Output will be driven if the Unused ECC grade is under the threshold.

Unused ECC Threshold	Grade C* 
	Grade A
	Grade B
	Grade C*
	Grade D

## Diagnostics

**Note:** **Output On** under **Output 1 Parameters** must be set to **Diagnostic Warning** for this output to function.

Under **Output 1 Parameters**, expand the **Diagnostics** tree.

When **Diagnostic Warning** is enabled, the **Output On** configuration has no effect. The output will remain active as long as one of the diagnostic warning conditions is met. The output will become inactive once it detects that there are no diagnostic warning conditions.

### Service Unit

Allows the user to set up the output to toggle to active when the service timer has expired. This condition will only be held for one service timer click.

**Note:** This feature cannot be used if the imager is in **Continuous Read**.

When **Service Unit** is enabled, a message of up to 10 ASCII characters is sent whenever the system detects that the service timer's limit has been reached. The service timer is reset at power-on, meaning that the service timer's limit is the amount of time since last reset. Service timer increments can be set in seconds or minutes.



## Output 2 Parameters

Output 2 has the same parameters and default settings as Output 1.

### Output On

Output On provides discrete signalling to host software to control external devices such as PLCs and relays. It is useful for routing, sorting, and to prevent mis-packaging and mis-routing.

Sets the discrete output functions for specific user-selected conditions. Allows the user to set the conditions under which an output (or outputs) will be activated.

**Note:** If Output On is set to **Match** or **Mismatch**, a transition (switching) will not occur unless **Matchcode Type** is enabled and a master symbol is loaded into memory.

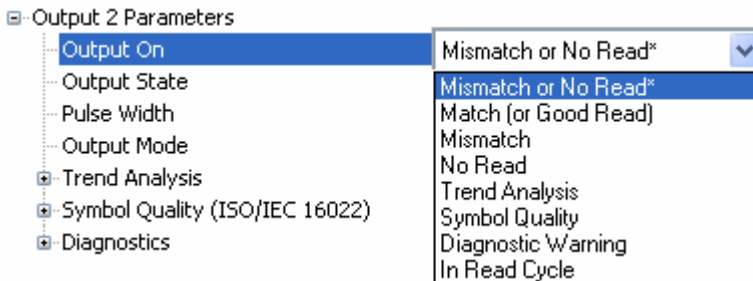

### Mismatch or No Read

Activates discrete output when the data does not match that of the master symbol or the symbol has not been decoded before the end of the read cycle.

### Good Read / Match

Activates a discrete output when the symbol data matches the master symbol.

**Note:** To output on **Good Read** when **Matchcode** is not enabled, enable any output for **Match**.

### Mismatch

Activates a discrete output whenever the symbol data does not match that of the master symbol.

### No Read

Activates a discrete output whenever the symbol data is not decoded before the end of the read cycle.

### Trend Analysis

Typically used when successful decodes are occurring but a discrete output is needed to flag a trend in quality issues.

Activates discrete output when a trend analysis condition is met, depending on the trend analysis option enabled.



### ***Symbol Quality***

Activates a discrete output if the quality of a symbol in the read cycle falls below the thresholds set in [Symbol Quality \(ISO/IEC 16022\)](#).

### ***Diagnostic Warning***

Typically used when a discrete indication of a diagnostic condition is needed.

Activates discrete output when a diagnostic warning condition is met, depending on the diagnostic option enabled.

### ***In Read Cycle***

Activates a discrete output when the imager is in a read cycle. This feature bypasses the pulse width and latch options.

## Output State

Sets the active electrical state of the discrete output.



## Pulse Width

Sets the time in 10 ms increments that the discrete output remains active.



## Output Mode

Sets the condition in which the discrete output is de-activated.

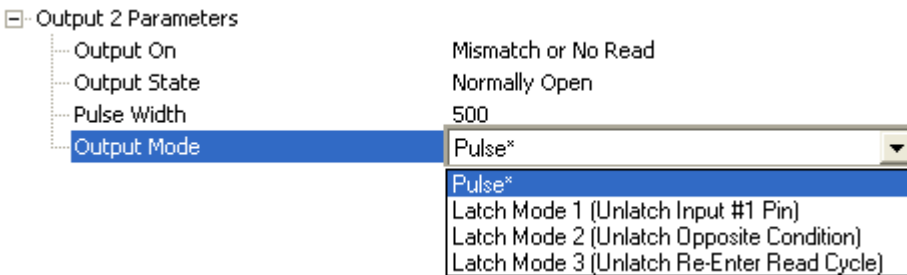

### **Pulse**

This is the default mode of operation in which the programmable output is activated when the **Output On** condition has been met and held active for the duration of the selected pulse width.

### **Latch Mode 1 (Unlatch Input # 1 Pin)**

The programmable output is activated when the **Output On** condition has been met and held active until the **Input # 1 Pin**.

**Note:** Input 1 must be set to **Unlatch Output** for Latch Mode 1 to function.

If the Output Condition is set to **Read Cycle Data Valid**, then the read cycle will wait for Input 1 to unlatch the output before continuing on. This is to provide system handshake ability despite communication channel. The read cycle data must leave all channels before **Read Cycle Data Valid** will output.

### ***Latch Mode 2 (Unlatch Opposite Condition)***

The programmable output is activated when the **Output On** condition has been met and held active until the opposite condition selected under **Output On** has been met.

For example, if **No Read** is enabled under **Output On**, the programmable output will go active on a No Read and remain active until the opposite condition, a good read, occurs.

If the Output Condition is set to **Read Cycle Data Valid**, then the read cycle will continue but every new **Read Cycle Data Valid** event causes the output to change state to the opposite condition. This provides a toggle event per every read cycle output. The only known output state will be the on a power-on or reset. After reading begins, the state becomes undetermined. Only the state change itself has meaning—not the absolute value.

### ***Latch Mode 3 (Unlatch Re-enter Read Cycle)***

The programmable output is activated when the **Output On** condition has been met and held active until a new read cycle begins.

**Note:** All of the **Output On** modes are inhibited when any **Diagnostic Warning** is active for **Output 2**.

## Trend Analysis

**Note:** **Output On** under **Output 2 Parameters** must be set to **Trend Analysis** for this output to function.

Under **Output 2 Parameters**, expand the **Trend Analysis** tree.

Useful in cases where the user doesn't want to shut down for one condition but wants to monitor quality and read conditions.

Applies **Trend Analysis** settings to **Output 2**.

With **Trend Analysis**, the user can track the occurrences and frequency of mismatches, No Reads, and the number of reads per trigger, and output the results to any of three outputs.

**Trend Analysis Mode** = No Read

**Trigger Evaluation Period** = 25 triggers (read cycles)

**Number to Output On** = 4

In this example, the imager will activate an output when 4 No Reads occur within a period of 25 triggers (read cycles).

### Trend Analysis Mode

Sets the trend condition (**Mismatch**, **No Read**, **Decodes per Trigger**, **Bad Symbol**, or **No Symbol**) that will activate the output.

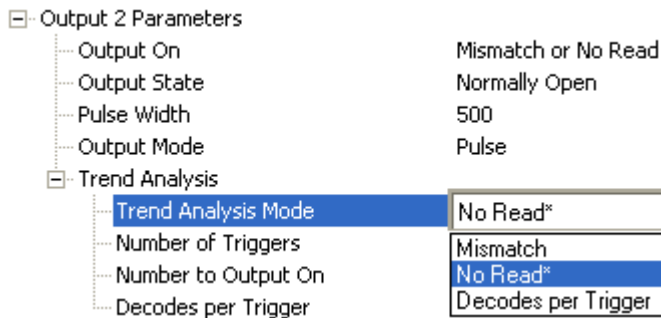

### Mismatch

Output will be activated when the number of mismatches equals the value entered for **Number to Output On** within the trigger window selected in **Number of Triggers**.

### No Read

Output will be activated when the number of No Reads equals the value entered for **Number to Output On** within the trigger window selected in **Number of Triggers**.

### Decodes per Trigger

Output will be activated when the number of decodes equals the value entered for **Number to Output On** within the trigger window selected in **Number of Triggers**.

## Number of Triggers

The number of triggers to examine for the trend analysis condition.

[-] Output 2 Parameters	
Output On	Mismatch or No Read
Output State	Normally Open
Pulse Width	500
Output Mode	Pulse
[-] Trend Analysis	
Trend Analysis Mode	No Read
Number of Triggers	0 (0 - 255)
Number to Output On	0
Decodes per Trigger	0

## Number to Output On

*Example:* If **Number to Output On** is set to 3 and **Trend Analysis Mode** is set to **No Read**, then the output will not be activated until 3 No Reads have occurred.

Sets the number of **Trend Analysis Mode** events (mismatches, No Reads, or reads/trigger as configured by **Trend Analysis Mode**) to occur within the trigger evaluation period before activating the associated output.

[-] Output 2 Parameters	
Output On	Mismatch or No Read
Output State	Normally Open
Pulse Width	500
Output Mode	Pulse
[-] Trend Analysis	
Trend Analysis Mode	No Read
Number of Triggers	0
Number to Output On	0 (0 - 255)
Decodes per Trigger	0

### Decodes per Trigger

When set to this mode, and when the appropriate output is set to output on trend analysis, the imager will function in a **Decodes per Trigger** mode during the read cycle and the trend analysis operation. Output will be activated based on whether or not the symbol decode count at the end of the read cycle is less than the decodes per trigger threshold.

**Note:** Although this setup causes the imager to function in a **Decodes per Trigger** mode, the decode count will only be appended to the symbol data if the status of the **Decodes per Trigger** command is enabled.

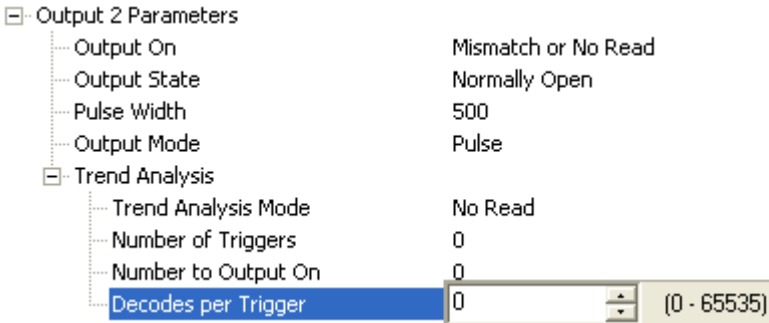

*Example:*

Decodes per Trigger threshold: 100

100 or more decodes = No output

Fewer than 100 decodes = Output fires

## Symbol Quality (ISO/IEC 16022)

Symbol Quality (ISO/IEC 16022)	
Output on Symbol Contrast	Disabled
Output on Print Growth	Disabled
Output on Axial Non-uniformity	Disabled
Output on Unused ECC	Disabled
Symbol Contrast Threshold	Grade C
Print Growth Threshold	Grade C
Axial Non-uniformity Threshold	Grade C
Unused ECC Threshold	Grade C

### Output on Symbol Contrast

The symbol contrast is formatted and attached to the Data Matrix symbol data as either a grade or value.

A screenshot of a software interface showing a dropdown menu for the parameter 'Output on Symbol Contrast'. The menu is currently set to 'Disabled\*' and is open, showing two options: 'Disabled\*' (highlighted) and 'Enabled'.

### Output on Print Growth

The print growth is formatted and attached to the Data Matrix symbol data as either a grade or value.

A screenshot of a software interface showing a dropdown menu for the parameter 'Output on Print Growth'. The menu is currently set to 'Disabled\*' and is open, showing two options: 'Disabled\*' (highlighted) and 'Enabled'.

### Output on Axial Non-Uniformity

The axial non-uniformity is formatted and attached to the Data Matrix symbol data as either a grade or value.

A screenshot of a software interface showing a dropdown menu for the parameter 'Output on Axial Non-uniformity'. The menu is currently set to 'Disabled\*' and is open, showing two options: 'Disabled\*' (highlighted) and 'Enabled'.

### Output On Unused ECC

The unused ECC is formatted and attached to the Data Matrix symbol data as either a grade or value.

A screenshot of a software interface showing a dropdown menu for the parameter 'Output on Unused ECC'. The menu is currently set to 'Disabled\*' and is open, showing two options: 'Disabled\*' (highlighted) and 'Enabled'.

### **Symbol Contrast Threshold**

This is the grade to use as a threshold for driving the output. Output will be driven if the Symbol Contrast grade is under the threshold.

Symbol Contrast Threshold	Grade C* 
	Grade A
	Grade B
	Grade C*
	Grade D

### **Print Growth Threshold**

This is the grade to use as a threshold for driving the output. Output will be driven if the Print Growth grade is under the threshold.

Print Growth Threshold	Grade C* 
	Grade A
	Grade B
	Grade C*
	Grade D

### **Axial Non-Uniformity Threshold**

This is the grade to use as a threshold for driving the output. Output will be driven if the Axial Non-Uniformity grade is under the threshold.

Axial Non-uniformity Threshold	Grade C* 
	Grade A
	Grade B
	Grade C*
	Grade D

### **Unused ECC Threshold**

This is the grade to use as a threshold for driving the output. Output will be driven if the Unused ECC grade is under the threshold.

Unused ECC Threshold	Grade C* 
	Grade A
	Grade B
	Grade C*
	Grade D



## Diagnostics

**Note:** **Output On** under **Output 2 Parameters** must be set to **Diagnostic Warning** for this output to function.

Under **Output 2 Parameters**, expand the **Diagnostics** tree.

When **Diagnostic Warning** is enabled, the **Output On** configuration has no effect. The output will remain active as long as one of the diagnostic warning conditions is met. The output will become inactive once it detects that there are no diagnostic warning conditions.

### Service Unit

Allows the user to set up the output to toggle to active when the service timer has expired. This condition will only be held for one service timer click.

**Note:** This feature cannot be used if the imager is in **Continuous Read**.

When **Service Unit** is enabled, a message of up to 10 ASCII characters is sent whenever the system detects that the service timer's limit has been reached. The service timer is reset at power-on, meaning that the service timer's limit is the amount of time since last reset. Service timer increments can be set in seconds or minutes.



## Output 3 Parameters

**Output 3** has the same parameters and default settings as **Output 1** and **Output 2**.

**Note:** If you are using a QX Hawk C-Mount and **External Illumination Mode** is enabled, the parameters for **Output On**, **Pulse Width**, and **Output Mode** are ignored.

### Output On

**Output On** provides discrete signalling to host software to control external devices such as PLCs and relays. It is useful for routing, sorting, and to prevent mis-packaging and mis-routing.

Sets the discrete output functions for specific user-selected conditions. Allows the user to set the conditions under which an output (or outputs) will be activated.

**Note:** If **Output On** is set to **Match** or **Mismatch**, a transition (switching) will not occur unless **Matchcode Type** is enabled and a master symbol is loaded into memory.

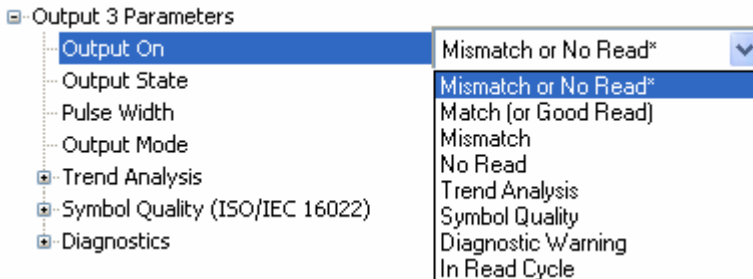

### Mismatch or No Read

Activates discrete output when the data does not match that of the master symbol or the symbol has not been decoded before the end of the read cycle.

### Good Read / Match

Activates a discrete output when the symbol data matches the master symbol.

**Note:** To output on **Good Read** when **Matchcode** is not enabled, enable any output for **Match**.

### Mismatch

Activates a discrete output whenever the symbol data does not match that of the master symbol.

### No Read

Activates a discrete output whenever the symbol data is not decoded before the end of the read cycle.

### Trend Analysis

Typically used when successful decodes are occurring but a discrete output is needed to flag a trend in quality issues.

Activates discrete output when a trend analysis condition is met, depending on the trend analysis option enabled.

### ***Symbol Quality***

Activates a discrete output if the quality of a symbol in the read cycle falls below the thresholds set in [Symbol Quality \(ISO/IEC 16022\)](#).

### ***Diagnostic Warning***

Typically used when a discrete indication of a diagnostic condition is needed.

Activates discrete output when a diagnostic warning condition is met, depending on the diagnostic option enabled.

### ***In Read Cycle***

Activates a discrete output when the imager is in a read cycle. This feature bypasses the pulse width and latch options.

## Output State

Sets the active electrical state of the discrete output.

**Note: Normally Closed** is the default for the QX Hawk C-Mount.

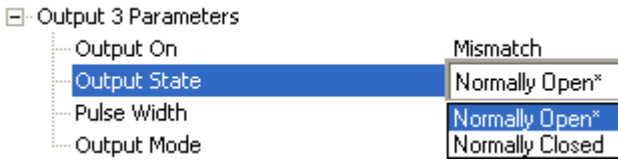

## Pulse Width

Sets the time in 1 ms increments that the discrete output remains active.



## Output Mode

Sets the condition in which the discrete output is de-activated.

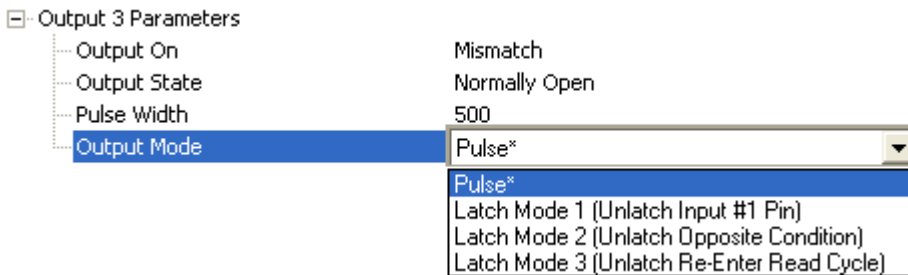

## Pulse

This is the default mode of operation in which the programmable output is activated when the **Output On** condition has been met and held active for the duration of the selected pulse width.

### Latch Mode 1 (Unlatch Input # 1 Pin)

The programmable output is activated when the **Output On** condition has been met and held active until the **Input # 1 Pin**.

**Note: Input 1** must be set to **Unlatch Output** for Latch Mode 1 to function.

If the Output Condition is set to **Read Cycle Data Valid**, then the read cycle will wait for Input 1 to unlatch the output before continuing on. This is to provide system handshake ability despite communication channel. The read cycle data must leave all channels before **Read Cycle Data Valid** will output.

### ***Latch Mode 2 (Unlatch Opposite Condition)***

The programmable output is activated when the **Output On** condition has been met and held active until the opposite condition selected under **Output On** has been met.

For example, if **No Read** is enabled under **Output On**, the programmable output will go active on a No Read and remain active until the opposite condition, a good read, occurs.

If the Output Condition is set to **Read Cycle Data Valid**, then the read cycle will continue but every new **Read Cycle Data Valid** event causes the output to change state to the opposite condition. This provides a toggle event per every read cycle output. The only known output state will be the on a power-on or reset. After reading begins, the state becomes undetermined. Only the state change itself has meaning—not the absolute value.

### ***Latch Mode 3 (Unlatch Re-enter Read Cycle)***

The programmable output is activated when the **Output On** condition has been met and held active until a new read cycle begins.

**Note:** All of the **Output On** modes are inhibited when any **Diagnostic Warning** is active for **Output 3**.

## Trend Analysis

**Note:** **Output On** under **Output 3 Parameters** must be set to **Trend Analysis** for this output to function.

Under **Output 3 Parameters**, expand the **Trend Analysis** tree.

Useful in cases where the user doesn't want to shut down for one condition but wants to monitor quality and read conditions.

Applies **Trend Analysis** settings to **Output 3**.

With **Trend Analysis**, the user can track the occurrences and frequency of mismatches, No Reads, and the number of reads per trigger, and output the results to any of three outputs.

**Trend Analysis Mode** = No Read

**Trigger Evaluation Period** = 25 triggers (read cycles)

**Number to Output On** = 4

In this example, the imager will activate an output when 4 No Reads occur within a period of 25 triggers (read cycles).

### Trend Analysis Mode

Sets the trend condition (**Mismatch**, **No Read**, **Decodes per Trigger**, **Bad Symbol**, or **No Symbol**) that will activate the output.

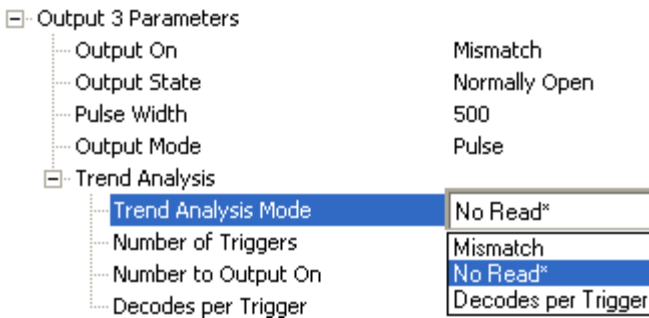

### Mismatch

Output will be activated when the number of mismatches equals the value entered for **Number to Output On** within the trigger window selected in **Number of Triggers**.

### No Read

Output will be activated when the number of No Reads equals the value entered for **Number to Output On** within the trigger window selected in **Number of Triggers**.

### Decodes per Trigger

Output will be activated when the number of decodes equals the value entered for **Number to Output On** within the trigger window selected in **Number of Triggers**.

## Number of Triggers

The number of triggers to examine for the trend analysis condition.

[-] Output 3 Parameters	
Output On	Mismatch
Output State	Normally Open
Pulse Width	500
Output Mode	Pulse
[-] Trend Analysis	
Trend Analysis Mode	No Read
Number of Triggers	0 (0 - 255)
Number to Output On	0
Decodes per Trigger	0

## Number to Output On

*Example:* If **Number to Output On** is set to 3 and **Trend Analysis Mode** is set to **No Read**, then the output will not be activated until 3 No Reads have occurred.

Sets the number of **Trend Analysis Mode** events (mismatches, No Reads, or reads/trigger as configured by **Trend Analysis Mode**) to occur within the trigger evaluation period before activating the associated output.

[-] Output 3 Parameters	
Output On	Mismatch
Output State	Normally Open
Pulse Width	500
Output Mode	Pulse
[-] Trend Analysis	
Trend Analysis Mode	No Read
Number of Triggers	0
Number to Output On	0 (0 - 255)
Decodes per Trigger	0

### ***Decodes per Trigger***

When set to this mode, and when the appropriate output is set to output on trend analysis, the imager will function in a **Decodes per Trigger** mode during the read cycle and the trend analysis operation. Output will be activated based on whether or not the symbol decode count at the end of the read cycle is less than the decodes per trigger threshold.

**Note:** Although this setup causes the imager to function in a **Decodes per Trigger** mode, the decode count will only be appended to the symbol data if the status of the **Decodes per Trigger** command is enabled.

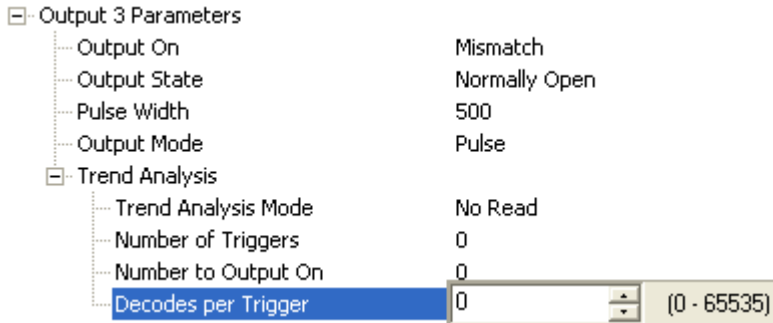

***Example:***

Decodes per Trigger threshold: 100

100 or more decodes = No output

Fewer than 100 decodes = Output fires



## Symbol Quality (ISO/IEC 16022)

☐ Symbol Quality (ISO/IEC 16022)	
... Output on Symbol Contrast	Disabled
... Output on Print Growth	Disabled
... Output on Axial Non-uniformity	Disabled
... Output on Unused ECC	Disabled
... Symbol Contrast Threshold	Grade C
... Print Growth Threshold	Grade C
... Axial Non-uniformity Threshold	Grade C
... Unused ECC Threshold	Grade C

### ***Output on Symbol Contrast***

The symbol contrast is formatted and attached to the Data Matrix symbol data as either a grade or value.

Output on Symbol Contrast	Disabled*	▼
	Disabled*	
	Enabled	

### ***Output on Print Growth***

The print growth is formatted and attached to the Data Matrix symbol data as either a grade or value.

Output on Print Growth	Disabled*	▼
	Disabled*	
	Enabled	

### ***Output on Axial Non-Uniformity***

The axial non-uniformity is formatted and attached to the Data Matrix symbol data as either a grade or value.

Output on Axial Non-uniformity	Disabled*	▼
	Disabled*	
	Enabled	

### ***Output On Unused ECC***

The unused ECC is formatted and attached to the Data Matrix symbol data as either a grade or value.

Output on Unused ECC	Disabled*	▼
	Disabled*	
	Enabled	

### Symbol Contrast Threshold

This is the grade to use as a threshold for driving the output. Output will be driven if the Symbol Contrast grade is under the threshold.

Symbol Contrast Threshold	Grade C* 
	Grade A
	Grade B
	Grade C*
	Grade D

### Print Growth Threshold

This is the grade to use as a threshold for driving the output. Output will be driven if the Print Growth grade is under the threshold.

Print Growth Threshold	Grade C* 
	Grade A
	Grade B
	Grade C*
	Grade D

### Axial Non-Uniformity Threshold

This is the grade to use as a threshold for driving the output. Output will be driven if the Axial Non-Uniformity grade is under the threshold.

Axial Non-uniformity Threshold	Grade C* 
	Grade A
	Grade B
	Grade C*
	Grade D

### Unused ECC Threshold

This is the grade to use as a threshold for driving the output. Output will be driven if the Unused ECC grade is under the threshold.

Unused ECC Threshold	Grade C* 
	Grade A
	Grade B
	Grade C*
	Grade D

## Diagnostics

**Note:** **Output On** under **Output 3 Parameters** must be set to **Diagnostic Warning** for this output to function.

Under **Output 3 Parameters**, expand the **Diagnostics** tree.

When **Diagnostic Warning** is enabled, the **Output On** configuration has no effect. The output will remain active as long as one of the diagnostic warning conditions is met. The output will become inactive once it detects that there are no diagnostic warning conditions.

### Service Unit

Allows the user to set up the output to toggle to active when the service timer has expired. This condition will only be held for one service timer click.

**Note:** This feature cannot be used if the imager is in **Continuous Read**.

When **Service Unit** is enabled, a message of up to 10 ASCII characters is sent whenever the system detects that the service timer's limit has been reached. The service timer is reset at power-on, meaning that the service timer's limit is the amount of time since last reset. Service timer increments can be set in seconds or minutes.



## Quality Output

- [-] Quality Output
  - Quality Output Separator ,
  - Decodes/Trigger Status Disabled
  - Decode Direction Output Disabled

### Quality Output Separator

The separator character separates quality output data from symbol data.

- [-] Quality Output
  - Quality Output Separator
  - Decodes/Trigger Status
  - Decode Direction Output

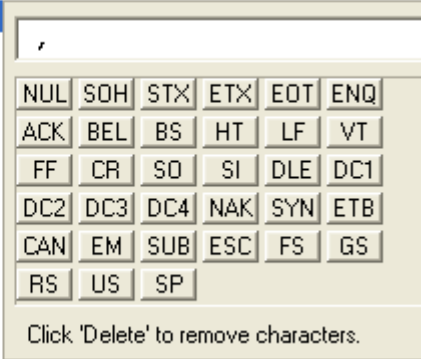

A character selection dialog box with a text input field at the top containing a comma character. Below the input field is a grid of buttons representing ASCII control characters. The buttons are arranged in six rows: Row 1: NUL, SOH, STX, ETX, EDT, ENQ; Row 2: ACK, BEL, BS, HT, LF, VT; Row 3: FF, CR, SO, SI, DLE, DC1; Row 4: DC2, DC3, DC4, NAK, SYN, ETB; Row 5: CAN, EM, SUB, ESC, FS, GS; Row 6: RS, US, SP. Below the grid, there is a note: "Click 'Delete' to remove characters."

### Decodes per Trigger Status

When Enabled, the imager enters a state where it processes frames as configured until the end of a read cycle, with or without a successful symbol decode. When the read cycle ends, the imager outputs any decoded symbol data along with the decodes per trigger count.

- [-] Quality Output
  - Quality Output Separator
  - Decodes/Trigger Status Disabled\*
  - Decode Direction Output Disabled\*

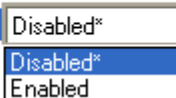

A dropdown menu with three options: "Disabled\*", "Disabled\*", and "Enabled". The "Enabled" option is currently selected and highlighted in blue.

# Symbol Quality

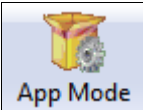

Click the **App Mode** button and then the **Parameters** button to display the tree control tabs. Then click the **Symbol Quality** tab to display the Symbol Quality tree control.

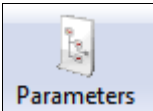

Parameters	ESP Values
[-] Symbol Quality	
[-] Global	
Total Read Time	Disabled
Symbol Quality Separator	SP
Output Mode	Grade
[-] Data Matrix	
+ ISO/IEC 16022 Parameters	
[-] Grading	
Percent Cell Damage	Disabled
Capture Time	Disabled
Locate Time	Disabled*
Decode Time	Disabled*
Pixels Per Element	Enabled
ECC Level	Disabled
Matrix Size	Disabled
Quiet Zone	Disabled
Symbol Angle	Disabled

The \* indicates that the setting is the default.

To open nested options, **single-click** the +.

To change a setting, **double-click** the setting and use the cursor to scroll through the options.

**Note:** Symbol Quality settings can also be sent to the imager from ESP’s Terminal using Microscan’s K command format.

## Global

Global	
Total Read Time	Disabled
Symbol Quality Separator	SP
Output Mode	Grade

### Total Read Time

When enabled, outputs the amount of time that was required by the imager to decode the symbol.

Global	
Total Read Time	Disabled*
Symbol Quality Separator	Disabled*
Output Mode	Enabled

### Symbol Quality Separator

This field specifies the separator used to separate the quality output data.

Global	
Total Read Time	Disabled
Symbol Quality Separator	SP
Output Mode	

NUL	SOH	STX	ETX	EOT	ENQ
ACK	BEL	BS	HT	LF	VT
FF	CR	SO	SI	DLE	DC1
DC2	DC3	DC4	NAK	SYN	ETB
CAN	EM	SUB	ESC	FS	GS
RS	US	SP			

Click 'Delete' to remove characters.

### Output Mode

Determines how symbol quality evaluations will be output.

Global	
Total Read Time	Disabled
Symbol Quality Separator	SP
Output Mode	Grade*

## Data Matrix

[-] Data Matrix		
[-] ISO/IEC 16022 Parameters		
Symbol Contrast		Disabled
Print Growth		Disabled
Axial Non-uniformity		Disabled
Unused ECC		Disabled
[-] Grading		
Percent Cell Damage		Disabled
Capture Time		Disabled
Locate Time		Disabled
Decode Time		Disabled
Pixels Per Element		Disabled
ECC Level		Disabled
Matrix Size		Disabled
Quiet Zone		Disabled
Symbol Angle		Disabled

### ISO/IEC 16022 Parameters

[-] ISO/IEC 16022 Parameters		
Symbol Contrast		Disabled
Print Growth		Disabled
Axial Non-uniformity		Disabled
Unused ECC		Disabled

#### **Symbol Contrast**

Outputs the candidate symbol's Symbol Contrast value.

#### **Print Growth**

Outputs the candidate symbol's Print Growth value.

#### **Axial Non-Uniformity**

Outputs the candidate symbol's Axial Non-Uniformity value.

#### **Unused ECC**

Outputs the candidate symbol's Unused ECC value.

## Grading

<input type="checkbox"/> Grading	
Percent Cell Damage	Disabled
Capture Time	Disabled
Locate Time	Disabled
Decode Time	Disabled
Pixels Per Element	Disabled
ECC Level	Disabled
Matrix Size	Disabled
Quiet Zone	Disabled
Symbol Angle	Disabled

### ***Percent Cell Damage***

The percent of symbol cells that are damaged.

### ***Capture Time***

The amount of time the imager required to capture the area in which the symbol was located.

### ***Locate Time***

The amount of time the imager required to locate the symbol.

### ***Decode Time***

The amount of time the imager required to decode the symbol.

### ***Pixels Per Element***

The average number of pixels in a symbol element.

### ***ECC Level***

The level of error correction used when decoding the symbol.

### ***Matrix Size***

The size of the symbol's matrix area (the area composed of the symbol's elements).

### ***Quiet Zone***

The size of the quiet zone around the symbol.

### ***Symbol Angle***

The angle at which the symbol is printed or marked.



## Report Tab

The **Report** tab allows the user to initiate **Data Matrix Grading** and to generate and save grading reports.

To save the report as a PDF file, an HTML file, a CSV file, or an RTF file, click the **Save Report** button.

Reports appear in the viewing area underneath the **Data Matrix Grading** and **Save Report** buttons.

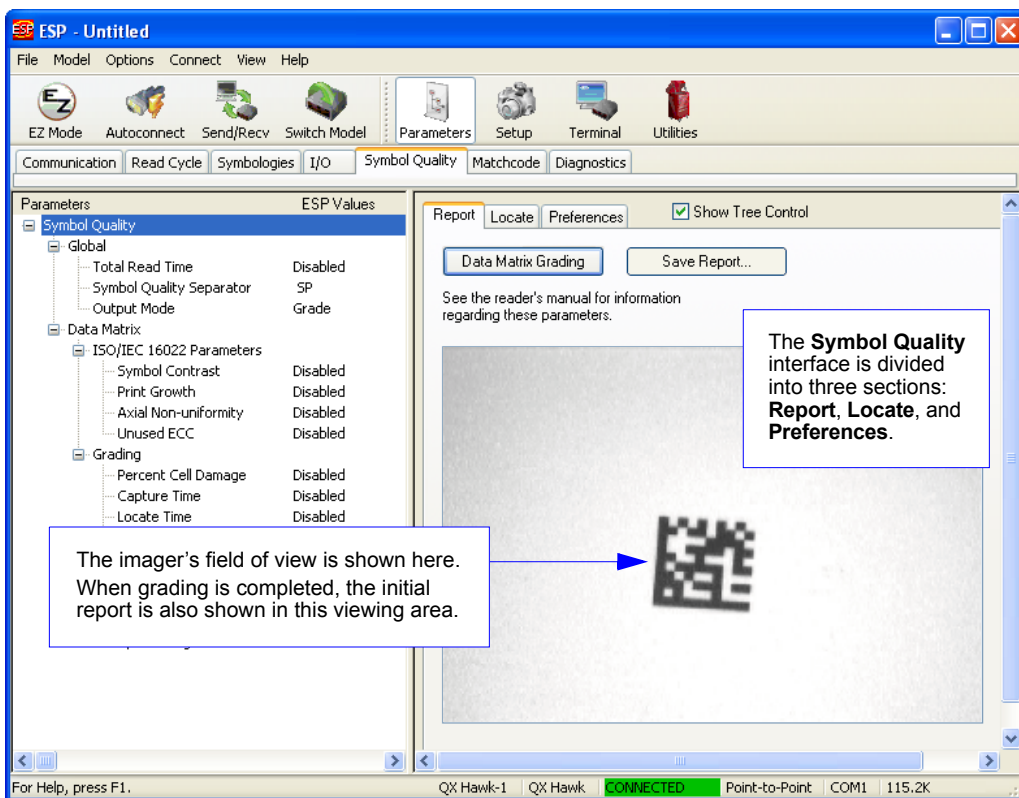

## Locate Tab

The **Locate** tab allows the user to determine the position of the symbol within the imager's field of view, and to optimize the imager's camera settings for symbol quality evaluation.

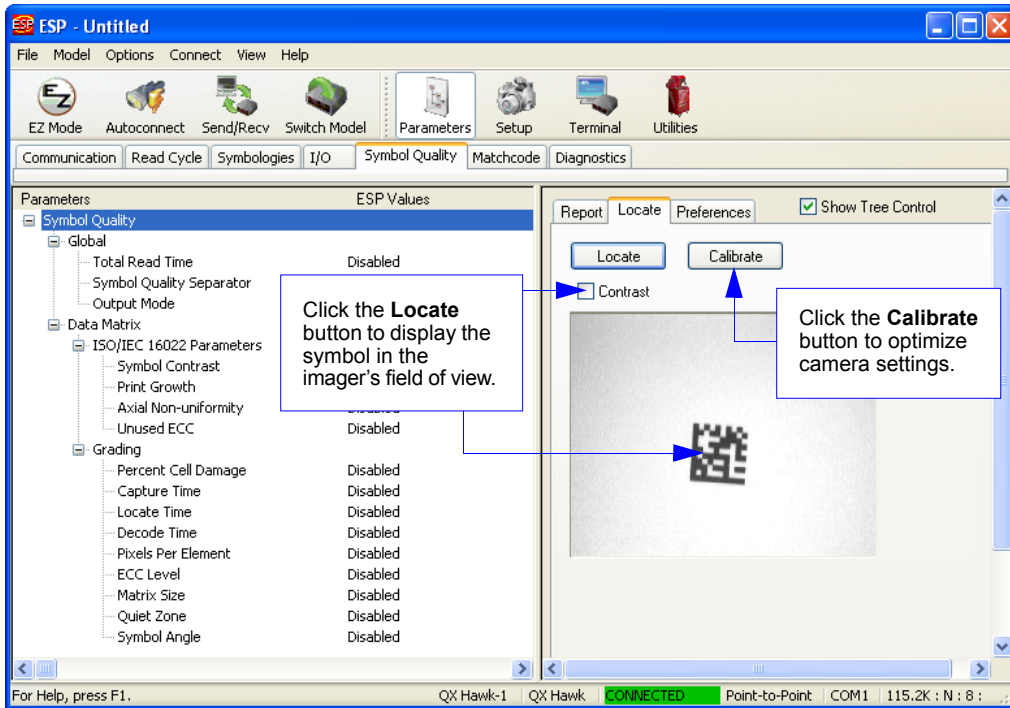

## Preferences Tab

The **Preferences** tab allows the user to set defaults that are automatically activated when grading is completed. For this reason, the user is advised to set preferences before performing grading.

The screenshot shows the Preferences dialog box with the following sections and callouts:

- Report | Locate | Preferences** (Tabs) and  Show Tree Control
- Fields for report**
  - Operator Name: J. Doe
  - Company Name: XYZ Corp.
  - Callout: This information is appended at the bottom of the report.
- Saved Options**
  - Show Report Options dialog during 'Save Report'.
  - Default Report Type: PDF Files (\*.pdf)
    - Callout: Choose the default report type to be generated when you click **Save Report** on the **Report** tab. Check **Autofit Content** to ensure that saved PDF report content will fit on a single page.
    - Dropdown menu options: PDF Files (\*.pdf), HTML Files (\*.htm), CSV Files (\*.csv), Rich Text Edit Files (\*.rtf)
  - Autofit Content
  - Low Graphic HTML
  - Append to file
  - Store Report without file path prompt
    - Callout: Typically you will be asked where you wish to store your report. If you do not want to be prompted to choose a file path, click **Store Report without file path prompt**.
  - Use symbol data for file name
  - Default Path: C:\Documents and Settings\symbols grades
  - Automatically open generated report
  - Print after saving
  - Include Image
    - Callout: Click the **Include Image** check box to output the captured symbol image with your saved report as a Bitmap or JPEG image file.
  - Radio buttons:  Bitmap,  JPEG
  - JPEG Image Quality: 100 (range 1 - 100)
- Overall Grade Based On**
  - Symbol Contrast
  - Print Growth
  - Axial Nonuniformity
  - Unused ECC
  - Enable UII Parsing
    - Callout: Enables ESP to parse UII symbol data into the correct fields and output order defined by the U.S. Department of Defense IUID initiative.
- Buttons**
  - Default Settings: Returns all settings to default.
  - Revert Settings: Returns all settings to most recent.

# Matchcode

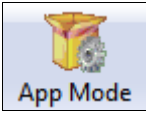

Click the **App Mode** button and then the **Parameters** button to display the tree control tabs. Then click the **Matchcode** tab to display the Matchcode tree control.

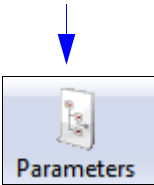

Parameters	ESP Values
[-] Matchcode	
Matchcode Type	Disabled
Sequential Matching	Increment
Match Start Position	0
Match Length	1
Wild Card	*
Sequence on No Read	Enabled
Sequence on Mismatch	Disabled
Sequence Step	1
New Master Pin	Disabled
[-] Match Replace	Disabled
Replacement String	MATCH
[-] Mismatch Replace	Disabled*
Replacement String	Disabled*
	Enabled

The \* indicates that the setting is the default.

To open nested options, **single-click** the +.

To change a setting, **double-click** the setting and use the cursor to scroll through the options.

**Note:** Matchcode settings can also be sent to the imager from ESP's Terminal using Microscan's K command format. Refer to the **Matchcode** section of **Appendix E**.

## Overview of Matchcode

**Matchcode** allows the user to store master symbol data in the imager's memory, compare that data against other symbol data, and define how symbol data and/or discrete signal output will be directed.

A master symbol database can be set up for up to 10 master symbols.

**Note:** **Matchcode** will function with multiple symbols; however, if **Matchcode Type** is set to **Sequential** or if **Trigger Mode** is set to **Continuous Read 1 Output**, the imager will behave as if **Number of Symbols** were set to 1, regardless of the user-defined configuration.

Matchcode is used in applications to sort, route, or verify data based on matching the specific symbol in a variety of ways as defined in this section. For example, a manufacturer might sort a product based on dates that are embedded in the symbol.

## Steps for Entering and Using Master Symbols

1. Set **Trigger Mode** to **External Level**, **External Edge**, or **Serial Data**.
2. Choose the method of symbol comparison that fits the application.
3. Define the type of output required with Matchcode setup:
  - a. Symbol data output
  - b. Discrete output
4. Select the number of master symbols required.
5. Decide how the master symbol(s) will be entered:
  - a. Use ESP to type master symbol data directly.
  - b. Send a serial command with symbol data in the form of **<K231, master symbol#, data>**.
  - c. Send a **<G>** (Read Next Symbol as Master Symbol) command.
  - d. Enable the **New Master Pin** command and activate the discrete input to store the next symbol read as the master symbol.

## Matchcode Type

Allows the user to choose the way that master symbols will be compared with subsequently read symbols.

**Note:** First set **Trigger Mode** to **External Level**, **External Edge**, or **Serial Data**.

[-] Matchcode	
Matchcode Type	Disabled*
Sequential Matching	Disabled*
Match Start Position	Enabled
Match Length	Wild Card
Wild Card	Sequential
Sequence on No Read	Enabled
Sequence on Mismatch	Disabled
Sequence Step	1
New Master Pin	Disabled

## Wild Card

Allows the user to enter user-defined wild card characters in the master symbol.

**Note:** If **Matchcode Type** is set to **Sequential**, the imager will behave as if **Number of Symbols** were set to **1**, regardless of the user-defined configuration.

## Sequential

Instructs the imager to compare symbols or portions of symbols with the master symbol.

Instructs the imager to sequence after each match (numeric only) and compare symbols or portions of symbols for sequential numbers.

## Sequential Matching

Useful in tracking product serial numbers that increment or decrement sequentially.

With Sequential enabled, Sequential Matching determines if a count is in ascending (incremental) or descending (decremental) order.

[-] Matchcode	
Matchcode Type	Disabled
Sequential Matching	Increment*
Match Start Position	Increment*
Match Length	Decrement
Wild Card	*
Sequence on No Read	Enabled
Sequence on Mismatch	Disabled
Sequence Step	1
New Master Pin	Disabled

## Match Start Position

**Match Start Position** is useful in defining specific portions of a symbol for comparison. For example, if a symbol contains a part number, manufacturing date, and lot code info, but only the part number information is needed, set the imager to sort only the part number and to ignore the other characters.

**Match Start Position** determines the portions of symbols that will be matched by defining the first character in the symbol (from left to right) that will be compared with those of the master symbol, when **Matchcode Type** is set to **Enabled** or **Sequential**.

For example, if **Match Start Position** is set to **3**, the first 2 characters read in the symbol will be ignored and only the 3rd and subsequent characters to the right will be compared, up to the number of characters specified by **Match Length**.

**Note: Match Start Position** must be set to **1** or greater to enable this feature. A **0** setting will disable this feature.

[-] Matchcode

Matchcode Type	Disabled
Sequential Matching	Increment
Match Start Position	0 (0 - 3000)
Match Length	1
Wild Card	*
Sequence on No Read	Enabled
Sequence on Mismatch	Disabled
Sequence Step	1
New Master Pin	Disabled

## Match Length

*Example:* If **Match Length** is set to **6** in a 10-character symbol, and **Match Start Position** is set to **2**, only the 2nd through 7th characters (from left to right) will be compared.

Defines the length of the character string that will be compared with that of the master symbol when **Match Start Position** is set to **1** or greater. When **Match Start Position** is set to **0**, no comparison will occur.

[-] Matchcode

Matchcode Type	Disabled
Sequential Matching	Increment
Match Start Position	0
Match Length	1 (1 - 3000)
Wild Card	*
Sequence on No Read	Enabled
Sequence on Mismatch	Disabled
Sequence Step	1
New Master Pin	Disabled

## Wild Card

*Example:* With **Wild Card Character** defined as the default asterisk, defining **CR\*34** as the master symbol will result in matches for CR134 and CR234, but not CR2345. Entering the wild card at the end of the master symbol, as in **CR\***, will result in matches for variable symbol lengths such as CR1, CR23, CR**358**, etc.

Wild Card Character allows a user to define a wild card character as part of the master symbol.

The image shows a configuration window for Matchcode. On the left is a tree view with the following items: Matchcode (expanded), Matchcode Type (Disabled), Sequential Matching (Increment), Match Start Position (0), Match Length (1), Wild Card (selected), Sequence on No Read, Sequence on Mismatch, Sequence Step, and New Master Pin. The Wild Card selection dialog is open, showing a text field with an asterisk (\*) and a grid of control characters. The grid contains: NUL, SOH, STX, ETX, EOT, ENQ; ACK, BEL, BS, HT, LF, VT; FF, CR, SO, SI, DLE, DC1; DC2, DC3, DC4, NAK, SYN, ETB; CAN, EM, SUB, ESC, FS, GS; RS, US, SP. Below the grid is the instruction: Click 'Delete' to remove characters.



## Sequence on No Read

**Sequence on No Read** is useful when the imager needs to stay in sequence even if no decode occurs.

When **Sequence on No Read** is **Enabled** and **Matchcode Type** is set to **Sequential**, the imager sequences the master symbol on every match or No Read. When disabled, it does not sequence on a No Read.

[-] Matchcode

Matchcode Type	Disabled
Sequential Matching	Increment
Match Start Position	0
Match Length	1
Wild Card	*
Sequence on No Read	Enabled*
Sequence on Mismatch	Disabled
Sequence Step	Enabled*
New Master Pin	Disabled

Consider the following decodes as an example of **Sequence on No Read Enabled**:

<i>Master Symbol</i>	<i>Decoded Symbol</i>	<i>Master Symbol after Decode</i>
001	001	002
002	002	003
003	No Read	004 (sequence on No Read)
004	004	005
005	No Read	006 (sequence on No Read)
006	No Read	007 (sequence on No Read)
007	007	008

Consider the following decodes as an example of **Sequence on No Read Disabled**:

<i>Master Symbol</i>	<i>Decoded Symbol</i>	<i>Master Symbol after Decode</i>
001	001	002
002	002	003
003	No Read	003 (not sequenced)
003	003	004
004	No Read	004 (not sequenced)
004	No Read	004 (not sequenced)
004	004	005

## Sequence on Mismatch

**Note:** **Matchcode Type** must be set to **Sequential** for this command to function.

Enable this parameter if every trigger event should have a decode *and* more than one consecutive mismatch may occur. When set to Enabled, the master symbol sequences on every decode, match, or mismatch.

Disable this parameter if every trigger event should have a decode but no more than one consecutive mismatch may occur. When set to Disabled, the master symbol will not sequence whenever consecutive mismatches occur.

The imager will sequence the master to one more or one less than the decoded symbol.

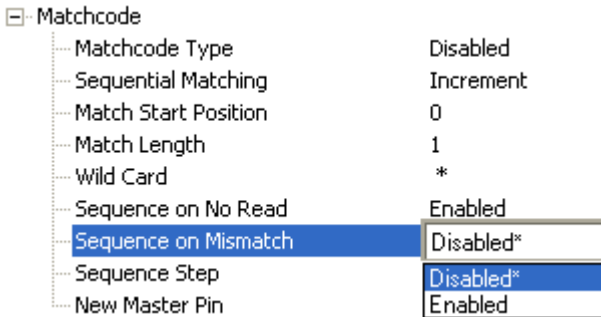

Consider the following decodes as an example of **Sequence on Mismatch Enabled**:

<i>Master Symbol</i>	<i>Decoded Symbol</i>	<i>Master Symbol after Decode</i>
001	001	002
002	002	003
003	abc	004 (sequence on mismatch)
004	004	005
005	def	006 (sequence on mismatch)
006	ghi	007 (sequence on mismatch)
007	007	008

Consider the following decodes as an example of **Sequence on Mismatch Disabled**:

<i>Master Symbol</i>	<i>Decoded Symbol</i>	<i>Master Symbol after Decode</i>
001	001	002
002	002	003
003	abc	004 (sequenced because of previous match)
004	004	005
005	def	006 (sequenced because of previous match)
006	ghi	006 (not sequenced)
006	006	007

## Sequence Step

When the master symbol is sequenced (incremented/decremented), **Sequence Step** defines the magnitude of change.

[-] Matchcode	
Matchcode Type	Disabled
Sequential Matching	Increment
Match Start Position	0
Match Length	1
Wild Card	*
Sequence on No Read	Enabled
Sequence on Mismatch	Disabled
Sequence Step	1 [1 - 32768]
New Master Pin	Disabled

## New Master Pin

If **Matchcode** and **New Master Pin** are enabled and the new master pin is momentarily connected to ground (must be held low for a minimum of 10 ms), master symbol information will be loaded into the database based on the next read cycle that achieves a Good Read, starting with **Index 1**. The **Master Database** will be loaded with all symbols decoded in the read cycle as long as it does not exceed the **Master Symbol Database Size** parameter.

[-] Matchcode	
Matchcode Type	Disabled
Sequential Matching	Increment
Match Start Position	0
Match Length	1
Wild Card	*
Sequence on No Read	Enabled
Sequence on Mismatch	Disabled
Sequence Step	1
New Master Pin	Disabled* Disabled* Enabled

## New Master Load Status

The new master status responds with the number of the next master position to be loaded, where 0 represents "idle" or "no master to be loaded."

*Example:* If the user has the **Master Symbol Database Size** set to 1, and then either sends a **<G>** or toggles an active **New Master Pin**, the state will be 1, and prior to reading and effectively loading position 1, the response to **<NEWM>** would be **<NEWM/1>**. Once a symbol has been read and loaded, the status will be cleared: **<NEWM/0>**.

## Match Replace

Provides a convenient shortcut for applications that need to output a predefined text string whenever a symbol matches a master symbol.

Outputs a user-defined data string whenever a match occurs and **Matchcode** is enabled.



## Replacement String

User-defined data string that, when enabled, replaces symbol data whenever a match occurs.

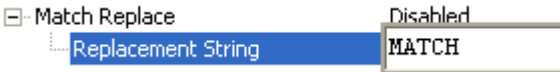

## Mismatch Replace

Provides a convenient shortcut for applications that need to output a predefined text string whenever a symbol does not match a master symbol.

Outputs a user-defined data string whenever a mismatch occurs and **Matchcode** is enabled.

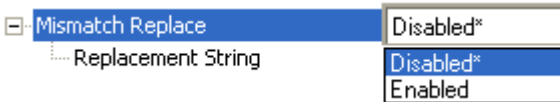

## Replacement String

User-defined data string that, when enabled, replaces symbol data whenever a mismatch occurs.

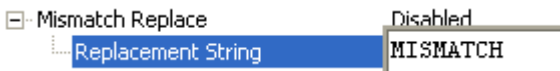

# Diagnostics

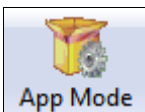

Click the **App Mode** button and then the **Parameters** button to display the tree control tabs.  
Then click the **Diagnostics** tab to display the Diagnostics tree control.

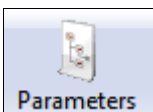

Parameters	ESP Values
[-] Diagnostics	
[-] Hours Since Reset (Read-only)	
Hours	0
Minutes	0
[-] Service Message	
Status	Disabled*
Service Message	Disabled*
Threshold	Enabled
Resolution	Seconds
User-Defined Name	QX HAWK

The \* indicates that the setting is the default.

To open nested options, **single-click** the +.

To change a setting, **double-click** the setting and use the cursor to scroll through the options.

**Note:** Matchcode settings can also be sent to the imager from ESP's Terminal using Microscan's K command format. Refer to the [8 | U bcghVg](#) section of [Appendix E](#).

## **Hours Since Reset (Read-only)**

Used as a troubleshooting tool that can help pinpoint the cause of a reset.

Records the number of hours and minutes of operation since the last system reset.

☐ Hours Since Reset (Read-only)

Hours	0
Minutes	0

### **Hours**

16-bit counter that increments every 60 minutes.

Range: 0 to 23 hours.

### **Minutes**

16-bit counter that increments every 60 seconds.

Range: 0 to 59 minutes.

## Service Message

### Status

When Enabled, a **Service Message** of up to 128 characters is sent whenever the system detects that the service time has expired.

[-] Service Message	
Status	Disabled*
Service Message	Disabled*
Threshold	Enabled
Resolution	Seconds

### Service Message

Allows the user to define a service message of up to 128 characters.

[-] Service Message	
Status	Disabled
Service Message	SERVICE
Threshold	300
Resolution	Seconds

### Threshold

Allows the user to determine the length of time until the service message will be sent.

[-] Service Message	
Status	Disabled
Service Message	SERVICE
Threshold	300 (1 - 65535)
Resolution	Seconds

### Resolution

The service timer has a resolution field for setting up the timer increment. Options are increments of seconds or minutes.

[-] Service Message	
Status	Disabled
Service Message	SERVICE
Threshold	300
Resolution	Seconds*
	Seconds*
	Minutes

## ***User-Defined Name***

**User-Defined Name** allows the user to enter any combination of ASCII characters to identify the imager.

User-Defined Name	Q	X	H	A	W	K
-------------------	---	---	---	---	---	---



# 6 Terminal

## Contents

- Terminal View..... 6-2
- Find ..... 6-3
- Send ..... 6-4
- Macros..... 6-5
- Terminal Menu..... 6-6

This section describes the multiple functions of ESP's **Terminal** interface.



# Terminal View

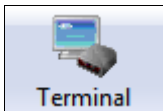

Click this button to display the **Terminal** view.

The screenshot shows the Terminal window interface with several callout boxes:

- Copy, paste, save**: Points to the top toolbar icons.
- Clear screen**: Points to the 'Send' button in the toolbar.
- Type text here to find matching text in the Terminal window.**: Points to the search field in the toolbar.
- Terminal screen**: Points to the main blue terminal area.
- Type serial commands here.**: Points to the main blue terminal area.
- Macros listed on this bar**: Points to the macro list at the bottom of the terminal area.
- Click on Macros arrow to Add Macro, Remove Macro, or Edit Macro.**: Points to the macro list at the bottom of the terminal area.
- Click on desired Macro to run.**: Points to a macro in the list at the bottom of the terminal area.

The **Terminal** interface allows the user to send serial commands to the imager by using macros, by copying and pasting, or by typing commands in the **Send** text field.

The Terminal also displays symbol data or information from the imager.

Right-clicking on the Terminal screen displays a menu of additional options.

# Find

The **Find** function allows the user to enter text strings to be searched for in the Terminal.

For example:

1. Type “ABC” into the **Find** box.



2. Press **Enter**.  
The first instance of “ABC” will be highlighted in the Terminal window.
3. Click the **Find** button to the left of the text field to locate additional instances of “ABC”.

## Send

The **Send** function allows the user to enter serial commands and then send them to the imager.

1. Type the command into the **Send** box.

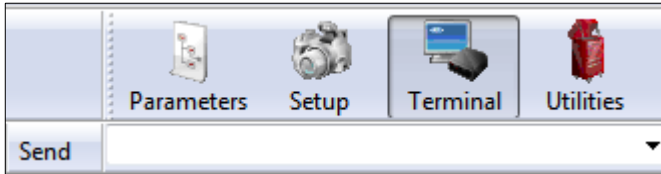

2. Press **Enter**.
3. Click the **Send** button to the left of the text field to send the command additional times.

## Macros

Macros can be stored in a macro selection bar, edited in a separate window, and executed by clicking on the macro name.

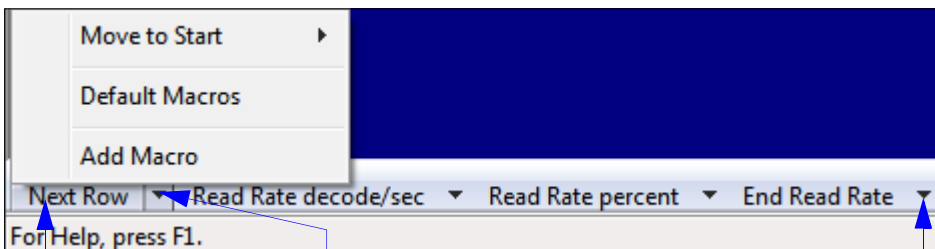

Click on **Next Row** to see the next row of macros

Click on the first arrow here to see **Add Macro** or **Default Macros**.  
When macros are defaulted, the entire macro set is restored to the original macro commands.

Click on subsequent arrows to edit macros.

Click a macro button to execute it in the Terminal.

If the macro is a command, it is sent to the imager at the same time that it is displayed.

## Editing a Macro

Click the arrow next to any macro and select **Edit** to display the following dialog:

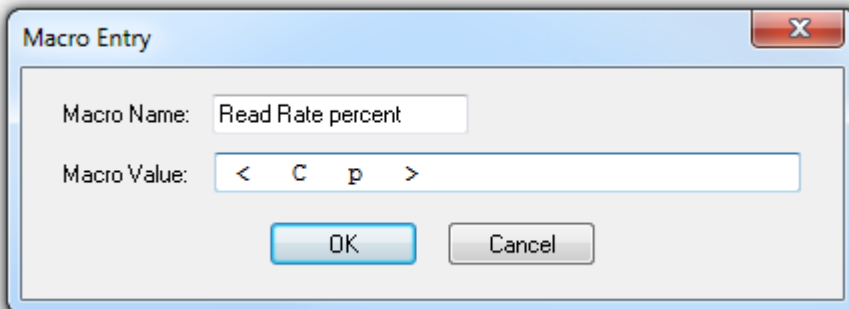

Edit the macro value or type a new **Macro Name** in the text field provided and define it in the **Macro Value** field. Click **OK** to save the entry.

# Terminal Menu

Right-click on the **Terminal** window to display the following menu:



- **Copy** selected text to clipboard.
- **Paste** from Terminal or other text.
- **Clear** all text in Terminal window.
- **Select All** text in the Terminal window.
- **Save...** brings up a **Save As** dialog.
- **Change Font...** of text in Terminal; brings up a **Font** dialog.
- **Change Echo Font...** to change typed text; brings up a **Font** dialog.
- **Enable Echo** enables Echo text (typed by user).
- **Change Background Color** of Terminal window.
- **Non-Printable Characters** allows the user to hide non-printable characters, or to show them in **Standard** or **Enhanced** format.
- **Default Settings** returns all the above settings to default.
- **Keyboard Macros** allows the user to create new keyboard macro commands that can be sent from function keys (F2, F4, F5, etc.)

## Terminal Dropdown Menu

The dropdown **Terminal** menu has **Capture Text**, **Save Current Text**, **Send File**, **Find Next**, and **Find Previous** functions, as well as the same functions defined above.

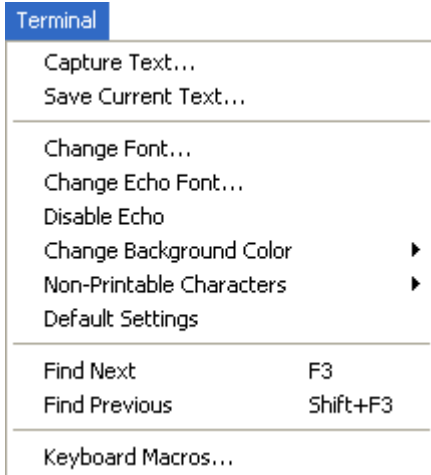

- **Capture Text...** allows the user to append data in real time to a text file. While in operation, the text file cannot be opened. Pause interrupts the capture flow and Stop ends the flow and opens the file.
- **Save Current Text...** saves all text in the Terminal window to a text file.
- **Find Next** searches for a user-defined section of text in the Terminal.
- **Find Previous** operates in the same way as Find Next, but searches backward through Terminal text.

# 7 Utilities

## Contents

Serial Utility Commands .....	7-2
Read Rate .....	7-4
Counters .....	7-6
Device Control .....	7-9
Differences from Default .....	7-10
Master Database .....	7-11
Firmware .....	7-17
Bar Code Configuration Mode .....	7-21
Calibration .....	7-22
Default/Reset/Save .....	7-23
Imager Status .....	7-25
Learn Operations .....	7-27
Reboot System .....	7-28
Static Validation .....	7-29
Targeting .....	7-31
Y-Modem Transfer Options .....	7-32
Temperature .....	7-34

This section explains the function and purpose of serial utility commands, which are generally performed during imager operation.



# Serial Utility Commands

Note: For a list of all K commands, see [Serial Commands](#).

Type	Command	Name
Bar Code Configuration	<BCCFG>	Enter Bar Code Configuration
Calibration	<@CAL>	Enter Auto Calibration
	<@OPTIC>	Initiate Lens Calibration (Standard QX Hawk only)
Counters	<N>	No Read Counter
	<O>	No Read Counter Reset
	<T>	Trigger Counter
	<U>	Trigger Counter Reset
	<V>	Good Read/Match Counter
	<W>	Good Read/Match Counter Reset
	<X>	Mismatch Counter
Default/Reset/Save	<Y>	Mismatch Counter Reset
	<A>	Software Reset – Retain Current Parameters
	<Ard>	Software Reset – Recall Factory Defaults
	<Arp>	Software Reset – Recall Power-On Defaults
	<Arc>	Software Reset – Recall Customer Defaults
	<Z>	Software Reset – Save Current Settings for Power-On
	<Zc>	Software Reset – Save Current Settings as Customer Defaults
	<Zrd>	Software Reset – Recall Factory Defaults and Save for Power-On
Device Control	<Zrc>	Software Reset – Recall Customer Defaults and Save for Power-On
	<L1>	Output 1 Pulse
	<L2>	Output 2 Pulse
	<L3>	Output 3 Pulse
	<I>	End Current Read Cycle
Firmware/Checksum	<H>	Enable Read Cycle
	<#>	Display All Firmware Part Numbers
	<#a>	Display Application Firmware Part Number
	<#b>	Display Boot Firmware Part Number
	<#d>	Display DSP Firmware Part Number
	<#k>	Display Kernel Firmware Part Number
	<#p>	Display System Configuration File Part Number
	<#s>	Display SafeMode Firmware Part Number
	<#.>	Display All Firmware Build Numbers
	<#a.>	Display Application Firmware Build Number
	<#b.>	Display Boot Firmware Build Number
<#d.>	Display DSP Firmware Build Number	



<b>Firmware/Checksum</b>	<#k.>	Display Kernel Firmware Build Number
	<#p.>	Display System Configuration File Build Number
	<!>	Display All Available Firmware Checksums
	<!a>	Display Application Firmware Checksum
	<!d>	Display DSP Firmware Checksum
<b>Imager Status</b>	<!p>	Display System Configuration File Checksum
	<?>	Imager Status Request
	<K?>	All Status Request
	<K??>	All Descriptor Request
	<K?#>	All Range Request
	<Knnn?>	Single Status Request
	<Knnn??>	Single Descriptor Request
	<Knnn?#>	Single Range Request
<b>Learn</b>	<Knnnd>	Single Command Default
	<LEARN>	Initiate Learn Operation
	<UNLEARN>	Initiate Unlearn Operation
<b>Master Database</b>	<LEARN?>	Display Learn Status
	<G>	Store Next Decoded Symbol to Database Index 1
	<Gn>	Store Next Decoded Symbol to Database Index <i>n</i>
<b>PDF Information</b>	<NEWM>	New Master Load Status
	<a1>	Enable/Disable PDF Information
<b>Read Rate</b>	<C>	Perform Decodes/Second Test
	<Cp>	Perform Decode Percent Test
	<J>	Exit Decodes/Second and Decode Percent Tests
<b>Reboot System</b>	<reboot>	Cold Boot System from Boot Code
<b>Static Validation</b>	<VAL>	Perform Static Validation of Data Matrix Symbol
<b>Targeting</b>	<I1>	Activate Targeting System (Standard QX Hawk only)
	<I0>	De-activate Targeting System (Standard QX Hawk only)
<b>Temperature</b>	<@TEMP>	Display Current Image Sensor Temperature
<b>Y-Modem Transfer</b>	<uy,path and image file name>	Y-Modem Upload
	<dy,key>	Y-Modem Download (Code)

# Read Rate



Click the **Utilities** button and then the **Read Rate** tab to display the Read Rate view.

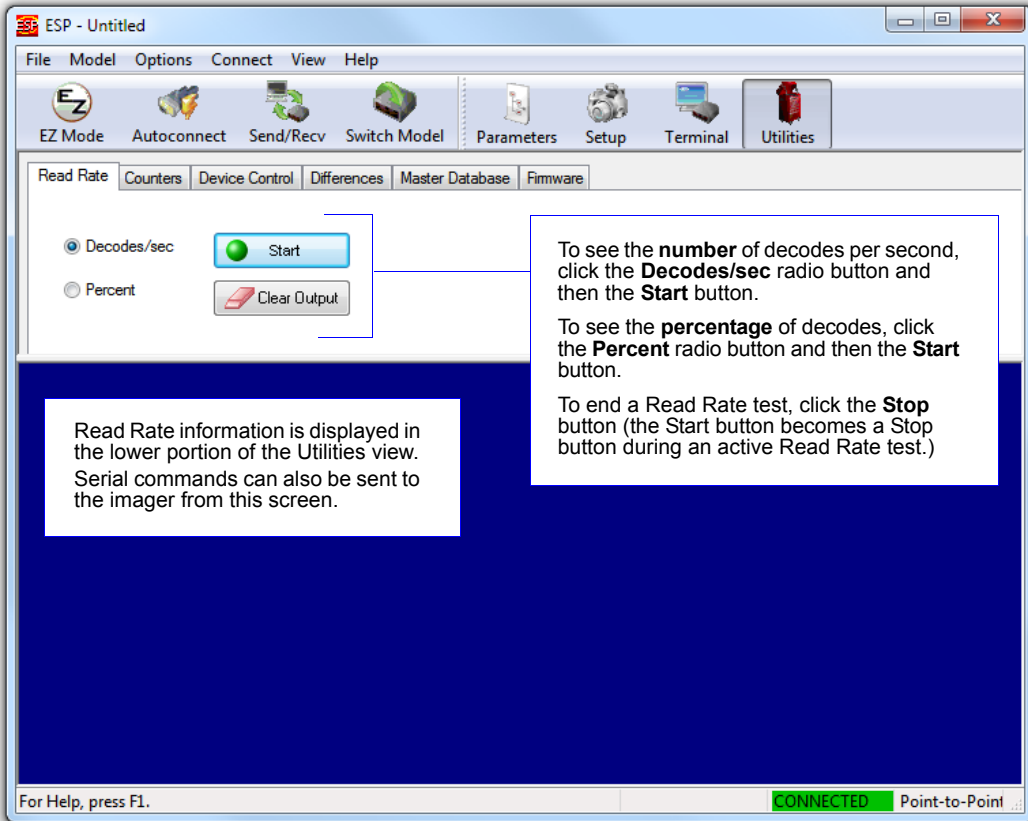

Read Rate information is displayed in the lower portion of the Utilities view. Serial commands can also be sent to the imager from this screen.

To see the **number** of decodes per second, click the **Decodes/sec** radio button and then the **Start** button.

To see the **percentage** of decodes, click the **Percent** radio button and then the **Start** button.

To end a Read Rate test, click the **Stop** button (the Start button becomes a Stop button during an active Read Rate test.)

**Important:** When Read Rate is enabled, the **Configuration Database** is not active, regardless of how the imager is configured.

## **Read Rate Serial Utility Commands**

### **Perform Decodes / Second Test**

Sending **<C>** instructs the imager to transmit the decodes per second and symbol data (if any). The decode rate can vary dramatically due to the angle and location of the symbol in relation to the field of view. This test is very useful in aligning and positioning the imager during setup.

### **Perform Decode Percent Test**

Sending **<Cp>** instructs the imager to transmit the percentage of decodes and any decoded symbol data.

### **Exit Decodes / Second and Decode Percent Tests**

Sending **<J>** ends both the Percent test and the Decodes/Second test.

# Counters

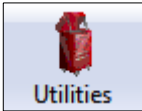

Click the **Utilities** button and then the **Counters** tab to display the Counters view.

**Counter** commands can be a numeric value from **00000** to **65535**. After reaching the maximum numeric limit of 65535, an error message will be displayed and the counter will automatically roll over and start counting again at 00000. To obtain the cumulative total of counts after the rollover has occurred, add 65536 per each rollover (the imager does not keep track of the number of rollovers) to the current count.

**Note:** All counter values will be lost if power is cycled, or if the imager receives a **Reset** or **Save** command.

Click the **Request** button to display the appropriate count or **Clear** to set the counter to zero.

The screenshot shows a software interface with a tabbed menu at the top containing: Read Rate, Counters (selected), Device Control, Differences, Master Database, and Firmware. Below the tabs are two large buttons: "Request All" and "Clear All". Underneath are four rows of controls, each with a "Request" button, a "Clear" button, and a text input field. The rows are labeled: "Trigger:", "Good Read:", "No Read:", and "Mismatch:". A callout box on the right side of the interface contains the following text: "Trigger, Good Read, No Read, and Mismatch counters can be requested and cleared simultaneously (**Request All** and **Clear All** buttons) or individually (**Request** and **Clear** buttons to the left of each item)."

## Counters Serial Utility Commands

### No Read Counter

Sending **<N>** displays the total number of no reads that have occurred since power-on or the last No Read Counter Reset command. A **<N/OVERF\_nnn>** will be output if the counter is overflowed (**nnn** represents the number of times it has been overflowed; 255 times is the maximum). Sending **<N>** again will return the amount by which the counter has been overflowed.

*Example:* If the counter is at **99999999** and **3** additional counts have been captured, then **<N/ERROR>** will be output and the next **<N>** command without any new no reads will return **<N/000000003>**.

### No Read Counter Reset

Sending **<O>** sets the No Read Counter to **00000000**.

### Trigger Counter

Sending **<T>** displays the total number of triggers that have occurred since power-on or the last Trigger Counter Reset command. A **<T/OVERF\_nnn>** will be output if the counter is overflowed (**nnn** represents the number of times it has been overflowed; 255 times is the maximum). Sending **<T>** again will return the amount by which the counter has been overflowed.

*Example:* If the counter is at **99999998** and **3** additional counts have been captured, then **<T/ERROR>** will be output and the next **<T>** command without any new triggers will return **<T/000000002>**.

### Trigger Counter Reset

Sending **<U>** sets the Trigger Counter to **00000000**.

### Good Read / Match Counter

Sending **<V>** displays either (1) the total number of decodes that match the master symbol or (2) the total number of good reads. The count begins from the last power-on or Good Read / Match Counter Reset command. To count the good reads that match the master symbol, enable Matchcode. To count good reads only, disable Matchcode. This counter is always active and can be requested at any time. A **<V/OVERF\_nnn>** will be output if the counter is overflowed (**nnn** represents the number of times it has been overflowed; 255 times is the maximum). Sending **<V>** again will return the amount by which the counter has been overflowed.

*Example:* If the counter is at **99999997** and **3** additional counts have been captured, then **<V/ERROR>** will be output and the next **<V>** command without any new good reads or matches will return **<V/000000001>**.

### Good Read / Match Counter Reset

Sending **<W>** sets the Good Read / Match Counter to **00000000**.

## Mismatch Counter

Sending **<X>** displays the total number of symbols successfully decoded that do not match the master symbol since power-on or the last Mismatch Counter Reset command. A **<X/OVERF\_nnn>** will be output if the counter is overflowed (**nnn** represents the number of times it has been overflowed; 255 times is the maximum). Sending **<X>** again will return the amount by which the counter has been overflowed.

*Example:* If the counter is at **99999999** and **1** additional count has been captured, then **<X/ERROR>** will be output and the next **<X>** command without any new mismatches will return **<X/00000001>**.

## Mismatch Counter Reset

Sending **<Y>** sets the Mismatch Counter to **00000000**.

# Device Control



Click the **Utilities** button and then the **Device Control** tab to display the Device Control view.

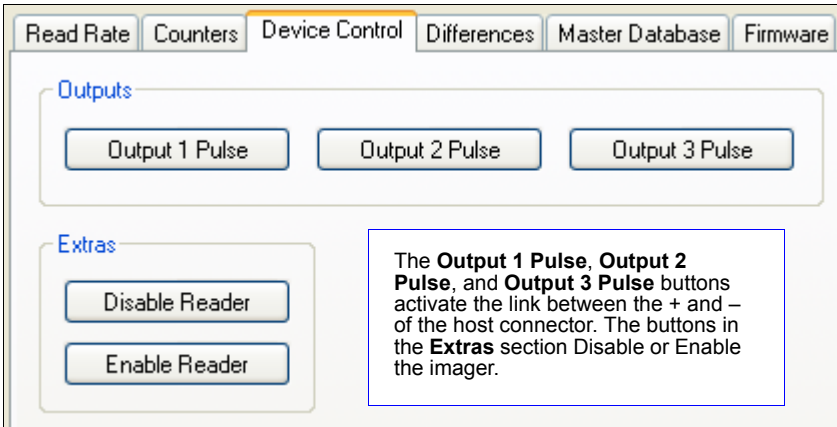

## Device Control Serial Utility Commands

### Output 1 Pulse

Sending **<L1>** activates the link between Output 1 (+) and Output 1 (-) of the host connector (regardless of Master Symbol or Output 1 status).

### Output 2 Pulse

Sending **<L2>** activates the link between Output 2 (+) and Output 2 (-) of the host connector (regardless of Master Symbol or Output 2 status).

### Output 3 Pulse

Sending **<L3>** activates the link between Output 3 (+) and Output 3 (-) of the host connector (regardless of Master Symbol or Output 3 status).

### End Current Read Cycle

Sending **<I>** will turn the imager OFF, end the current read cycle, and will not allow the imager to enter another read cycle until turned ON. This feature is useful during extended periods of time when no symbols are being decoded, or the imager is being configured. Disabling the imager will not affect any commands that have already been downloaded.

### Enable Read Cycle

Sending **<H>** will turn the imager ON and allow it to enter read cycles.

# Differences from Default



Click the **Utilities** button and then the **Differences** tab to display the Differences from Default view.

Clicking the **Differences from Default** button will cause **ESP** to check all stored configuration settings and compare them to default settings. All settings that are different than default will appear in the left column (shown below), and descriptions of those settings will appear in the right column.

Click this button for a list of **ESP** configuration settings that are different than default settings.

Click **Generate Barcode** to display the **Bar Code Dialog**. Then create configuration symbols containing the required configuration commands.

Command	Description
<K200,3>	Mode (External Edge)
<K220,,50>	Read Cycle Timeout (50)
<K474h,2>	Code 128 (Edge to Edge)
<K810,3>	Output On (No Read)
<K811,1>	Output On (Good Read/Match)
<K812,2>	Output On (Mismatch)

Send configuration settings to the imager without saving by clicking **Send to Reader**.

Click **Save As** to save the report as plain text or a tab-delimited text file.

Send configuration settings to the imager and save in ESP by clicking **Send and Save**.

- To create a symbol containing any of the command settings in the table, click **Generate Barcode**.
- To save the **Differences from Default** report, either as plain text or as a tab-delimited text file, click **Save As**.
- Click **Send and Save** to send the settings to the imager and save them, or **Send to Reader** to send the settings without saving them.

**Important:** To use **Differences from Default**, connect to the imager and **Receive Reader Settings** via the **Send/Recv** button on the toolbar.



# Master Database



Click the **Utilities** button and then the **Master Database** tab to display the Master Database view.

**Important:** The **Master Database** is used for all **Matchcode** modes except **Sequential** and **Wild Card**, both of which use **Master Database Index # 1**.

## Master Database Overview

Used where more than one master symbol is required, as in a **Multisymbol** setup, for matching and other **Matchcode** operations.

Allows the user to define up to 10 master symbols as the master symbol database, which can be entered by keyboard, scanned in, displayed, or deleted by serial or **ESP** commands.

1. Click the **Master Database** tab.
2. Enable **Matchcode Type**.
3. Set the **Master Symbol Database Size**.
4. Select the database index in which the master symbol will be entered.
5. Do one of the following to enter master symbol data:
  - a. Double-click the index row to type data directly into the index.
  - b. Click the **Read Symbol into Selected Index** to enter the next decoded symbol.

Set **Master Symbol Database Size** here.

Loads the next symbol decoded into the selected index.

The screenshot shows the 'Master Database' tab in a software interface. At the top, there are tabs for 'Read Rate', 'Counters', 'Device Control', 'Differences', 'Master Database', and 'Firmware'. Below the tabs, there are several controls: a 'Master Symbol Database Size' dropdown set to '5', a checked 'Matchcode Type' checkbox, and buttons for 'Read Symbol into Selected Index', 'Receive Reader's Database', and 'Send Database to Reader'. A table with 5 rows and 2 columns is visible, with the first column labeled 'Index' and the second 'Master Symbol Data'. The rows are numbered 1 to 5 and labeled 'Master Symbol 1' through 'Master Symbol 5'. Below the table is a text box with the instruction 'Double-click a row to enter data into popup text box.' At the bottom, there is a 'Caution' note about character limits.

Index	Master Symbol Data
1	Master Symbol 1
2	Master Symbol 2
3	Master Symbol 3
4	Master Symbol 4
5	Master Symbol 5

Caution: Since the total number of characters available for the master symbol database is limited, changes to the Master Symbol Database Size will re-allocate the number of characters available for each master symbol and could cause existing master symbols to be deleted. See manual for details.

Saves the database to the imager.

Loads the imager's saved master symbols into **ESP**.

Double-click a row to enter data into popup text box.

## Master Symbol Database Size

**Master Symbol Database Size** allows the user to select 1 to 10 master symbols for the master symbol database.

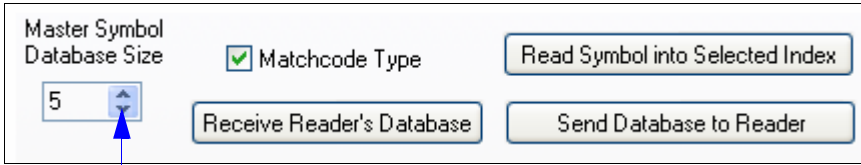

Set **Master Symbol Database Size** here.

**Important:** Since the total number of characters available for the master symbol database is **3000**, changes to the **Master Symbol Database Size** will re-allocate the number of characters available for each master symbol and could cause existing master symbols to be deleted (except master symbol # 1, unless it also exceeds the size limitation).

The table below specifies the maximum number of characters available to each symbol according to the number of master symbols defined, from 1 to 10.

<b>Master Symbol Number</b>	<b>Maximum Characters</b>
# 1	3000
# 2	1500
# 3	1000
# 4	750
# 5	600
# 6	500
# 7	428
# 8	375
# 9	333
# 10	300

## Enter Master Symbol Data

Allows the user to enter master symbol data for any enabled master symbol index number (1 to 10), provided the total number of characters does not exceed the maximum allowed.

Enter data for **1 to 10** master symbols.

**Caution:** If no data is entered, the existing data will be deleted.

1. Open the **Utilities** menu.
2. Set the number of master symbols to be created in **Master Symbol Database Size**.
3. Double-click on each master symbol number in the table, type master symbol data in the popup dialog that appears, and click **OK**.
4. When all master symbol data has been entered, click the **Send Database to the Reader** button.

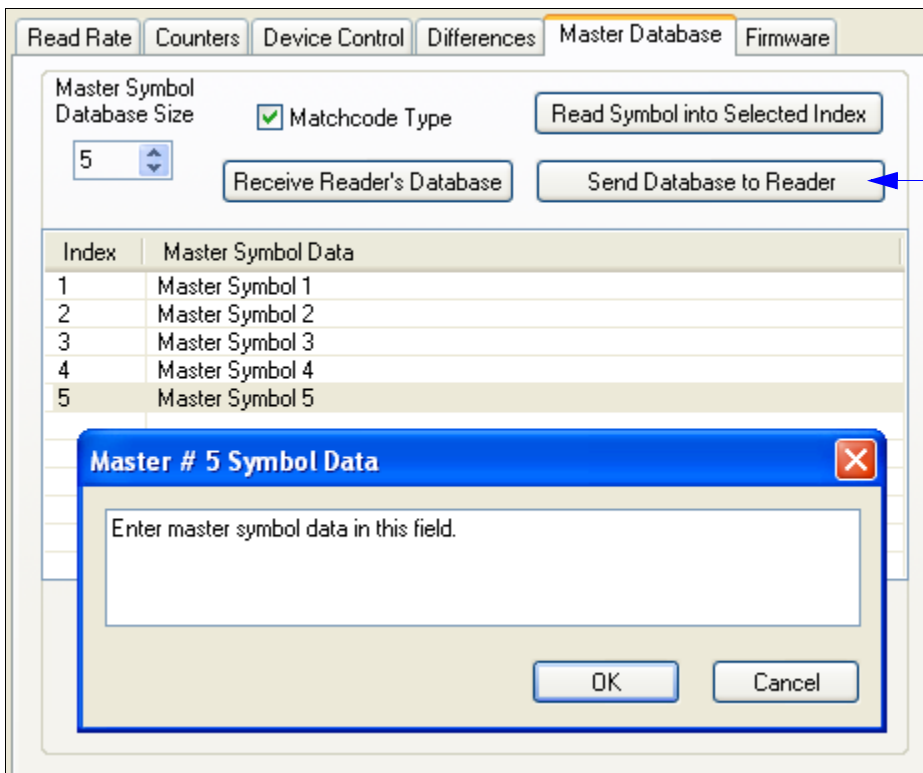

## Request Master Symbol Data

Returns master symbol data for any enabled master symbols from 1 to 10.

1. Click the **Utilities** button and the **Master Database** tab.
2. Click the **Receive Reader's Database** button.

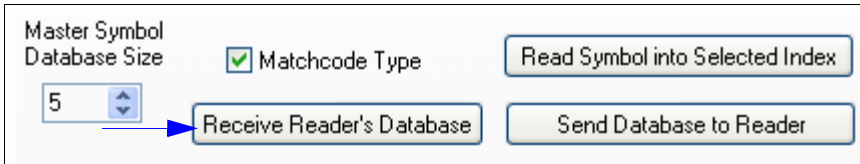

## Store Next Decoded Symbol to Database Index 1

After the size of the database is set, the imager can read the next symbol as the master symbol for any given master symbol number.

**<Gmaster symbol number>**

To store the next symbol decoded as master symbol # 1, send:

**<G>**.

## Store Next Decoded Symbol to Database Index n

To store the next symbol decoded as the master symbol for any other master symbol database number, send:

**<Gmaster symbol number [1-10]>**.

For example, **<G5>** will cause the next symbol read to be entered as master symbol # 5.

In the **Master Database** tab,

1. Select the master symbol index number in which new symbol data will be stored.
2. Click the **Read Symbol into Selected Index** button.

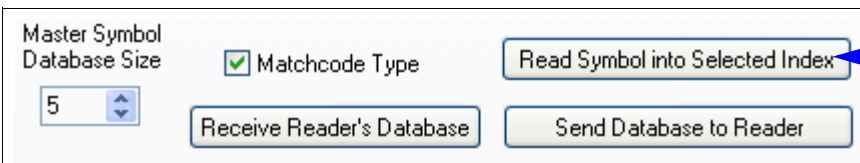

**Caution:** If an index with existing data is selected, that data will be overwritten by the new decoded data when this command is used.

## ***New Master Load Status***

Informs the user when a new master symbol is pending and which position it is in.

Returns the position in the master symbol database that will be loaded on the next read.

Send the **<NEWM>** command from ESP's Terminal.

The imager returns: **<NEWM/next master to load>**

Once a symbol has been read and loaded, the status will be cleared and the response will be **<NEWM/0>**.

## Delete Master Symbol Data

Master symbol data can be deleted using **ESP**.

1. Click the **Utilities** button to access the master symbol.
2. Click the **Master Database** tab and double-click the symbol number to be deleted.
3. Delete text and click **OK**.

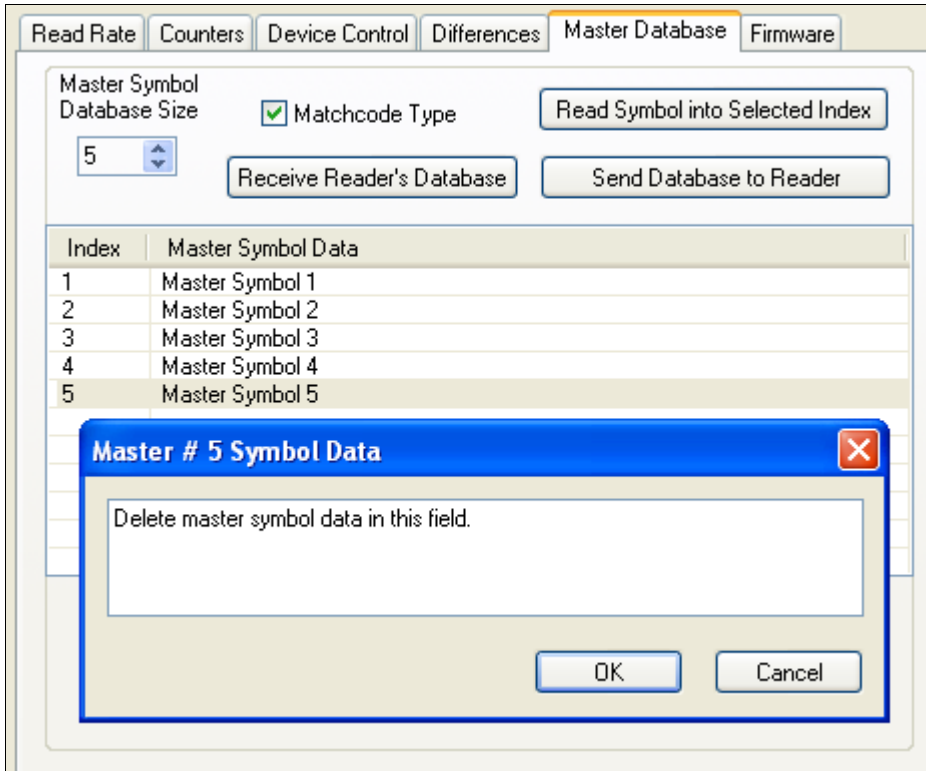

# Firmware



Click the **Utilities** button and then the **Firmware** tab to display the Firmware view.

## Firmware Update

**Firmware Update** is used to download application code to the imager. Application code versions are specific to the imager. Consult with a sales representative before downloading application code. If needed, application code can be requested from Microscan.

### To download application code:

1. First, be sure that the imager is connected to the host computer.
2. Apply power to the imager.
3. In the **Firmware Update** dropdown menu, select **App Code**. This will open a dialog that allows the user to browse for the application code file.
4. Navigate to where the application code file is located on the host computer.
5. Allow approximately a minute for firmware to download.

As the application code begins to download, the imager will be silent, the LEDs will flash intermittently, and a progress indicator at the bottom of the ESP window will show when the download is complete.

**Caution:** Do not interrupt power or disconnect the host cable while download is in progress.

## Firmware Verification

### Request Part Number

Send a request to the imager for application code, boot code, DSP code, or kernel code part numbers.

1. Click the **Firmware** tab.
2. Select App Code, Boot Code, DSP Code, or Kernel Code from the dropdown menu to the left of the **Request Part No.** button.
3. Click the **Request Part No.** button to see the part number displayed in the text field to the right.

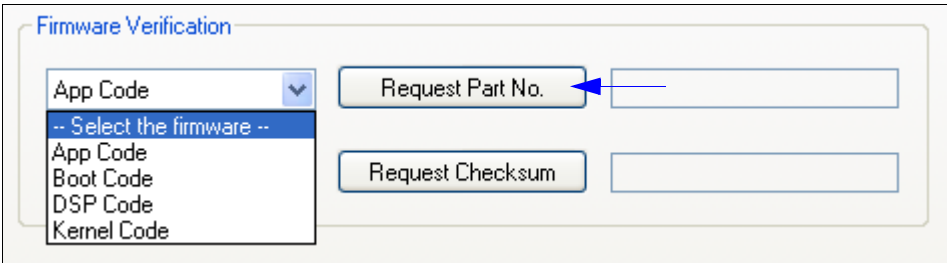

### Request Part Number by Serial Command

**Note:** X = base part number; R = revision number

- When **<#>** (Display All Firmware Part Numbers) is sent, the imager returns:  
**<#a/35-XXXXXX-RR><#b/35-XXXXXX-RR><#d/35-XXXXXX-RR><#k/35-XXXXXX-RR>  
<#p/Sys\_Cfg\_P/N><#s/SafeMode\_P/N>**.
- When **<#a>** (Display Application Firmware Part Number) is sent, the imager returns:  
**<#a/35-XXXXXX-RR>**.
- When **<#b>** (Display Boot Firmware Part Number) is sent, the imager returns:  
**<#b/35-XXXXXX-RR>**.
- When **<#d>** (Display DSP Firmware Part Number) is sent, the imager returns:  
**<#d/35-XXXXXX-RR>**.
- When **<#k>** (Display Kernel Firmware Part Number) is sent, the imager returns:  
**<#k/35-XXXXXX-RR>**.
- When **<#p>** (Display System Configuration File Part Number) is sent, the imager returns:  
**<#p/Sys\_Cfg\_P/N>**.
- When **<#s>** (Display SafeMode Firmware Part Number) is sent, the imager returns:  
**<#s/SafeMode\_P/N>**.



## Request Checksum

Send a request to the imager for application code or DSP code checksums.

1. Click the **Firmware** tab.
2. Select App Code or DSP Code from the dropdown menu to the left of the **Request Checksum** button.
3. Click the **Request Checksum** button to see the part number displayed in the text field to the right.

The screenshot shows a web interface titled "Firmware Verification". It contains two rows of controls. The top row has a dropdown menu labeled "App Code" with a downward arrow, followed by a button labeled "Request Part No." and an empty text input field. The bottom row has a dropdown menu labeled "App Code" with a downward arrow, followed by a button labeled "Request Checksum" and an empty text input field. A blue arrow points from the "Request Checksum" button to the text input field. The dropdown menu for the second "App Code" is open, showing three options: "-- Select the firmware --", "App Code", and "DSP Code".

## Request Checksum by Serial Command

- When **<!>** (Display All Available Firmware Checksums) is sent, the imager returns: **<!a/APP\_CHECKSUM><!d/DSP\_CHECKSUM><!d/CFG\_CHECKSUM>**.
- When **<!a>** (Display Application Firmware Checksum) is sent, the imager returns: **<!a/APP\_CHECKSUM>**.
- When **<!d>** (Display DSP Firmware Checksum) is sent, the imager returns: **<!d/DSP\_CHECKSUM>**.
- When **<!p>** (Display System Configuration File Checksum) is sent, the imager returns: **<!d/CFG\_CHECKSUM>**.

## Request Build Number by Serial Command

**Note:** **X** = base part number; **R** = revision number; **B** = build number

- When **<#.>** (**Display All Firmware Build Numbers**) is sent, the imager returns:  
**<#a/35-XXXXXX-RR.BBB><#b/35-XXXXXX-RR.BBB><#d/35-XXXXXX-RR.BBB>  
<#k/35-XXXXXX-RR.BBB><#p/35-XXXXXX-RR.BBB>**.
- When **<#a.>** (**Display Application Firmware Build Number**) is sent, the imager returns:  
**<#a/35-XXXXXX-RR.BBB>**.
- When **<#b.>** (**Display Boot Firmware Build Number**) is sent, the imager returns:  
**<#b/35-XXXXXX-RR.BBB>**.
- When **<#d.>** (**Display DSP Firmware Build Number**) is sent, the imager returns:  
**<#d/35-XXXXXX-RR.BBB>**.
- When **<#k.>** (**Display Kernel Firmware Build Number**) is sent, the imager returns:  
**<#k/35-XXXXXX-RR.BBB>**.
- When **<#p.>** (**Display System Configuration File Build Number**) is sent, the imager returns:  
**<#p/35-XXXXXX-RR.BBB>**.

# Bar Code Configuration Mode

*Definition:* **Bar Code Configuration Mode** is a way of programming the imager by using ECC 200 Data Matrix symbols.

*Serial Cmd:* **<BCCFG>**

**Bar Code Configuration Mode** can be entered three different ways:

1. By forcing the imager into **Bar Code Configuration Mode** by serial command **<BCCFG>**.
2. By configuring one of the 4 EZ Button positions to **Bar Code Configuration Mode**.
3. By reading a Data Matrix symbol with a special code word used by ISO/IEC 16022 to signify imager programming. This can be either in a regular read cycle or during a read rate test. Reading this symbol in the calibration routine will have no effect.<sup>1</sup>

Once **Bar Code Configuration Mode** has been entered, the Data Matrix symbols can be thought of as serial data. You can configure the imager by printing labels in Microscan's serial command format. Commands are processed as if the data were streamed in through the serial port. The imager will acknowledge the symbol with a beep, green flash, and echo the serial data to the host. If the command causes the imager to produce more serial output, such as serial verification or counter requests, the data will be routed to the host port.

**Bar Code Configuration Mode** can be exited by any reset **<A>** or **<Z>** command as well as a **<J>** or a quick press and release of the EZ Button.

The command to exit **Bar Code Configuration Mode** can be included as part of the Data Matrix symbol. For example, try encoding **<K200,4><K220,1><J>** into a Data Matrix symbol. This configures the imager to enable **Serial Trigger Mode**, to program a new trigger to end the read cycle, and to exit **Bar Code Configuration Mode** with **<J>**.

To end all EZ Button functions, press the EZ Button once and quickly release.

---

1. In normal reading modes, it is required to read a special Data Matrix symbol with a special codeword used by ISO/IEC 16022 to signify imager programming.

# Calibration

Sending the **<@CAL>** command from ESP's Terminal initiates auto-calibration without entering the auto-calibration menu. The calibrated parameters are determined by the settings of the **Calibration Options** command.

## Lens Calibration

**Important:** The **<@OPTIC>** command should only be used when changing the lens module.

**Important:** **<@OPTIC>** is not supported by the QX Hawk C-Mount Imager.

Sending the **<@OPTIC>** command puts the imager into a setup mode for the purpose of improving the accuracy of the focal distance parameter (**<K525>**). The imager comes with a default focal curve based on unit averages. When this isn't close enough to obtain all distances, the **<@OPTIC>** command can be used to start a 2-point test to normalize the focal distance and improve accuracy. This should generally be done with lenses that were not originally shipped with the imager.

**Important:** **<K525>** is not supported by the QX Hawk C-Mount Imager.

The table below shows the setting and test requirements to improve distance parameter accuracy.

Lens Type and Command	Inside Test Requirements	Outside Test Requirements
<K525,,1> (.) UHD 15°	10 mil/0.25 mm Data Matrix @ 1.0"/25 mm	30 mil/0.75 mm Data Matrix @ 10"/254 mm
<K525,,2> (..) HD 30°	10 mil/0.25 mm Data Matrix @ 1.0"/25 mm	30 mil/0.75 mm Data Matrix @ 10"/254 mm
<K525,,3> (...) SD 45°	10 mil/0.25 mm Data Matrix @ 1.0"/25 mm	30 mil/0.75 mm Data Matrix @ 10"/254 mm
<K525,,4> (o) SD 12°	10 mil/0.25 mm Data Matrix @ 1.0"/25 mm	30 mil/0.75 mm Data Matrix @ 10"/254 mm

## Default/Reset/Save

Understanding and controlling the imager's active, saved, and default settings are critical to its successful operation.

	Function	Serial Cmd	ESP <sup>a</sup>
Resets (Not Saved for Power-On)	Reset (Will not save for power-on)	<A>	Save to Reader, Send No Save
	Reset and Recall Microscan Default Parameters	<Ard>	Send <Ard> from Terminal
	Reset and Recall Power-On Parameters	<Arp>	Send <Arp> from Terminal
	Reset and Recall Customer Default Parameters	<Arc>	Send <Arc> from Terminal
Saved for Power-On	Save Current Settings for Power-On	<Z>	Save to Reader, Send and Save
	Save Current Settings as Customer Default Parameters for Power-On	<Zc>	Save to Reader, Send and Save Customer Defaults for Power-On <sup>b</sup>
	Recall Microscan Default Settings and Save for Power-On (Will not default "sticky parameters")	<Zrd>	Send <Zrd> from Terminal
	Recall Customer Default Settings and Save for Power-On	<Zrc>	Send <Zrc> from Terminal (You can also press and hold the EZ Button while powering on the imager to send this command.)

a. When right-clicking in a tree control to select **Default Current Menu Settings** or **Default All ESP Settings**, it is important to note that only **ESP** settings are defaulted. To save these defaults to the imager itself, follow up with a **Save to Reader, Send and Save** command.

b. Only available in ESP if enabled in **Preferences (General tab)**, accessible from the **Options** dropdown menu.

### Resets

Resets ("**A**" commands) affect only the current settings (active memory) and are not saved for power-on.

### Saved for Power-on

Power-on parameters ("**Z**" commands) are saved to NOVRAM and recalled and loaded into current parameters when power is cycled to the imager or the <Arp> command is sent.

### Defaults

Defaults are Microscan firmware settings or saved customer settings that can be recalled, either by software or hardware reset.

## Customer Default Parameters

Customer default parameters (saved by **<Zc>**) are the same set of parameters as power-on parameters but are saved in a different, isolated section of NOVRAM. This allows a user essentially to create a back-up set of parameters that can be recalled in the event that the current parameters or power-on parameters have been accidentally changed or are no longer desired.

It is important to note that a hardware default (jumper the default pin to ground) does not affect customer default parameters. For example, a user that has inadvertently changed communication settings and saved them with a **<Z>** command, may not know the correct settings or have the capability to communicate within those settings. By first doing an EZ Button default to restore the known Microscan defaults, the user can then recall the previous customer-saved settings with an **<Arc>** or **<Zrc>** command.

### Restore Customer Defaults

Use the EZ Button to default the scanner by holding it down while applying power to the scanner (if this feature is enabled).

## Microscan Default Parameters

Microscan default parameters are contained in the firmware and cannot be changed.

### Software Defaults

Microscan default parameters can be recalled (loaded into current settings) with the **<Ard>** command or recalled and saved for power-on with the **<Zrd>** command.

### Hardware Default

If a software default and reset is not possible, it may be necessary to reset the imager by shorting (connecting) specific pins. This procedure has the same effect as the **<Zrd>** software command.

**Important:** For this reset to occur, this command must be executed within 60 seconds of a power-on or a reset.

1. Apply power to the imager.
2. Locate default pin and ground. Ensure that the correct pins are located, as connecting the wrong pins may cause serious damage to the imager.
3. Momentarily connect the wires (or pins) and listen for a series of short beeps that last approximately 3 seconds.
4. Within 3 seconds, disconnect and then re-connect the two wires again. A longer beep should be heard. If not, repeat the process above.

### Default on Power-On

Use the EZ Button to default the imager by holding it down while applying power to the imager (if this feature is enabled).

# Imager Status

## <?> Imager Status Request

The imager responds to a status request <?> with a two character hex value, such as <?/22>. To determine status:

1. Look up the binary conversion in the table below.

For example, the first hex **2** would be **0 0 1 0** in binary, as read from binary digits **3** through **0**; the second hex **2** is also **0 0 1 0** as read from binary digits **7** through **4**.

2. Next, enter your binary values from the table below in the “Binary” column next to the appropriate bit.

Bit	Binary	Imager Status
0	0	Command error detected
1	1	Command received
2	0	Communication error detected
3	0	Flash sector unprotect failure
4	0	Host/Aux port buffer overflow
5	1	Imager is in a read cycle

3. Under “Binary,” interpret **1s** as true and **0s** as not true. For example, bit 1 has a **1** in the “Binary” column, indicating “Command Received”. Bit 5 is also a **1**, indicating that the “Imager is in a read cycle”.

Hex Value	Binary Bit Digits			
	7	6	5	4
	3	2	1	0
0	0	0	0	0
1	0	0	0	1
2	0	0	1	0
3	0	0	1	1
4	0	1	0	0
5	0	1	0	1
6	0	1	1	0
7	0	1	1	1
8	1	0	0	0
9	1	0	0	1
A	1	0	1	0
B	1	0	1	1
C	1	1	0	0
D	1	1	0	1
E	1	1	1	0
F	1	1	1	1

## <K?> All Status Request

This is the fastest way to learn the imager’s current configuration. Sending this request will return the current settings of all commands, starting with the lowest K command value and ending with the highest K command value.

## <K??> All Descriptor Request

This request will return all current descriptors for every K command, starting with the lowest K command value and ending with the highest K command value.

## <K?#> All Range Request

This request will return the current settings of all commands within the user-defined range, starting with the lowest user-defined K command value and ending with the highest user-defined K command value.

### **<Knnn?> Single Status Request**

This request will return the value of the variables associated with the requested K command. The request of a single entry of a database command cannot exceed the number of database slots for the specific command.

### **<Knnn??> Single Descriptor Request**

This request returns the basic functional description of all fields in the requested K command.

### **<Knnn?#> Single Range Request**

This request will return the value range and storage type description of all fields in the requested K command.

### **<Knnnd> Single Command Default**

This request will default a single K command to original factory parameters.



---

# Learn Operations

## *Initiate Learn Operation*

Sending the **<LEARN>** command from ESP's Terminal will put the imager into a mode of operation that will cause it to "learn" the next Data Matrix symbol decoded. This mode of operation will remain active until either a Data Matrix symbol is decoded or the call is made to disable the mode and revert back to normal operation. Upon decoding a Data Matrix symbol, the image processing will save pertinent information regarding the target symbol to allow it to be processed more quickly and consistently.

The data collected by the Learn operation can be saved for a Power-On condition by sending the **<Z>** command.

## *Initiate Unlearn Operation*

Sending the **<UNLEARN>** command will cause the imager to discard any information acquired during a Learn operation.

The Unlearn state can be saved for a Power-On condition by sending the **<Z>** command.

## *Display Learn Status*

Sending the **<LEARN?>** request will return the current status of Learn operations.

Responses are sent in this format:

**<LEARN,0>** (Default; symbol has not been learned.)

**<LEARN,1>** (Learn operation in progress.)

**<LEARN,2>** (Symbol has been learned.)

## *Learn Persistence*

The learn state and parameters persist in the same way as ordinary parameters.

*Examples:*

- A QX Hawk in a **Learned** state has not been saved. Cycling power will remove any Learned state information and the imager will power-on in its configured state.
- A QX Hawk is saved in a **Learning** state. The imager will power-on in the Learning state and will learn the first Data Matrix symbol decoded.
- A QX Hawk is saved in a **Learned** state. The imager will power-on in the Learned state and will only decode the learned symbol type.
- A QX Hawk in a **Learned** state is issued a reset default command **<Ard>**. The unit will return to an **Unlearned** state but if power is cycled it will return to its saved state.

## **Reboot System**

Sending a **<reboot>** command from ESP's Terminal will "cold-reboot" the system, starting from Boot Code.

## Static Validation

Sending a **<VAL>** command from ESP's Terminal will cause the imager to perform a static validation operation on a Data Matrix symbol and will output validation results to the Terminal.

### Output Screen

Data Matrix validation information is output in the format below in response to the **<VAL>** command.

**Note:** If the imager fails to decode the Data Matrix symbol, a No Read message is displayed.

Validation Report						GRADE
ISO/IEC	Symbol Contrast	=	60 %			B
16022:	Print Growth	=	-0.53	Dx - 48 %	Dnom - 50 %	B
				Dy - 42 %	Dmax - 65 %	
				Dmin - 35 %		
	Axial Nonuniformity	=	0.02	Xavg - 4.7		A
	Unused ECC	=	34 %	Yavg - 4.6		
				Eact - 8		D
				Emax - 12		
GRADING:	% Cell Damage	=	2 %			
	Total Read Time	=	30 ms			
	Capture Time	=	17 ms			
	Locate Time	=	10 ms			
	Decode Time	=	3 ms			
	Pixels/Element	=	4.6			
	ECC Level	=	200			
	Matrix Size	=	16x16			
	Quiet Zone	=	PASS			
SYMBOL						
DATA:	CT9900000000001834214					

## Validation Parameters

### Symbol Contrast

**Usage:** Lets the user know if contrast settings are less than acceptable.

**Definition:** All the pixels that fall within the area of the test symbol, including its required zone, will be sorted by their reflectance values to select the darkest 10% and the lightest 10% of the pixels. The arithmetic mean of the darkest and the lightest pixels is calculated and the difference of the two means is the Symbol Contrast.

(ANSI) Symbol Contrast grading is defined this way:

- A (4.0) if SC ? 70%
- B (3.0) if SC ? 55%
- C (2.0) if SC ? 40%
- D (1.0) if SC ? 20%
- F (0.0) if SC ? 20%

## Print Growth

*Definition:* The extent to which dark or light markings appropriately fill or exceed their module boundaries. These values are determined by counting pixels in the clock pattern of the binary digitized image, then comparing it to a nominal value and minimum and maximum values. The grade is defined in this way:

- A (4.0) if  $-.050 \leq PG \leq 0.50$
- B (3.0) if  $-.070 \leq PG \leq 0.70$
- C (2.0) if  $-.085 \leq PG \leq 0.85$
- D (1.0) if  $-.100 \leq PG \leq 1.00$
- F (0.0) if  $PG < -1.00$  or  $PG > 1.00$

## Axial Non-Uniformity (Data Matrix Only)

*Definition:* Axial non-uniformity is a measure of how much the sampling point spacing differs from one axis to another, namely

$$AN = \text{abs}(XAVG - YAVG) / ((XAVG + YAVG)/2)$$

where  $\text{abs}(\ )$  yields the absolute value. If a symbology has more than two major axes, then AN is computed for those two average spacings which differ the most. The grade is defined in this way:

- A (4.0) if  $AN \leq .06$
- B (2.0) if  $AN \leq .08$
- C (2.0) if  $AN \leq .10$
- D (1.0) if  $AN \leq .12$
- F (0.0) if  $AN > .12$

## Unused Error Correction (Data Matrix Only)

*Definition:* The correction capacity of Reed-Solomon decoding is expressed in the equation:

$$e + 2d \leq d - p$$

where  $e$  is the number of erasures,  $t$  is the number of errors,  $d$  is the number of error correction codewords, and  $p$  is the number of codewords reserved for error detection.

The Unused Error Correction parameter tests the extent to which regional or spot damage in the symbol has eroded the decoding safety margin that error correction provides. The grade is defined in this way:

- A (4.0) if  $UEC \leq .62$
- B (3.0) if  $UEC \leq .50$
- C (2.0) if  $UEC \leq .37$
- D (1.0) if  $UEC \leq .25$
- F (0.0) if  $UEC > .25$

# Targeting

## ***Activate Targeting System***

Sending a **<l1>** command (lower-case L and numeral 1) from ESP's Terminal activates the imager's targeting system.

**Important:** **<l1>** is not supported by the QX Hawk C-Mount Imager.

## ***De-activate Targeting System***

Sending a **<l0>** command (lower-case L and numeral 0) de-activates the imager's targeting system.

**Important:** **<l0>** is not supported by the QX Hawk C-Mount Imager.

# Y-Modem Transfer Options

## Y-Modem Upload

<uy,path and image file name>

**Note:** There are only three scales available from the imager. The three scales are full, quarter, and eighth. The Directory response will read out the image dimensions. To receive the image, request to download by the reported dimensions. If quarter-scaled or eighth-scaled images are required, then divide the dimensions by 4 or by 8 and request by the reduced dimensions.

### (1.) Directory

(None assumes root)

/ (Root Directory)

/saved (Saved Directory)

### (2.) Image Status

Good/ (IP decoded a symbol)

No Read/ (IP did not decode a symbol)

Mismatch/ (IP decoded the wrong symbol)

Pending/ (Not run through IP)

### (3.) Age

0 to n

n = Max Images (8 ? Max)

### (4.) Image Name (Full-Scale)

1280 x 1024.bmp

1280 x 1024\_gs.bmp

1280 x 1024.jpg

1280 x 1024\_q(1-100).jpg

### Valid Scales (Depends on Full Dimensions)

1280 x 1024 (Full)

320 x 256 (Quarter - divide by 4)

160 x 128 (Eighth - divide by 8)

### (5.) Type

.bmp (Bitmap image - no loss of resolution)

.jpg (JPEG image - loss of resolution with compression)

### JPEG Compression Quality (1-100%)

\_q1.jpg

\_q100.jpg

**Examples:** <uy,/saved/noread/2/320x256\_gs.bmp> <uy,/saved/noread/2/320x256\_q33.jpg>

## ***Y-Modem Download (Code)***

<dy,key>

### **Key**

app.bin

dsp.bin

ker.bin

**Note:** The “key” field only accepts app.bin, dsp.bin, or ker.bin.

## Temperature

### ***Display Current Image Sensor Temperature***

Sending an **<@TEMP>** command from ESP's Terminal will cause the imager to respond with the current temperature of the image sensor in degrees C. The output from this command is only updated after an image frame has been captured. If the command is requested without capturing an image, the temperature value will not change.

*Example Response:*

**<TEMP/30.50c>**



# Appendices

## Contents

Appendix A General Specifications .....	A-2
Appendix B Electrical Specifications .....	A-11
Appendix C Ground and Shield Considerations .....	A-20
Appendix D Flying Lead Cordset Pinouts.....	A-22
Appendix E Serial Commands .....	A-23
Appendix F Protocol Commands.....	A-85
Appendix G ASCII Table .....	A-94
Appendix H Configuring Ethernet TCP/IP .....	A-95
Appendix I Using EtherNet/IP.....	A-98
Appendix J Allen-Bradley Version 16 PLC Setup.....	A-107
Appendix K Allen-Bradley Version 20 PLC Setup .....	A-120
Appendix L EIPScan Setup .....	A-132
Appendix M Interface Standards .....	A-138
Appendix N Glossary of Terms .....	A-139

# Appendix A — General Specifications

## Mechanical (Standard QX Hawk)

**Height:** 1.59" (40.5 mm)

**Width:** 2.27" (57.6 mm)

**Depth:** 3.79" (96.3 mm)

**Weight:** 10 oz. (280 g)

## Mechanical (QX Hawk C-Mount)

**Height:** 4.03" (102.3 mm)

**Width:** 2.27" (57.6 mm)

**Depth:** 1.59" (40.5 mm)

**Weight:** 11 oz. (320 g)

## Environmental

**Enclosure:** Die-cast aluminum, IP65/67 rated

**Operating Temperature:** CMOS: 0° to 50° C (32° to 122° F); CCD: 0° to 45° C (32° to 113° F)

**Storage Temperature:** -29° to 70° C (-20° to 158° F)

**Humidity:** up to 90% (non-condensing)

**Humidity:** up to 90% (non-condensing)

## Communication Interface

**Standard Interfaces:** RS-232/422/485, Ethernet

## CE Mark

**General Immunity for Light Industry:** EN

55024:1998 ITE Immunity Standard

**Radiated and Conducted Emissions of ITE Equipment:**

EN 55022:98 ITE Disturbances

## Light Source (Standard QX Hawk)

**Type:** High-output LEDs



## Symbologies

**2D Symbologies:** Data Matrix (ECC 0-200), QR Code,

Micro QR Code, Aztec Code

**Stacked Symbologies:** PDF417, MicroPDF417, GS1

DataBar (Composite and Stacked)

**Linear Symbologies:** Code 39, Code 128, BC412,

Interleaved 2 of 5, UCP/EAN, Codabar, Code 93,

Pharmacode, Postal Symbologies

## Light Collection Options

Progressive scan, square pixel

**Shutter:** Software-adjustable 1/60 to 1/100,000

(CMOS);

1/30 to 1/100,000 (CCD)

**WVGA CMOS:** 752 x 480 pixels

**SXGA CCD:** 1280 x 960 pixels

## Indicators

**LEDs:** Read performance, power, read status, network activity, I/O

**Beeper:** Good Read, Match/Mismatch, No Read, serial command confirmation, On/Off

**Green Flash (Standard QX Hawk):** Good Read

**Red X (Standard QX Hawk):** Symbol locator

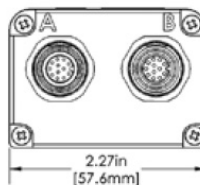
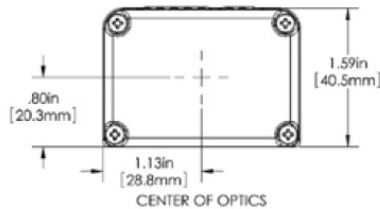
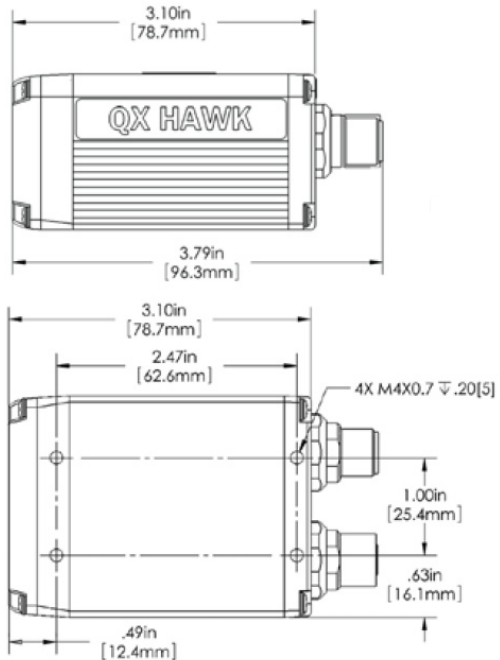

## QX Hawk Dimensions

**Note:** Nominal dimensions shown. Typical tolerances apply.

**Read Parameters**

**Pitch:**  $\pm 30^\circ$

**Skew:**  $\pm 30^\circ$

**Tilt:**  $\pm 360^\circ$

**CMOS Decode Rate:** Up to 60 decodes per second

**CCD Decode Rate:** Up to 20 decodes per second

**Laser Light (Standard QX Hawk)**

**Type:** Laser diode

**Output Wavelength:** 655 nm nominal

**Operating Life:** 50,000 hours @ 25° C

**Safety Class:** Visible laser: Class 1

<b>CLASS 1 LASER PRODUCT</b>	Complies with 21 CFR 1040.10 and 1040.11 except for deviations pursuant to Laser Notice No. 50, dated June 24, 2007.
----------------------------------	--

**Protocols**

Point-to-Point, Point-to-Point with RTS/CTS, Point-to-Point with XON/XOFF, Point-to-Point with RTS/CTS and XON/XOFF, Multidrop, Daisy Chain, User-Defined Multidrop, Ethernet TCP/IP, EtherNet/IP

**Electrical**

**CMOS Power Requirement:** 5-28VDC, 200 mV p-p max ripple, 135 mA at 24VDC (typ.)

**CCD Power Requirement:** 5-28VDC, 200 mV p-p max ripple, 170 mA at 24VDC (typ.)

**Discrete I/O**

**Input 1/Trigger/New Master:** Bi-directional, Optoisolated, 4.5–28V rated (13 mA at 24VDC)

**Outputs (1, 2, 3):** Bi-directional, Optoisolated, 1–28V rated ( $I_{CE} < 100$  mA at 24VDC, current limited by user)

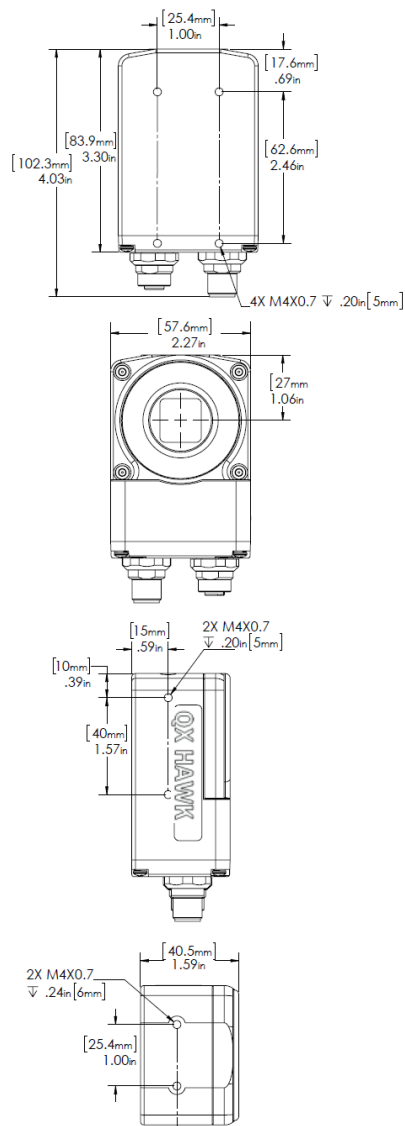

**QX Hawk C-Mount Dimensions**

**Note:** Nominal dimensions shown. Typical tolerances apply.

---

## General Specifications

### Safety Certifications

CDRH, FCC, UL/cUL (Listed, UL60950 4K68), CE, CB, BSMI (compliant)



### RoHS/WEEE Compliant



### U.S. Patents

7,118,042 | 7,341,190 | 8,146,823 | 8,154,810 | 7,213,761 | 7,311,260

©2017 Omron Microscan Systems, Inc.

All rights reserved. Specifications subject to change.

Read Range and other performance data is determined using high quality Grade A symbols per ISO/IEC 15415 and ISO/IEC 15416 in a 25° C environment. For application-specific Read Range results, testing should be performed with symbols used in the actual application. Omron Microscan Applications Engineering is available to assist with evaluations. Results may vary depending on symbol quality. Warranty—For current warranty information on this product, please visit [www.microscan.com/warranty](http://www.microscan.com/warranty).

## QX-1 Interface Device

### ***Mechanical***

**Height:** .75" (19.1 mm)

**Width:** 2.50" (83.5 mm)

**Depth:** 3.15" (80 mm)

**Weight:** 7 oz. (200 g)

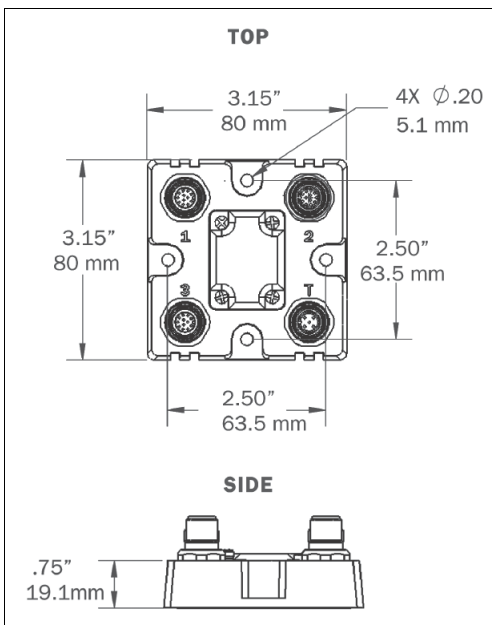

**QX-1 Dimensions**

General Specifications

## Read Ranges (Standard QX Hawk)

**Note:** Ranges correspond to specific symbol element sizes, and range increases as element size increases.

### CMOS Modular Zoom Optics: Inches (mm)

	Narrow Bar Width		Read Range (using autofocus)	Field of View		Depth of Field	
	1D	2D		Inside Edge	Outside Edge	Inside Edge	Outside Edge
12°	0.0033 (0.08)	0.005 (0.13)	3.4 to 6 (86 to 152)	0.9 (23)	1.42 (36)	0.2 (5)	0.4 (10)
	0.0075 (0.19)	0.010 (0.25)	3.3 to 12.2 (83 to 310)	0.9 (23)	2.62 (66)	0.4 (10)	1.5 (38)
	0.0150 (0.38)	0.020 (0.51)	3.3 to 13 (82 to 330)	0.9 (23)	2.77 (70)	0.5 (13)	3.5 (89)
	0.0350 (0.89)	0.050 (1.27)	4 to 16 (101 to 406)	1.03 (26)	3.34 (85)	0.7 (18)	6.5 (165)

	Narrow Bar Width		Read Range (using autofocus)	Field of View		Depth of Field	
	1D	2D		Inside Edge	Outside Edge	Inside Edge	Outside Edge
15°	0.0033 (0.08)	0.005 (0.13)	1.9 to 5 (48 to 127)	0.75 (19)	1.53 (39)	0.3 (6)	0.4 (10)
	0.0075 (0.19)	0.010 (0.25)	1.8 to 8 (46 to 203)	0.72 (18)	2.28 (58)	0.4 (10)	1 (25)
	0.0150 (0.38)	0.020 (0.51)	1.75 to 9 (44 to 229)	0.72 (18)	2.52 (64)	0.5 (13)	3 (76)
	0.0350 (0.89)	0.050 (1.27)	3 to 10.8 (76 to 274)	1.03 (26)	2.96 (75)	0.6 (15)	4 (101)

	Narrow Bar Width		Read Range (using autofocus)	Field of View		Depth of Field	
	1D	2D		Inside Edge	Outside Edge	Inside Edge	Outside Edge
30°	0.0033 (0.08)	0.005 (0.13)	1 to 3 (25 to 76)	0.83 (21)	1.8 (46)	0.4 (10)	0.8 (20)
	0.0075 (0.19)	0.010 (0.25)	1 to 6.5 (25 to 165)	0.83 (21)	3.5 (89)	0.8 (20)	1.8 (46)
	0.0150 (0.38)	0.020 (0.51)	1 to 16 (25 to 406)	0.83 (21)	8.3 (211)	2 (51)	8.5 (216)
	0.0350 (0.89)	0.050 (1.27)	2 to 32 (51 to 813)	1.3 (33)	16.4 (417)	3 (76)	21.5 (546)

	Narrow Bar Width		Read Range (using autofocus)	Field of View		Depth of Field	
	1D	2D		Inside Edge	Outside Edge	Inside Edge	Outside Edge
45°	0.0075 (0.19)	0.010 (0.25)	1 to 5 (25 to 127)	1.3 (33)	4.1 (104)	1.5 (38)	2 (51)
	0.015 (0.38)	0.020 (0.51)	1 to 9.5 (25 to 241)	1.3 (33)	7.5 (191)	2 (51)	6 (152)
	0.035 (0.89)	0.050 (1.27)	1 to 23.5 (25 to 597)	1.3 (33)	18.3 (465)	3.8 (97)	19 (483)

### CCD Modular Zoom Optics: Inches (mm)

	Narrow Bar Width		Read Range (using autofocus)	Field of View		Depth of Field	
	1D	2D		Inside Edge	Outside Edge	Inside Edge	Outside Edge
	12°	0.002 (0.05)		0.0033 (0.08)	3.5 to 7 (87 to 178)	0.9 (23)	1.62 (41)
0.005 (0.13)		0.0075 (0.19)	3.4 to 12 (86 to 304)	0.9 (23)	2.62 (66)	0.2 (5)	1 (25)
0.010 (0.25)		0.0150 (0.38)	3.3 to 13 (83 to 330)	0.9 (23)	2.77 (70)	0.4 (10)	2.5 (64)
0.020 (0.51)		0.0300 (0.76)	4 to 14 (101 to 355)	1.03 (26)	2.96 (75)	0.6 (15)	5 (127)

	Narrow Bar Width		Read Range (using autofocus)	Field of View		Depth of Field	
	1D	2D		Inside Edge	Outside Edge	Inside Edge	Outside Edge
	15°	0.002 (0.05)		0.0033 (0.08)	2 to 5 (51 to 127)	0.78 (20)	1.53 (39)
0.005 (0.13)		0.0075 (0.19)	1.9 to 8.3 (48 to 210)	0.75 (19)	2.35 (60)	0.3 (8)	1 (25)
0.010 (0.25)		0.0150 (0.38)	1.9 to 9.5 (47 to 241)	0.75 (19)	2.65 (67)	0.5 (13)	3 (76)
0.020 (0.51)		0.0300 (0.76)	3 to 10.3 (76 to 261)	1.03 (26)	2.84 (72)	0.6 (15)	4.5 (114)

	Narrow Bar Width		Read Range (using autofocus)	Field of View		Depth of Field	
	1D	2D		Inside Edge	Outside Edge	Inside Edge	Outside Edge
	30°	0.002 (0.05)		0.0033 (0.08)	1 to 3 (25 to 76)	0.83 (21)	1.8 (46)
0.005 (0.13)		0.0075 (0.19)	1 to 6.5 (25 to 165)	0.83 (21)	3.5 (89)	0.8 (20)	1.8 (46)
0.010 (0.25)		0.0150 (0.38)	1 to 16 (25 to 406)	0.83 (21)	8.3 (211)	2 (51)	8.5 (216)
0.020 (0.51)		0.0300 (0.76)	2 to 32 (51 to 813)	1.3 (33)	16.4 (417)	3 (76)	21.5 (546)

	Narrow Bar Width		Read Range (using autofocus)	Field of View		Depth of Field	
	1D	2D		Inside Edge	Outside Edge	Inside Edge	Outside Edge
	45°	0.005 (0.13)		0.0075 (0.19)	1 to 5 (25 to 127)	1.3 (33)	4.1 (104)
0.010 (0.25)		0.0150 (0.38)	1 to 9.5 (25 to 241)	1.3 (33)	7.5 (191)	2 (51)	6 (152)
0.020 (0.51)		0.0300 (0.76)	1 to 23.5 (25 to 597)	1.3 (33)	18.3 (465)	3.8 (97)	19 (483)

## Read Ranges (cont.)

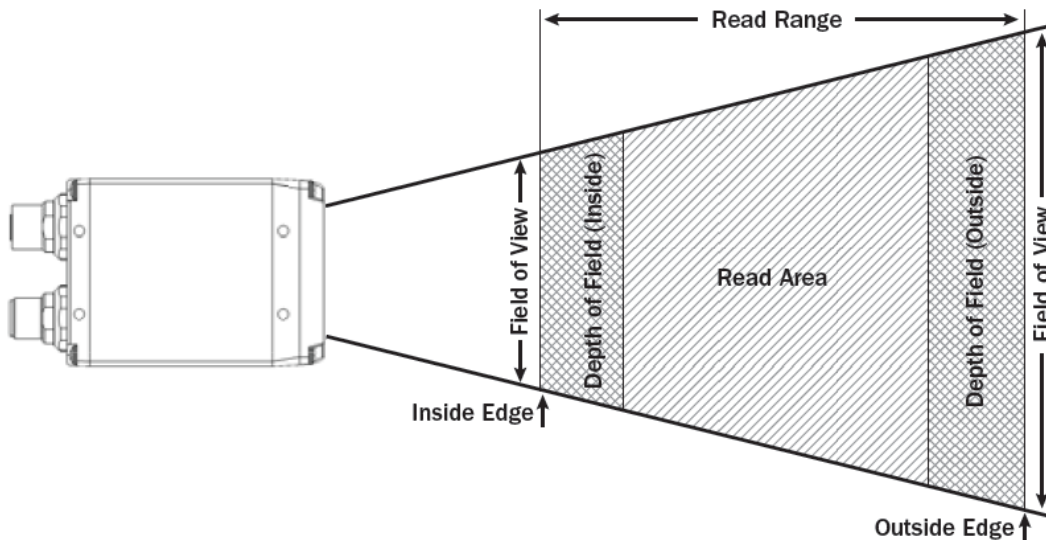

## FIS Options

FIS-6801-0000G	QX Hawk, Industrial Imager, C-Mount Optic, Serial, CCD, SXGA
FIS-6801-0010G	QX Hawk, Industrial Imager, C-Mount Optic, Serial, CMOS, WVGA
FIS-6801-0500G	QX Hawk, Industrial Imager, 15 Degree Optic, Serial, CCD, SXGA
FIS-6801-0510G	QX Hawk, Industrial Imager, 15 Degree Optic, Serial, CMOS, WVGA
FIS-6801-0200G	QX Hawk, Industrial Imager, 30 Degree Optic, Serial, CCD, SXGA
FIS-6801-0210G	QX Hawk, Industrial Imager, 30 Degree Optic, Serial, CMOS, WVGA
FIS-6801-0300G	QX Hawk, Industrial Imager, 45 Degree Optic, Serial, CCD, SXGA
FIS-6801-0310G	QX Hawk, Industrial Imager, 45 Degree Optic, Serial, CMOS, WVGA
FIS-6801-0400G	QX Hawk, Industrial Imager, 12 Degree Optic, Serial, CCD, SXGA
FIS-6801-0410G	QX Hawk, Industrial Imager, 12 Degree Optic, Serial, CMOS, WVGA
FIS-6801-1000G	QX Hawk, Industrial Imager, C-Mount Optic, Ethernet, CCD, SXGA
FIS-6801-1010G	QX Hawk, Industrial Imager, C-Mount Optic, Ethernet, CMOS, WVGA
FIS-6801-1500G	QX Hawk, Industrial Imager, 15 Degree Optic, Ethernet, CCD, SXGA
FIS-6801-1510G	QX Hawk, Industrial Imager, 15 Degree Optic, Ethernet, CMOS, WVGA
FIS-6801-1200G	QX Hawk, Industrial Imager, 30 Degree Optic, Ethernet, CCD, SXGA
FIS-6801-1210G	QX Hawk, Industrial Imager, 30 Degree Optic, Ethernet, CMOS, WVGA
FIS-6801-1300G	QX Hawk, Industrial Imager, 45 Degree Optic, Ethernet, CCD, SXGA
FIS-6801-1310G	QX Hawk, Industrial Imager, 45 Degree Optic, Ethernet, CMOS, WVGA
FIS-6801-1400G	QX Hawk, Industrial Imager, 12 Degree Optic, Ethernet, CCD, SXGA
FIS-6801-1410G	QX Hawk, Industrial Imager, 12 Degree Optic, Ethernet, CMOS, WVGA



## Accessories

<b>Power Supplies</b>	
97-000012-01	QX Power Supply, 100-240VAC, +24VDC, M12 12-pin Socket
97-000003-02	QX Power Supply, 24V M12 12-pin Plug, 1.3 m Cable, USA/Euro
<b>Cables, Communication Devices, Accessories</b>	
61-000148-02	QX Cordset, Common, M12 12-pin Socket (Screw-On) to M12 12-pin Plug (Screw-On), 3 m
61-000162-02	QX Cordset, Common, M12 12-pin Socket (Screw-On) to M12 12-pin Plug (Screw-On), 1 m
61-000153-02	QX Cordset, Host, Serial, M12 12-pin Socket (Screw-On) to DB9 Socket, 1 m
61-000164-02	QX Cordset, Host, Serial, M12 12-pin Socket (Screw-On) to DB9 Socket, 3 m
61-000152-02	QX Cordset, Host, Serial, M12 12-pin Plug (Screw-On) to DB9 Socket, 1 m
61-000165-02	QX Cordset, Host, Serial, M12 12-pin Plug (Screw-On) to DB9 Socket, 3 m
61-000163-01	QX Cordset, Host, Ethernet, M12 8-pin Plug (Ultra-Lock) to RJ45, 3 m
61-000163-02	QX Cordset, Host, Ethernet, M12 8-pin Plug (Screw-On) to RJ45, 3 m
61-000160-01	QX Cordset, Host, Ethernet, M12 8-pin Plug (Ultra-Lock) to RJ45, 1 m
61-000160-02	QX Cordset, Host, Ethernet, M12 8-pin Plug (Screw-On) to RJ45, 1 m
61-000158-03	QX Cordset, M12 12-pin Plug and M12 12-pin Socket to MS-Connect 210 (RS-232), 2 m
61-000158-04	QX Cordset, M12 12-pin Plug and M12 12-pin Socket to MS-Connect 210 (RS-422), 2 m
61-000166-02	QX Cordset, M12 12-pin Plug (Screw-On) to Flying Leads, 3 m
61-000167-02	QX Cordset, M12 12-pin Socket (Screw-On) to Flying Leads, 3 m
61-000207-01	QX Cordset, Smart Series Light to QX-1, Continuous ON/OFF
61-000204-01	QX Cordset, Smart Series Light to QX-1, Continuous Power
61-000218-01	QX Cordset, Smart Series Light to QX-1, Strobe, NPN
98-000103-02	QX-1 Interface Device
FIS-0210-0001G	MS-Connect 210, Connectivity Box with Display
FIS-0210-0002G	MS-Connect 210, Connectivity Box
FIS-0210-0003G	MS-Connect 210, Connectivity Box with Display and Ethernet
FIS-0210-0004G	MS-Connect 210, Connectivity Box with Ethernet
98-000143-01	Kit, Adapter Plate, QX Hawk
98-000144-01	Kit, Right Angle Mirror, QX Hawk
98-000146-01	Kit, Window Replacement, QX Hawk
98-000147-04	Kit, 12° Lens, QX Hawk
98-000147-01	Kit, 15° Lens, QX Hawk
98-000147-02	Kit, 30° Lens, QX Hawk
98-000147-03	Kit, 45° Lens, QX Hawk
98-000205-01	Kit, Glass Window with IR Coating, QX Hawk
98-000206-01	Kit, Glass Window, QX Hawk
98-000206-02	Kit, Lexan Window with Metal Bezel, QX Hawk
98-000149-01	Demo Kit, QX Hawk
98-000262-01	Kit, White LED Illumination, QX Hawk
98-000262-02	Kit, Blue LED Illumination, QX Hawk
98-000013-04	Relay Module, 120VAC, 3 Amp Output, Series 70, Type SM for MS-Connect 210
98-000013-05	Relay Module, 240VAC, 3 Amp Output, Series 70, Type SM for MS-Connect 210
98-000013-06	Relay Module, 24VDC, 3 Amp Output, Series 70, Type SM for MS-Connect 210
98-92800471	Lens Extension Tube, 5 mm (C-CS Mount Adapter)

## General Specifications

98-CO206	Lens Extension Tube Set 0.5, 1, 5, 10, 20, 40 mm
98-92800571	Lens 8mm F/1.4-16, Front Thread 25.5 mm P 0.5 mm, 2/3" C-Mount
98-000257-01	Lens 12.5mm F/1.4-close, Front Thread 40.5 mm P 0.5 mm, 1" C-Mount
98-000258-01	Lens 16mm F/1.4-16, Front Thread 27 mm P 0.5 mm, 2/3" C-Mount
98-000259-01	Lens 25mm F/1.4-16, Front Thread 27 mm P 0.5 mm, 2/3" C-Mount
98-92800575	Lens 35mm F/2.1-22, Front Thread 25.5 mm P 0.5 mm, 2/3" C-Mount
98-92800576	Lens 50mm F/2.8-22, Front Thread 25.5 mm P 0.5 mm, 2/3" C-Mount
98-92800577	Lens 75mm F/3.9-32, Front Thread 25.5 mm P 0.5 mm, 2/3" C-Mount
98-92800311	Lens, Skylight UV Filter, 25.5 mm
98-92800371	Lens, Polarizing Filter, 25.5 mm, P0.5
98-92800372	Lens, Polarizing Filter, 27 mm, P0.5
98-000218-01	Lens Protection Housing, Standard Length (up to 48 mm)
98-000226-01	Lens Protection Housing, Long (up to 72 mm)
20-610024-01	Trigger Connector, 4-pin Plug (Screw Terminal; Field-Wireable; Self-Wiring)
98-000037-01	Kit, Mounting Arm Extension, All Readers, 6 inch
98-000054-01	Kit, Mounting Stand Base Plate
98-000016-01	Kit, Mounting Arm/Adapter, QX Hawk, 6 inch
99-000056-01	Bracket, Smart Series DOAL 50 mm to QX Hawk
99-000058-01	Bracket, Smart Series DOAL 75 mm to QX Hawk
99-000060-01	Bracket, Smart Series DOAL 100 mm to QX Hawk
99-000061-01	Bracket, Smart Series DOAL 50 mm / 70 mm / 100 mm to C-Mount QX Hawk
99-000050-01	Bracket, Smart Series Ring 100 mm to QX Hawk
99-000052-01	Bracket, Smart Series Ring 60 mm / 70 mm to QX Hawk
99-000049-01	Bracket, Smart Series Ring 100 mm to C-Mount QX Hawk
99-000051-01	Bracket, Smart Series Ring 60 mm / 70 mm to C-Mount QX Hawk
98-000148-01	Kit, L-Bracket, QX Series
<b>Object Detectors</b>	
99-000020-01	QX Photo Sensor, M12 4-pin Plug, NPN, Dark Off, 2 m
99-000020-02	QX Photo Sensor, M12 4-pin Plug, NPN, Dark On, 2 m
<b>Documentation</b>	
37-000010-01	Microscan Tools Drive: Software, Documentation, Links to Microscan website

## Appendix B — Electrical Specifications

- **CMOS Power Requirement:** 5-28VDC, 200 mV p-p max ripple, 135 mA at 24VDC (typ.)
- **CCD Power Requirement:** 5-28VDC, 200 mV p-p max ripple, 170 mA at 24VDC (typ.)

### QX Hawk Connectors



**A** is a serial M12 12-pin plug. It is the same for all models of the QX Hawk.

**B** is a serial M12 12-pin socket for serial models and an Ethernet M12 8-pin socket for Ethernet models.

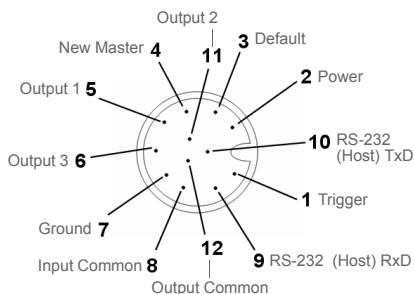

#### **A (All Models) M12 12-pin Plug**

Pin	Function	Wire Color
1	Trigger	White
2	Power	Brown
3	Default	Green
4	New Master	Yellow
5	Output 1	Gray
6	Output 3	Pink
7	Ground	Blue
8	Input Common	Red
9	RS-232 (Host) RxD	Black
10	RS-232 (Host) TxD	Violet
11	Output 2	Gray/Pink
12	Output Common	Red/Blue

Continued next page

## QX Hawk Connectors and Pinouts (continued)

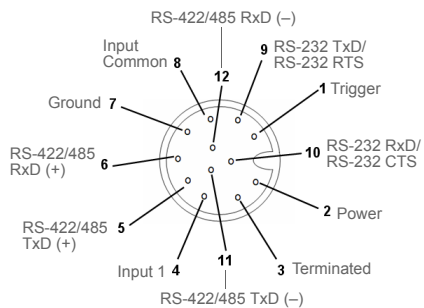

**B (Serial) M12 12-pin Socket**

Pin	Function	Wire Color
1	Trigger	White
2	Power	Brown
3	Terminated	Green
4	Input 1	Yellow
5	Port 3 422/485 TxD (+)	Gray
6	Port 3 422/485 RxD (+)	Pink
7	Ground	Blue
8	Input Common	Red
9	Port 2 TxD/Port 1 RTS	Black
10	Port 2 RxD/Port 1 CTS	Violet
11	Port 3 422/485 TxD (-)	Gray/Pink
12	Port 3 422/485 RxD (-)	Red/Blue

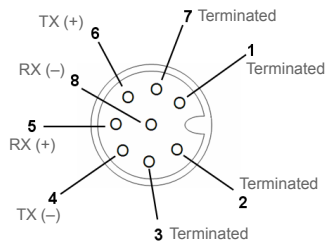

**B (Ethernet) M12 8-pin Socket**

Pin	Function
1	Terminated
2	Terminated
3	Terminated
4	TX (-)
5	RX (+)
6	TX (+)
7	Terminated
8	RX (-)

## QX-1 Connectors

**Connector T** on the QX-1 Interface Device is the Trigger connector.

**Connectors 1, 2, and 3** can be used to bus power and data as required by the application.

The connectors on the QX-1 interface device physically mirror those on the QX Hawk imager, but they do not have explicit pin assignments. The QX-1 connectors take on the communications and power roles that are assigned to them.

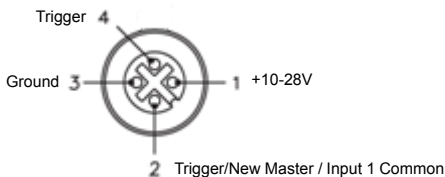

**QX-1 Trigger Connector  
4-pin Socket**

1	+10-28V
2	Trigger / New Master / Input 1 Common
3	Ground
4	Trigger

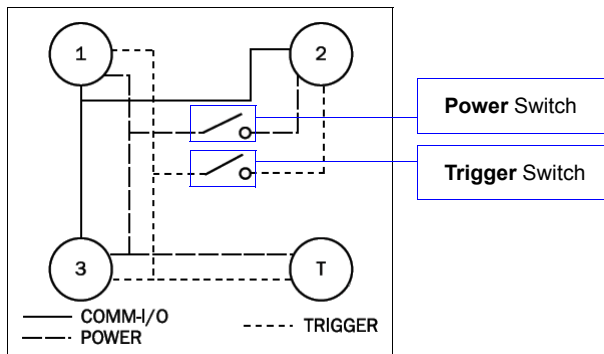

**QX-1 Wiring Diagram**

**Connectors 1 and 3** are 12-pin plugs, and **Connector 2** is a 12-pin socket. All three connectors can be assigned to bus power and data.

The two switches at the center of the device allow the user to route signals as needed.

The simple diagram above (also shown on the base of the QX-1) illustrates how power, communications, I/O, and trigger signal can be routed through the QX-1 device.

**Power** can be bussed between imagers and interface devices. At each location on a network where a new power supply is added, the Power switch on the QX-1 can be used to break power between Connector 2 and Connectors 1, 3, and T.

The **Trigger** signal between Connector 2 and Connectors 1, 3, and T can be broken using the Trigger switch. This isolates trigger signals as required.

## Optoisolated Outputs

The imager has optoisolated outputs that can transfer signals from the imager to peripherals. Outputs can be configured as either NPN or PNP, but NPN and PNP cannot be mixed in a system, because the output common is shared by all outputs.

### NPN Output for Host Input

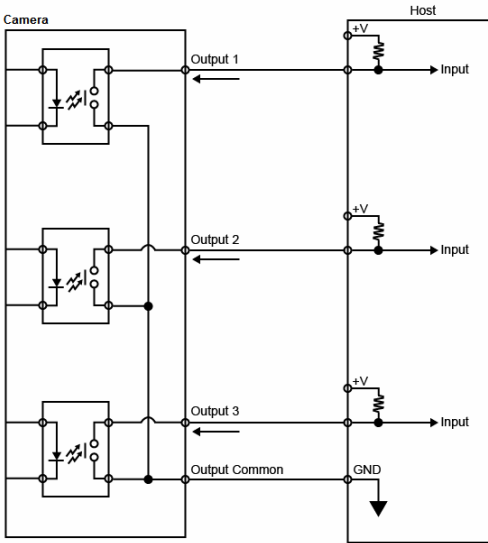

### NPN Output for External Load

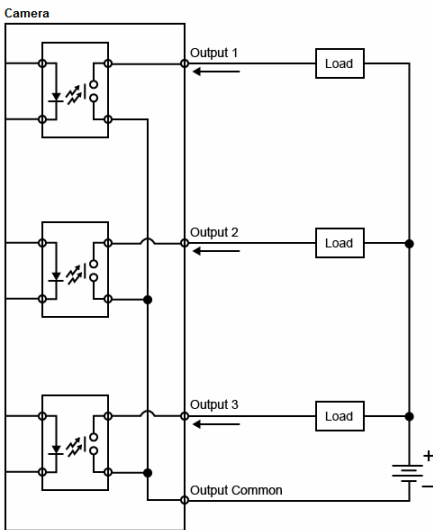

### PNP Output for Host Input

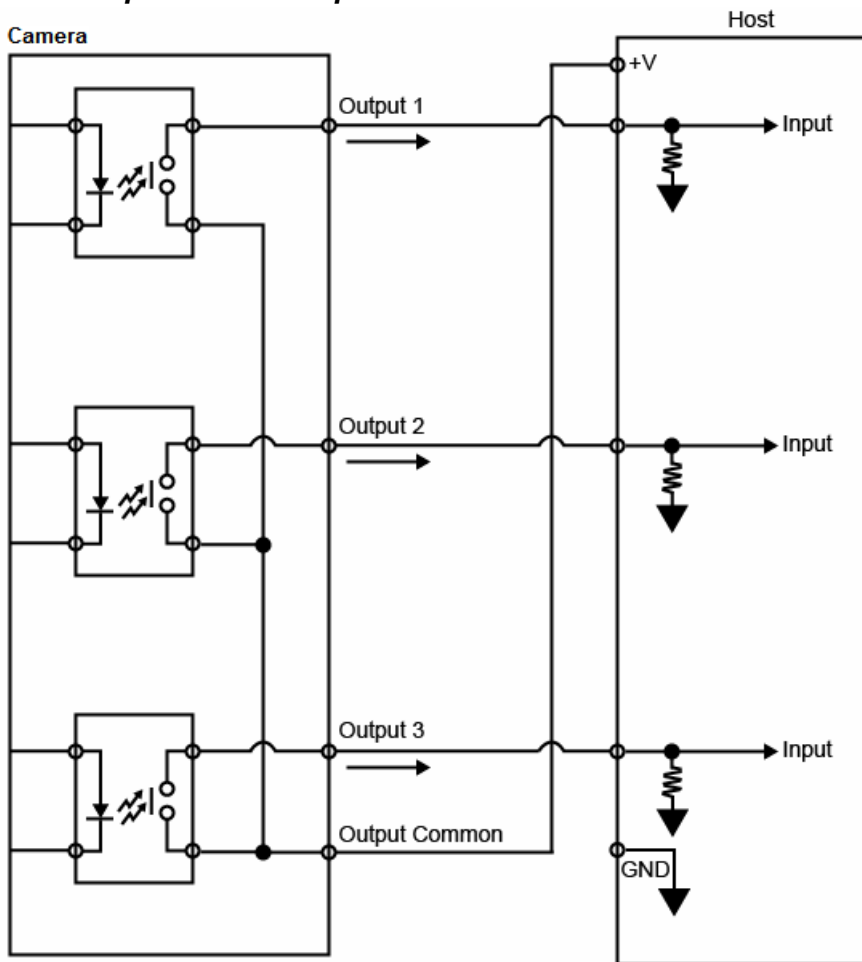

### PNP Output for External Load

Camera

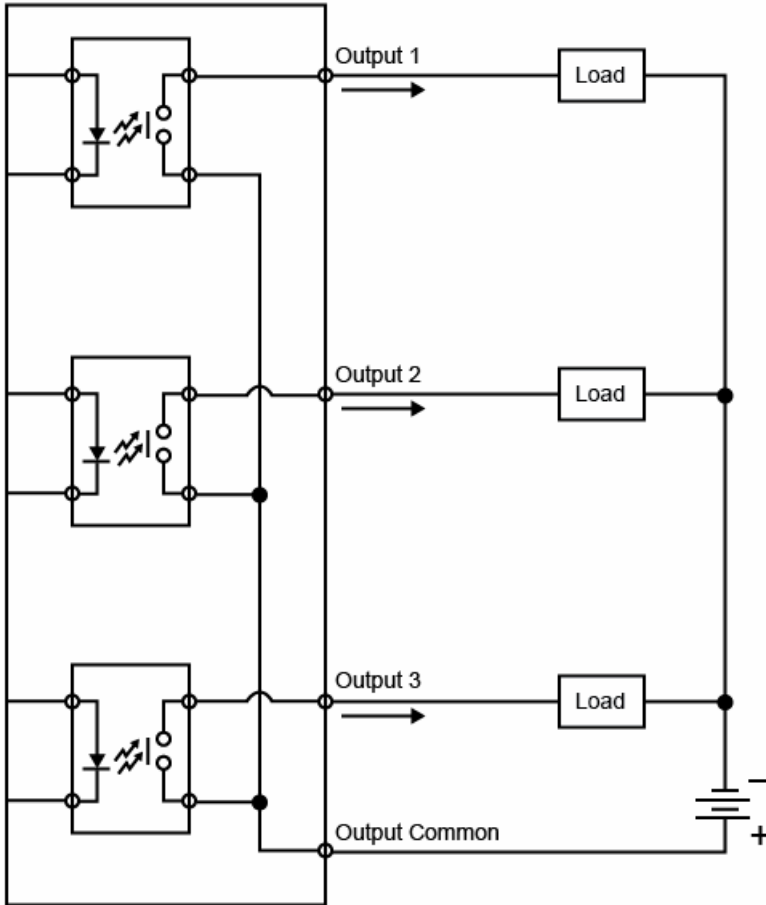



## Optoisolated Inputs

All discrete inputs are optoisolated. Inputs can be configured as either NPN or PNP, but NPN and PNP cannot be mixed in a system, because the input common is shared by all inputs.

### NPN

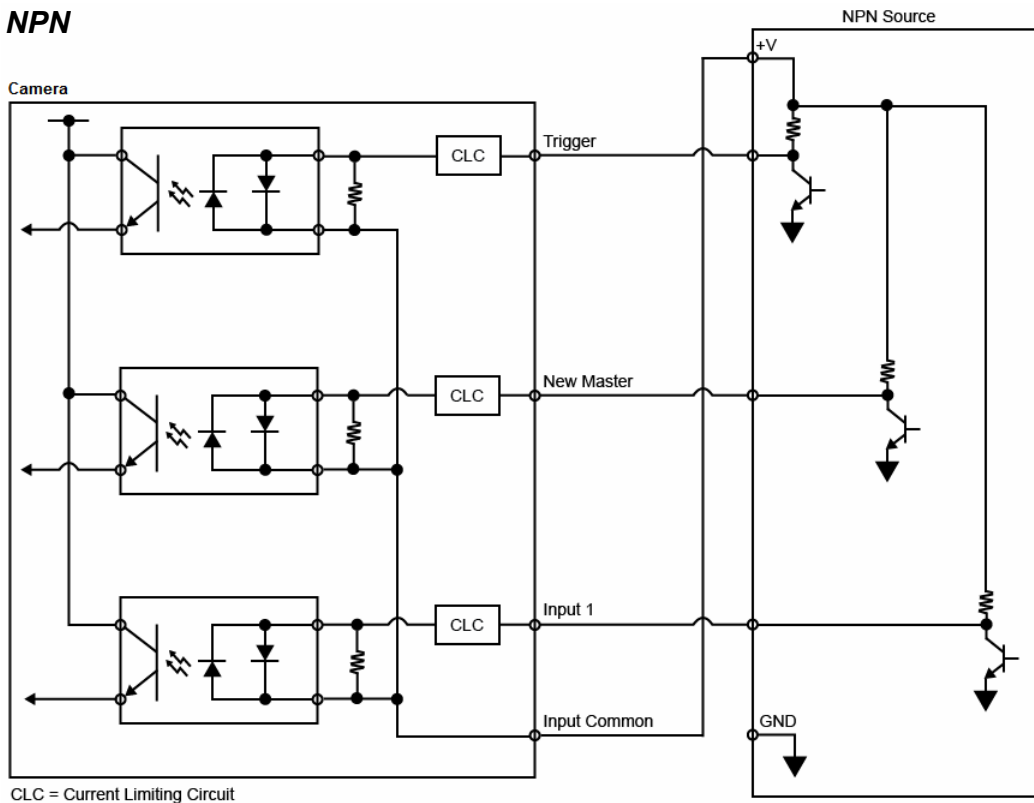

### PNP

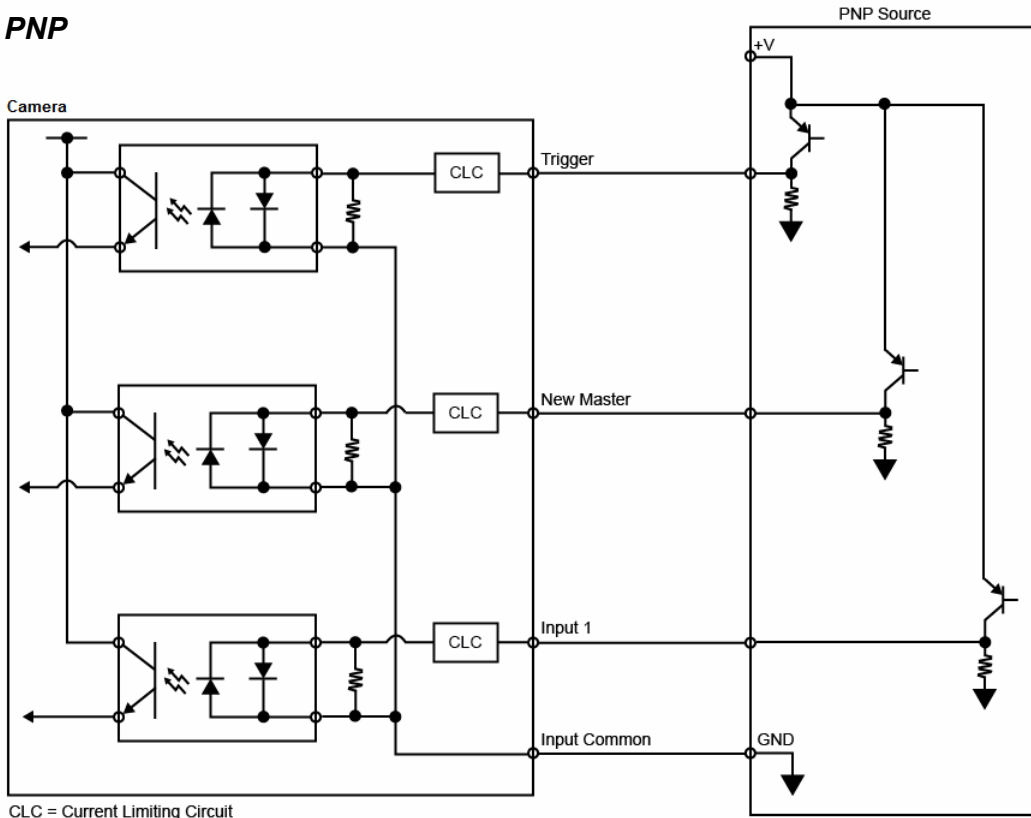

## Output Wiring

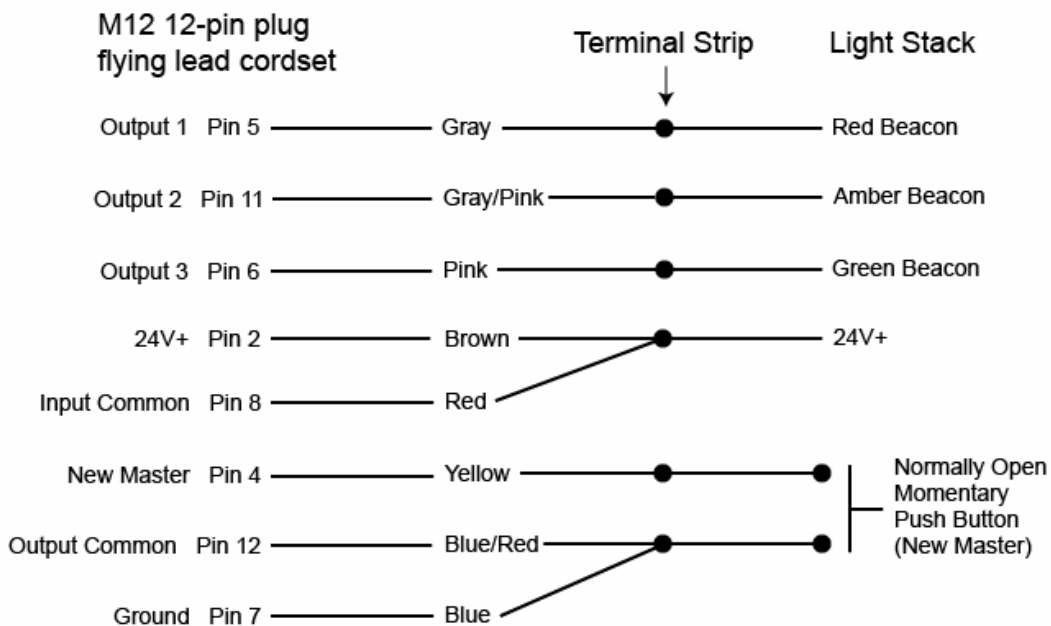

## Appendix C — Ground and Shield Considerations

Proper grounding is necessary for operator safety, noise reduction, and the protection of equipment from voltage transients. Buildings, including any steelwork, all circuits, and all junction boxes must be grounded directly to an earth ground in compliance with local and national electrical codes.

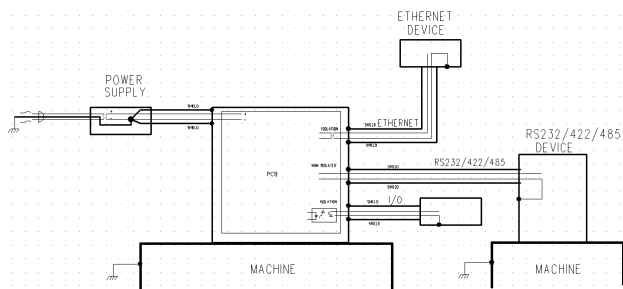

*An earth ground is provided through the cable shields and chassis of the scanner.*

### Ground Loops

Ground loops (signal degradation due to different ground potentials in communicating devices) can be eliminated or minimized by ensuring that both the host, scanner, and their power supplies are connected to a common earth ground.

### Grounding and Isolation

**Important:** Mounting a QX Hawk to grounded conductive material may cause communication problems or unreliable operation. If you need to mount the reader to a bracket or plate, be sure that a proper ground connection is available. If not, electrical isolation of the reader should be performed. Using Microscan's Isolation Mounting Kit, P/N 98-9000038-01, will ensure that no ground loop or other external electrical noise can occur through the reader.

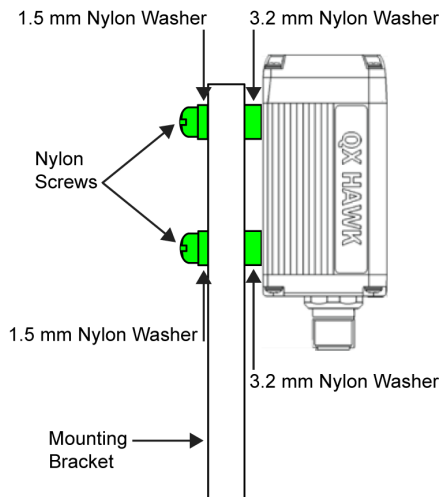

## Expected Power and Ground Connections for Proper Operation

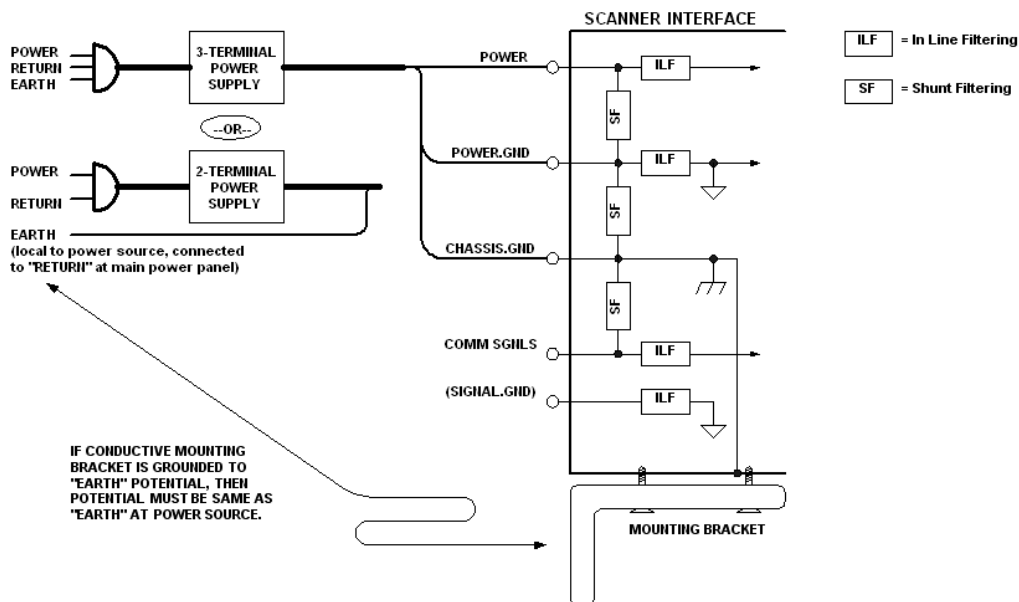

### Notes:

- Ensure that mounting bracket "Earth" is at the same potential as power source "Earth".
- Supply "Return" and "Earth" ground must be stable, low-impedance reference points.
- "2-Terminal Power Supply" must still provide an "Earth" connection to the imager.

# Appendix D — Flying Lead Cordset Pinouts

Microscan offers two flying lead cordsets for use in QX Hawk configurations:

- 61-000166-02 (Plug, Screw-On version)
- 61-000167-02 (Socket, Screw-On version)

The diagrams below show the correspondence of wire colors to pins.

## 61-000166-02 – M12 12-Pin Plug to Flying Leads

61-000166-02 connects to QX Hawk Connector B (serial) and QX-1 Connector 2.

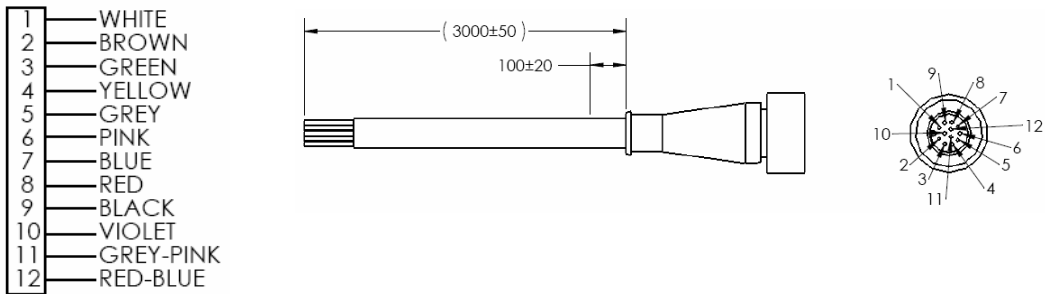

## 61-000167-02 – M12 12-Pin Socket to Flying Leads

61-000167-02 connects to QX Hawk Connector A and QX-1 Connectors 1 and 3.

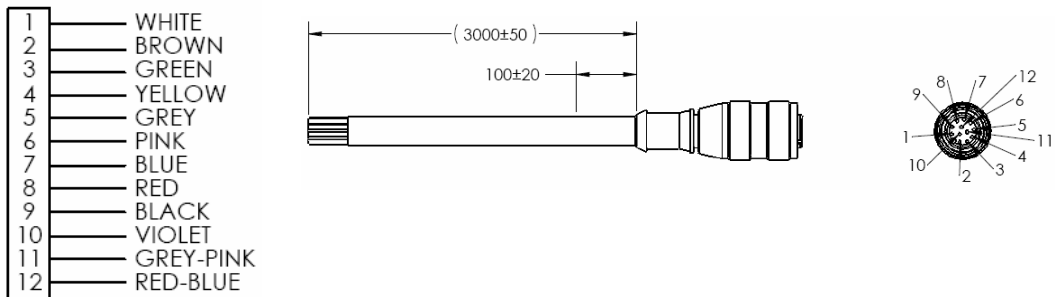

## Appendix E — Serial Commands

**Note:** For a list of utility commands such as defaults, read rate requests, device control options, and imager status requests, see [Serial Utility Commands](#).

<b>Communication</b>	
RS-232 A	<K100,baud rate,parity,stop bits,data bits>
RS-232 B	<K101,status,baud rate,parity,stop bits,data bits>
RS-422	<K102,status,baud rate,parity,stop bits,data bits>
Ethernet	<K126,status,IP address,subnet,gateway,IP address mode>
Ethernet TCP Ports	<K127,TCP Port 1,TCP Port 2>
Search and Configure Mode	<K128,ESP Search and Configure Mode>
EtherNet/IP	<K129,status>
RS-232 A Data Type	<K130,symbol data output,extended data,diagnostic output,external source processing mode>
RS-232 B Data Type	<K131,symbol data output,extended data,diagnostic output,external source processing mode>
RS-422 Data Type	<K132,symbol data output,extended data,diagnostic output,external source processing mode>
Ethernet TCP Port 1 Data Type	<K133,symbol data output,extended data,diagnostic output,external source processing mode>
Ethernet TCP Port 2 Data Type	<K134,symbol data output,extended data,diagnostic output,external source processing mode>
EtherNet/IP Port 1	<K136,symbol data output,extended data,diagnostic output,external source processing mode>
Preamble	<K141,status,preamble>
Postamble	<K142,status,postamble>
Response Timeout	<K143,response timeout>
LRC Status	<K145,status>
ACK/NAK Options	<K147,RES,REQ,STX,ETX,ACK,NAK>
Polling Mode Options	<K148,RES,REQ,STX,ETX,ACK,NAK>
Autoconfiguration Daisy Chain	<K150DAISY>
Protocol Selection	<K160,protocol,address>
External Data Routing	<K161,mode,destination port,ambles to source,echo to source,output at end of read cycle,output at ETX,output at timeout>
Array Communication Modes	<K162,mode,source,daisy chain i.d. status,daisy chain i.d.>
<b>Read Cycle</b>	
Trigger Mode / Trigger Filter Duration	<K200,trigger mode,leading edge trigger filter duration,trailing edge trigger filter duration>
Serial Trigger Character	<K201,serial trigger character>
External Trigger State	<K202,external trigger state>
End of Read Cycle	<K220,mode,read cycle timeout>
Decodes Before Output	<K221,number before output>
Multisymbol	<K222,number of symbols,multisymbol separator>
Serial Trigger Start Character	<K229,start character>

## Serial Commands

Serial Trigger Stop Character	<K230,stop character>
Capture Mode	<K241,mode,number of captures,rapid capture mode>
Capture Time	<K242,time before first capture,time between 1-2,time between 2-3,time between 3-4,time between 4-5,time between 5-6,time between 6-7,time between 7-8>
Store No Read Image	<K244,image storage type,image storage mode>
Image Processing Timeout	<K245,image processing timeout>
Number of Symbols in Field of View	<K518,number of symbols in field of view>

## Symbologies

Composite	<K453,symbology status,separator status,separator>
Aztec	<K458,status>
Micro QR Code	<K459,status>
Postal Symbologies	<K460,postal type,POSTNET status,PLANET status,USPS4CB status,POSTNET allow B and B' fields,Australia Post Allow 0 FCC>
Code 39	<K470,status,check character status,check character output status,large intercharacter gap,fixed symbol length status,fixed symbol length,full ASCII set>
Codabar	<K471,status,start/stop match status,start/stop output status,large intercharacter gap,fixed symbol length status,fixed symbol length,check character type,check character output status>
Interleaved 2 of 5	<K472,status,check character status,check character output status,symbol length 1,symbol length 2,guard bar status,range mode status>
UPC/EAN	<K473,UPC status,EAN status,supplemental status,separator status,separator character,supplemental type,UPC-E as UPC-A>
Code 128 / EAN 128	<K474,status,fixed symbol length status,fixed symbol length,EAN 128 status,output format,application record separator status,application record separator character,application record brackets,application record padding>
Code 93	<K475,status,fixed symbol length status,fixed symbol length>
PDF417	<K476,status,unused,fixed symbol length status,fixed symbol length,unused,codeword collection>
Pharmacode	<K477,status,fixed bar count status,fixed bar count,minimum bar count,bar width mode,direction,fixed threshold value,background>
Data Matrix	<K479,ECC 200 status,ECC 000 status,ECC 050 status,ECC 080 status,ECC 100 status,ECC 140 status,ECC 120 status,ECC 130 status>
QR Code	<K480,status>
BC412	<K481,status,check character output status,fixed symbol length status,fixed symbol length>
DataBar-14 (GS1 DataBar)	<K482,status>
DataBar Limited (GS1 DataBar)	<K483,status>
DataBar Expanded (GS1 DataBar)	<K484,status,fixed symbol length status,fixed symbol length>
MicroPDF417	<K485,status,unused,fixed length status,fixed symbol length>



<b>I/O Parameters</b>	
Calibration Options	<K529,gain,shutter speed,focus position,symbol type>window of interest framing>window of interest margin,unused>
Serial Verification	<K701,serial command echo status,serial command beep status,control/hex output>
Beeper	<K702,status>
Quality Output	<K704,quality output separator,decodes per trigger status>
Symbol Data Output	<K705,symbol data output status,when to output symbol data>
Read Duration Output	<K706,status,separator>
No Read Message	<K714,status,message>
Input 1	<K730,mode,active state>
Frame Information	<K734,output frame number,output coordinates>
ISO/IEC 16022 Parameter LED Configuration	<K737,unused,ISO/IEC 16022 parameter>
Green Flash LED	<K750,green flash LED status,targeting status,green flash duration>
Status Indicators	<K751,comm,bar graph,I/O 1,I/O 2>
EZ Trax Output	<K757,status,comm port,image mode,image format,JPEG quality,object info output,grade output>
Database Identifier Output	<K759,status,separator character>
EZ Button	<K770,global status,default on power-on,load configuration database,save for power-on>
EZ Button Modes	<K771,single beep,two beeps,three beeps,four beeps>
Trend Analysis Output 1	<K780,trend analysis mode,number of triggers,number to output on,decodes per trigger>
Trend Analysis Output 2	<K781,trend analysis mode,number of triggers,number to output on,decodes per trigger>
Trend Analysis Output 3	<K782,trend analysis mode,number of triggers,number to output on,decodes per trigger>
Diagnostics Output 1	<K790,unused,service unit>
Diagnostics Output 2	<K791,unused,service unit>
Diagnostics Output 3	<K792,unused,service unit>
Symbol Quality Output 1	<K800,output on symbol contrast,symbol contrast threshold,output on print growth,print growth threshold,output on axial non-uniformity,axial non-uniformity threshold,output on unused ECC,unused ECC threshold>
Symbol Quality Output 2	<K801,output on symbol contrast,symbol contrast threshold,output on print growth,print growth threshold,output on axial non-uniformity,axial non-uniformity threshold,output on unused ECC,unused ECC threshold>
Symbol Quality Output 3	<K802,output on symbol contrast,symbol contrast threshold,output on print growth,print growth threshold,output on axial non-uniformity,axial non-uniformity threshold,output on unused ECC,unused ECC threshold>
Output 1 Parameters	<K810,output on,output state,pulse width,output mode>
Output 2 Parameters	<K811,output on,output state,pulse width,output mode>
Output 3 Parameters	<K812,output on,output state,pulse width,output mode>

## Serial Commands

### Symbol Quality

Global Symbol Quality Output	<K708,quality output separator,output mode>
Data Matrix ISO/IEC 16022 Parameters	<K709,symbol contrast,print growth,axial non-uniformity,unused ECC>
Data Matrix Grading	<K710,percent cell damage,total read time,capture time,locate time,decode time,pixels per element,ECC level,matrix size,quiet zone,symbol angle>

### Matchcode

Matchcode	<K223,matchcode type,sequential matching,match start position,match length,wild card,sequence on no read,sequence on mismatch>
Master Symbol Database Size	<K224,number of master symbols>
New Master Pin	<K225,status>
Un-Delimited Serial Start Character	<K229,start character value>
Un-Delimited Serial Stop Character	<K230,stop character value>
Master Symbol	<K231,index,master symbol data>
Match Replace	<K735,status,replacement string>
Mismatch Replace	<K736,status,replacement string>

### Diagnostics

Time Since Reset (Read-only)	<K407,hours,minutes> (returns: hours,minutes)
Service Message	<K409,status,service message,threshold,resolution>
User-Defined Name	<K412,user-defined name>

### Camera Setup

Window of Interest	<K516,row pointer,column pointer,row depth,column width>
Focus Distance	<K525,focal distance,distance units,lens type>
Illumination (Standard QX Hawk Only)	<K539,mode,intensity>
Camera Settings	<K541,shutter speed,gain>
Sub-Sampling	<K542,sub-sampling>
Morphological Pre-Processing	<K550,status>
Morphological Operations	<K551,unused,operation,size>
External Illumination Mode	<K553,mode>

### Configuration Database

Number of Active Indexes	<K252,number of active indexes,sort database>
Configuration Database (CMOS)	<K255,index,shutter speed,gain,focal distance,sub-sampling,row pointer,column pointer,row depth,column width,symbol type,morphology operation,morphology size>
Configuration Database (CCD)	<K255,index,shutter speed,gain,focal distance,unused,row pointer,column pointer,row depth,column width,symbol type,morphology operation,morphology size>
Save Current Settings to Configuration Database	<K255+,index>
Load Current Settings from Configuration Database	<K255-,index>
Request Database Index Setting	<K255?,index>
Request All Database Settings	<K255?>
Database Mode	<K256,switch mode,frame count/time,image process looping,image dimensions>

**Output Format**

Format Extract	<K740,output index,start location,length>
Format Insert	<K741,output index,length,hex string>
Format Assign	<K742,symbol number,status>
Output Format Status	<K743,output format status>
Output Filter Configuration	<K744,filter number, symbology type,length,wildcard,placeholder,data,unused,database index>
Number of Filters	<K745,number of filters>

## Serial Command Format

Microscan readers are controlled by two types of serial commands: configuration commands and utility commands.

### Rules that apply to both configuration and utility commands

- Less than '<' and greater than '>' angle bracket characters enclose the commands.
- Commands and data are case sensitive. Characters must be entered as upper or lower case, as specified.

### Serial Utility Commands

Serial Utility Commands are sent during operations and are not followed by <A> or <Z>.

### Serial Configuration Commands (K Commands)

Microscan's serial configuration commands begin with a single "K" character followed by a 3-digit numeric character, comma-separated command fields, and an initializing command, as follows:

<K*numeric character,data,data,...etc.*><initializing command>

An initializing command <Z> or <A> may follow the command.

- <Z> initializes the imager's memory and saves for power-on.
- <A> initializes the imager's memory but does not save for power-on.

For example, to enable **UPC** and save the change for power-on, send <K473,1><Z>.

To change **Baud Rate** and reset without saving changes for power-on, send <K100,3><A>.

### Serial Configuration Command Conventions

- All command fields (except the last) must be followed by a comma (without a space).
- NULL cannot be used. The characters <, >, and , can be used, but only if entered as hex pairs (see [ASCII Character Entry Modifier](#)).
- All fields preceding a modified field must be included.
- If there is no change in preceding fields, then commas alone can be entered in these fields. For example, if only the last field in the following command is changing, <K100,4,1,0,0> can be entered as <K100,,,,0>.
- All fields *following* a modified field can be omitted. For example, to change Baud Rate only, send <K100,3>.

### Concatenating Configuration Commands

Commands can be concatenated (added together) in a single string. For example, <K145,1><K220,1><K450,1><A> enables **LRC**, sets **End of Read Cycle** mode to **New Trigger**, enables **Narrow Quiet Zone**, and resets the data buffers without saving the changes for power-on.

## Serial Command Status Request

To ensure that any command was received and accepted, send the **Show Reader Status** command: **<?>**.

The status of a specific serial command can be requested by entering the command followed by a question mark. For example, send **<K142?>** to request the status of **Postamble**.

## Entering Control Characters in Serial Commands

To enter control characters within a serial command, hold down the **Ctrl** key while typing the desired character.

*Example:* To enter a carriage return and line feed (**^M^J**), enter **<K141,1,CNTL-m CNTL-j>**

## Serial Configuration Commands

The following serial commands can be entered through ESP's Terminal to control QX Hawk functions. Detailed descriptions of command parameters are available in [Parameters](#).

### Communication

RS-232 A	< <b>K100</b> , <i>baud rate,parity,stop bits,data bits</i> >
RS-232 B	< <b>K101</b> , <i>status,baud rate,parity,stop bits,data bits</i> >
RS-422	< <b>K102</b> , <i>status,baud rate,parity,stop bits,data bits</i> >
Ethernet	< <b>K126</b> , <i>status,IP address,subnet,gateway,IP address mode</i> >
Ethernet TCP Ports	< <b>K127</b> , <i>TCP Port 1,TCP Port 2</i> >
Search and Configure Mode	< <b>K128</b> , <i>ESP Search and Configure Mode</i> >
EtherNet/IP	< <b>K129</b> , <i>status</i> >
RS-232 A Data Type	< <b>K130</b> , <i>symbol data output,extended data,diagnostic output,external source processing mode</i> >
RS-232 B Data Type	< <b>K131</b> , <i>symbol data output,extended data,diagnostic output,external source processing mode</i> >
RS-422 Data Type	< <b>K132</b> , <i>symbol data output,extended data,diagnostic output,external source processing mode</i> >
Ethernet TCP Port 1 Data Type	< <b>K133</b> , <i>symbol data output,extended data,diagnostic output,external source processing mode</i> >
Ethernet TCP Port 2 Data Type	< <b>K134</b> , <i>symbol data output,extended data,diagnostic output,external source processing mode</i> >
EtherNet/IP Port 1	< <b>K136</b> , <i>symbol data output,extended data,diagnostic output,external source processing mode</i> >
Preamble	< <b>K141</b> , <i>status,preamble</i> >
Postamble	< <b>K142</b> , <i>status,postamble</i> >
Response Timeout	< <b>K143</b> , <i>response timeout</i> >
LRC Status	< <b>K145</b> , <i>status</i> >
ACK/NAK Options	< <b>K147</b> , <i>RES,REQ,STX,ETX,ACK,NAK</i> >
Polling Mode Options	< <b>K148</b> , <i>RES,REQ,STX,ETX,ACK,NAK</i> >
Autoconfiguration Daisy Chain	< <b>K150</b> <i>DAISY</i> >
Protocol Selection	< <b>K160</b> , <i>protocol,address</i> >
External Data Routing	< <b>K161</b> , <i>mode,destination port,ambles to source,echo to source,output at end of read cycle,output at ETX,output at timeout</i> >
Array Communication Modes	< <b>K162</b> , <i>mode,source,daisy chain i.d. status,daisy chain i.d.</i> >

### RS-232 A

#### Baud Rate (RS-232 A)

Serial Cmd: <**K100**,*baud rate,parity,stop bits,data bits*>

Default: **8 = 115.2K**

Options:

0 = 600	1 = 1200	2 = 2400
3 = 4800	4 = 9600	5 = 19.2K
6 = 38.4K	7 = 57.6K	<b>8 = 115.2K</b>
9 = 230K		

**Parity (RS-232 A)**

Serial Cmd: <**K100**,baud rate,**parity**,stop bits,data bits>

Default: **0 = None**

Options: **0 = None**                      1 = Even                      2 = Odd

**Stop Bits (RS-232 A)**

Serial Cmd: <**K100**,baud rate,parity,**stop bits**,data bits>

Default: **0 = One**

Options: **0 = One**                      1 = Two

**Data Bits (RS-232 A)**

Serial Cmd: <**K100**,baud rate,parity,stop bits,**data bits**>

Default: **1 = Eight**

Options: 0 = Seven                      **1 = Eight**

**RS-232 B****Status (RS-232 B)**

Serial Cmd: <**K101**,**status**,baud rate,parity,stop bits,data bits>

Default: **1 = Enabled**

Options: 0 = Disabled                      **1 = Enabled**

**Baud Rate (RS-232 B)**

Serial Cmd: <**K101**,**status**,**baud rate**,parity,stop bits,data bits>

Default: **8 = 115.2K**

Options: 0 = 600                      1 = 1200                      2 = 2400  
           3 = 4800                      4 = 9600                      5 = 19.2K  
           6 = 38.4K                      7 = 57.6K                      **8 = 115.2K**  
           9 = 230K

**Parity (RS-232 B)**

Serial Cmd: <**K101**,**status**,baud rate,**parity**,stop bits,data bits>

Default: **0 = None**

Options: **0 = None**                      1 = Even                      2 = Odd

**Stop Bits (RS-232 B)**

Serial Cmd: <**K101**,**status**,baud rate,parity,**stop bits**,data bits>

Default: **0 = One**

Options: **0 = One**                      1 = Two

---

## Serial Commands

### Data Bits (RS-232 B)

Serial Cmd: <**K101**,*status*,*baud rate*,*parity*,*stop bits*,**data bits**>

Default: **1 = Eight**

Options: 0 = Seven **1 = Eight**

### RS-422

#### Status (RS-422)

Serial Cmd: <**K102**,*status*,*baud rate*,*parity*,*stop bits*,*data bits*>

Default: **0 = Disabled**

Options: **0 = Disabled** 1 = Enabled

#### Baud Rate (RS-422)

Serial Cmd: <**K102**,*status*,**baud rate**,*parity*,*stop bits*,*data bits*>

Default: **8 = 115.2K**

Options: 0 = 600 1 = 1200 2 = 2400  
3 = 4800 4 = 9600 5 = 19.2K  
6 = 38.4K 7 = 57.6K **8 = 115.2K**  
9 = 230K

#### Parity (RS-422)

Serial Cmd: <**K102**,*status*,*baud rate*,**parity**,*stop bits*,*data bits*>

Default: **0 = None**

Options: **0 = None** 1 = Even 2 = Odd

#### Stop Bits (RS-422)

Serial Cmd: <**K102**,*status*,*baud rate*,*parity*,**stop bits**,*data bits*>

Default: **0 = One**

Options: **0 = One** 1 = Two

#### Data Bits (RS-422)

Serial Cmd: <**K102**,*status*,*baud rate*,*parity*,*stop bits*,**data bits**>

Default: **1 = Eight**

Options: 0 = Seven **1 = Eight**

## Ethernet

### Status (Ethernet)

Serial Cmd: <**K126**,*status*,*IP address*,*subnet*,*gateway*,*IP address mode*>

Default: **1 = Enabled**

Options: 0 = Disabled **1 = Enabled**



### IP Address (Ethernet)

Serial Cmd: <**K126**,status,**IP address**,subnet,gateway,IP address mode>

Default: **192.168.0.100**

Options: 0.0.0.0 – 255.255.255.255

### Subnet (Ethernet)

Serial Cmd: <**K126**,status,IP address,**subnet**,gateway,IP address mode>

Default: **255.255.0.0**

Options: 0.0.0.0 – 255.255.255.255

### Gateway (Ethernet)

Serial Cmd: <**K126**,status,IP address,subnet,**gateway**,IP address mode>

Default: **0.0.0.0**

Options: 0.0.0.0 – 255.255.255.255

### IP Address Mode (Ethernet)

Serial Cmd: <**K126**,status,IP address,subnet,gateway,**IP address mode**>

Default: **0 = Static**

Options: **0 = Static**                      1 = DHCP

### Ethernet TCP Ports

#### TCP Port 1 (Ethernet TCP Ports)

Serial Cmd: <**K127**,**TCP Port 1**,TCP Port 2>

Default: **2001**

Options: 1024 – 65535

#### TCP Port 2 (Ethernet TCP Ports)

Serial Cmd: <**K127**,TCP Port 1,**TCP Port 2**>

Default: **2003**

Options: 1024 – 65535

### RS-232 A Data Type

#### Symbol Data Output (RS-232 A Data Type)

Serial Cmd: <**K130**,**symbol data output**,extended data,diagnostic output,external source processing mode>

Default: **1 = Enabled**

Options: 0 = Disabled                      **1 = Enabled**

---

## Serial Commands

### Extended Data (RS-232 A Data Type)

Serial Cmd: <**K130**,symbol data output,**extended data**,diagnostic output,external source processing mode>

Default: **1 = Enabled**

Options: 0 = Disabled **1 = Enabled**

### Diagnostic Output (RS-232 A Data Type)

Serial Cmd: <**K130**,symbol data output,extended data,**diagnostic output**,external source processing mode>

Default: **1 = Enabled**

Options: 0 = Disabled **1 = Enabled**

### External Source Processing Mode (RS-232 A Data Type)

Serial Cmd: <**K130**,symbol data output,extended data,diagnostic output,**external source processing mode**>

Default: **1 = Command**

Options: 0 = Disabled **1 = Command** 2 = Data

## RS-232 B Data Type

### Symbol Data Output (RS-232 B Data Type)

Serial Cmd: <**K131**,**symbol data output**,extended data,diagnostic output,external source processing mode>

Default: **1 = Enabled**

Options: 0 = Disabled **1 = Enabled**

### Extended Data (RS-232 B Data Type)

Serial Cmd: <**K131**,symbol data output,**extended data**,diagnostic output,external source processing mode>

Default: **1 = Enabled**

Options: 0 = Disabled **1 = Enabled**

### Diagnostic Output (RS-232 B Data Type)

Serial Cmd: <**K131**,symbol data output,extended data,**diagnostic output**,external source processing mode>

Default: **1 = Enabled**

Options: 0 = Disabled **1 = Enabled**

### External Source Processing Mode (RS-232 B Data Type)

Serial Cmd: <**K131**,symbol data output,extended data,diagnostic output,**external source processing mode**>

Default: **1 = Command**

Options: 0 = Disabled **1 = Command** 2 = Data

## RS-422 Data Type

### Symbol Data Output (RS-422 Data Type)

*Serial Cmd:* <**K132**,**symbol data output**,*extended data,diagnostic output,external source processing mode*>

*Default:* **1 = Enabled**

*Options:* 0 = Disabled **1 = Enabled**

### Extended Data (RS-422 Data Type)

*Serial Cmd:* <**K132**,*symbol data output,***extended data**,*diagnostic output,external source processing mode*>

*Default:* **1 = Enabled**

*Options:* 0 = Disabled **1 = Enabled**

### Diagnostic Output (RS-422 Data Type)

*Serial Cmd:* <**K132**,*symbol data output,extended data,***diagnostic output**,*external source processing mode*>

*Default:* **1 = Enabled**

*Options:* 0 = Disabled **1 = Enabled**

### External Source Processing Mode (RS-422 Data Type)

*Serial Cmd:* <**K132**,*symbol data output,extended data,diagnostic output,***external source processing mode**>

*Default:* **1 = Command**

*Options:* 0 = Disabled **1 = Command** 2 = Data

## Ethernet TCP Port 1 Data Type

### Symbol Data Output (Ethernet TCP Port 1 Data Type)

*Serial Cmd:* <**K133**,**symbol data output**,*extended data,diagnostic output,external source processing mode*>

*Default:* **1 = Enabled**

*Options:* 0 = Disabled **1 = Enabled**

### Extended Data (Ethernet TCP Port 1 Data Type)

*Serial Cmd:* <**K133**,*symbol data output,***extended data**,*diagnostic output,external source processing mode*>

*Default:* **1 = Enabled**

*Options:* 0 = Disabled **1 = Enabled**

---

## Serial Commands

### Diagnostic Output (Ethernet TCP Port 1 Data Type)

Serial Cmd: <**K133**,symbol data output,extended data,**diagnostic output**,external source processing mode>

Default: **1 = Enabled**

Options: 0 = Disabled **1 = Enabled**

### External Source Processing Mode (Ethernet TCP Port 1 Data Type)

Serial Cmd: <**K133**,symbol data output,extended data,diagnostic output,**external source processing mode**>

Default: **1 = Command**

Options: 0 = Disabled **1 = Command** 2 = Data

### Ethernet TCP Port 2 Data Type

#### Symbol Data Output (Ethernet TCP Port 2 Data Type)

Serial Cmd: <**K134**,symbol data output,extended data,diagnostic output,external source processing mode>

Default: **1 = Enabled**

Options: 0 = Disabled **1 = Enabled**

#### Extended Data (Ethernet TCP Port 2 Data Type)

Serial Cmd: <**K134**,symbol data output,**extended data**,diagnostic output,external source processing mode>

Default: **1 = Enabled**

Options: 0 = Disabled **1 = Enabled**

#### Diagnostic Output (Ethernet TCP Port 2 Data Type)

Serial Cmd: <**K134**,symbol data output,extended data,**diagnostic output**,external source processing mode>

Default: **1 = Enabled**

Options: 0 = Disabled **1 = Enabled**

#### External Source Processing Mode (Ethernet TCP Port 2 Data Type)

Serial Cmd: <**K134**,symbol data output,extended data,diagnostic output,**external source processing mode**>

Default: **1 = Command**

Options: 0 = Disabled **1 = Command** 2 = Data

### Preamble

#### Status (Preamble)

Serial Cmd: <**K141**,status,preamble character(s)>

Default: **0 = Disabled**

Options: **0 = Disabled** 1 = Enabled

**Preamble Characters (Preamble)**

Serial Cmd: <**K141**,status,*preamble character(s)*>

Default: **CR (0x0D)**

Options: 1 – 4 ASCII characters

**Postamble****Status (Postamble)**

Serial Cmd: <**K142**,status,*postamble character(s)*>

Default: **1 = Enabled**

Options: 0 = Disabled **1 = Enabled**

**Postamble Characters (Postamble)**

Serial Cmd: <**K142**,status,*postamble character(s)*>

Default: **CR LF (0x0D 0x0A)**

Options: 1 – 4 ASCII characters

**Response Timeout**

Serial Cmd: <**K143**,*response timeout*>

Default: **5 (x10 ms = 50)**

Options: 0 to 255 (x10 ms)

**LRC Status**

Serial Cmd: <**K145**,status>

Default: **0 = Disabled**

Options: **0 = Disabled** 1 = Enabled

**ACK/NAK Options**

Serial Cmd: <**K147**,RES,REQ,STX,ETX,ACK,NAK>

**RES,REQ,STX,ETX,ACK,NAK Defaults (ACK/NAK Options)**

RES: (Reset) 00 (disabled)

REQ: (Request) 00 (disabled)

STX: (Start of Text) 00 (disabled)

ETX: (End of Text) 00 (disabled)

ACK: (Acknowledge) 06

NAK: (Negative Acknowledge) 15

## Polling Mode Options

Serial Cmd: <**K148**,RES,REQ,STX,ETX,ACK,NAK>

### RES,REQ,STX,ETX,ACK,NAK Defaults (Polling Mode Options)

RES: (Reset)	04
REQ: (Request)	05
STX: (Start of Text)	02
ETX: (End of Text)	03
ACK: (Acknowledge)	06
NAK: (Negative Acknowledge)	15

## Autoconfiguration Daisy Chain

Serial Cmd: <**K150DAISY**>

## ASCII Character Entry Modifier

Commands that require ASCII text fields, such as **Preamble** and **Postamble** commands, can be sent to the imager as hex pairs (see Appendix G, [ASCII Table](#), for conversions).

Serial Cmd Format: <**Knnhh,00-FF**>

To enter ASCII fields as hex values (00 to FF), add a lower-case **h** directly after the command's **K** number, and then enter the hex value that corresponds with the desired ASCII character.

Example:

Serial Cmd: <**K142**,status,**postamble character(s)**>

The ASCII characters **<**, **>**, and **,** can only be entered as hex pairs. So, to make **>** the postamble in the symbol decode output, enter the **Postamble** command as follows:

<**K142h**,**3E**>

Note that the "status" field contains only a **,**. This is because the only field that is being changed is the "postamble character(s)" field. (See [Serial Configuration Command Conventions](#) for a more detailed explanation of this command shortcut.)

## Protocol Selection

### Protocol (Protocol Selection)

Serial Cmd: <**K160**,**protocol**,address,protocol port>

Options:	0 = Point-to-Point
	1 = Point-to-Point with RTS/CTS
	2 = Point-to-Point with XON/XOFF
	3 = Point-to-Point with RTS/CTS and XON/XOFF
	4 = ACK/NAK
	5 = Polling Mode

**Address (Protocol Selection)**

*Serial Cmd:* <**K160**,*protocol*,**address**,*protocol port*>

*Default:* **1**

*Options:* 1 – 50

1 = Poll address 0x1C, select address 0x1D

2 = Poll address 0x1E, select address 0x1F

...

50 = Poll address 0x7E, select address 0x7F

**Protocol Port (Protocol Selection)**

*Serial Cmd:* <**K160**,*protocol*,*address*,**protocol port**>

*Default:* **0**

*Options:* 0 – 1

0 = Main RS-232 on QX Hawk Connector A

1 = RS-422/485 on QX Hawk Connector B

**External Data Routing****Mode (External Data Routing)**

*Serial Cmd:* <**K161**,**mode**,*destination port*,*ambles to source*,*echo to source*,*output at end of read cycle*,*output at ETX*,*output at timeout*>

*Default:* **0 = Disabled**

*Options:* **0 = Disabled**

1 = Transparent

2 = Half Duplex

3 = Full Duplex

4 = Customized

**Destination Port (External Data Routing)**

*Serial Cmd:* <**K161**,**mode**,**destination port**,*ambles to source*,*echo to source*,*output at end of read cycle*,*output at ETX*,*output at timeout*>

*Default:* **0 = RS-232 on QX Hawk Connector A**

*Options:* **0 = RS-232 on QX Hawk Connector A**

1 = RS-232 on QX Hawk Connector B

2 = RS-422 on QX Hawk Connector B

4 = Ethernet TCP Port 1

5 = Ethernet TCP Port 2

6 = EtherNet/IP

---

## Serial Commands

### Ambles to Source (External Data Routing)

Serial Cmd: <**K161**,mode,destination port,**ambles to source**,echo to source,output at end of read cycle,output at ETX,output at timeout>

Default: **0 = Disabled**

Options: **0 = Disabled** 1 = Enabled

### Echo to Source (External Data Routing)

Serial Cmd: <**K161**,mode,destination port,ambles to source,**echo to source**,output at end of read cycle,output at ETX,output at timeout>

Default: **0 = Disabled**

Options: **0 = Disabled** 1 = Enabled

### Output at End of Read Cycle (External Data Routing)

Serial Cmd: <**K161**,mode,destination port,ambles to source,echo to source,**output at end of read cycle**,output at ETX,output at timeout>

Default: **0 = Disabled**

Options: **0 = Disabled** 1 = Enabled

### Output at ETX (External Data Routing)

Serial Cmd: <**K161**,mode,destination port,ambles to source,echo to source,output at end of read cycle,**output at ETX**,output at timeout>

Default: **CR (0x0D)**

Options: Any 7-bit ASCII character

### Output at Timeout (External Data Routing)

Serial Cmd: <**K161**,mode,destination port,ambles to source,echo to source,output at end of read cycle,output at ETX,**output at timeout**>

Default: **200 (x10 ms = 2 seconds)**

Options: 0 – 65535

## Array Communication Modes

### Mode (Array Communication Modes)

Serial Cmd: <**K162**,mode,source,daisy chain i.d. status,daisy chain i.d.>

Default: **0 = Disabled**

Options: **0 = Disabled** 1 = Daisy Chain



**Source (Array Communication Modes)**

*Serial Cmd:* <**K162**,mode,**source**,*daisy chain i.d. status*,*daisy chain i.d.*>

*Default:* **1 = RS-232 on QX Hawk Connector B**

*Options:* 0 = RS-232 on QX Hawk Connector A

**1 = RS-232 on QX Hawk Connector B**

2 = RS-422 on QX Hawk Connector B

4 = Ethernet TCP Port 1

5 = Ethernet TCP Port 2

**Daisy Chain ID Status (Array Communication Modes)**

*Serial Cmd:* <**K162**,mode,**source**,**daisy chain i.d. status**,*daisy chain i.d.*>

*Default:* **0 = Disabled**

*Options:* **0 = Disabled**                      1 = Enabled

**Daisy Chain ID (Array Communication Modes)**

*Serial Cmd:* <**K162**,mode,**source**,*daisy chain i.d. status*,**daisy chain i.d.**>

*Default:* **1/**

*Options:* One or two ASCII characters.

---

## Serial Commands

### Read Cycle

Trigger Mode / Trigger Filter Duration	< <b>K200</b> ,trigger mode,leading edge trigger filter duration,trailing edge trigger filter duration>
Serial Trigger Character	< <b>K201</b> ,serial trigger character>
External Trigger State	< <b>K202</b> ,external trigger state>
End of Read Cycle	< <b>K220</b> ,mode,read cycle timeout>
Decodes Before Output	< <b>K221</b> ,number before output>
Multisymbol	< <b>K222</b> ,number of symbols,multisymbol separator>
Serial Trigger Start Character	< <b>K229</b> ,start character>
Serial Trigger Stop Character	< <b>K230</b> ,stop character>
Capture Mode	< <b>K241</b> ,mode,number of captures,rapid capture mode>
Capture Time	< <b>K242</b> ,time before first capture,time between 1-2,time between 2-3,time between 3-4,time between 4-5,time between 5-6,time between 6-7,time between 7-8>
Store No Read Image	< <b>K244</b> ,image storage type,image storage mode>
Image Processing Timeout	< <b>K245</b> ,image processing timeout>
Number of Symbols in Field of View	< <b>K518</b> ,number of symbols in field of view>

### Trigger Mode / Filter Duration

#### Trigger Mode (Trigger Mode / Filter Duration)

Serial Cmd: <**K200**,trigger mode,leading edge trigger filter,trailing edge trigger filter>

Default: **0 = Continuous Read**

Options: **0 = Continuous Read**  
1 = Continuous Read 1 Output  
2 = External Level  
3 = External Edge  
4 = Serial Data  
5 = Serial Data and Edge

#### Leading Edge Trigger Filter (Trigger Mode / Filter Duration)

Serial Cmd: <**K200**,trigger mode,leading edge trigger filter,trailing edge trigger filter>

Default: **313** (~10 ms)

Options: 1 to 65535 (x 32.0 µs)

#### Trailing Edge Trigger Filter (Trigger Mode / Filter Duration)

Serial Cmd: <**K200**,trigger mode,leading edge trigger filter,trailing edge trigger filter>

Default: **313** (~10 ms)

Options: 1 to 65535 (x 32.0 µs)

### Serial Trigger Character (Delimited)

Serial Cmd: <**K201**,serial trigger character>

Default: **Space (0x20)**

Options: Any 7-bit ASCII character

## External Trigger State

Serial Cmd: <**K202,active state**>

Default: **1 = Positive**

Options: 0 = Negative                      **1 = Positive**

## End of Read Cycle

### End of Read Cycle Mode (End of Read Cycle)

Serial Cmd: <**K220,end of read cycle mode,read cycle timeout**>

Default: **0 = Timeout**

Options: **0 = Timeout**  
 1 = New Trigger  
 2 = Timeout or New Trigger  
 3 = Last Frame  
 4 = Last Frame or New Trigger

### Read Cycle Timeout (End of Read Cycle)

Serial Cmd: <**K220,end of read cycle,read cycle timeout**>

Default: **100 (x10 ms = 1 second)**

Options: 1 to 65535

## Decodes Before Output

Serial Cmd: <**K221,decodes before output,mode**>

Default: **1**

Options: 1 to 255

### Mode (Decodes Before Output)

Serial Cmd: <**K221,decodes before output,mode**>

Default: **0 = Non-Consecutive**

Options: **0 = Non-Consecutive**                      1 = Consecutive

## Multisymbol

### Number of Symbols (Multisymbol)

Serial Cmd: <**K222,number of symbols,multisymbol separator**>

Default: **1**

Options: 1 to 100

### Multisymbol Separator (Multisymbol)

Serial Cmd: <**K222,number of symbols,multisymbol separator**>

Default: **, (comma)**

Options: Any 7-bit ASCII character

---

## Serial Commands

### **Serial Trigger Start Character (Non-Delimited)**

Serial Cmd: <K229,start character>

Default: **NULL (0x00)**

Options: Two hex digits representing any ASCII character except <, >, XON, and XOFF.

### **Serial Trigger Stop Character (Non-Delimited)**

Serial Cmd: <K230,stop character>

Default: **NULL (0x00)**

Options: Two hex digits representing any ASCII character except <, >, XON, and XOFF.

### **Image Processing Timeout**

Serial Cmd: <K245,processing timeout>

Default: **200 (0.2 seconds)**

Options: 1 to 65535

## Symbologies

Composite	< <b>K453</b> ,symbology status,separator status,separator>
Aztec	< <b>K458</b> ,status>
Micro QR Code	< <b>K459</b> ,status>
Postal Symbologies	< <b>K460</b> ,postal type,POSTNET status,PLANET status,USPS4CB status,POSTNET allow B and B' fields,Australia Post Allow 0 FCC>
Code 39	< <b>K470</b> ,status,check character status,check character output status,large intercharacter gap,fixed symbol length status,fixed symbol length,full ASCII set>
Codabar	< <b>K471</b> ,status,start/stop match status,start/stop output status,large intercharacter gap,fixed symbol length status,fixed symbol length,check character type,check character output status>
Interleaved 2 of 5	< <b>K472</b> ,status,check character status,check character output status,symbol length 1,symbol length 2,guard bar status,range mode status>
UPC/EAN	< <b>K473</b> ,UPC status,EAN status,supplemental status,separator status,separator character,supplemental type,UPC-E as UPC-A>
Code 128 / EAN 128	< <b>K474</b> ,status,fixed symbol length status,fixed symbol length,EAN 128 status,output format,application record separator status,application record separator character,application record brackets,application record padding>
Code 93	< <b>K475</b> ,status,fixed symbol length status,fixed symbol length>
PDF417	< <b>K476</b> ,status,unused,fixed symbol length status,fixed symbol length,unused,codeword collection>
Pharmacode	< <b>K477</b> ,status,fixed bar count status,fixed bar count,minimum bar count,bar width mode,direction,fixed threshold value,background>
Data Matrix	< <b>K479</b> ,ECC 200 status,ECC 000 status,ECC 050 status,ECC 080 status,ECC 100 status,ECC 140 status,ECC 120 status,ECC 130 status>
QR Code	< <b>K480</b> ,status>
BC412	< <b>K481</b> ,status,check character output status,fixed symbol length status,fixed symbol length>
DataBar-14 (GS1 DataBar)	< <b>K482</b> ,status>
DataBar Limited (GS1 DataBar)	< <b>K483</b> ,status>
DataBar Expanded (GS1 DataBar)	< <b>K484</b> ,status,fixed symbol length status,fixed symbol length>
MicroPDF417	< <b>K485</b> ,status,unused,fixed length status,fixed symbol length>

## Composite

### Symbology Status (Composite)

Serial Cmd: <**K453**,symbology status,separator status,separator>

Default: **0 = Disabled**

Options: **0 = Disabled**                      1 = Enabled                      2 = Required

### Separator Status (Composite)

Serial Cmd: <**K453**,symbology status,**separator status**,separator>

Default: **0 = Disabled**

Options: **0 = Disabled**                      1 = Enabled

---

## Serial Commands

### Separator (Composite)

Serial Cmd: <**K453**,*symbology status,separator status,separator*>

Default: **, (comma)**

Options: Any 7-bit ASCII character

### Code 39

#### Status (Code 39)

Serial Cmd: <**K470,status,check character status,check character output status,large intercharacter gap,fixed symbol length status,fixed symbol length,full ASCII set**>

Default: **1 = Enabled**

Options: 0 = Disabled **1 = Enabled**

#### Check Character Status (Code 39)

Serial Cmd: <**K470,status,check character status,check character output status,large intercharacter gap,fixed symbol length status,fixed symbol length,full ASCII set**>

Default: **0 = Disabled**

Options: **0 = Disabled** 1 = Enabled

#### Check Character Output Status (Code 39)

Serial Cmd: <**K470,status,check character status,check character output status,large intercharacter gap,fixed symbol length status,fixed symbol length,full ASCII set**>

Default: **0 = Disabled**

Options: **0 = Disabled** 1 = Enabled

#### Large Intercharacter Gap (Code 39)

Serial Cmd: <**K470,status,check character status,check character output status,large intercharacter gap,fixed symbol length status,fixed symbol length,full ASCII set**>

Default: **0 = Disabled**

Options: **0 = Disabled** 1 = Enabled

#### Fixed Symbol Length Status (Code 39)

Serial Cmd: <**K470,status,check character status,check character output status,large intercharacter gap,fixed symbol length status,fixed symbol length,full ASCII set**>

Default: **0 = Disabled**

Options: **0 = Disabled** 1 = Enabled

**Fixed Symbol Length (Code 39)**

*Serial Cmd:* <**K470**,status,check character status,check character output status,large intercharacter gap,fixed symbol length status,**fixed symbol length**,full ASCII set>

*Default:* **10**

*Options:* 1 to 128

**Full ASCII Set (Code 39)**

*Serial Cmd:* <**K470**,status,check character status,check character output status,large intercharacter gap,fixed symbol length status,fixed symbol length,**full ASCII set**>

*Default:* **0 = Disabled**

*Options:* **0 = Disabled** 1 = Enabled

**Codabar****Status (Codabar)**

*Serial Cmd:* <**K471**,**status**,start/stop match,start/stop output,large intercharacter gap,fixed symbol length status,symbol length,check character type,check character output>

*Default:* **0 = Disabled**

*Options:* **0 = Disabled** 1 = Enabled

**Start/Stop Match (Codabar)**

*Serial Cmd:* <**K471**,status,**start/stop match**,start/stop output,large intercharacter gap,fixed symbol length status,symbol length,check character type,check character output>

*Default:* **1 = Enabled**

*Options:* 0 = Disabled **1 = Enabled**

**Start/Stop Output (Codabar)**

*Serial Cmd:* <**K471**,status,start/stop match,**start/stop output**,large intercharacter gap,fixed symbol length status,symbol length,check character type,check character output>

*Default:* **1 = Enabled**

*Options:* 0 = Disabled **1 = Enabled**

**Large Intercharacter Gap (Codabar)**

*Serial Cmd:* <**K471**,status,start/stop match,start/stop output,**large intercharacter gap**,fixed symbol length status,symbol length,check character type,check character output>

*Default:* **0 = Disabled**

*Options:* **0 = Disabled** 1 = Enabled

---

## Serial Commands

### Fixed Symbol Length Status (Codabar)

Serial Cmd: <**K471**,status,start/stop match,start/stop output,large intercharacter gap,**fixed symbol length status**,symbol length,check character type,check character output>

Default: **0 = Disabled**

Options: **0 = Disabled**                      1 = Enabled

### Symbol Length (Codabar)

Serial Cmd: <**K471**,status,start/stop match,start/stop output,large intercharacter gap,fixed symbol length status,**symbol length**,check character type,check character output>

Default: **10**

Options: 1 to 128

### Check Character Type (Codabar)

Serial Cmd: <**K471**,status,start/stop match,start/stop output,large intercharacter gap,fixed symbol length status,symbol length,**check character type**,check character output>

Default: **0 = Disabled**

Options: **0 = Disabled**

1 = Mod 16

2 = NW7 (Mod 11)

3 = Both Mod 16 and NW7 (Mod 11)

### Check Character Output (Codabar)

Serial Cmd: <**K471**,status,start/stop match,start/stop output,large intercharacter gap,fixed symbol length status,symbol length,check character type,**check character output**>

Default: **0 = Disabled**

Options: **0 = Disabled**                      1 = Enabled

### Interleaved 2 of 5

#### Status (Interleaved 2 of 5)

Serial Cmd: <**K472**,**status**,check character status,check character output status,symbol length #1,symbol length #2,guard bar status,range mode status>

Default: **1 = Enabled**

Options: 0 = Disabled                      **1 = Enabled**

#### Check Character Status (Interleaved 2 of 5)

Serial Cmd: <**K472**,status,**check character status**,check character output status,symbol length #1,symbol length #2,guard bar status,range mode status>

Default: **0 = Disabled**

Options: **0 = Disabled**                      1 = Enabled



**Check Character Output Status (Interleaved 2 of 5)**

*Serial Cmd:* <**K472**,status,check character status,**check character output status**,symbol length #1,symbol length #2,guard bar status,range mode status>

*Default:* **0 = Disabled**

*Options:* **0 = Disabled** 1 = Enabled

**Symbol Length #1 (Interleaved 2 of 5)**

*Serial Cmd:* <**K472**,status,check character status,check character output,**symbol length #1**,symbol length #2,guard bar status,range mode status>

*Default:* **16**

*Options:* 0 to 128

**Symbol Length #2 (Interleaved 2 of 5)**

*Serial Cmd:* <**K472**,status,check character status,check character output,symbol length #1,**symbol length #2**,guard bar status,range mode status>

*Default:* **6**

*Options:* 0 to 128

**Guard Bar Status (Interleaved 2 of 5)**

*Serial Cmd:* <**K472**,status,check character status,check character output,symbol length #1,symbol length #2,**guard bar status**,range mode status>

*Default:* **0 = Disabled**

*Options:* **0 = Disabled** 1 = Enabled

**Range Mode Status (Interleaved 2 of 5)**

*Serial Cmd:* <**K472**,status,check character status,check character output,symbol length #1,symbol length #2,guard bar status,**range mode status**>

*Default:* **1 = Enabled**

*Options:* 0 = Disabled **1 = Enabled**

**UPC/EAN****UPC Status (UPC/EAN)**

*Serial Cmd:* <**K473**,**UPC status**,EAN status,supplementals status,separator status,separator character,supplemental type,format UPC-E as UPC-A>

*Default:* **0 = Disabled**

*Options:* **0 = Disabled**

1 = Enabled

---

## Serial Commands

### EAN Status (UPC/EAN)

*Serial Cmd:* <**K473**,UPC status,**EAN status**,supplementals status,separator status,separator character,supplemental type,format UPC-E as UPC-A>

*Default:* **1 = Enabled**

*Options:* 0 = Disabled **1 = Enabled**

### Supplementals Status (UPC/EAN)

*Serial Cmd:* <**K473**,UPC status,EAN status,**supplementals status**,separator status,separator character,supplemental type,format UPC-E as UPC-A>

*Default:* **0 = Disabled**

*Options:* **0 = Disabled** 1 = Enabled 2 = Required

### Separator Status (UPC/EAN)

*Serial Cmd:* <**K473**,UPC status,EAN status,supplementals status,**separator status**,separator character,supplemental type,format UPC-E as UPC-A>

*Default:* **0 = Disabled**

*Options:* **0 = Disabled** 1 = Enabled

### Separator Character (UPC/EAN)

*Serial Cmd:* <**K473**,UPC status,EAN status,supplementals status,separator status,**separator character**,supplemental type,format UPC-E as UPC-A>

*Default:* **, (comma)**

*Options:* Any 7-bit ASCII character

### Supplemental Type (UPC/EAN)

*Serial Cmd:* <**K473**,UPC status,EAN status,supplementals status,separator status,separator character,**supplemental type**,format UPC-E as UPC-A>

*Default:* **0 = Both**

*Options:* **0 = Both** 1 = 2 characters only 2 = 5 characters only

### Format UPC-E as UPC-A (UPC/EAN)

*Serial Cmd:* <**K473**,UPC status,EAN status,supplementals status,separator status,separator character,supplemental type,**format UPC-E as UPC-A**>

*Default:* **0 = Disabled**

*Options:* **0 = Disabled** 1 = Enabled

**Code 128 / EAN 128****Status (Code 128 / EAN 128)**

*Serial Cmd:* <**K474,status**,fixed symbol length status,fixed symbol length,EAN 128 status,output format,application record separator status,application record separator character,application record brackets,application record padding,separation factor>

*Default:* **0 = Disabled**

*Options:* **0 = Disabled**

1 = Enabled

**Fixed Symbol Length Status (Code 128 / EAN 128)**

*Serial Cmd:* <**K474,status,fixed symbol length status**,fixed symbol length,EAN 128 status,output format,application record separator status,application record separator character,application record brackets,application record padding,separation factor>

*Default:* **0 = Disabled**

*Options:* **0 = Disabled** 1 = Enabled

**Fixed Symbol Length (Code 128 / EAN 128)**

*Serial Cmd:* <**K474,status,fixed symbol length status,fixed symbol length**,EAN 128 status,output format,application record separator status,application record separator character,application record brackets,application record padding,separation factor>

*Default:* **10**

*Options:* 1 to 128

**EAN 128 Status (Code 128 / EAN 128)**

*Serial Cmd:* <**K474,status,fixed symbol length status,fixed symbol length,EAN 128 status**,output format,application record separator status,application record separator character,application record brackets,application record padding,separation factor>

*Default:* **1 = Enabled**

*Options:* 0 = Disabled **1 = Enabled** 2 = Required

**Output Format (Code 128 / EAN 128)**

*Serial Cmd:* <**K474,status,fixed symbol length status,fixed symbol length,EAN 128 status,output format**,application record separator status,application record separator character,application record brackets,application record padding,separation factor>

*Default:* **0 = Standard**

*Options:* **0 = Standard** 1 = Application

### Application Record Separator Status (Code 128 / EAN 128)

Serial Cmd: <K474,status,fixed symbol length status,fixed symbol length,EAN 128 status,output format,application record separator status,application record separator character,application record brackets,application record padding,separation factor>

Default: **0 = Disabled**

Options: **0 = Disabled** 1 = Enabled

### Application Record Separator Character (Code 128 / EAN 128)

Serial Cmd: <K474,status,fixed symbol length status,fixed symbol length,EAN 128 status,output format,application record separator status,application record separator character,application record brackets,application record padding,separation factor>

Default: **, (comma)**

Options: Any 7-bit ASCII character

### Application Record Brackets (Code 128 / EAN 128)

Serial Cmd: <K474,status,fixed symbol length status,fixed symbol length,EAN 128 status,output format,application record separator status,application record separator character,application record brackets,application record padding,separation factor>

Default: **0 = Disabled**

Options: **0 = Disabled** 1 = Enabled

### Application Record Padding (Code 128 / EAN 128)

Serial Cmd: <K474,status,fixed symbol length status,fixed symbol length,EAN 128 status,output format,application record separator status,application record separator character,application record brackets,application record padding,separation factor>

Default: **0 = Disabled**

Options: **0 = Disabled** 1 = Enabled

### Separation Factor (Code 128 / EAN 128)

Serial Cmd: <K474,status,fixed symbol length status,fixed symbol length,EAN 128 status,output format,application record separator status,application record separator character,application record brackets,application record padding,separation factor>

Default: **0 = Normal**

Options: **0 = Normal**

1 = High

2 = Highest

**Code 93****Status (Code 93)**

Serial Cmd: <**K475,status**,fixed symbol length status,symbol length>

Default: **3 = Both Standard and Edge-to-Edge**

Options: 0 = Disabled  
 1 = Standard  
 2 = Edge-to-Edge  
**3 = Both Standard and Edge-to-Edge**

**Fixed Symbol Length Status (Code 93)**

Serial Cmd: <**K475,status**,fixed symbol length status,symbol length>

Default: **0 = Disabled**

Options: **0 = Disabled** 1 = Enabled

**Symbol Length (Code 93)**

Serial Cmd: <**K475,status**,fixed symbol length status,**symbol length**>

Default: **10**

Options: 1 to 128

**PDF417****Status (PDF417)**

Serial Cmd: <**K476,status**,unused,fixed symbol length status,fixed symbol length,unused,decode at end of read cycle>

Default: **0 = Disabled**

Options: **0 = Disabled** 1 = Enabled

**Fixed Symbol Length Status (PDF417)**

Serial Cmd: <**K476,status**,unused,fixed symbol length status,fixed symbol length,unused,decode at end of read cycle>

Default: **0 = Disabled**

Options: **0 = Disabled** 1 = Enabled

**Fixed Symbol Length (PDF417)**

Serial Cmd: <**K476,status**,unused,fixed symbol length status,fixed symbol length,unused,decode at end of read cycle>

Default: **10**

Options: 1 to 2710

**Decode at End of Read Cycle (PDF417)**

Serial Cmd: <**K476,status**,unused,fixed symbol length status,fixed symbol length,unused,**decode at end of read cycle**>

Default: **0 = Disabled**

Options: **0 = Disabled** 1 = Enabled

## Pharmacode

### Status (Pharmacode)

Serial Cmd: <**K477**,**status**,fixed symbol length status,fixed symbol length,minimum bars,bar width status,direction,fixed threshold value>

Default: **0 = Disabled**

Options: **0 = Disabled** 1 = Enabled

### Fixed Symbol Length Status (Pharmacode)

Serial Cmd: <**K477**,**status**,**fixed symbol length status**,fixed symbol length,minimum bars,bar width status,direction,fixed threshold value>

Default: **0 = Disabled**

Options: **0 = Disabled** 1 = Enabled

### Fixed Symbol Length (Pharmacode)

Serial Cmd: <**K477**,**status**,fixed symbol length status,**fixed symbol length**,minimum bars,bar width status,direction,fixed threshold value>

Default: **10**

Options: 1 to 16

### Minimum Bars (Pharmacode)

Serial Cmd: <**K477**,**status**,fixed symbol length status,fixed symbol length,**minimum bars**,bar width status,direction,fixed threshold value>

Default: **4**

Options: 1 to 16

### Bar Width Status (Pharmacode)

Serial Cmd: <**K477**,**status**,fixed symbol length status,fixed symbol length,minimum bars,**bar width status**,direction,fixed threshold value>

Default: **0 = Mixed**

Options: **0 = Mixed**

1 = All Narrow

2 = All Wide

3 = Fixed Threshold

### Direction (Pharmacode)

Serial Cmd: <**K477**,**status**,fixed symbol length status,fixed symbol length,minimum bars,bar width status,**direction**,fixed threshold value>

Default: **0 = Forward**

Options: **0 = Forward** 1 = Reverse

### Fixed Threshold Value (Pharmacode)

Serial Cmd: <**K477**,**status**,fixed symbol length status,fixed symbol length,minimum bars,bar width status,direction,**fixed threshold value**>

Default: **400**

Options: 1 to 65535

**DataBar-14 (GS1 DataBar)**

Serial Cmd: <**K482,status**>

Default: **0 = Disabled**

Options: **0 = Disabled** 1 = Enabled

**DataBar Limited (GS1 DataBar)**

Serial Cmd: <**K483,status**>

Default: **0 = Disabled**

Options: **0 = Disabled** 1 = Enabled

**DataBar Expanded (GS1 DataBar)**

Serial Cmd: <**K484,status,fixed symbol length status,fixed symbol length**>

Default: **0 = Disabled**

Options: **0 = Disabled** 1 = Enabled

**Fixed Symbol Length Status (DataBar Expanded; GS1 DataBar)**

Serial Cmd: <**K484,status,fixed symbol length status,fixed symbol length**>

Default: **0 = Disabled**

Options: **0 = Disabled** 1 = Enabled

**Fixed Symbol Length (DataBar Expanded; GS1 DataBar)**

Serial Cmd: <**K484,status,fixed symbol length status,fixed symbol length**>

Default: **14**

Options: 1 to 74

**MicroPDF417**

Serial Cmd: <**K485,status,unused,fixed symbol length status,fixed symbol length**>

Default: **0 = Disabled**

Options: **0 = Disabled** 1 = Enabled

**Fixed Symbol Length Status (MicroPDF417)**

Serial Cmd: <**K485,status,fixed symbol length status,fixed symbol length**>

Default: **0 = Disabled**

Options: **0 = Disabled** 1 = Enabled

**Fixed Symbol Length (MicroPDF417)**

Serial Cmd: <**K485,status,fixed symbol length status,fixed symbol length**>

Options: 1 to 366

---

## Serial Commands

## I/O Parameters

Calibration Options	<K529,gain,shutter speed,focus position,symbol type>window of interest framing>window of interest margin,unused>
Serial Verification	<K701,serial command echo status,serial command beep status,control/hex output>
Beeper	<K702,status>
Quality Output	<K704,quality output separator,decodes per trigger status>
Symbol Data Output	<K705,symbol data output status,when to output symbol data>
Read Duration Output	<K706,status,separator>
No Read Message	<K714,status,message>
Input 1	<K730,mode,active state>
Frame Information	<K734,output frame number,output coordinates>
ISO/IEC 16022 Parameter LED Configuration	<K737,unused,ISO/IEC 16022 parameter>
Green Flash LED	<K750,green flash LED status,targeting status,green flash duration>
Status Indicators	<K751,comm,bar graph,I/O 1,I/O 2>
EZ Trax Output	<K757,status,comm port,image mode,image format,JPEG quality,object info output,grade output>
Database Identifier Output	<K759,status,separator character>
EZ Button	<K770,global status,default on power-on,load configuration database,save for power-on>
EZ Button Modes	<K771,single beep,two beeps,three beeps,four beeps>
Trend Analysis Output 1	<K780,trend analysis mode,number of triggers,number to output on,decodes per trigger>
Trend Analysis Output 2	<K781,trend analysis mode,number of triggers,number to output on,decodes per trigger>
Trend Analysis Output 3	<K782,trend analysis mode,number of triggers,number to output on,decodes per trigger>
Diagnostics Output 1	<K790,unused,service unit>
Diagnostics Output 2	<K791,unused,service unit>
Diagnostics Output 3	<K792,unused,service unit>
Symbol Quality Output 1	<K800,output on symbol contrast,symbol contrast threshold,output on print growth,print growth threshold,output on axial non-uniformity,axial non-uniformity threshold,output on unused ECC,unused ECC threshold>
Symbol Quality Output 2	<K801,output on symbol contrast,symbol contrast threshold,output on print growth,print growth threshold,output on axial non-uniformity,axial non-uniformity threshold,output on unused ECC,unused ECC threshold>
Symbol Quality Output 3	<K802,output on symbol contrast,symbol contrast threshold,output on print growth,print growth threshold,output on axial non-uniformity,axial non-uniformity threshold,output on unused ECC,unused ECC threshold>
Output 1 Parameters	<K810,output on,output state,pulse width,output mode>
Output 2 Parameters	<K811,output on,output state,pulse width,output mode>
Output 3 Parameters	<K812,output on,output state,pulse width,output mode>



## Serial Verification

### Serial Command Echo Status (Serial Verification)

Serial Cmd: <**K701**,*serial command echo status*,*serial command beep status*,*control/hex output*>

Default: **0 = Disabled**

Options: **0 = Disabled**      1 = Enabled

### Serial Command Beep Status (Serial Verification)

Serial Cmd: <**K701**,*serial command echo status*,***serial command beep status***,*control/hex output*>

Default: **0 = Disabled**

Options: **0 = Disabled**      1 = Enabled

### Control/Hex Output (Serial Verification)

Serial Cmd: <**K701**,*serial command echo status*,*serial command beep status*,***control/hex output***>

Default: **0 = Control**

Options: **0 = Control**      1 = Hex

## Beeper

Serial Cmd: <**K702**,***beeper status***>

Default: **1 = Good Read**

Options: 0 = Disabled      **1 = Good Read**      2 = No Read

## Quality Output

### Separator (Quality Output)

Serial Cmd: <**K704**,***separator***,*decodes per trigger status*>

Default: **, (comma)**

Options: Any 7-bit ASCII character

### Decodes per Trigger Status (Quality Output)

Serial Cmd: <**K704**,*separator*,***decodes per trigger status***>

Default: **0 = Disabled**

Options: **0 = Disabled**      1 = Enabled

## Symbol Data Output

### Symbol Data Output Status (Symbol Data Output)

Serial Cmd: <K705,**symbol data output status**,when to output,symbology i.d. output status>

Default: **3 = Good Read**

Options: 0 = Disabled                      1 = Match                      2 = Mismatch  
**3 = Good Read**

### When to Output Symbol Data (Symbol Data Output)

Serial Cmd: <K705,symbol data output status,**when to output**,symbology i.d. output status>

Default: **0 = As Soon As Possible**

Options: **0 = ASAP**                      1 = End of Read Cycle

### Symbology ID Output Status (Symbol Data Output)

Serial Cmd: <K705,symbol data output status,when to output,**symbology ID output status**>

Default: **0 = Disabled**

Options: **0 = Disabled**                      1 = Enabled (AIM-Defined ID)                      2 = Readable ID

## Read Duration Output

### Read Duration Output Status (Read Duration Output)

Serial Cmd: <K706,**status**,separator>

Default: **0 = Disabled**

Options: **0 = Disabled**                      1 = Enabled

### Read Duration Output Separator (Read Duration Output)

Serial Cmd: <K706,status,**separator**>

Default: **Space (0x20)**

Options: Any 7-bit ASCII character

## No Read Message

### No Read Message Status (No Read Message)

Serial Cmd: <K714,**No Read message status**,No Read message>

Default: **1 = Enabled**

Options: 0 = Disabled                      **1 = Enabled**

### No Read Message (No Read Message)

Serial Cmd: <K714,no read message status,**No Read message**>

Default: **NOREAD**

Options: Any valid ASCII string up to 128 characters

## Input 1

### Status (Input 1)

Serial Cmd: <K730,**status**,active state>

Default: **0 = Disabled**

Options: **0 = Disabled**  
 1 = Reset Counts  
 2 = Unlatch Output

### Active State (Input 1)

Serial Cmd: <K730,**status**,**active state**>

Default: **0 = Active Open**

Options: **0 = Active Open**            1 = Active Closed

## Green Flash LED (Standard QX Hawk Only)

### Green Flash Mode (Green Flash LED)

Serial Cmd: <K750,**green flash mode**,unused,**green flash duration**>

Default: **1 = Good Read**

Options: 0 = Disabled  
**1 = Good Read**  
 2 = Static Presentation  
 3 = Match  
 4 = Mismatch  
 5 = Strobe

### Green Flash Duration (Green Flash LED)

Serial Cmd: <K750,**green flash mode**,unused,**green flash duration**>

Default: **100 (1 second)**

Options: 0 to 65535 (in 10 ms increments)

## Status Indicators

### Status (Status Indicators)

Serial Cmd: <K751,**status**,bar graph,I/O 1,I/O 2>

Default: **1 = PHY Activity**

Options: 0 = Disabled  
**1 = PHY Activity**  
 2 = Protocol Activity

### Bar Graph (Status Indicators)

Serial Cmd: <K751,**status**,**bar graph**,I/O 1,I/O 2>

Default: **1 = Read Rate / Good Read**

Options: 0 = Disabled  
**1 = Read Rate / Good Read**  
 2 = Symbol Grade

---

## Serial Commands

### I/O 1 (Status Indicators)

Serial Cmd: <**K751**,*status,bar graph,I/O 1,I/O 2*>

Default: **1 = Output Active**

Options: 0 = Disabled

**1 = Output Active**

2 = Input Active

### I/O 2 (Status Indicators)

Serial Cmd: <**K751**,*status,bar graph,I/O 1,I/O 2*>

Default: **2 = Input Active**

Options: 0 = Disabled

1 = Output Active

**2 = Input Active**

## Database Identifier Output

### Status (Database Identifier Output)

Serial Cmd: <**K759**,*status,separator*>

Default: **0 = Disabled**

Options: **0 = Disabled** 1 = Enabled

### Separator (Database Identifier Output)

Serial Cmd: <**K759**,*status,separator*>

Default: **Space (0x20)**

Options: Any 7-bit ASCII character

## EZ Button

### Global Status (EZ Button)

Serial Cmd: <**K770**,*global status,default on power-on*>

Default: **1 = Enabled**

Options: 0 = Disabled

**1 = Enabled**

2 = Trigger

3 = Unlatch Outputs

4 = Parameter Switch

### Default on Power-On (EZ Button)

Serial Cmd: <**K770**,*global status,default on power-on*>

Default: **1 = Enabled**

Options: 0 = Disabled

**1 = Enabled**

**EZ Button Modes (Standard QX Hawk)**

Serial Cmd: <**K771**,one beep,two beeps,three beeps,four beeps>

Options: 0 = Disabled 1 = Enabled

One Beep	Two Beeps	Three Beeps	Four Beeps
0 = Disabled	0 = Disabled	0 = Disabled	0 = Disabled
1 = Read Rate	1 = Read Rate	<b>1 = Read Rate</b>	1 = Read Rate
2 = Calibrate	<b>2 = Calibrate</b>	2 = Calibrate	2 = Calibrate
3 = Save for Power-On	3 = Save for Power-On	3 = Save for Power-On	<b>3 = Save for Power-On</b>
4 = Unused	4 = Unused	4 = Unused	4 = Unused
5 = Load New Master	5 = Load New Master	5 = Load New Master	5 = Load New Master
6 = Unused	6 = Unused	6 = Unused	6 = Unused
<b>7 = Target System</b>	7 = Target System	7 = Target System	7 = Target System
8 = Unused	8 = Unused	8 = Unused	8 = Unused
9 = Bar Code Config.	9 = Bar Code Config.	9 = Bar Code Config.	9 = Bar Code Config.

**EZ Button Modes (QX Hawk C-Mount)**

Serial Cmd: <**K771**,one beep,two beeps,three beeps,four beeps>

Options: 0 = Disabled 1 = Enabled

One Beep	Two Beeps	Three Beeps	Four Beeps
0 = Disabled	0 = Disabled	0 = Disabled	0 = Disabled
<b>1 = Read Rate</b>	1 = Read Rate	1 = Read Rate	1 = Read Rate
2 = Calibrate	<b>2 = Calibrate</b>	2 = Calibrate	2 = Calibrate
3 = Save for Power-On	3 = Save for Power-On	3 = Save for Power-On	<b>3 = Save for Power-On</b>
4 = Unused	4 = Unused	4 = Unused	4 = Unused
5 = Load New Master	5 = Load New Master	<b>5 = Load New Master</b>	5 = Load New Master
6 = Unused	6 = Unused	6 = Unused	6 = Unused
7 = Unused	7 = Unused	7 = Unused	7 = Unused
8 = Unused	8 = Unused	8 = Unused	8 = Unused
9 = Bar Code Config.	9 = Bar Code Config.	9 = Bar Code Config.	9 = Bar Code Config.

**Trend Analysis Output 1****Trend Analysis Mode (Trend Analysis Output 1)**

Serial Cmd: <**K780**,trend analysis mode,trigger evaluation period,number to output on,decodes per trigger threshold>

Default: **1 = No Read**

Options: 0 = Mismatch  
**1 = No Read**  
 2 = Decodes per Trigger

---

## Serial Commands

### Trigger Evaluation Period (Trend Analysis Output 1)

Serial Cmd: <K780,trend analysis mode,trigger evaluation period,number to output on,decodes per trigger threshold>

Default: 0

Options: 0 to 255

### Number to Output On (Trend Analysis Output 1)

Serial Cmd: <K780,trend analysis mode,trigger evaluation period,number to output on,decodes per trigger threshold>

Default: 0

Options: 0 to 255

### Decodes per Trigger Threshold (Trend Analysis Output 1)

Serial Cmd: <K780,trend analysis mode,trigger evaluation period,number to output on,decodes per trigger threshold>

Default: 0

Options: 0 to 65535

### Trend Analysis Output 2

Serial Cmd: <K781,trend analysis mode,trigger evaluation period,number to output on>

### Trend Analysis Output 3

Serial Cmd: <K782,trend analysis mode,trigger evaluation period,number to output on>

### Diagnostics Output 1

#### Service Unit (Diagnostics Output 1)

Serial Cmd: <K790,service unit>

Default: 0 = Disabled

Options: 0 = Disabled 1 = Enabled

### Diagnostics Output 2

Serial Cmd: <K791,service unit>

### Diagnostics Output 3

Serial Cmd: <K792,service unit>

## Output 1 Parameters

### Output On (Output 1 Parameters)

Serial Cmd: <K810,output on,output state,pulse width,output mode>

Default: **Mismatch or No Read**

Options: **0 = Mismatch or No Read**

1 = Match or Good Read

2 = Mismatch

3 = No Read

4 = Trend Analysis

5 = Symbol Quality

6 = Diagnostic Warning

7 = In Read Cycle

### Output State (Output 1 Parameters)

Serial Cmd: <K810,output on,output state,pulse width,output mode>

Default: **0 = Normally Open**

Options: **0 = Normally Open**      1 = Normally Closed

### Pulse Width (Output 1 Parameters)

Serial Cmd: <K810,output on,output state,pulse width,output mode>

Default: **500**

Options: 1 to 65535 (in 1 ms increments)

### Output Mode (Output 1 Parameters)

Serial Cmd: <K810,output on,output state,pulse width,output mode>

Default: **0 = Pulse**

Options: **0 = Pulse**

1 = Latch Mode 1 (Unlatch Input 1 Pin)

2 = Latch Mode 2 (Unlatch Opposite Condition)

3 = Latch Mode 3 (Unlatch Re-Enter Read Cycle)

## Output 2 Parameters

Serial Cmd: <K811,output on,output state,pulse width,output mode>

## Output 3 Parameters

Serial Cmd: <K812,output on,output state,pulse width,output mode>

---

## Serial Commands

### Matchcode

Matchcode	< <b>K223</b> ,matchcode type,sequential matching,match start position,match length,wild card,sequence on no read,sequence on mismatch>
Master Symbol Database Size	< <b>K224</b> ,number of master symbols>
New Master Pin	< <b>K225</b> ,status>
Un-Delimited Serial Start Character	< <b>K229</b> ,start character value>
Un-Delimited Serial Stop Character	< <b>K230</b> ,stop character value>
Master Symbol	< <b>K231</b> ,index,master symbol data>
Match Replace	< <b>K735</b> ,status,replacement string>
Mismatch Replace	< <b>K736</b> ,status,replacement string>

### Matchcode

#### Matchcode Type (Matchcode)

*Serial Cmd:* <**K223**,**matchcode type**,sequential matching,match start position,match length,wild card character,sequence on No Read,sequence on mismatch>

*Default:* **0 = Disabled**

*Options:* **0 = Disabled**  
1 = Enabled  
2 = Wild Card  
3 = Sequential

#### Sequential Matching (Matchcode)

*Serial Cmd:* <**K223**,matchcode type,**sequential matching**,match start position,match length,wild card character,sequence on No Read,sequence on mismatch>

*Default:* **0 = Increment**

*Options:* **0 = Increment**                      1 = Decrement

#### Match Start Position (Matchcode)

*Serial Cmd:* <**K223**,matchcode type,sequential matching,**match start position**,match length,wild card character,sequence on No Read,sequence on mismatch>

*Default:* **0**

*Options:* 0 to 3000

#### Match Length (Matchcode)

*Serial Cmd:* <**K223**,matchcode type,sequential matching,match start position,**match length**,wild card character,sequence on No Read,sequence on mismatch>

*Default:* **1**

*Options:* 1 to 3000



**Wild Card Character (Matchcode)**

Serial Cmd: <K223,matchcode type,sequential matching,match start position,match length,wild card character,sequence on No Read,sequence on mismatch>

Default: \* (asterisk)

Options: Any 7-bit ASCII character

**Sequence on No Read (Matchcode)**

Serial Cmd: <K223,matchcode type,sequential matching,match start position,match length,wild card character,sequence on No Read,sequence on mismatch>

Default: 1 = Enabled

Options: 0 = Disabled 1 = Enabled

**Sequence on Mismatch (Matchcode)**

Serial Cmd: <K223,matchcode type,sequential matching,match start position,match length,wild card character,sequence on No Read,sequence on mismatch>

Default: 0 = Disabled

Options: 0 = Disabled 1 = Enabled

**Master Symbol Database Size**

Serial Cmd: <K224,number of master symbols>

Default: 1

Options: 1 to 10

**New Master Pin**

Serial Cmd: <K225,status>

Default: 0 = Disabled

Options: 0 = Disabled 1 = Enabled

**Master Symbol****Index (Master Symbol)**

Serial Cmd: <K231,index,master symbol data>

Options: 1 to 32768

**Master Symbol Data (Master Symbol)**

Serial Cmd: <K231,index,master symbol data>

Options: Any valid ASCII string

### **Match Replace**

#### **Status (Match Replace)**

*Serial Cmd:* <**K735**,*status*,*replacement string*>

*Default:* **0 = Disabled**

*Options:* **0 = Disabled** 1 = Enabled

#### **Replacement String (Match Replace)**

*Serial Cmd:* <**K735**,*status*,*replacement string*>

*Default:* **MATCH**

*Options:* Any valid ASCII string up to 128 characters

### **Mismatch Replace**

#### **Status (Mismatch Replace)**

*Serial Cmd:* <**K736**,*status*,*replacement string*>

*Default:* **0 = Disabled**

*Options:* **0 = Disabled** 1 = Enabled

#### **Replacement String (Mismatch Replace)**

*Serial Cmd:* <**K736**,*status*,*replacement string*>

*Default:* **MISMATCH**

*Options:* Any valid ASCII string up to 128 characters

## Diagnostics

Time Since Reset (Read-only)	<K407,hours,minutes> (returns: hours,minutes)
Service Message	<K409,status,service message,threshold,resolution>
User-Defined Name	<K412,user-defined name>

### Time Since Reset (Read-only)

#### Hours (Time Since Reset)

Serial Cmd: <K407,hours,minutes>  
16-bit counter (0 to 65535)

#### Minutes (Time Since Reset)

Serial Cmd: <K407,hours,minutes>  
16-bit counter (0 to 60)

## Service Message

### Status (Service Message)

Serial Cmd: <K409,status,service message,threshold,resolution>  
Default: **0 = Disabled**  
Options: **0 = Disabled**                      1 = Enabled

### Service Message (Service Message)

Serial Cmd: <K409,status,service message,threshold,resolution>  
Default: **SERVICE**  
Options: Any valid ASCII string up to 128 characters

### Threshold (Service Message)

Serial Cmd: <K409,status,service message,threshold,resolution>  
Default: **300 (5 minutes)**  
Options: 1 to 65535

### Resolution (Service Message)

Serial Cmd: <K409,status,service message,threshold,resolution>  
Default: **0 = Seconds**  
Options: **0 = Seconds**                      1 = Minutes

## User-Defined Name

Serial Cmd: <K412,user-defined name>  
Default: **QX Hawk**  
Options: Any valid ASCII string up to 50 characters

---

## Serial Commands

### Camera Setup

Window of Interest	< <b>K516</b> , <i>row pointer,column pointer,row depth,column width</i> >
Focus Distance	< <b>K525</b> , <i>focal distance,distance units,lens type</i> >
Illumination (Standard QX Hawk Only)	< <b>K539</b> , <i>mode,intensity</i> >
Camera Settings	< <b>K541</b> , <i>shutter speed,gain</i> >
Sub-Sampling	< <b>K542</b> , <i>sub-sampling</i> >
Morphological Pre-Processing	< <b>K550</b> , <i>status</i> >
Morphological Operations	< <b>K551</b> , <i>unused,operation,size</i> >
External Illumination Mode	< <b>K553</b> , <i>mode</i> >

### Window of Interest (CMOS)

#### Row Pointer (Window of Interest)

Serial Cmd: <**K516**,*row pointer,column pointer,row depth,column width*>

Default: **0**

Options: 0 to (480 – row depth)

#### Column Pointer (Window of Interest)

Serial Cmd: <**K516**,*row pointer,column pointer,row depth,column width*>

Default: **0**

Options: 0 to (752 – column width)

#### Row Depth (Window of Interest)

Serial Cmd: <**K516**,*row pointer,column pointer,row depth,column width*>

Default: **480**

Options: 3 to (480 – row pointer)

#### Column Width (Window of Interest)

Serial Cmd: <**K516**,*row pointer,column pointer,row depth,column width*>

Default: **752**

Options: 8 to (752 – column pointer)

### Window of Interest (CCD)

#### Row Pointer (Window of Interest)

Serial Cmd: <**K516**,*row pointer,column pointer,row depth,column width*>

Default: **0**

Options: 0 to (960 – row depth)

#### Column Pointer (Window of Interest)

Serial Cmd: <**K516**,*row pointer,column pointer,row depth,column width*>

Default: **0**

Options: 0 to (1280 – column width)

**Row Depth (Window of Interest)**

Serial Cmd: <**K516**,row pointer,column pointer,**row depth**,column width>

Default: **960**

Options: 3 to (960 – row pointer)

**Column Width (Window of Interest)**

Serial Cmd: <**K516**,row pointer,column pointer,row depth,**column width**>

Default: **1280**

Options: 8 to (1280 – column pointer)

**Focus Distance****Focal Distance (Focus Distance)**

Serial Cmd: <**K525**,**focal distance**,distance units,lens type>

Default: **80**

Options: 25 to 4,000 (mm)  
100 to 4,000 (1/100 inch)

**Distance Units (Focus Distance)**

Serial Cmd: <**K525**,focal distance,**distance units**,lens type>

Default: **0 = millimeters**

Options: **0 = millimeters**                      1 = 1/100 inch

**Lens Type (Focus Distance)**

Serial Cmd: <**K525**,focal distance,distance units,**lens type**>

Default: **3 = 45°**

Options: 1 = 15°  
2 = 30°  
**3 = 45°**  
4 = 12°

**Illumination (Standard QX Hawk)****Mode (Illumination, Standard QX Hawk)**

Serial Cmd: <**K539**,**mode**,intensity>

Default: **1 = Bright Field**

Options: 0 = Always Off  
**1 = Bright Field**  
2 = Mode 2  
3 = Mode 3  
4 = Mode 4 (Internal Off)

---

## Serial Commands

### Intensity (Illumination, Standard QX Hawk)

Serial Cmd: <K539,mode,*intensity*>

Default: **2 = High**

Options: 0 = Low 1 = Medium **2 = High**

### Camera Settings (CMOS)

#### Shutter Speed (Camera Settings, CMOS)

Serial Cmd: <K541,*shutter speed*,gain>

Default: **2,500**

Options: 60 to 40,000

#### Gain (Camera Settings, CMOS)

Serial Cmd: <K541,*shutter speed*,*gain*>

Default: **20**

Options: 0 to 33

### Camera Settings (CCD)

#### Shutter Speed (Camera Settings, CCD)

Serial Cmd: <K541,*shutter speed*,gain>

Default: **1,500**

Options: 30 to 150,000

#### Gain (Camera Settings, CCD)

Serial Cmd: <K541,*shutter speed*,*gain*>

Default: **20**

Options: 0 to 64

### Sub-Sampling

Serial Cmd: <K542,*sub-sampling*>

Default: **0 = Disabled**

Options: **0 = Disabled** 1 = 4:1 2 = 16:1

### Morphological Pre-Processing

Serial Cmd: <K550,*status*>

Default: **0 = Disable**

Options: **0 = Disable** 1 = Enable

## ***Morphological Operations***

### **Operation (Morphological Operations)**

*Serial Cmd:* <**K551**,unused,**operation**,size>

*Default:*       **0 = Erode**

*Options:*       **0 = Erode**                   1 = Dilate                   2 = Open  
                  3 = Close

### **Size (Morphological Operations)**

*Serial Cmd:* <**K551**,unused,**operation**,**size**>

*Default:*       **3 = Small**

*Options:*       **3 = Small**                   5 = Medium                   7 = Large

## ***External Illumination Mode***

### **Mode (External Illumination Mode)**

*Serial Cmd:* <**K553**,**mode**>

*Default:*       **0 = No External Illumination Control**

*Options:*       **0 = No External Illumination Control**

                  1 = Always ON

                  2 = Always OFF

                  3 = Always ON During Read Cycle

---

## Serial Commands

### Configuration Database

Number of Active Indexes	< <b>K252</b> , <i>number of active indexes,sort database</i> >
Configuration Database (CMOS)	< <b>K255</b> , <i>index,shutter speed,gain,focal distance,sub-sampling,row pointer,column pointer,row depth,column width,symbol type,morphology operation,morphology size</i> >
Configuration Database (CCD)	< <b>K255</b> , <i>index,shutter speed,gain,focal distance,unused,row pointer,column pointer,row depth,column width,symbol type,morphology operation,morphology size</i> >
Save Current Settings to Configuration Database	< <b>K255+</b> , <i>index</i> >
Load Current Settings from Configuration Database	< <b>K255-</b> , <i>index</i> >
Request Database Index Setting	< <b>K255?</b> , <i>index</i> >
Request All Database Settings	< <b>K255?</b> >
Database Mode	< <b>K256</b> , <i>switch mode,frame count/time,image process looping,image dimensions</i> >

### Number of Active Indexes

Serial Cmd: <**K252**,*number of active indexes,sort database*>

Default: **0 = Disabled**

Options: 0 to 10

### Sort Database (Number of Active Indexes)

Serial Cmd: <**K252**,*number of active indexes,sort database*>

Default: **0 = Disabled**

Options: **0 = Disabled**

1 = Enabled

### Configuration Database (Standard QX Hawk, CMOS)

#### Index (Configuration Database, Standard QX Hawk, CMOS)

Serial Cmd: <**K255**,*index,shutter speed,gain,focal distance,sub-sampling,row pointer,column pointer,row depth,column width,symbol type,morphology operation,morphology size*>

Options: 1 to 10

#### Shutter Speed (Configuration Database, Standard QX Hawk, CMOS)

Serial Cmd: <**K255**,*index,shutter speed,gain,focal distance,sub-sampling,row pointer,column pointer,row depth,column width,symbol type,morphology operation,morphology size*>

Default: **2,500**

Options: 60 to 40,000



**Gain (Configuration Database, Standard QX Hawk, CMOS)**

*Serial Cmd:* <**K255**,index,shutter speed,**gain**,focal distance,sub-sampling,row pointer,column pointer,row depth,column width,symbol type,morphology operation,morphology size>

*Default:* **20**

*Options:* 0 to 33

**Focal Distance (Configuration Database, Standard QX Hawk, CMOS)**

*Serial Cmd:* <**K255**,index,shutter speed,gain,**focal distance**,sub-sampling,row pointer,column pointer,row depth,column width,symbol type,morphology operation,morphology size>

*Default:* **80**

*Options:* 25 to 4,000

**Sub-Sampling (Configuration Database, Standard QX Hawk, CMOS)**

*Serial Cmd:* <**K255**,index,shutter speed,gain,focal distance,**sub-sampling**,row pointer,column pointer,row depth,column width,symbol type,morphology operation,morphology size>

*Default:* **0 = Disabled**

*Options:* **0 = Disabled**                      1 = 4:1                      2 = 16:1

**Row Pointer (Configuration Database, Standard QX Hawk, CMOS)**

*Serial Cmd:* <**K255**,index,shutter speed,gain,focal distance,sub-sampling,**row pointer**,column pointer,row depth,column width,symbol type,morphology operation,morphology size>

*Default:* **0**

*Options:* 0 to (480 – row depth)

**Column Pointer (Configuration Database, Standard QX Hawk, CMOS)**

*Serial Cmd:* <**K255**,index,shutter speed,gain,focal distance,sub-sampling,row pointer,**column pointer**,row depth,column width,symbol type,morphology operation,morphology size>

*Default:* **0**

*Options:* 0 to (752 – column width)

**Row Depth (Configuration Database, Standard QX Hawk, CMOS)**

*Serial Cmd:* <**K255**,index,shutter speed,gain,focal distance,sub-sampling,row pointer,column pointer,**row depth**,column width,symbol type,morphology operation,morphology size>

*Default:* **480**

*Options:* 3 to (480 – row pointer)

---

## Serial Commands

### Column Width (Configuration Database, Standard QX Hawk, CMOS)

*Serial Cmd:* <**K255**,index,shutter speed,gain,focal distance,sub-sampling,row pointer,column pointer,row depth,**column width**,symbol type,morphology operation,morphology size>

*Default:* **752**

*Options:* 8 to (752 – column pointer)

### Symbol Type (Configuration Database, Standard QX Hawk, CMOS)

*Serial Cmd:* <**K255**,index,shutter speed,gain,focal distance,sub-sampling,row pointer,column pointer,row depth,column width,**symbol type**,morphology operation,morphology size>

*Default:* **0 = Disabled**

*Options:* **0 = Disabled**

Any Type (except Pharmacode): Add **1**

Data Matrix: Add **2**

QR Code: Add **4**

Code 128: Add **8**

Code 39: Add **16**

Codabar: Add **32**

Code 93: Add **64**

Interleaved 2 of 5: Add **128**

UPC: Add **256**

PDF417: Add **512**

Micro PDF: Add **1024**

BC412: Add **2048**

Pharmacode: Add **4096**

DataBar-14: Add **8192**

DataBar Limited: Add **16384**

DataBar Extended: Add **32768**

MicroQR Code: Add **65536**

Aztec: Add **131072**

Current Postal Code: Add **262144**

### Morphology Operation (Configuration Database, Standard QX Hawk, CMOS)

*Serial Cmd:* <**K255**,index,shutter speed,gain,focal distance,sub-sampling,row pointer,column pointer,row depth,column width,symbol type,**morphology operation**,morphology size>

*Default:* **0 = Disable**

*Options:* **0 = Disable**

1 = Erode

2 = Dilate

3 = Open

4 = Close

**Morphology Size (Configuration Database, Standard QX Hawk, CMOS)**

Serial Cmd: <K255,index,shutter speed,gain,focal distance,sub-sampling,row pointer,column pointer,row depth,column width,symbol type,morphology operation,morphology size>

Default: **3 = Small**

Options: **3 = Small**                      5 = Medium                      7 = Large

**Configuration Database (Standard QX Hawk, CCD)****Index (Configuration Database, Standard QX Hawk, CCD)**

Serial Cmd: <K255,index,shutter speed,gain,focal distance,unused,row pointer,column pointer,row depth,column width,symbol type,morphology operation,morphology size>

Options: 1 to 10

**Shutter Speed (Configuration Database, Standard QX Hawk, CCD)**

Serial Cmd: <K255,index,shutter speed,gain,focal distance,unused,row pointer,column pointer,row depth,column width,symbol type,morphology operation,morphology size>

Default: **1,500**

Options: 30 to 150,000

**Gain (Configuration Database, Standard QX Hawk, CCD)**

Serial Cmd: <K255,index,shutter speed,gain,focal distance,unused,row pointer,column pointer,row depth,column width,symbol type,morphology operation,morphology size>

Default: **20**

Options: 0 to 64

**Focal Distance (Configuration Database, Standard QX Hawk, CCD)**

Serial Cmd: <K255,index,shutter speed,gain,focal distance,unused,row pointer,column pointer,row depth,column width,symbol type,morphology operation,morphology size>

Default: **80**

Options: 25 to 4,000

**Row Pointer (Configuration Database, Standard QX Hawk, CCD)**

Serial Cmd: <K255,index,shutter speed,gain,focal distance,unused,row pointer,column pointer,row depth,column width,symbol type,morphology operation,morphology size>

Default: **0**

Options: 0 to (480 – row depth)

---

## Serial Commands

### Column Pointer (Configuration Database, Standard QX Hawk, CCD)

Serial Cmd: <**K255**,index,shutter speed,gain,focal distance,unused,row pointer,**column pointer**,row depth,column width,symbol type,morphology operation,morphology size>

Default: **0**

Options: 0 to (752 – column width)

### Row Depth (Configuration Database, Standard QX Hawk, CCD)

Serial Cmd: <**K255**,index,shutter speed,gain,focal distance,unused,row pointer,column pointer,**row depth**,column width,symbol type,morphology operation,morphology size>

Default: **480**

Options: 3 to (480 – row pointer)

### Column Width (Configuration Database, Standard QX Hawk, CCD)

Serial Cmd: <**K255**,index,shutter speed,gain,focal distance,unused,row pointer,column pointer,row depth,**column width**,symbol type,morphology operation,morphology size>

Default: **752**

Options: 8 to (752 – column pointer)

### Symbol Type (Configuration Database, Standard QX Hawk, CCD)

Serial Cmd: <**K255**,index,shutter speed,gain,focal distance,unused,row pointer,column pointer,row depth,column width,**symbol type**,morphology operation,morphology size>

Default: **0 = Disabled**

Options: **0 = Disabled**

Any Type (except Pharmacode): Add **1**

Data Matrix: Add **2**

QR Code: Add **4**

Code 128: Add **8**

Code 39: Add **16**

Codabar: Add **32**

Code 93: Add **64**

Interleaved 2 of 5: Add **128**

UPC: Add **256**

PDF417: Add **512**

Micro PDF: Add **1024**

BC412: Add **2048**

Pharmacode: Add **4096**

DataBar-14: Add **8192**

DataBar Limited: Add **16384**

DataBar Extended: Add **32768**

MicroQR Code: Add **65536**

Aztec: Add **131072**

Current Postal Code: Add **262144**

**Morphology Operation (Configuration Database, Standard QX Hawk, CCD)**

*Serial Cmd:* <K255,index,shutter speed,gain,focal distance,unused,row pointer,column pointer,row depth,column width,symbol type,**morphology operation**,morphology size>

*Default:* **0 = Disable**

*Options:* **0 = Disable**                      1 = Erode                      2 = Dilate  
                   3 = Open                              4 = Close

**Morphology Size (Configuration Database, Standard QX Hawk, CCD)**

*Serial Cmd:* <K255,index,shutter speed,gain,focal distance,unused,row pointer,column pointer,row depth,column width,symbol type,**morphology operation**,**morphology size**>

*Default:* **3 = Small**

*Options:* **3 = Small**                      5 = Medium                      7 = Large

**Save Current Settings to Configuration Database**

*Serial Cmd:* <K255+,index>

*Example:* <K255+,5> Saves current imager settings to database index number 5.

**Load Current Settings from Configuration Database**

*Serial Cmd:* <K255-,index>

*Example:* <K255-,5> Loads current settings from database index number 5 to the imager.

**Request Database Index Setting**

*Serial Cmd:* <K255?,index>

*Returns:* Returns settings for the selected Configuration Database index.

**Request All Database Settings**

*Serial Cmd:* <K255?>

*Returns:* Returns settings for the entire Configuration Database.

**Database Mode****Switch Mode (Database Mode)**

*Serial Cmd:* <K256,**switch mode**,frame count/time,image process looping,image dimensions>

*Default:* **1 = Number of Image Frames**

*Options:* 0 = Time  
**1 = Number of Image Frames**

**Frame Count/Time (Database Mode)**

*Serial Cmd:* <K256,switch mode,**frame count/time**,image process looping,image dimensions>

*Default:* **1 (1 frame/1 ms)**

*Options:* 1 to 65535 (in 1 ms increments)

---

*Serial Commands*

**Image Process Looping (Database Mode)**

*Serial Cmd:* <**K256**,switch mode,frame count/time,**image process looping**,image dimensions>

*Default:*       **0 = Disabled**

*Options:*       **0 = Disabled**                   1 = Enabled

**Image Dimensions (Database Mode)**

*Serial Cmd:* <**K256**,switch mode,frame count/time,image process looping,**image dimensions**>

*Default:*       **0 = Window of Interest**

*Options:*       **0 = Window of Interest**       1 = Region of Interest

## Output Format

Format Extract	< <b>K740</b> ,output index,start location,length>
Format Insert	< <b>K741</b> ,output index,length,hex string>
Format Assign	< <b>K742</b> ,symbol number,status>
Output Format Status	< <b>K743</b> ,output format status>
Output Filter Configuration	< <b>K744</b> ,filter number,symbology type,length,wildcard,placeholder,data,unused,database index>
Number of Filters	< <b>K745</b> ,number of filters>

### Format Extract

#### Output Index (Format Extract)

*Serial Cmd:* <**K740**,output index,start location,length>

*Options:* 1 to 100

#### Start Location (Format Extract)

*Serial Cmd:* <**K740**,output index,**start location**,length>

*Default:* **0**

*Options:* 1 to *n* (maximum number of characters in the symbol data).

#### Length (Format Extract)

*Serial Cmd:* <**K740**,output index,start location,**length**>

*Default:* **0 (Disabled; end of format cell array)**

*Options:* 1 to *n* (maximum number of characters in the symbol data).

### Format Insert

#### Output Index (Format Insert)

**Output Index** refers to the database entry to be modified with this command. A formatted output is built by extracting data from a symbol's original data output and/or inserting user-defined characters.

It may be helpful to think of individual indexes as positions in the final formatted output. Starting with index # 1, enter either an extract or insert command to begin building the required output string. Then, with the next index number, enter either an extract or insert command to continue building the output string. Continue this process until the string is complete.

*Serial Cmd:* <**K741**,output index,length,hex string>

*Options:* 1 to 100

---

## Serial Commands

### Length (Format Insert)

Specifies the length of the user-defined character string that will be inserted. This function is limited to 4 characters per output index, so multiple indexes must be entered in order to insert longer character sequences.

For example, to insert a 10-character sequence in user-defined output, three commands with consecutive index numbers would be required, where the first two character sequence lengths were 4 and the third was 2.

*Serial Cmd:* <**K741**,output index,**length**,hex string>

*Default:*     **0 (Disabled; end of format cell array)**

*Options:*     1 to 4

### Hex String (Format Insert)

Specifies a character string that represents ASCII characters to be inserted in the database entry. Two hex characters are required for every ASCII character to be inserted in the user-defined output string. These two characters comprise the hex (base 16) value of the ASCII character.

For example, to enter the three-character sequence "Hi!", **3** would indicate the length of the string, and a hex sequence of **486921** would be the ASCII sequence to be inserted. (48 = H; 69 = i; 21 = !)

**Important:** Each pair of hex characters represents one ASCII character. Hex character pairs range from 00 to FF. Since there is a limit of 4 ASCII characters per insertion per database entry, there is a limit of 8 hex characters per insertion per database entry.

*Serial Cmd:* <**K741**,output index,**length**,**hex string**>

*Default:*     **NULL (0x00)**

*Options:*     00 to FF (As many as 4 bytes, or hex pairs.)

### Format Assign

#### Symbol Number (Format Assign)

*Serial Cmd:* <**K742**,**symbol number**,**status**>

*Options:*     1 to 10

1 = Formatted output status for symbol # 1.

2 = Formatted output status for symbol # 2.

...

...

10 = Formatted output status for symbol # 10.

#### Status (Format Assign)

*Serial Cmd:* <**K742**,**symbol number**,**status**>

*Default:*     **0 = Disabled**

*Options:*     **0 = Disabled**

1 = Enabled (Assign parameters to specified symbol.)



## Output Format Status

Serial Cmd: <**K743**, **output format status**>

Default: **0 = Disabled**

Options: **0 = Disabled**  
1 = Enabled

## Output Filter Configuration

### Filter Number (Output Filter Configuration)

Serial Cmd: <**K744**, **filter number**,  *symbology type, length, wildcard, placeholder, data, decode direction, database index*>

Options: 1 to 10

### Symbology Type (Output Filter Configuration)

Serial Cmd: <**K744**,  *filter number,* **symbology type**,  *length, wildcard, placeholder, data, decode direction, database index*>

Default: **0**

Options: **0 = Any type**  
1 = Interleaved 2 of 5  
2 = Code 39  
3 = Code 128  
4 = Codabar  
5 = UPC  
6 = PDF417  
7 = EAN 128  
8 = Code 93  
9 = Pharmacode  
10 = GS1 DataBar  
11 = MicroPDF417  
12 = Composite  
13 = BC412  
14 = Data Matrix  
15 = QR Code

### Length (Output Filter Configuration)

Serial Cmd: <**K744**,  *filter number, symbology type,* **length**,  *wildcard, placeholder, data, decode direction, database index*>

Default: **0**

Options: 0 to 128

---

## Serial Commands

### Wildcard (Output Filter Configuration)

*Serial Cmd:* <**K744**,*filter number,symbology type,length,wildcard,placeholder,data,decode direction,database index*>

*Default:*     **\* = (0x2A)**

*Options:*     Any ASCII input in the form of a pair of hex characters

### Placeholder (Output Filter Configuration)

*Serial Cmd:* <**K744**,*filter number,symbology type,length,wildcard,placeholder,data,decode direction,database index*>

*Default:*     **? = (0x3F)**

*Options:*     Any ASCII input in the form of a pair of hex characters

### Data (Output Filter Configuration)

*Serial Cmd:* <**K744**,*filter number,symbology type,length,wildcard,placeholder,data,decode direction,database index*>

*Default:*     **NULL (0x00)**

*Options:*     Any ASCII input in the form of a pair of hex characters

### Decode Direction (Output Filter Configuration)

*Serial Cmd:* <**K744**,*filter number,symbology type,length,wildcard,placeholder,data,decode direction,database index*>

*Default:*     **0 = Any Direction**

*Options:*     **0 = Any Direction**

              1 = Forward

              2 = Reverse

### Database Index (Output Filter Configuration)

*Serial Cmd:* <**K744**,*filter number,symbology type,length,wildcard,placeholder,data,decode direction,database index*>

*Default:*     **0** (any index)

*Options:*     0 to 10

### Number of Filters

*Serial Cmd:* <**K745**,*number of filters*>

*Default:*     **0**

*Options:*     0 to 10

## Serial Utility Commands

Type	Command	Name
Bar Code Configuration	<BCCFG>	Enter Bar Code Configuration
Calibration	<@CAL>	Enter Auto Calibration
	<@OPTIC>	Initiate Lens Calibration (Standard QX Hawk only)
Counters	<N>	No Read Counter
	<O>	No Read Counter Reset
	<T>	Trigger Counter
	<U>	Trigger Counter Reset
	<V>	Good Read/Match Counter
	<W>	Good Read/Match Counter Reset
	<X>	Mismatch Counter
	<Y>	Mismatch Counter Reset
Default/Reset/Save	<A>	Software Reset – Retain Current Parameters
	<Ard>	Software Reset – Recall Factory Defaults
	<Arp>	Software Reset – Recall Power-On Defaults
	<Arc>	Software Reset – Recall Customer Defaults
	<Z>	Software Reset – Save Current Settings for Power-On
	<Zc>	Software Reset – Save Current Settings as Customer Defaults
	<Zrd>	Software Reset – Recall Factory Defaults and Save for Power-On
	<Zrc>	Software Reset – Recall Customer Defaults and Save for Power-On
Device Control	<L1>	Output 1 Pulse
	<L2>	Output 2 Pulse
	<L3>	Output 3 Pulse
	<I>	End Current Read Cycle
	<H>	Enable Read Cycle
Firmware/Checksum	<#>	Display All Firmware Part Numbers
	<#a>	Display Application Firmware Part Number
	<#b>	Display Boot Firmware Part Number
	<#d>	Display DSP Firmware Part Number
	<#k>	Display Kernel Firmware Part Number
	<#p>	Display System Configuration File Part Number
	<#s>	Display SafeMode Firmware Part Number
	<#.>	Display All Firmware Build Numbers
	<#a.>	Display Application Firmware Build Number
	<#b.>	Display Boot Firmware Build Number
<#d.>	Display DSP Firmware Build Number	

## Serial Commands

<b>Firmware/Checksum</b>	<#k.>	Display Kernel Firmware Build Number
	<#p.>	Display System Configuration File Build Number
	<!>	Display All Available Firmware Checksums
	<la>	Display Application Firmware Checksum
	<ld>	Display DSP Firmware Checksum
	<lp>	Display System Configuration File Checksum
<b>Imager Status</b>	<?>	Imager Status Request
	<K?>	All Status Request
	<K??>	All Descriptor Request
	<K?#>	All Range Request
	<Knnn?>	Single Status Request
	<Knnn??>	Single Descriptor Request
	<Knnn?#>	Single Range Request
	<Knnnd>	Single Command Default
<b>Learn</b>	<LEARN>	Initiate Learn Operation
	<UNLEARN>	Initiate Unlearn Operation
	<LEARN?>	Display Learn Status
<b>Master Database</b>	<G>	Store Next Decoded Symbol to Database Index 1
	<Gn>	Store Next Decoded Symbol to Database Index <i>n</i>
	<NEWM>	New Master Load Status
<b>PDF Information</b>	<a1>	Enable/Disable PDF Information
<b>Read Rate</b>	<C>	Perform Decodes/Second Test
	<Cp>	Perform Decode Percent Test
	<J>	Exit Decodes/Second and Decode Percent Tests
<b>Reboot System</b>	<reboot>	Cold Boot System from Boot Code
<b>Static Validation</b>	<VAL>	Perform Static Validation of Data Matrix Symbol
<b>Targeting</b>	<l1>	Activate Targeting System (Standard QX Hawk only)
	<l0>	De-activate Targeting System (Standard QX Hawk only)
<b>Temperature</b>	<@TEMP>	Display Current Image Sensor Temperature
<b>Y-Modem Transfer</b>	<uy,path and image file name>	Y-Modem Upload
	<dy,key>	Y-Modem Download (Code)

## Appendix F — Protocol Commands

### Communication Protocol Command Table

Protocol Command (Mnemonic displayed on menu)	Control Characters (Entered in menu or serial command)	Hex Value	Effect of Command
RES	^D	04	Reset
REQ	^E	05	Request
EOT	^D	04	Reset
STX	^B	02	Start of Text
ETX	^C	03	End of Text
ACK	^F	06	Acknowledge
NAK	^U	15	Negative Acknowledge
XON	^Q	11	Begin Transmission
XOFF	^S	13	Stop Transmission

## **ACK/NAK Data Flow Examples**

### **Setup 1**

RES	0x00 (disabled)
REQ	0x00 (disabled)
STX	0x00 (disabled)
ETX	0x00 (disabled)
<b>ACK</b>	0x06
<b>NAK</b>	0x15
LRC	disabled

#### *Transfer 1*

HOST_TX	<K141,0>
imager_TX	'ACK'

#### *Transfer 2*

HOST_TX	<K141?>
imager_TX	'ACK'
imager_TX	<K141,0>
HOST_TX	'ACK'

### **Error Condition**

#### *Transfer 1*

imager_TX	symbol data
HOST_TX	'NAK' (host rejects)
imager_TX	symbol data (resend data)
HOST_TX	'ACK' (transaction complete)

#### *Transfer 2*

HOST_TX	<K141?>
imager_TX	'ACK'
imager_TX	<K141,0>
	timeout reached...
	timeout reached...
	timeout reached...
Timeout Reached	transaction aborted, data is flushed

## Setup 2

RES	0x00 (disabled)
REQ	0x00 (disabled)
STX	0x00 (disabled)
ETX	0x00 (disabled)
<b>ACK</b>	0x06
<b>NAK</b>	0x15
<b>LRC</b>	enabled

### *Transfer 1*

HOST_TX	<K141,0>a
imager_TX	'ACK'

### *Transfer 2*

HOST_TX	<K141?>B
imager_TX	'ACK'
imager_TX	<K141,0>a
HOST_TX	'ACK'

## **Error Condition**

### *Transfer 1*

HOST_TX	<k141,0>x (BAD LRC)
imager_TX	'NAK'
HOST_TX	<K141,0>a (GOOD LRC)
imager_TX	'ACK'

---

*Protocol Commands*

### **Setup 3**

<b>RES</b>	0x00 (disabled)
<b>REQ</b>	0x00 (disabled)
<b>STX</b>	0x28 '('
<b>ETX</b>	0x29 ')'
<b>ACK</b>	0x06
<b>NAK</b>	0x15
<b>LRC</b>	enabled

#### *Transfer 1*

HOST_TX	(<K141,0>)H
imager_TX	'ACK'

#### *Transfer 2*

HOST_TX	(<K141?>)k
imager_TX	'ACK'
imager_TX	(<K141,^M>)w
HOST_TX	'ACK'



## Setup 4

**RES**      0x21 '!'  
**REQ**      0x3D '='  
**STX**      0x28 '('  
**ETX**      0x29 ')'  
**ACK**      0x06  
**NAK**      0x15  
**LRC**      enabled

### Transfer 1

HOST\_TX      (<K141,0>)H  
 imager\_TX    'ACK'

### Transfer 2

HOST\_TX      (<K100?>)n  
 imager\_TX    'ACK'  
 HOST\_TX      '!'  
 imager\_TX    (<K100,8,0,0,1>)X  
 HOST\_TX      'ACK'  
 imager\_TX    '!'

## Error Condition

### Transfer 1

HOST\_TX      (<K141,0>)H  
 imager\_TX    'ACK'  
 HOST\_TX      (<K100?>)n  
 imager\_TX    'ACK'  
 HOST\_TX      '!'  
 imager\_TX    (<K100,8,0,0,1>)X  
               timeout reached...  
 imager\_TX    '='  
               timeout reached...  
 imager\_TX    '='  
               timeout reached...  
 imager\_TX    '='  
               timeout reached...  
 imager\_TX    '!'

## Polling Mode Data Flow Examples

### Setup 1

<b>Address</b>	0x01 (translates to) Poll Req @ '0x1C', Unit Select @ '0x1D'
<b>RES</b>	0x04
<b>REQ</b>	0x05
<b>STX</b>	0x02
<b>ETX</b>	0x03
<b>ACK</b>	0x06
<b>NAK</b>	0x15
<b>LRC</b>	disabled

### Transfer 1

HOST_TX	'RES' '0x1D' 'REQ' (Select Unit 1 to receive data)
imager_TX	'0x1D' 'ACK' (Unit responds with its address)
HOST_TX	'STX' <T> 'ETX'
imager_TX	'0x1D' 'ACK' (Unit responds with its address)
HOST_TX	'RES' (Terminate Transfer 2)

### Transfer 2

HOST_TX	'RES' '0x1C' 'REQ' (Poll Unit 1 for data)
imager_TX	'0x1C' 'STX' <T/00000> 'ETX'
HOST_TX	'ACK'
imager_TX	'RES' (Terminate Transfer 1)

Starting with a 'RES' ensures a clean transaction, without "leftovers" from the previous transaction.

### Error Condition 1

HOST_TX	'RES' '0x1C' 'REQ' (Poll Unit 1 for data)
imager_TX	'0x1C' 'STX' <T/00000> 'ETX'
HOST_TX	'Nothing' (Host should 'ACK' here)
	timeout reached...
imager_TX	'REQ' (Unit requests an 'ACK' again)
	timeout reached...
imager_TX	'REQ' (Unit requests an 'ACK' again)
	timeout reached...
imager_TX	'REQ' (Unit requests an 'ACK' again)
	timeout reached...
imager_TX	'RES' (Terminate Transfer 1, data is flushed)

**Error Condition 2**

HOST\_TX            'RES' '0x1C' 'REQ' (Poll Unit 1 for data)  
imager\_TX         '0x1C' 'STX' <T/00000> 'ETX'  
HOST\_TX            '*Nothing*' (Host should 'ACK' here)  
                  timeout reached...  
imager\_TX         'REQ' (Unit requests an 'ACK' again)  
HOST\_TX            '*NAK*' (Host rejects data frame)  
                  (Retry Event)  
imager\_TX         '0x1C' 'STX' <T/00000> 'ETX' (Unit sends again)  
HOST\_TX            'ACK' (Host receives data)  
imager\_TX         'RES' (Terminate Transfer 1)

The protocol makes 3 retry attempts before data is flushed and transfer is aborted.

## Setup 2

<b>Address</b>	0x01 (translates to) Poll Req @ '0x1C', Unit Select @ '0x1D'
<b>RES</b>	0x04
<b>REQ</b>	0x05
<b>STX</b>	0x02
<b>ETX</b>	0x03
<b>ACK</b>	0x06
<b>NAK</b>	0x15
<b>LRC</b>	enabled

### Transfer 1

HOST_TX	'RES' '0x1D' 'REQ' (Select Unit 1 to receive data)
imager_TX	'0x1D' 'ACK' (Unit responds with its address)
HOST_TX	'STX' <T> 'ETX' 'LRC'
imager_TX	'0x1D' 'ACK' (Unit responds with its address)
HOST_TX	'RES' (Terminate Transfer 2)

### Transfer 2

HOST_TX	'RES' '0x1C' 'REQ' (Poll Unit 1 for data)
imager_TX	'0x1C' 'STX' <T/00000> 'ETX' 'LRC'
imager_TX	'ACK'
HOST_TX	'RES' (Terminate Transfer 1)

Starting with a 'RES' ensures a clean transaction, without "leftovers" from the previous transaction.

### Error Condition 1

HOST_TX	'RES' '0x1C' 'REQ' (Poll Unit 1 for data)
imager_TX	'0x1C' 'STX' <T/00000> 'ETX' 'LRC'
HOST_TX	'Nothing' (Host should 'ACK' here)
	timeout reached...
imager_TX	'REQ' (Unit requests an 'ACK' again)
	timeout reached...
imager_TX	'REQ' (Unit requests an 'ACK' again)
	timeout reached...
imager_TX	'REQ' (Unit requests an 'ACK' again)
	timeout reached...
imager_TX	'RES' (Terminate Transfer 1, data is flushed)

**Error Condition 2**

HOST\_TX            'RES' '0x1C' 'REQ' (Poll Unit 1 for data)  
 imager\_TX        '0x1C' 'STX' <T/00000> 'ETX' 'LRC'  
 HOST\_TX            '*Nothing*' (Host should 'ACK' here)  
                   timeout reached...  
 imager\_TX        'REQ' (Unit requests an 'ACK' again)  
 HOST\_TX            '*NAK*' (Host rejects data frame)  
                   (Retry Event)  
 imager\_TX        '0x1C' 'STX' <T/00000> 'ETX' 'LRC' (Unit sends again)  
 HOST\_TX            'ACK' (Host receives data)  
 imager\_TX        'RES' (Terminate Transfer 1)

**Error Condition 3**

HOST\_TX            'RES' '0x1C' 'REQ' (Poll Unit 1 for data)  
 imager\_TX        '0x1C' 'STX' <T/00000> 'ETX' 'BAD LRC'  
 HOST\_TX            '*NAK*' (Host rejects bad LRC data)  
                   (Retry Event)  
 imager\_TX        '0x1C' 'STX' <T/00000> 'ETX' 'GOOD LRC' (Unit sends again)  
 HOST\_TX            'ACK' (Host receives data)  
 imager\_TX        'RES' Terminate Transfer 1)

The protocol makes 3 retry attempts before data is flushed and transfer is aborted.

# Appendix G — ASCII Table

Dec	Hex	Mne	Ctrl	Dec	Hex	Ch	Dec	Hex	Ch	Dec	Hex	Ch
00	00	NUL	^@	32	20	SP	64	40	@	96	60	`
01	01	SOH	^A	33	21	!	65	41	A	97	61	a
02	02	STX	^B	34	22	"	66	42	B	98	62	b
03	03	ETX	^C	35	23	#	67	43	C	99	63	c
04	04	EOT	^D	36	24	\$	68	44	D	100	64	d
05	05	ENQ	^E	37	25	%	69	45	E	101	65	e
06	06	ACK	^F	38	26	&	70	46	F	102	66	f
07	07	BEL	^G	39	27	'	71	47	G	103	67	g
08	08	BS	^H	40	28	(	72	48	H	104	68	h
09	09	HT	^I	41	29	)	73	49	I	105	69	i
10	0A	LF	^J	42	2A	*	74	4A	J	106	6A	j
11	0B	VT	^K	43	2B	+	75	4B	K	107	6B	k
12	0C	FF	^L	44	2C	,	76	4C	L	108	6C	l
13	0D	CR	^M	45	2D	-	77	4D	M	109	6D	m
14	0E	SO	^N	46	2E	.	78	4E	N	110	6E	n
15	0F	SI	^O	47	2F	/	79	4F	O	111	6F	o
16	10	DLE	^P	48	30	0	80	50	P	112	70	p
17	11	DC1	^Q	49	31	1	81	51	Q	113	71	q
18	12	DC2	^R	50	32	2	82	52	R	114	72	r
19	13	DC3	^S	51	33	3	83	53	S	115	73	s
20	14	DC4	^T	52	34	4	84	54	T	116	74	t
21	15	NAK	^U	53	35	5	85	55	U	117	75	u
22	16	SYN	^V	54	36	6	86	56	V	118	76	v
23	17	ETB	^W	55	37	7	87	57	W	119	77	w
24	18	CAN	^X	56	38	8	88	58	X	120	78	x
25	19	EM	^Y	57	39	9	89	59	Y	121	79	y
26	1A	SUB	^Z	58	3A	:	90	5A	Z	122	7A	z
27	1B	ESC	^[	59	3B	;	91	5B	[	123	7B	{
28	1C	FS	^\	60	3C	<	92	5C	\	124	7C	
29	1D	GS	^]	61	3D	=	93	5D	]	125	7D	}
30	1E	RS	^^	62	3E	>	94	5E	^	126	7E	~
31	1F	US	^_	63	3F	?	95	5F	_	127	7F	D

## Appendix H — Configuring Ethernet TCP/IP

When using Ethernet to deploy QX Hawks in an application, the host computer must be in the same IP range as the devices. Network settings are accessible in Windows from the Control Panel. The steps below show how TCP/IP settings can be configured.

1. From the **Windows Start Menu**, open **Control Panel** and double-click **Network Connections**.

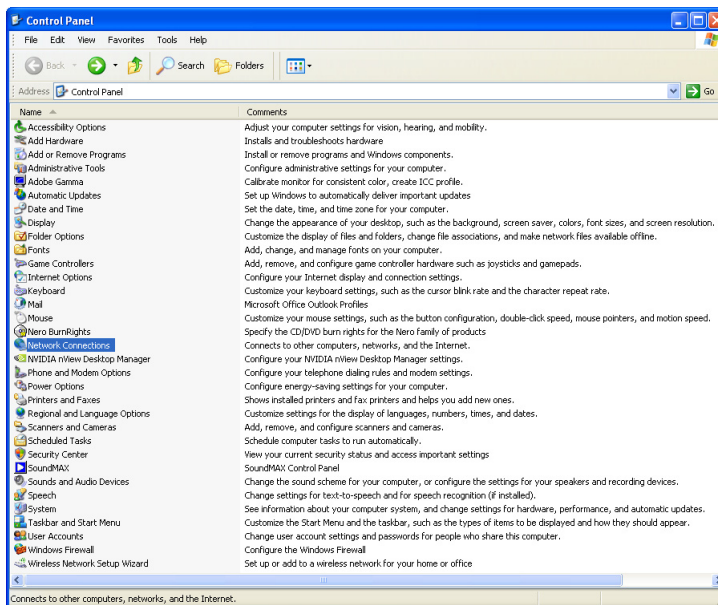

2. The **Network Connections** dialog will appear. Double-click the icon for the Local Area Connection being used in the application.

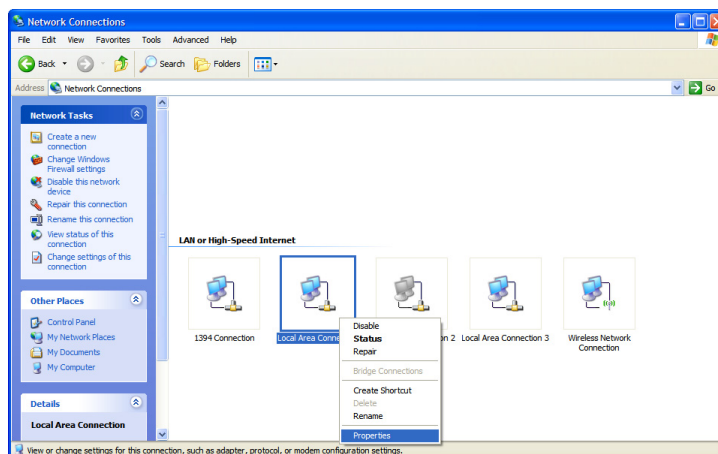

## Configuring Ethernet TCP/IP (cont.)

3. The **Local Area Connection Status** dialog will appear. To check the host computer's connection settings, click **Details** on the **Support** tab.

To verify connection status:

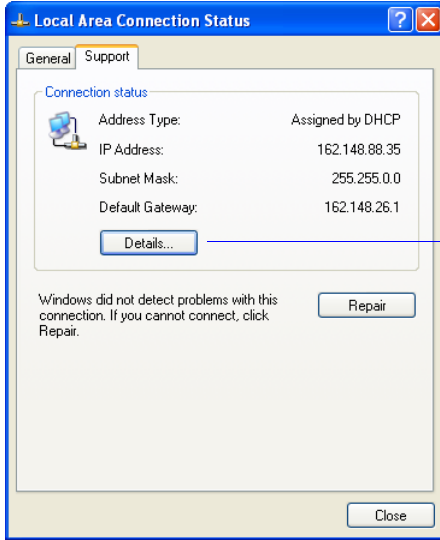

On the **Support** tab, click the **Details** button to bring up a list of **Network Connection Details**.

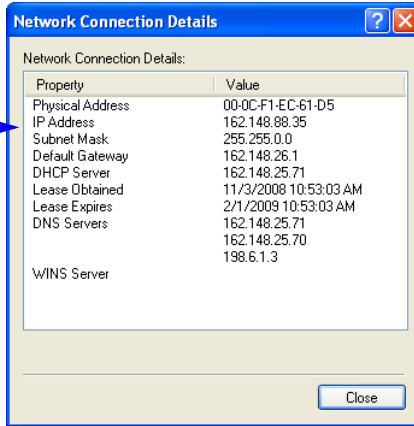

4. A connected QX Hawk's default address information can be verified in ESP by clicking the **Search** button in the **Connection Wizard**. Compare the imager's IP address to the host's IP address to determine whether or not they are in the same subnet range (this can be determined by your I.T. department if you are unsure).

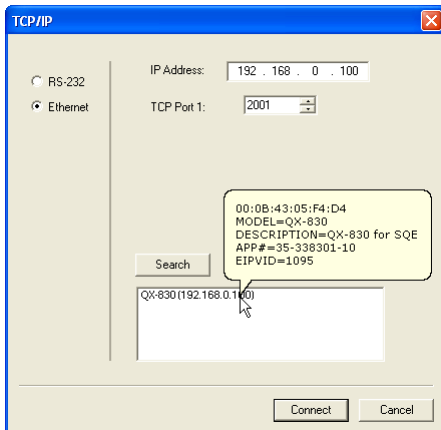



## Configuring Ethernet TCP/IP (cont.)

5. To change the host computer's connection settings, click **Properties** on the **General** tab.

### To change TCP/IP settings:

On the **General** tab, click the **Properties** button to bring up a list of items being used by the current connection. On the **Local Area Connection Properties** dialog, double-click **Internet Protocol (TCP-IP)**.

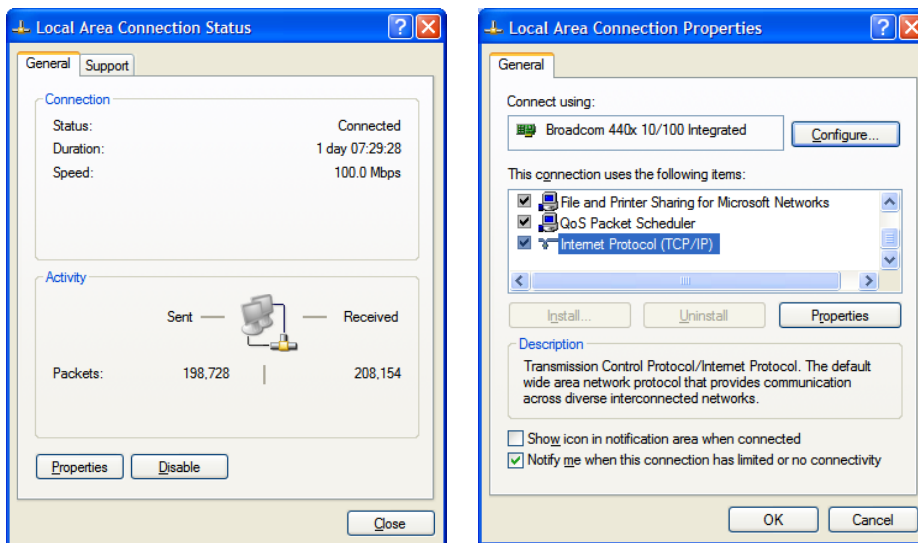

6. The **Internet Protocol (TCP/IP) Properties** dialog will appear.

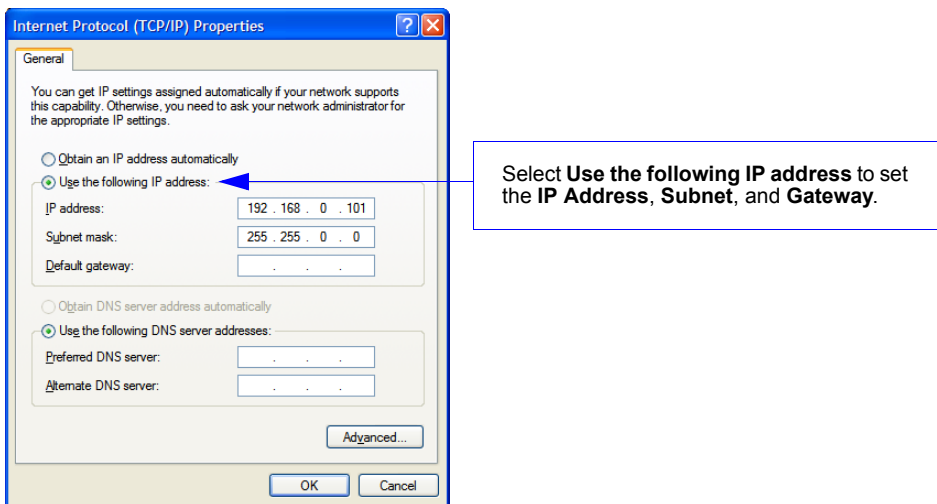

## Appendix I — Using EtherNet/IP

### Overview

The EIP interface will be identified as a Generic Device (0x00). The interface is designed to support remote serial transmit and receive using explicit unconnected messaging.

### Necessary Tools

The following tools are helpful for configuring the EIP:

- EtherNet/IP Messaging Tool – can be a PLC or Software Tool, must be capable of sending explicit messages and establishing Class 1 connections. [EIPScan](#) is an example of such a tool.
- Terminal emulation or serial communication tool that can connect to a TCP socket, such as HyperTerminal.
- ESP – Microscan's Easy Setup Program. This tool has the ability to find Microscan products on the network, configure their ip address, then configure all application parameters.

### EtherNet/IP Terms of Use

EtherNet/IP Technology is governed by the Open DeviceNet Vendor Association, Inc (ODVA). Any person or entity that makes and sells products that implement EtherNet/IP Technology must agree to the Terms of Usage Agreement issued by ODVA. See [www.odva.org](http://www.odva.org) for details.

### Device Type

The EtherNet/IP device type is 0x00, Generic Device.

### Vendor ID

Microscan's Vendor ID is **1095**.

### Product Code

The Product Code is **6800**.

### QX Hawk EtherNet/IP Object Model

QX Hawk uses Class 1 connected messaging to communicate most data in three different io assemblies. The user chooses one of two input assemblies, plus the output assembly, to create a Class 1 connection.

#### Connection properties supported:

Class: 1

Trigger Mode: Cyclic and Change of State

Cyclic Rate: Greater than 20 ms recommended. 10 ms minimum.

Size: Fixed

Type: Point-to-Point (PLC OUT, O->T), Point-to-Point and Multicast (PLC IN, T->O)

Priority: Low, High, and Scheduled

## Data Types

Microscan Data Type	AB PLC	ODVA CIP EDS	Description
U8	SINT	USINT	Unsigned, 8 bit
U32	DINT	UDINT	Unsigned, 32 bit
STRING32	STRING	UDINT and BYTE[]	A 32 bit length field, followed by 8 bit ASCII characters

### QX Hawk Small IN Assembly 0x64, 100 decimal (IN = QX Hawk -> PLC)

Field #	Data Type	Size (# of Data Type Elements)	Field Name
0	U32	1	User-Defined Tag Echo Echo from asm OUT 0xC6
1	U32 (32 bit flags)	1	Command Echo Echo from asm OUT 0xC6
2	U32 (32 bit flags)	1	Output Control Echo Echo from asm OUT 0xC6
3	U32	1	Read Cycle Sequence Counter: When this value changes, it indicates the following read cycle report fields have changed. 0 = Read cycle report has been "reset" to "empty". Read cycle report data is only valid when Sequence is not 0.
4	STRING 32	U32 + U8[64]	Read Cycle Report: Decoded Data Up to 64, 8-bit chars The first U32 is the length of the bar code data in the U8[64] field.
		Total= 84 U8, or 21 U32	

This is a small, lightweight input assembly. It is a subset of the "Big IN Assembly 0x65". It provides feedback of the output assembly, and the text of any bar codes decoded by the imager.

See **Big IN Assembly 0x65** for a description of the data fields.

**QX Hawk Big IN Assembly 0x65, 101 decimal (IN = QX Hawk -> PLC)**

Field #	Data Type	Size (# of Data Type Elements)	Field Name
0	U32	1	User-Defined Tag Echo Echo from asm OUT 0xC6
1	U32 (32 bit flags)	1	Command Echo Echo from asm OUT 0xC6
2	U32 (32 bit flags)	1	Output Control Echo Echo from asm OUT 0xC6
3	U32 (32 bit flags)	1	External Input Status (Physical Pin State)
4	U32 (32 bit flags)	1	External Output Status (Physical Pin State)
5	U32 (32 bit flags)	1	Device Status
6	U32	1	Read Cycle Sequence Counter: When this value changes, it indicates the following read cycle report fields have changed. 0 = Read cycle report has been “reset” to “empty”. Read cycle report data is only valid when Sequence is not 0.
7	U32	1	Read cycle report: Trigger count <T>
8	U32	1	Read cycle report: Decode/Match count <V>
9	U32	1	Read cycle report: Mismatch count <X>
10	U32	1	Read cycle report: Noread count <N>
11	STRING 32	U32 + U8[128]	Read cycle report: Decoded Data Up to 128, 8-bit chars The first U32 is the length of the bar code data in the U8[128] field.
		Total= 176 U8, or 44 U32	

This contains more status information, and a longer bar code string, than the “Small IN Assembly 0x64”. This gives the PLC visibility of the device’s discrete io, current operational status, and read cycle counters.

## User Defined Tag Echo, Command Echo, Output Control Echo

These are a direct echo of the equivalent fields in the OUT assembly. They provide the PLC programmer with a method of verifying that the OUT data has been received by QX Hawk.

### External Input Status (Physical Pin State)

Bit #	Pin Name
0	Trigger
1	New Master
2-31	Reserved

0 = no current sensed on input

1 = current sensed on input

### External Output Status (Physical Pin State)

Bit #	Pin Name
0	Out1
1	Out2
2	Out3
3-31	Reserved

0 = output contact is open

1 = output contact is closed

### Device Status

Field #	Bit Name	State
0	Reserved	
1	New Master Requested	1 = New Master Requested
2-7	Reserved	
8	Scanning Disabled	1 = Scanning Disabled
9-15	Reserved	
16	In Read Cycle	1 = In Read Cycle
17	Actively Scanning	1 = Active Scanning

Note the following details with “In Read Cycle” and “Actively Scanning” signals:

1. They may be very short-lived. It is possible for the imager to begin and end a read cycle without these signals being seen in active state.
2. They are only valid for normal read cycle operation: continuous, serial, and triggered. They do not reflect operation during bar code configuration, read rate, auto-calibration, or ESP “Setup” mode.

## Read Cycle Sequence Counter

When this value changes, it indicates a new read cycle report is present.

Read cycle report data is only valid when Sequence is not 0.

Read cycle reports are only output during normal read cycles: continuous, serial, and triggered. Read cycle reports are not output during bar code configuration, read rate, auto-calibration, or ESP “Setup” mode.

## Read Cycle Report: Trigger, Decode/Match, Mismatch, No Read Count

These are the historical read cycle result counters. By comparing the values to a previous report, the number of decodes, mismatches and noreads in the current read cycle can be determined.

## Read Cycle Report: Decode Data

This string has the same format that would be output a serial port or tcp connection, with one difference: preamble and postamble are not added.

## QX Hawk OUT Assembly 0xC6, 198 decimal: Command (OUT= PLC -> QX Hawk)

Field #	Data Type	Size (# of Data Type Elements)	Field Name
0	U32	1	User-Defined Tag
1	U32 (32 bit flags)	1	Command
2	U32 (32 bit flags)	1	External Output Control

### ***User Defined Tag***

This provides the PLC programmer a method of uniquely identifying multiple imagers in the system. This field serves no functional purpose in the QX Hawk. The value sent by the PLC for this field is echoed back to the input assemblies.

## Command

Bit #	Action
0	Trigger
1	New Master
2-7	Reserved
8	Disable Scanning
9-15	Reserved
16	Clear Read Cycle Report and Counters
17	Unlatch Outputs
18-31	Reserved

The PLC programmer should verify that a Command has been received by QX Hawk by observing the equivalent “echo” field in the IN assemblies.

### Trigger (0)

Edge event-driven. Takes effect when read mode is Serial, Edge, or Level. A transition from 0 to 1 is a rising edge trigger event. A transition from 1 to 0 is a falling edge trigger event. The following sources all induce trigger events in the imager, including:

- A serial command from a serial com port
- EZ button
- External Trigger input signal on connector A
- Command:Trigger bit in the OUT assembly

If the imager is to be exclusively triggered by the PLC, then all other trigger sources must be kept idle.

### New Master (1)

Edge-event driven. A transition from 0 to 1 is a command to the unit similar to sending the <G> serial command, or activating the New Master input on connector A. When activated, the New Master function instructs the imager to store the next decode in the master symbol database.

### Disable Scanning (8)

Operates the same as the <H> and <I> commands. A transition from 0 to 1 is the same as sending an <I> command, which issues a “disable” event. A transition from 1 to 0 is the same thing as sending an <H> command, which issues an “enable” event. Note that the most recent command, either <H> or <I> serial commands or the Camera Action:DisableScanning command will always override the previous “scanning disable” state. To verify scanning status, observe the DeviceStatus field in asm 0x65.

### Clear Read Cycle Report and Counters (16)

Trigger, Decode/Match, Mismatch, Noread, Decoded Data string, and Sequence. A transition from 0 to 1 is similar to sending the commands <U><W><Y><O>, which clear the historical read cycle counters. Also, the Sequence counter and Decoded Data string will go to 0. Note that if this command is received while a read cycle is active, execution of the command will be delayed until the read cycle has ended, and the read cycle's information will probably be lost.

### Unlatch Outputs (17)

If any outputs are configured for “Unlatch on Input1”, a transition from 0 to 1 will unlatch the output. See configuration commands K810-812. It is not necessary for Input 1 to be enabled.

### External Output Control

Bit #	Pin Name
0	Out1
1	Out2
2	Out3
3-31	Reserved

0 = open the output contact

1 = close the output contact

**Note:** Not operational at this time.

### QX Hawk OUT Assembly 0xC7, 199 decimal: Serial Command (OUT: PLC -> QX Hawk)

Field #	Data Type	Size (# of Data Type Elements)	Field Name
0	U32	1	Length of Command String (Field 1)
1	U8	256	Command String

Accessible only by unconnected explicit message.

This assembly enables the PLC to send serial commands to the device, similar to a serial port.

### Known Issues and Limitations

1. External Output Control has not been implemented yet.
2. There is currently no way to receive serial command responses back from the QX Hawk.



## Programming Flow Charts

Triggered by PLC, symbol data required, timeout or decode ends read cycle.

### Setup:

Read Cycle Trigger Mode = External Edge or External Level.

Symbol Data Output = Enabled globally and for EtherNet/IP.

When to Output = As Soon As Possible.

End of Read Cycle = Timeout.

No Read message = Enabled.

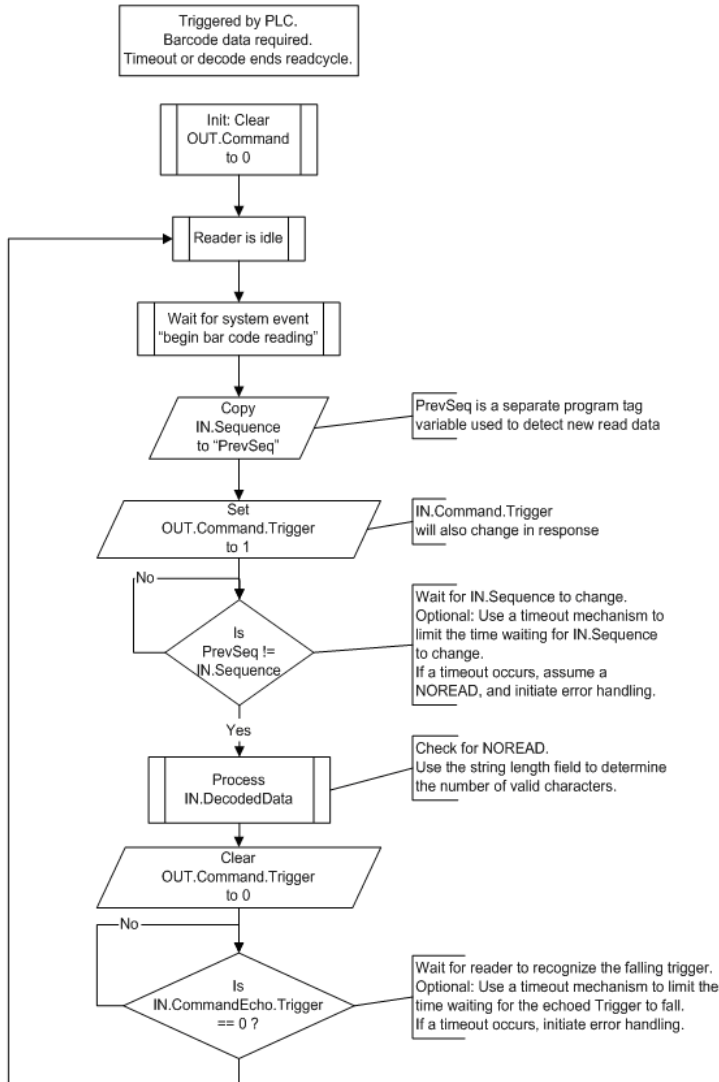

## NET and MOD LED Indicators

### MOD (Module)

Indicator State	Summary	Requirement	Microscan Implementation
Steady <b>OFF</b>	No power	If no power is supplied to the device, the module status indicator will be steady <b>OFF</b> .	Per requirement
Steady <b>GREEN</b>	Device operational	If the device is operating correctly, the module status indicator will be steady <b>GREEN</b> .	Per requirement
Steady <b>RED</b>	Major fault	If the device has detected a non-recoverable minor fault, the module status indicator will be steady <b>RED</b> .	Safe Mode: Basic comm. only. Scanning system non-functional.
Flashing <b>GREEN / RED</b>	Self-test	While the device is performing its power-up testing, the module status indicator will be flashing <b>GREEN / RED</b> .	Per requirement.

### NET (Network)

Indicator State	Summary	Requirement	Microscan Implementation
Steady <b>OFF</b>	No power, no IP address	If the device does not have an IP address (or is powered off), the network status indicator will be steady <b>OFF</b> .	Per requirement. Before device has acquired an IP address via DHCP.
Flashing <b>GREEN</b>	No connections	If the device has no established connections, but has obtained an IP address, the network status indicator will be flashing <b>GREEN</b> .	Per requirement. After device has acquired an IP address (static or DHCP).
Steady <b>GREEN</b>	Connected	If the device has at least one established connection (even to the Message Router), the network status indicator will be steady <b>GREEN</b> .	Per requirement.
Flashing <b>RED</b>	Connection timeout	If one or more of the connections in which the device is the target has timed out, the network status indicator will be flashing <b>RED</b> .	Per requirement.
Steady <b>RED</b>	Duplicate IP	If the device has detected that its IP address is already in use, the network status indicator will be steady <b>RED</b> .	Not implemented.
Flashing <b>GREEN / RED</b>	Self-test	While the device is performing its power-up testing, the module status indicator will be flashing <b>GREEN / RED</b> .	Per requirement.

## Appendix J — Allen-Bradley Version 16 PLC Setup

This section was created and run on the following Allen Bradley/Rockwell components:

- RSLogix 5000 Version 16
- ControlLogix 5561 processor
- 756-ENBT/A EtherNet/IP interface card, firmware version 4.003 or newer.

This setup procedure was also followed in RSLogix with a CompactLogix 5332E as the processor, though the final program was not tested with a CompactLogix processor.

1. Create the I/O Configuration for the base system, including the system's Ethernet interface:

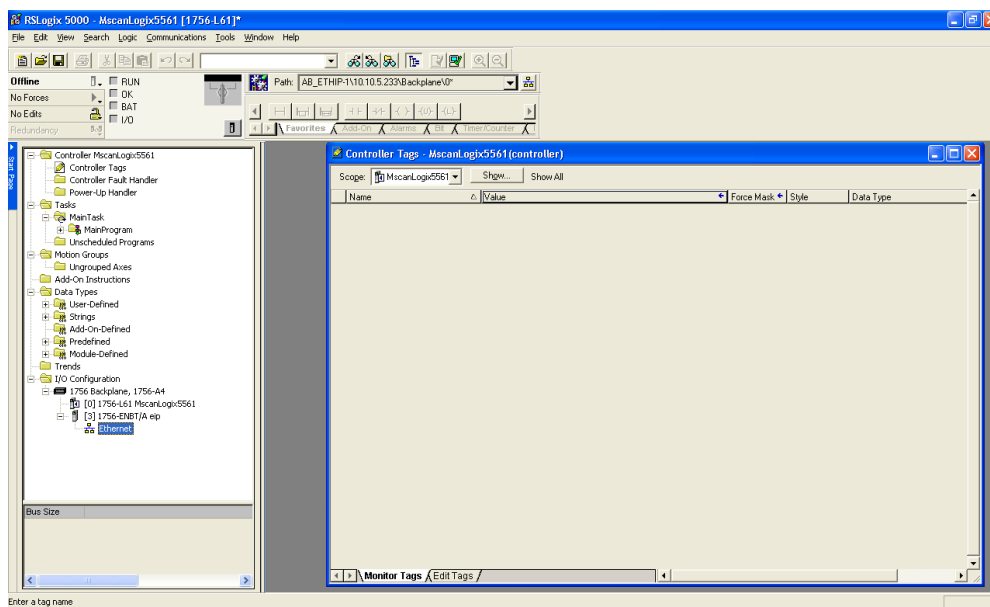

2. Add QX Hawk by right-clicking on the Ethernet interface, and select “New Module”:

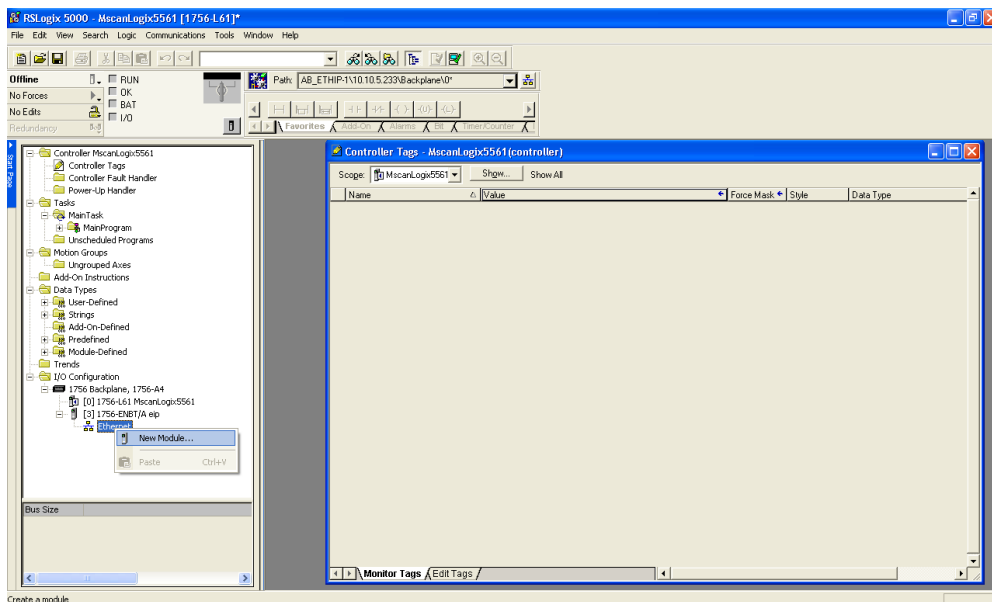

3. Select “ETHERNET-MODULE Generic Ethernet Module”, and click OK:

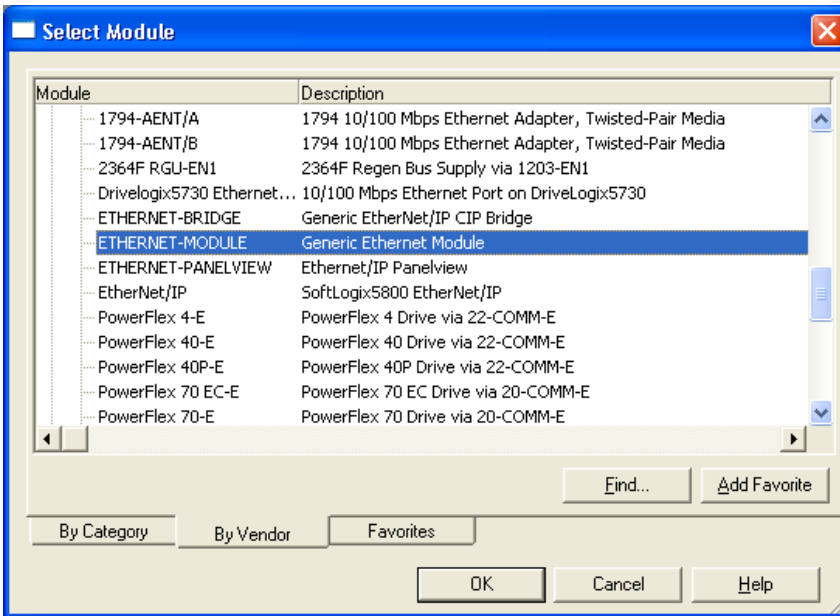

4. Configure the following fields:

“Name” = A useful name to remember the unit

“IP Address” = The IP Address of QX Hawk

“Comm Format” = “Data – DINT”

“Input” “Assembly Instance” = Choose either 100 (Small) or 101 (Big)

“Input” “Size” = 21 (Small), or 44 (Big)

“Output” “Assembly Instance” = 198

“Output” “Size” = 3

“Configuration” “Assembly Instance” = 1

“Configuration” “Size” = 0 (none)

5. Click OK when done.

Example: For Small IN (Instance 100, Size 21):

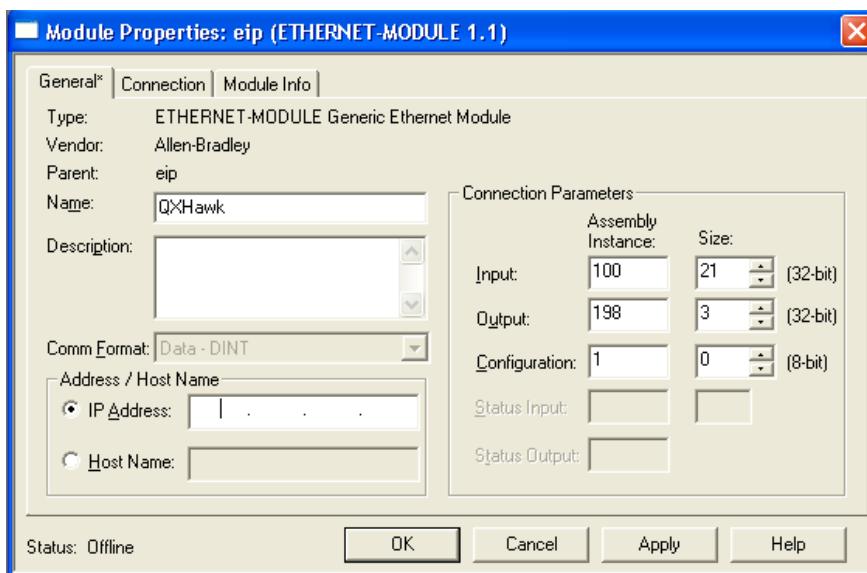

## Allen-Bradley Version 16 PLC Setup

Example: For Big IN (Instance 101, Size 44):

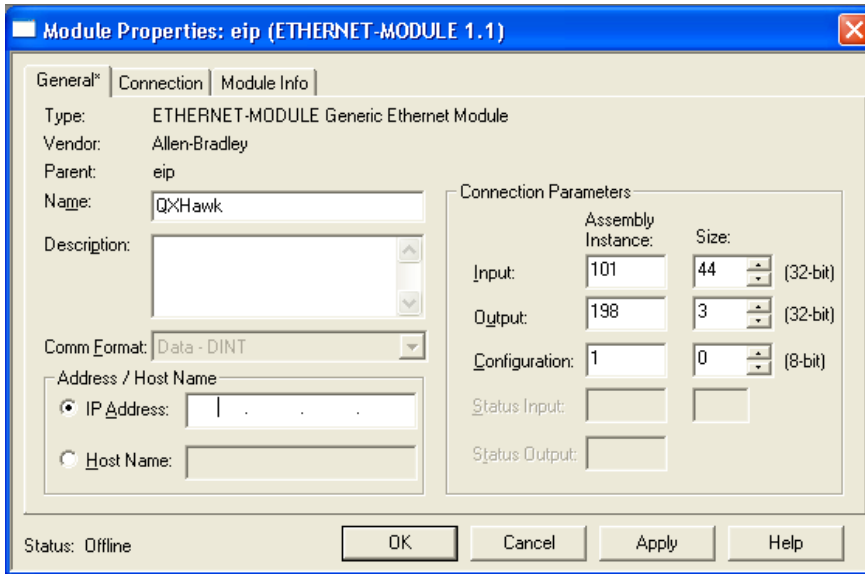

6. Configure the “Required Packet Interval (RPI)” and click OK. 20 ms or slower is strongly recommended. 10 ms is the minimum allowed by QX Hawk:

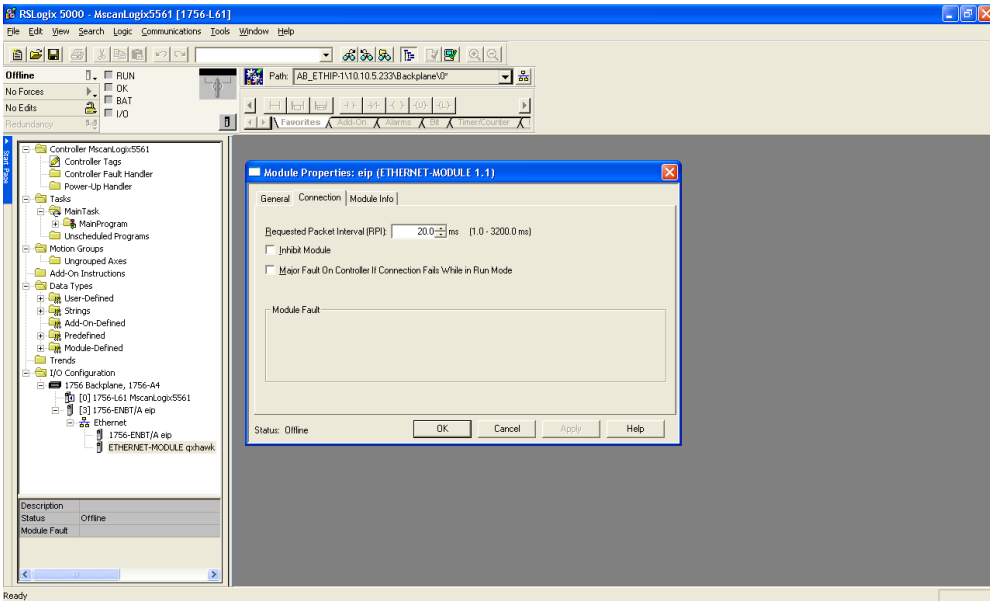

7. Double-click on the “Controller Tags” item, and verify QX Hawk’s :I and :O tags appear in the Controller Tags window:

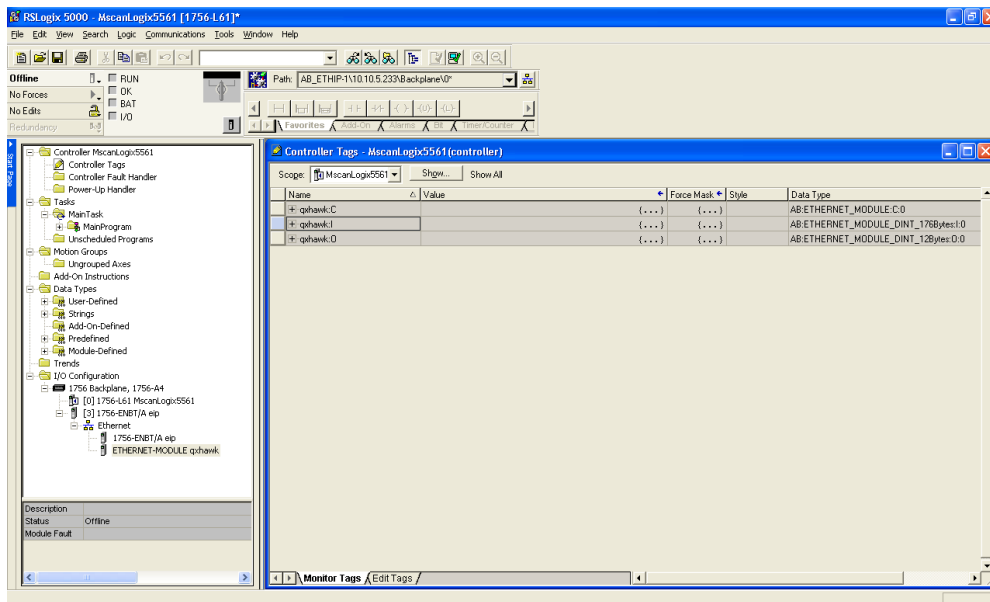

8. Open the “Main Routine”:

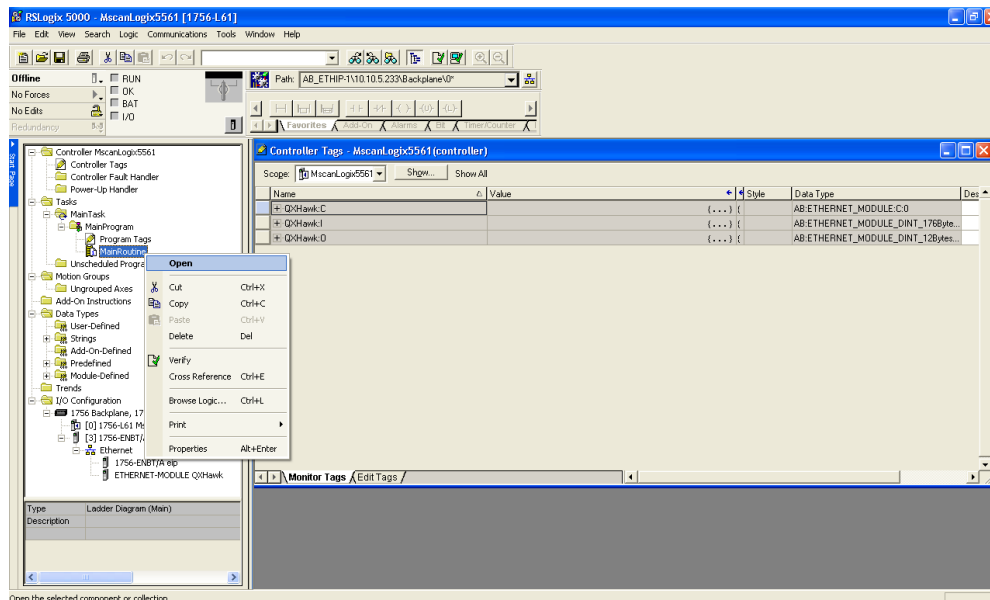

Open the selected component or collection

9. Right-click on the top rung and select "Import Rung":

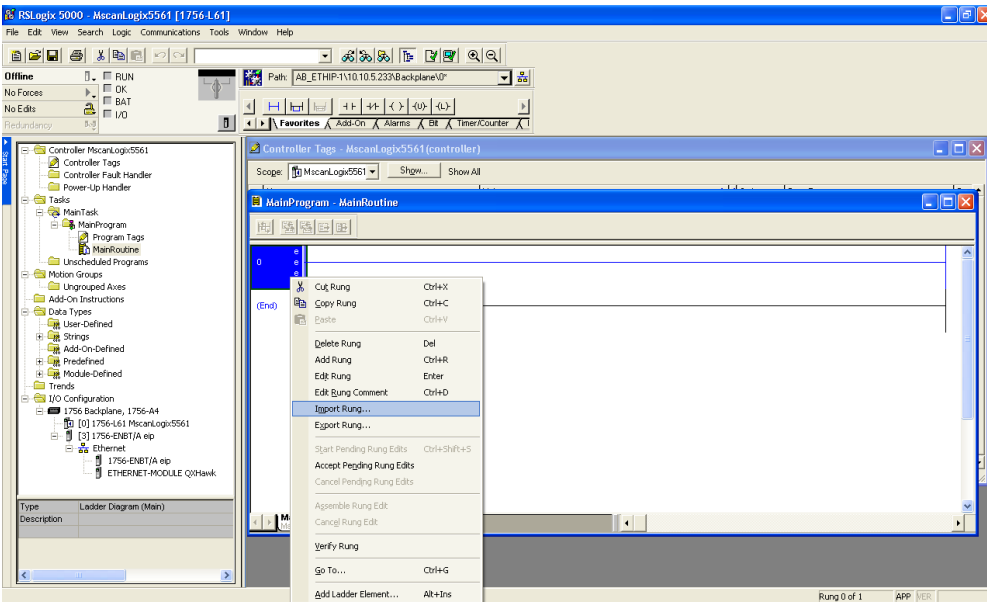

10. Click the **Attachments** icon in this PDF to show the **32-000001-xx.L5X** file. Save the file to the location of your choice. Navigate to the file and click **Import**.

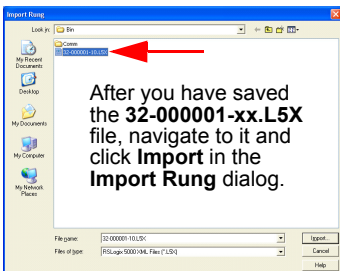
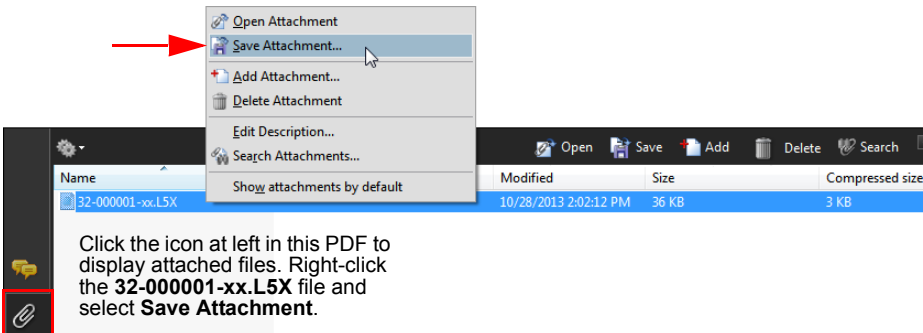



- At the “Import Configuration” window, link the first two items to the module name assigned earlier:

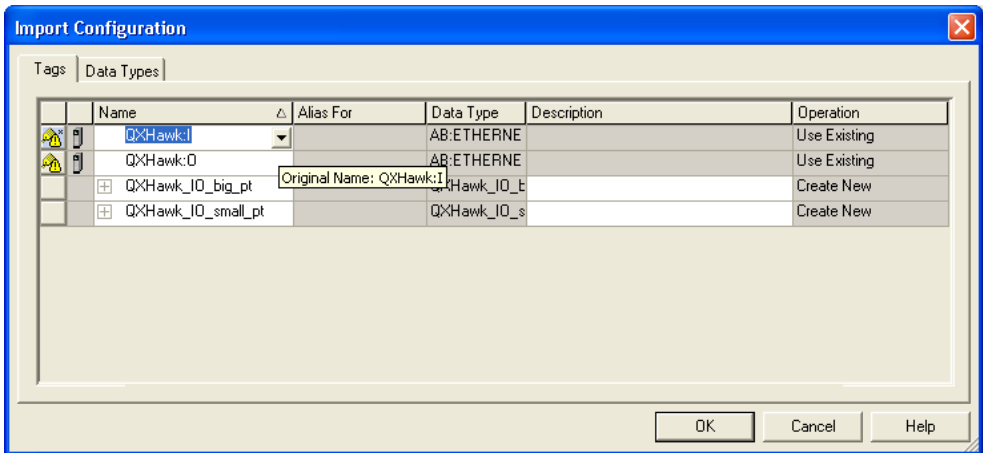

- Link “:I” to the input assembly:

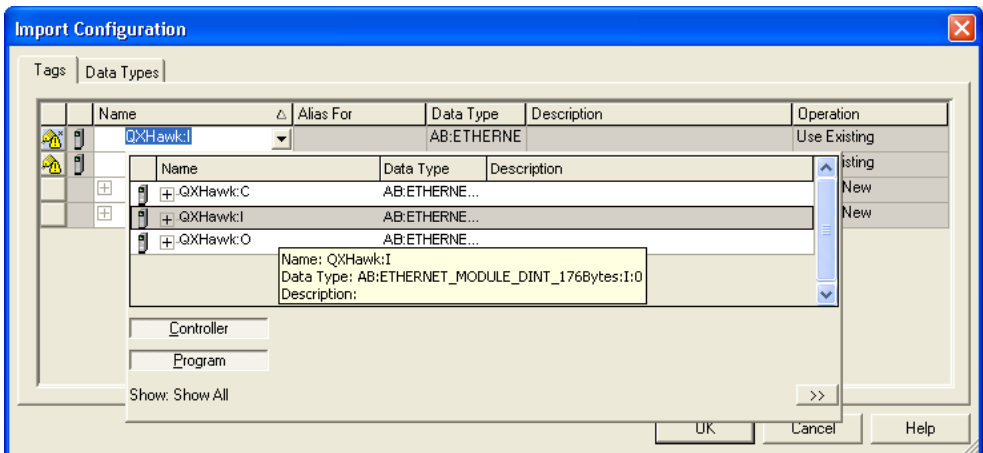

13. Link “:O” to the output assembly:

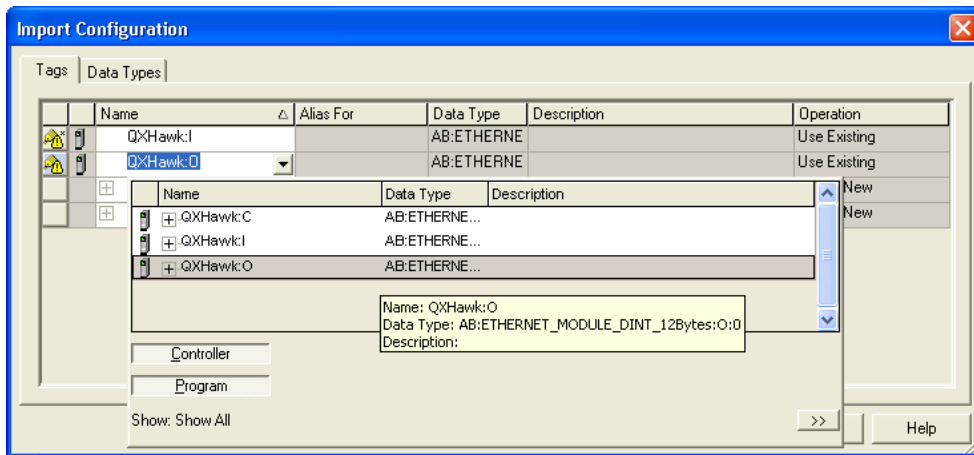

14. Delete any empty rungs:

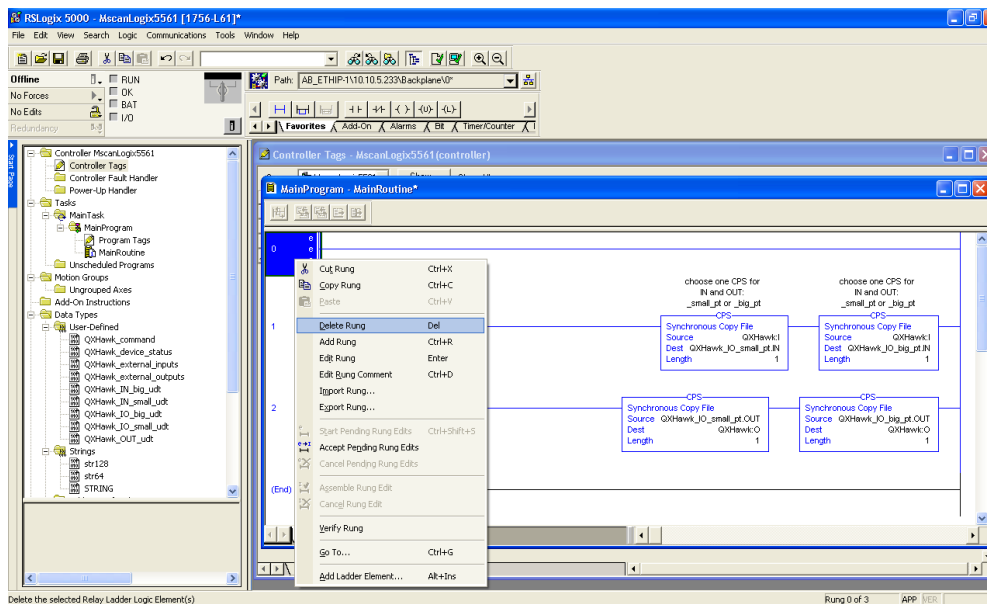

15. Select one CPS instruction per rung, the “\_small\_pt” on the left, or the “\_big\_pt” on the right. Keep the one that corresponds to the assembly sizes configured for the module, and delete the other:

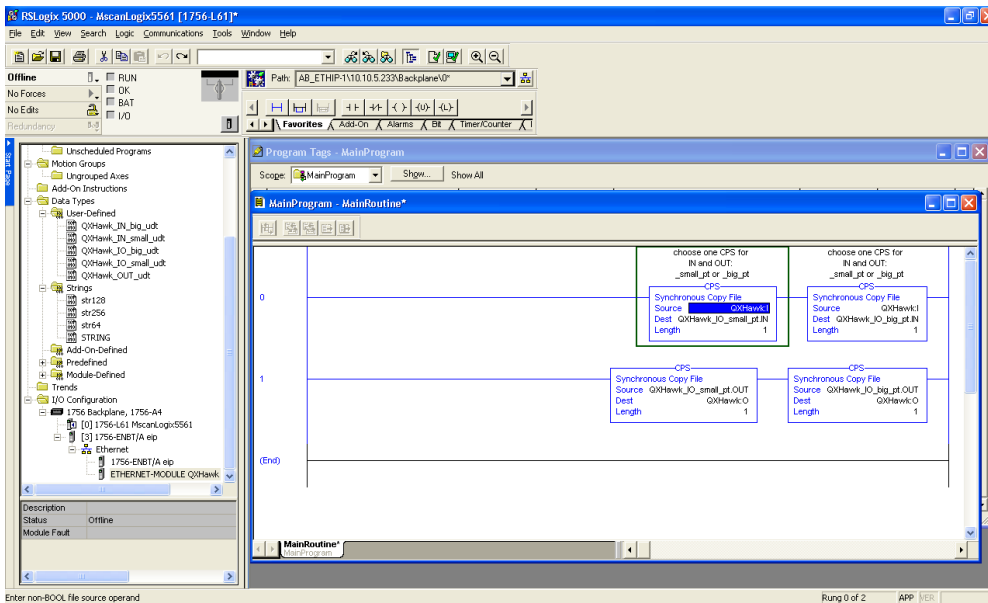

16. In this example, the small assembly set has been kept:

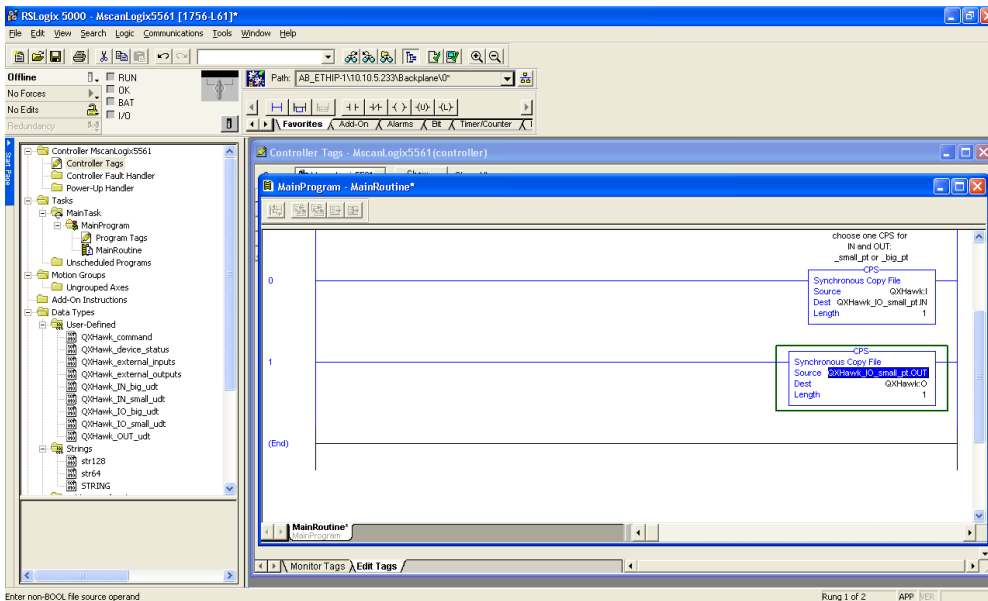

## Allen-Bradley Version 16 PLC Setup

In this example, the big assembly set has been kept:

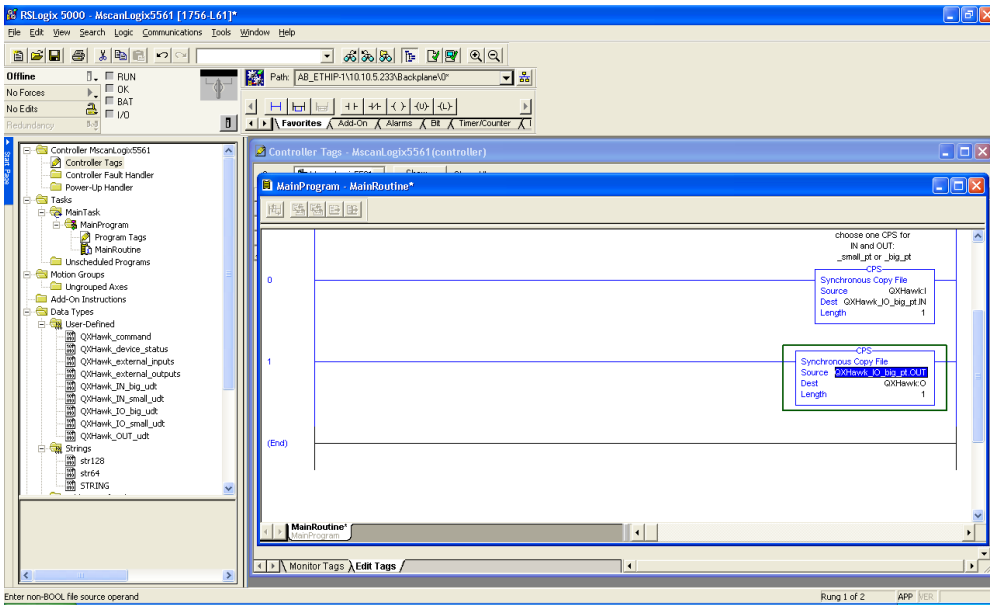

For the remainder of this document, the big assembly set is demonstrated. The system is now configured enough to test communication with QX Hawk.

17. Select the control button next to “Offline”, and select “Download”:

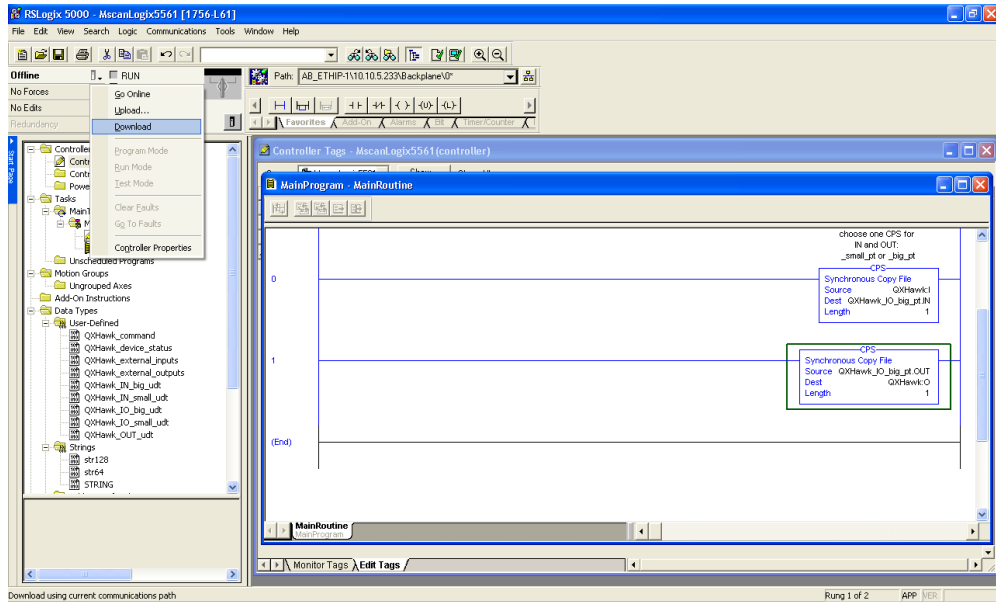

18. Once the program has downloaded, make sure the PLC is in Run Mode:

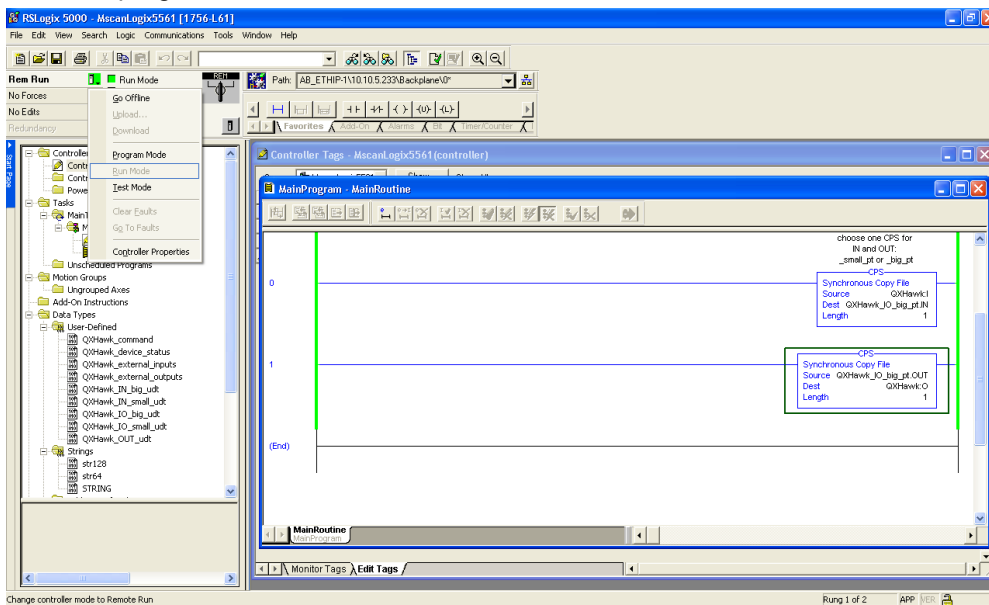

19. To open the Program Tags, right-click on "Program Tags" and select "Monitor Tags":

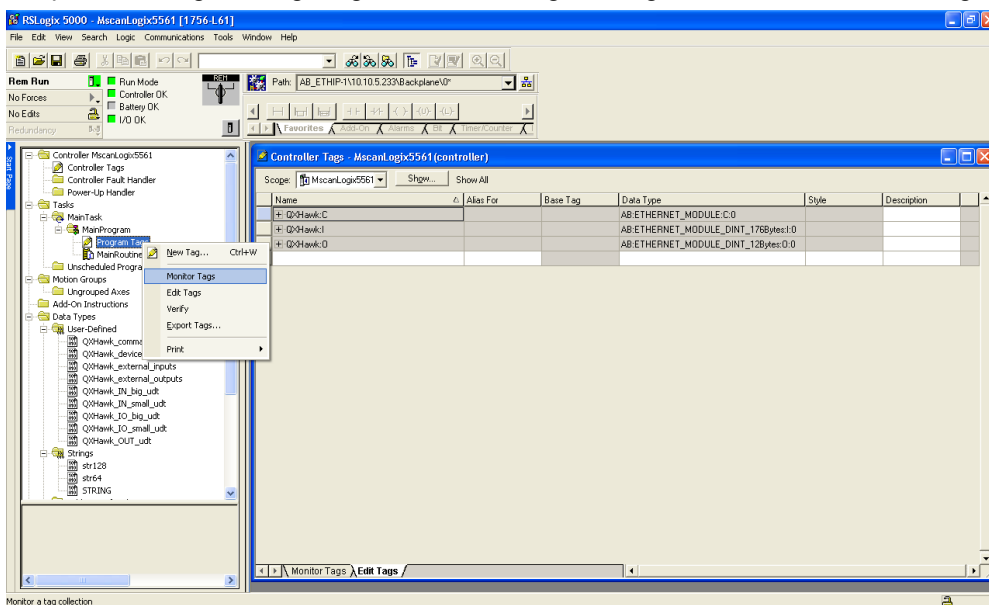

20. Expand the “QXHawk\_IO\_big\_pt” so that the .IN and .OUT structures and values are visible:

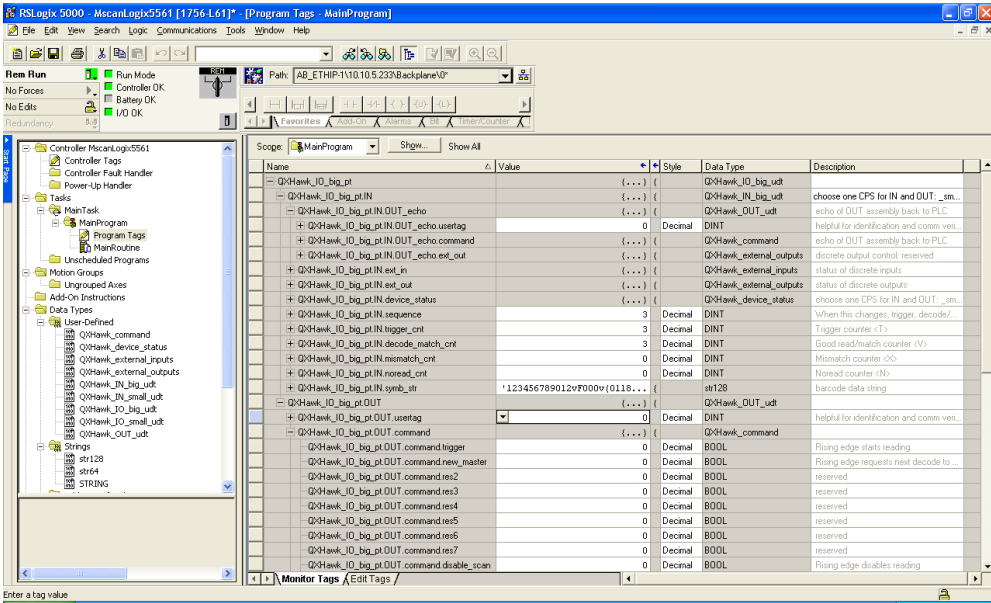

21. Change the “.OUT.usertag” to non-zero:

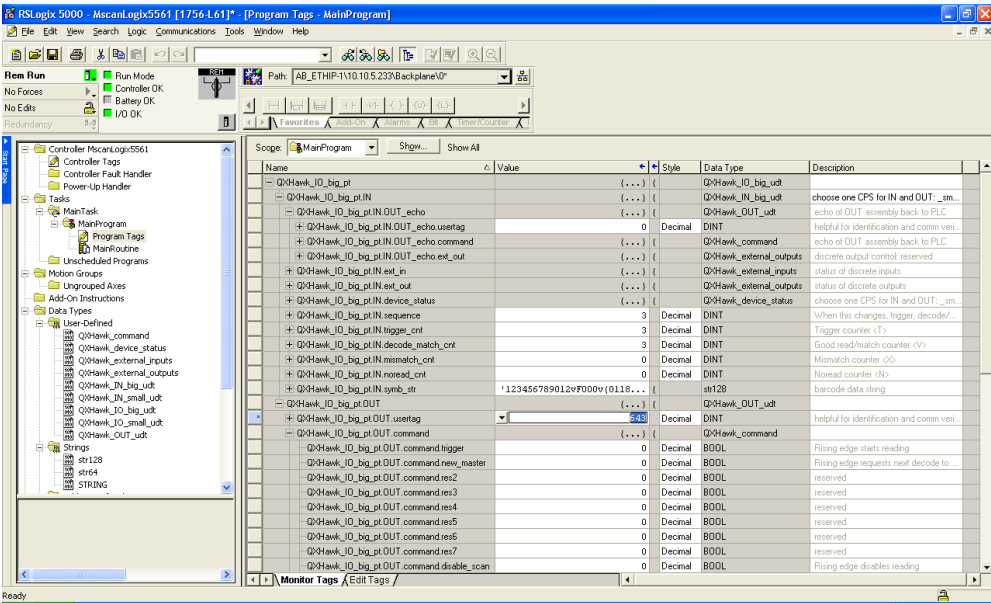

The “.IN.usertag\_echo” will change to match the same value as the “.OUT.usertag”:

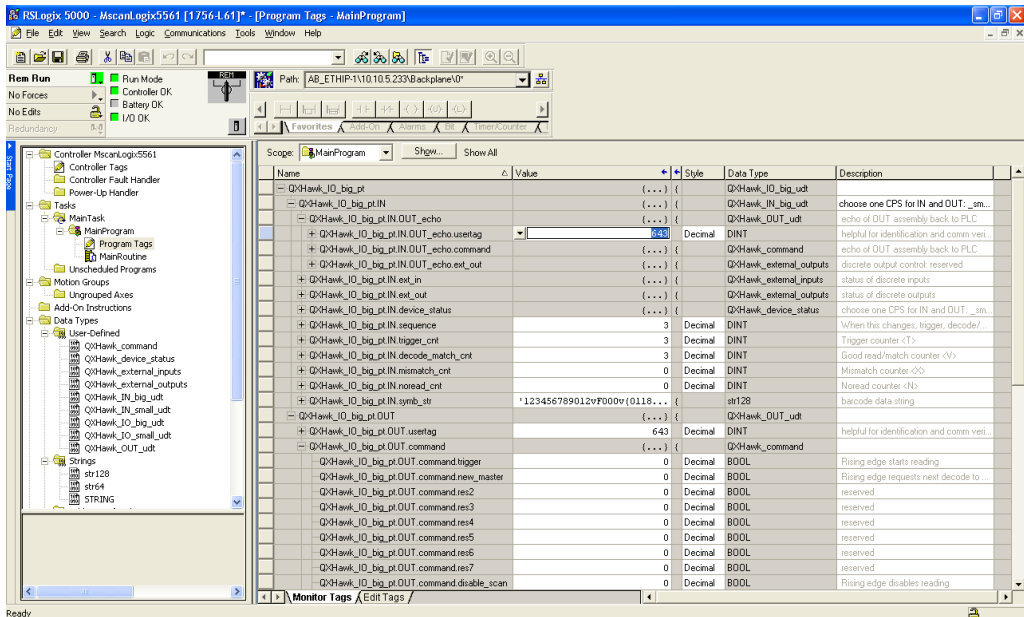

This confirms that two-way communication with QX Hawk is successful. It is left to the programmer to move or modify the CPS instructions in the Main Program according to the application's requirements.

Operation of the data fields within the assemblies is described in the object model documentation.

## Appendix K — Allen-Bradley Version 20 PLC Setup

- To add a new EDS file to RSLogix 5000 Version 20 select the **EDS Hardware Installation Tool** from the menu item under **Tools**.

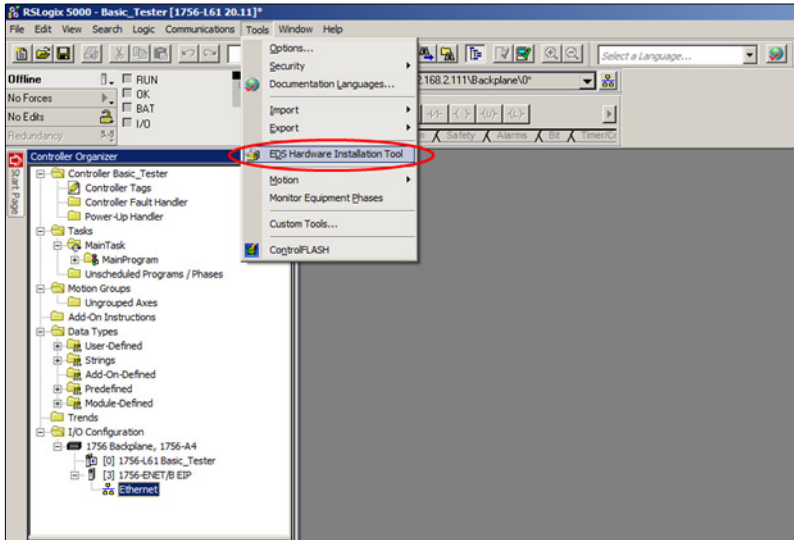

- Click the **Next** button.





- Make sure the **Register an EDS file(s)** radio button is selected, then click **Next**.

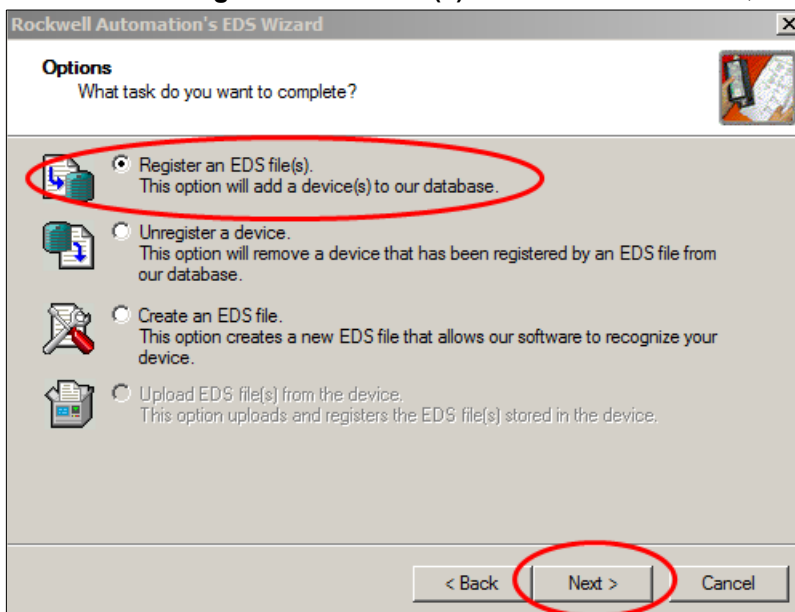

- Click the **Browse** button to locate the new EDS file on your PC. Then click **Next**.

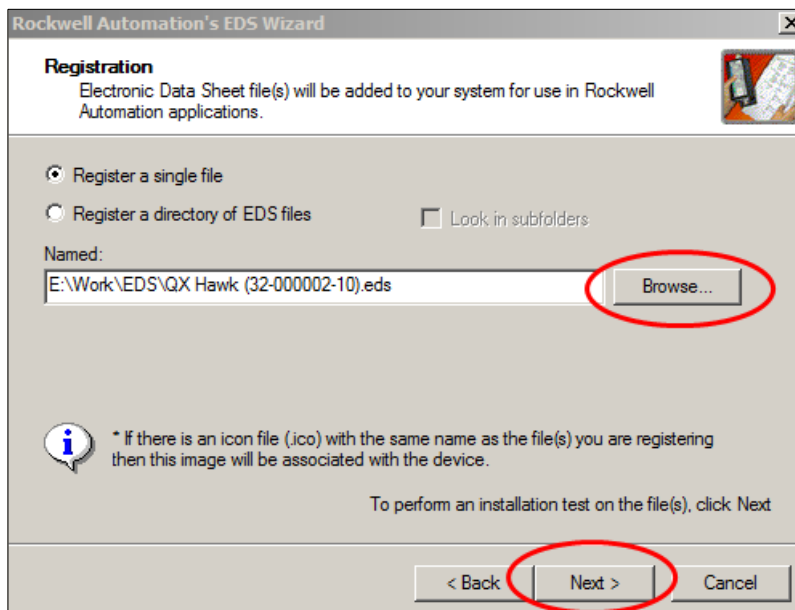

- Click the **Next** button.

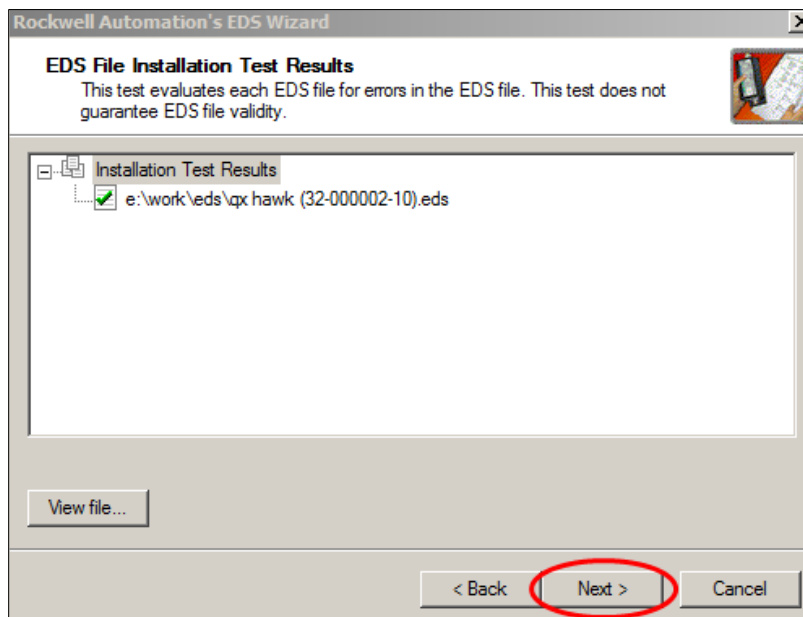

- Click the **Next** button.

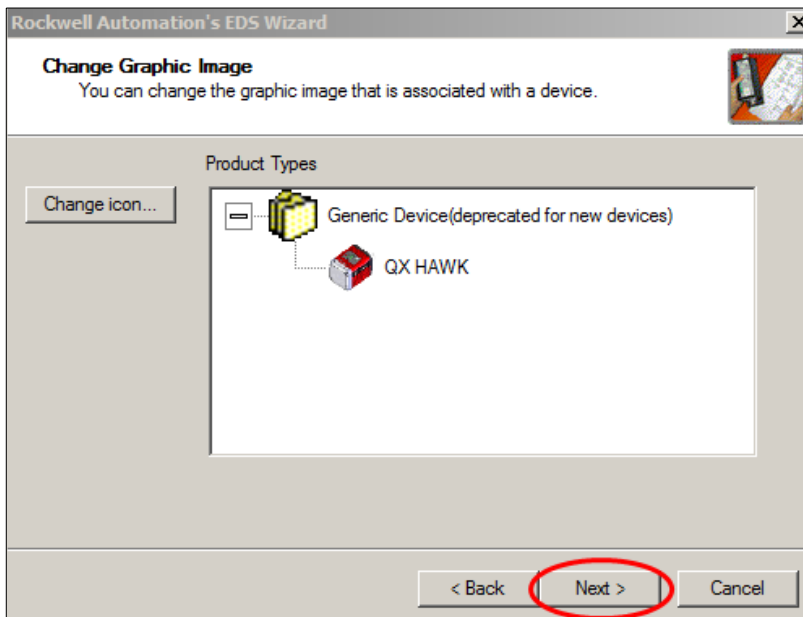

- Click the **Next** button.

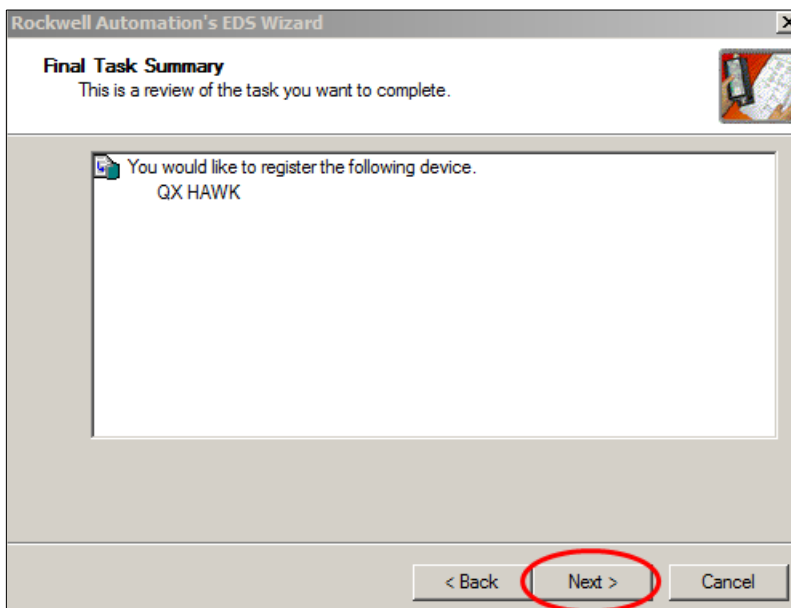

- Click the **Finish** button.

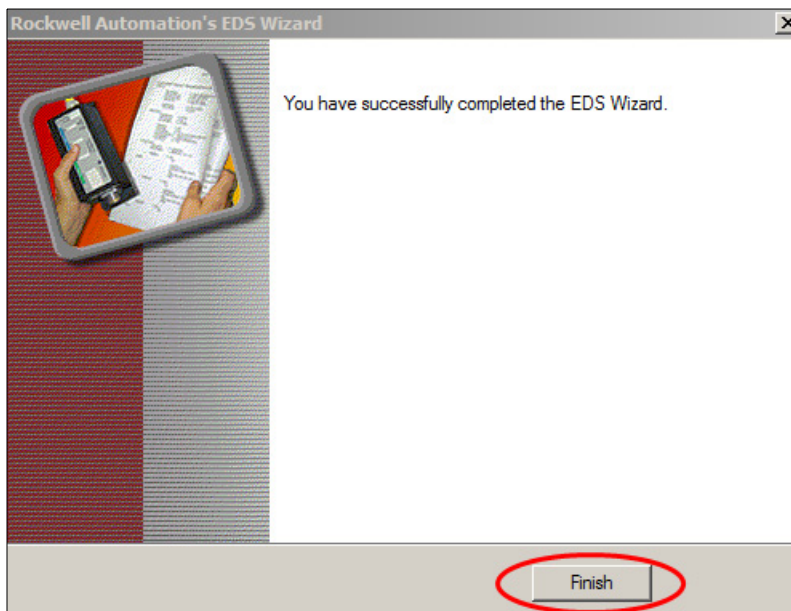

## Allen-Bradley Version 20 PLC Setup

- Now the EDS file has been loaded into RSLogix's database. Right-click the **Ethernet** menu item and select **New Module**.

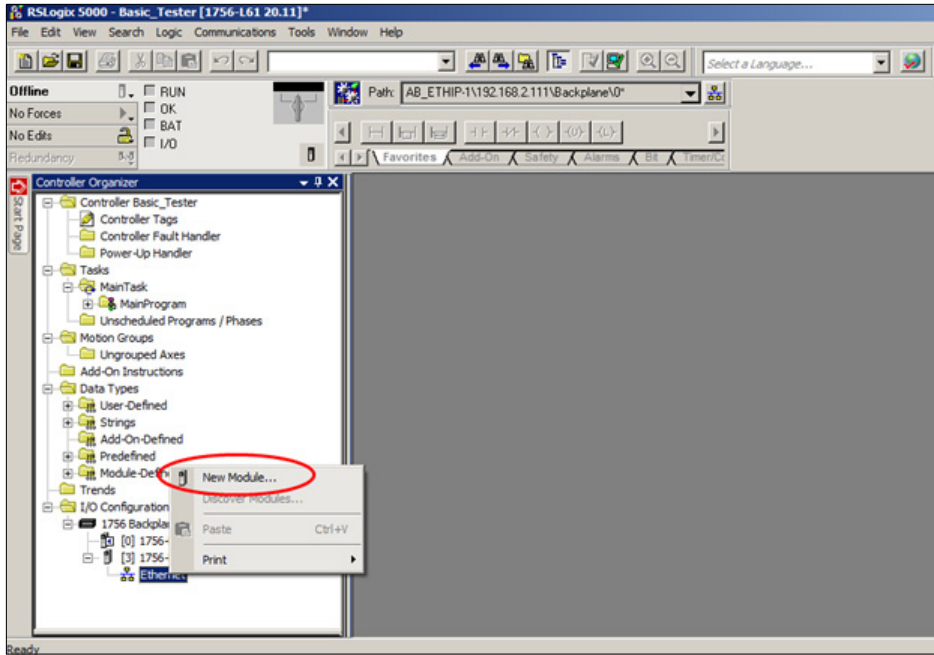

- To find your camera in the list, type **fis** and the dialog will show only devices with the letters “fis” in the name. Either double-click the camera you want or highlight it and click the **Create** button.

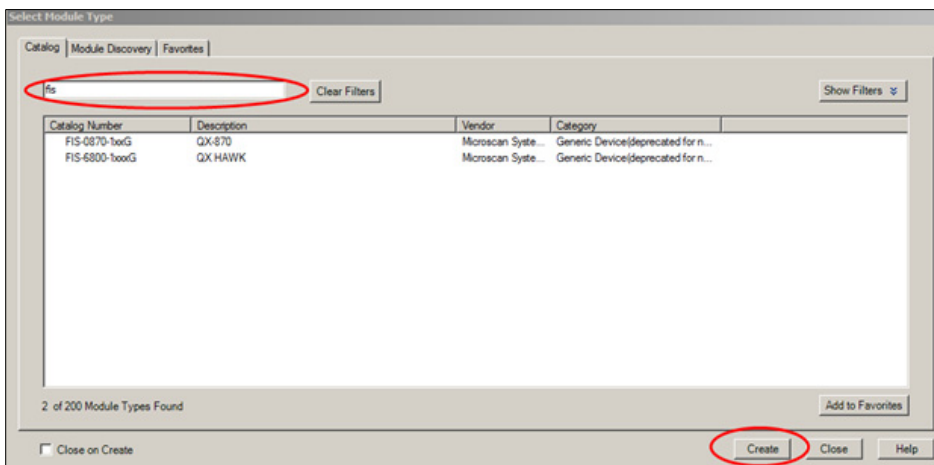

- Enter the name of the device used in the PLC program and the IP address of the camera.

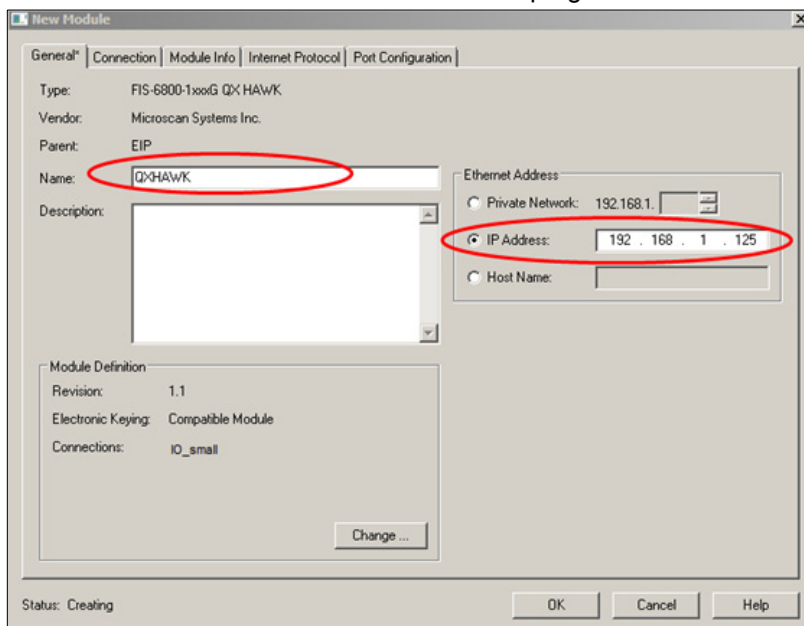

- After the new device has been added to the project, the default assembly data will be the **small** size. You can change it to large by double-clicking the camera menu item in the tree control and clicking the **Change** button on the dialog.

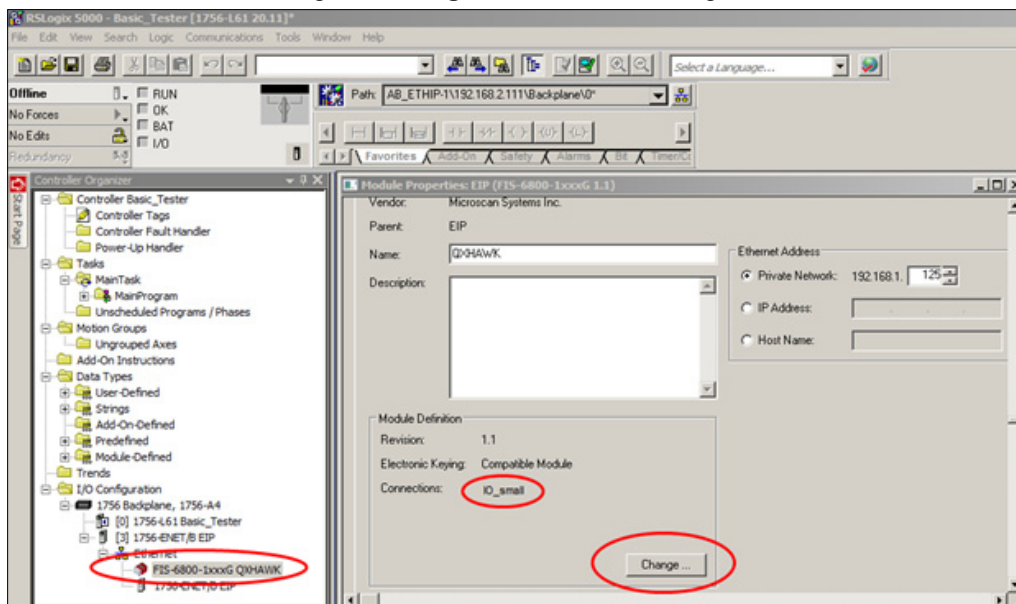

## Allen-Bradley Version 20 PLC Setup

- Select the large assembly size and click the **OK** button when done.

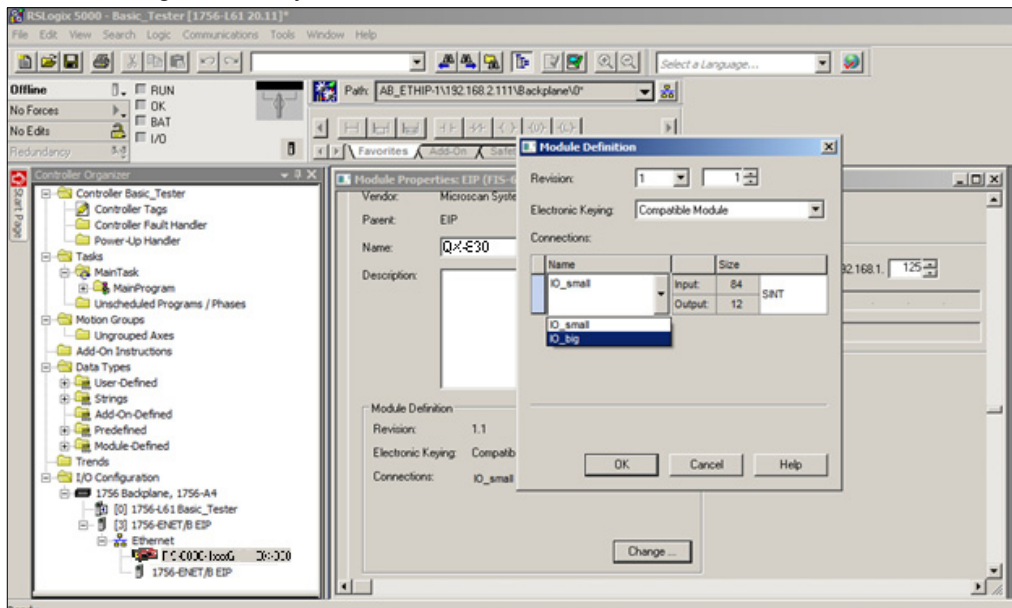

## Testing Communications

### Using Controller Tags

- Open the **Controller Tags** dialog and select the **Monitor Tags** tab at the bottom. Then expand the output array. The trigger bit is the first bit of the 5th byte offset which is **data[4].0**. Setting this bit to **1** should trigger a read on the camera.

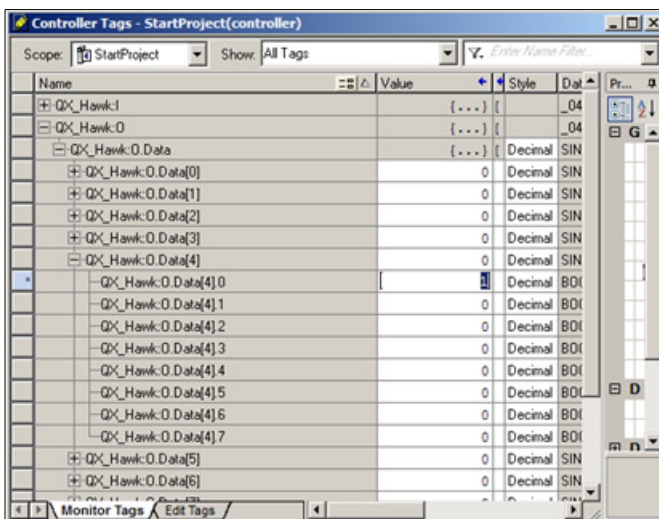

Data Type	Size (Bytes)	Field Name
U32	4	User-Defined Tag
U32	4	Command
U32	4	External Output Control

Command Bits				
17	16	8	1	0
Unlatch Outputs	Clear Read Cycle Report Counters	Disable Scanning	New Master	Trigger

## Allen-Bradley Version 20 PLC Setup

- The read data will be in the input array. For the **IO\_small** connection size scroll down to where **data[16]** is the first byte of the read data length and **data[20]** is the start of the data string.

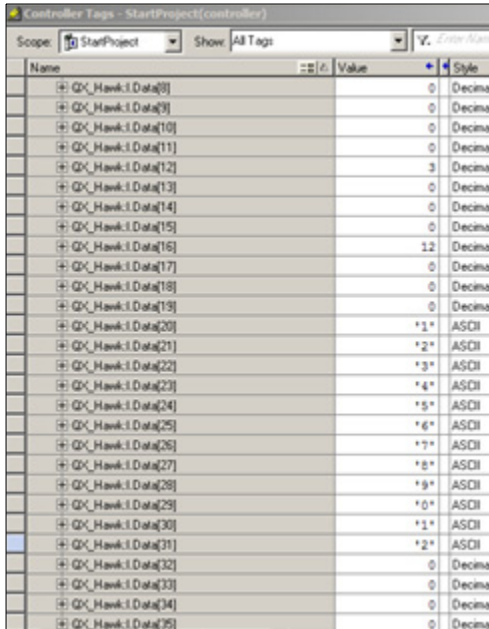

Name	Value	Style
QX_Hawk-I.Data[8]	0	Decimal
QX_Hawk-I.Data[9]	0	Decimal
QX_Hawk-I.Data[10]	0	Decimal
QX_Hawk-I.Data[11]	0	Decimal
QX_Hawk-I.Data[12]	3	Decimal
QX_Hawk-I.Data[13]	0	Decimal
QX_Hawk-I.Data[14]	0	Decimal
QX_Hawk-I.Data[15]	0	Decimal
QX_Hawk-I.Data[16]	12	Decimal
QX_Hawk-I.Data[17]	0	Decimal
QX_Hawk-I.Data[18]	0	Decimal
QX_Hawk-I.Data[19]	0	Decimal
QX_Hawk-I.Data[20]	*1*	ASCII
QX_Hawk-I.Data[21]	*2*	ASCII
QX_Hawk-I.Data[22]	*3*	ASCII
QX_Hawk-I.Data[23]	*4*	ASCII
QX_Hawk-I.Data[24]	*5*	ASCII
QX_Hawk-I.Data[25]	*6*	ASCII
QX_Hawk-I.Data[26]	*7*	ASCII
QX_Hawk-I.Data[27]	*8*	ASCII
QX_Hawk-I.Data[28]	*9*	ASCII
QX_Hawk-I.Data[29]	*0*	ASCII
QX_Hawk-I.Data[30]	*1*	ASCII
QX_Hawk-I.Data[31]	*2*	ASCII
QX_Hawk-I.Data[32]	0	Decimal
QX_Hawk-I.Data[33]	0	Decimal
QX_Hawk-I.Data[34]	0	Decimal
QX_Hawk-I.Data[35]	0	Decimal

- For the **IO\_big** connection size scroll down where **data[44]** is the first byte of the read data length and **data[48]** is the start of the data string.

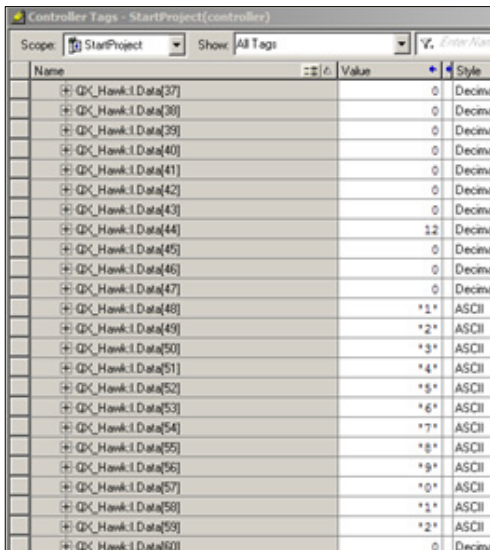

Name	Value	Style
QX_Hawk-I.Data[37]	0	Decimal
QX_Hawk-I.Data[38]	0	Decimal
QX_Hawk-I.Data[39]	0	Decimal
QX_Hawk-I.Data[40]	0	Decimal
QX_Hawk-I.Data[41]	0	Decimal
QX_Hawk-I.Data[42]	0	Decimal
QX_Hawk-I.Data[43]	0	Decimal
QX_Hawk-I.Data[44]	12	Decimal
QX_Hawk-I.Data[45]	0	Decimal
QX_Hawk-I.Data[46]	0	Decimal
QX_Hawk-I.Data[47]	0	Decimal
QX_Hawk-I.Data[48]	*1*	ASCII
QX_Hawk-I.Data[49]	*2*	ASCII
QX_Hawk-I.Data[50]	*3*	ASCII
QX_Hawk-I.Data[51]	*4*	ASCII
QX_Hawk-I.Data[52]	*5*	ASCII
QX_Hawk-I.Data[53]	*6*	ASCII
QX_Hawk-I.Data[54]	*7*	ASCII
QX_Hawk-I.Data[55]	*8*	ASCII
QX_Hawk-I.Data[56]	*9*	ASCII
QX_Hawk-I.Data[57]	*0*	ASCII
QX_Hawk-I.Data[58]	*1*	ASCII
QX_Hawk-I.Data[59]	*2*	ASCII
QX_Hawk-I.Data[60]	0	Decimal



- The input data assembly is as follows.

Small In	"Input"	
100	0x64	
84	0x54	21 (32-bit points)
Size (Bytes)	Field Name	Byte Offset
4	User-Defined Tag Echo	0-3
4	Command Echo	4-7
4	Output Control Echo	8-11
4	Read Cycle Sequence Counter	12-15
4+64	Read cycle report: Decoded Data	16-19, 20-83

Big In	"Input"	
101	0x65	
176	0xB0	44 (32-bit points)
Size (Bytes)	Field Name	Byte Offset
4	User-Defined Tag Echo	0-3
4	Command Echo	4-7
4	Output Control Echo	8-11
4	External Input Status	12-15
4	External Output Satus	16-19
4	Device Status	20-23
4	Read Cycle Sequence Counter	24-27
4	Read cycle report: Trigger count <T>	28-31
4	Read cycle report: Decode/Match count <V>	32-35
4	Read cycle report: Mismatch count <X>	36-39
4	Read cycle report: Noread count <N>	40-43
4+128	Read cycle report: Decoded Data	44-47, 48-175

**Note:** If the camera fails to read, make sure to enable **External Trigger** in **ESP**.

## Using Add-On-Instruction Tags

- Insert the new AOI into the program. Create the proper tags and associated links.

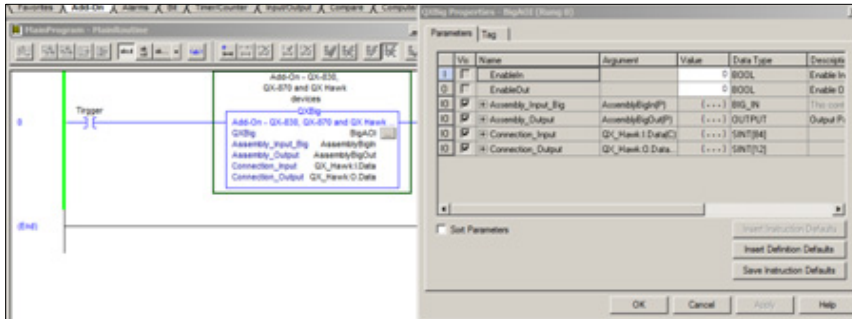

- Open the **Program Tags** dialog and trigger a read by changing the output tag from **0** to **1**.

Name	Value	Style	Data Type
AssemblyBigIn	{...}		BIG_IN
AssemblyBigOut	{...}		OUTPUT
AssemblyBigOut.UserDefTag	0	Decimal	DINT
AssemblyBigOut.Command	1	Decimal	DINT
AssemblyBigOut.ExternalOutCtrl	0	Decimal	DINT
BigAOI	{...}		QXBig
Trigger	1	Decimal	BOOL

- Expand the input assembly and verify that the read data has populated the tags.

Name	Value	Style	Data Type
[-] AssemblyBigIn	{ ... }		BIG_IN
[-] AssemblyBigIn.UserDefTagEcho	0	Decimal	DINT
[-] AssemblyBigIn.CommandEcho	1	Decimal	DINT
[-] AssemblyBigIn.OutputCtrlEcho	0	Decimal	DINT
[-] AssemblyBigIn.ExitInputStatus	0	Decimal	DINT
[-] AssemblyBigIn.ExitOutputStatus	0	Decimal	DINT
[-] AssemblyBigIn.DeviceStatus	0	Decimal	DINT
[-] AssemblyBigIn.ReadCylSeqCtr	6	Decimal	DINT
[-] AssemblyBigIn.ReadCylRptTrigCnt	6	Decimal	DINT
[-] AssemblyBigIn.ReadCylRptDecodCnt	6	Decimal	DINT
[-] AssemblyBigIn.ReadCylRptMismatchCnt	0	Decimal	DINT
[-] AssemblyBigIn.ReadCylRptNoreadCnt	0	Decimal	DINT
[-] AssemblyBigIn.String128	{ ... }		STRING128
[-] AssemblyBigIn.String128.LEN	12	Decimal	DINT
[-] AssemblyBigIn.String128.DATA	{ ... }	ASCII	SINT[128]
[-] AssemblyBigIn.String128.DATA[0]	*1*	ASCII	SINT
[-] AssemblyBigIn.String128.DATA[1]	*2*	ASCII	SINT
[-] AssemblyBigIn.String128.DATA[2]	*3*	ASCII	SINT
[-] AssemblyBigIn.String128.DATA[3]	*4*	ASCII	SINT
[-] AssemblyBigIn.String128.DATA[4]	*5*	ASCII	SINT
[-] AssemblyBigIn.String128.DATA[5]	*6*	ASCII	SINT
[-] AssemblyBigIn.String128.DATA[6]	*7*	ASCII	SINT
[-] AssemblyBigIn.String128.DATA[7]	*8*	ASCII	SINT
[-] AssemblyBigIn.String128.DATA[8]	*9*	ASCII	SINT
[-] AssemblyBigIn.String128.DATA[9]	*0*	ASCII	SINT
[-] AssemblyBigIn.String128.DATA[10]	*1*	ASCII	SINT
[-] AssemblyBigIn.String128.DATA[11]	*2*	ASCII	SINT
[-] AssemblyBigIn.String128.DATA[12]	*#00*	ASCII	SINT

- Below is a screen shot of the small input assembly data.

Name	Value	Style	Data Type
[-] AssemblySmallIn	{ ... }		SMALL_IN
[-] AssemblySmallIn.UserDefTagEcho	0	Decimal	DINT
[-] AssemblySmallIn.CommandEcho	1	Decimal	DINT
[-] AssemblySmallIn.OutputControlEcho	0	Decimal	DINT
[-] AssemblySmallIn.ReadCylSeqCtr	7	Decimal	DINT
[-] AssemblySmallIn.String64	{ ... }		STRING64
[-] AssemblySmallIn.String64.LEN	12	Decimal	DINT
[-] AssemblySmallIn.String64.DATA	{ ... }	ASCII	SINT[64]
[-] AssemblySmallIn.String64.DATA[0]	*1*	ASCII	SINT
[-] AssemblySmallIn.String64.DATA[1]	*2*	ASCII	SINT
[-] AssemblySmallIn.String64.DATA[2]	*3*	ASCII	SINT
[-] AssemblySmallIn.String64.DATA[3]	*4*	ASCII	SINT
[-] AssemblySmallIn.String64.DATA[4]	*5*	ASCII	SINT
[-] AssemblySmallIn.String64.DATA[5]	*6*	ASCII	SINT
[-] AssemblySmallIn.String64.DATA[6]	*7*	ASCII	SINT
[-] AssemblySmallIn.String64.DATA[7]	*8*	ASCII	SINT
[-] AssemblySmallIn.String64.DATA[8]	*9*	ASCII	SINT
[-] AssemblySmallIn.String64.DATA[9]	*0*	ASCII	SINT
[-] AssemblySmallIn.String64.DATA[10]	*1*	ASCII	SINT
[-] AssemblySmallIn.String64.DATA[11]	*2*	ASCII	SINT
[-] AssemblySmallIn.String64.DATA[12]	*#00*	ASCII	SINT
[-] AssemblySmallIn.String64.DATA[13]	*#00*	ASCII	SINT
[-] AssemblySmallIn.String64.DATA[14]	*#00*	ASCII	SINT
[-] AssemblySmallIn.String64.DATA[15]	*#00*	ASCII	SINT
[-] AssemblySmallIn.String64.DATA[16]	*#00*	ASCII	SINT
[-] AssemblySmallIn.String64.DATA[17]	*#00*	ASCII	SINT
[-] AssemblySmallIn.String64.DATA[18]	*#00*	ASCII	SINT
[-] AssemblySmallIn.String64.DATA[19]	*#00*	ASCII	SINT
[-] AssemblySmallIn.String64.DATA[20]	*#00*	ASCII	SINT

# Appendix L — EIPScan Setup

This procedure is for the EIPScan Test Tool published by Pyramid Solutions.

1. Right-click on “EIPScan Test Tool”, select “Add Device”:

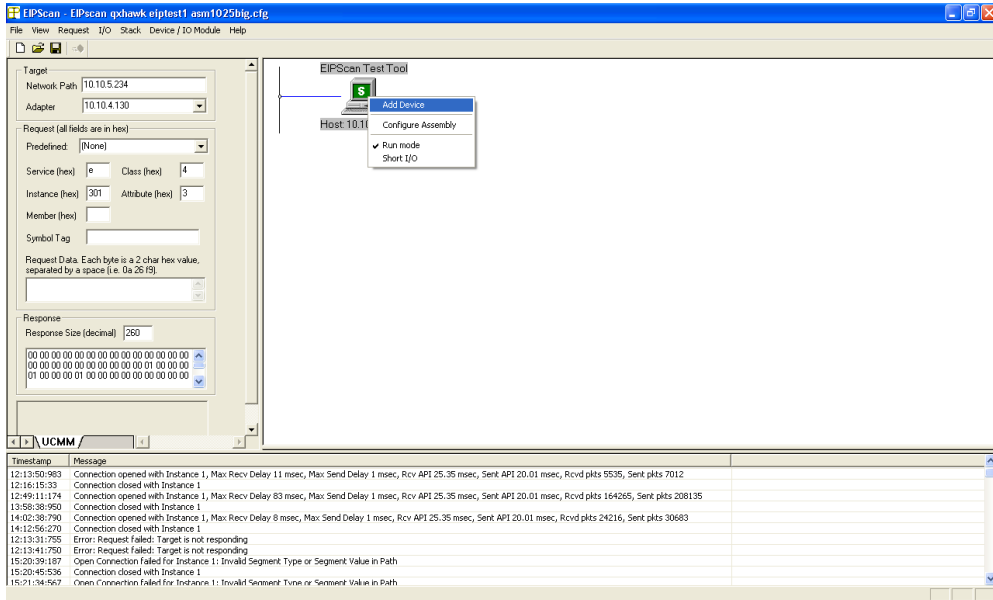

2. Set the “IP Address” to match QX Hawk:

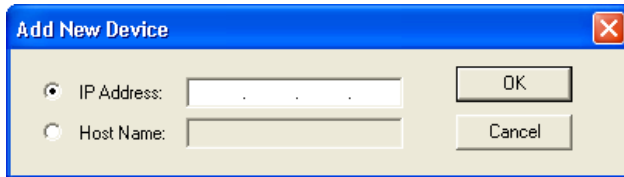

QX Hawk will show up in the main window:

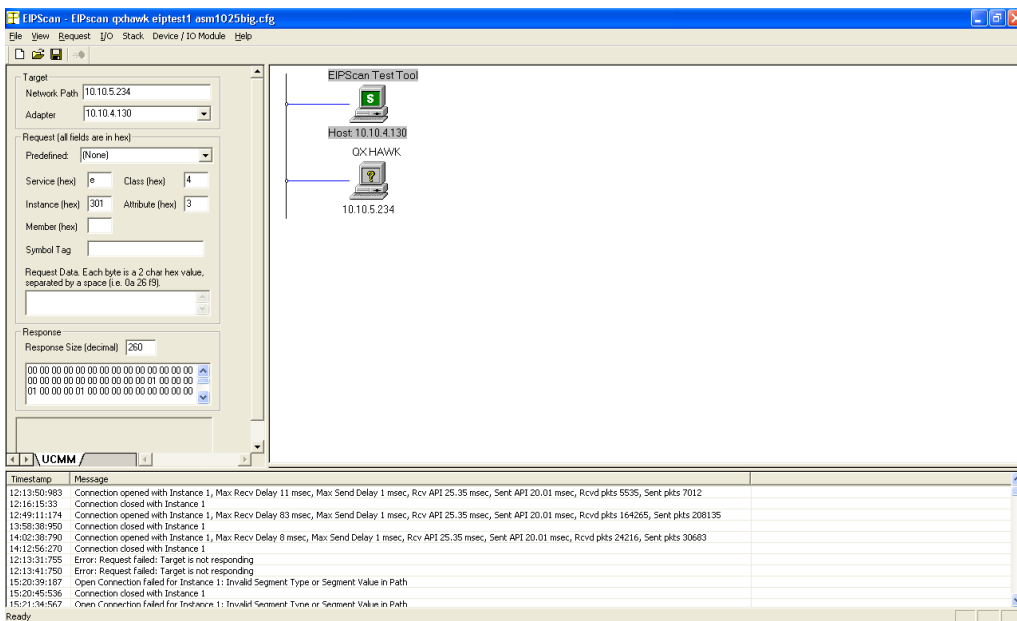

3. Right-click on QX Hawk, select “Add Class1 Connection”:

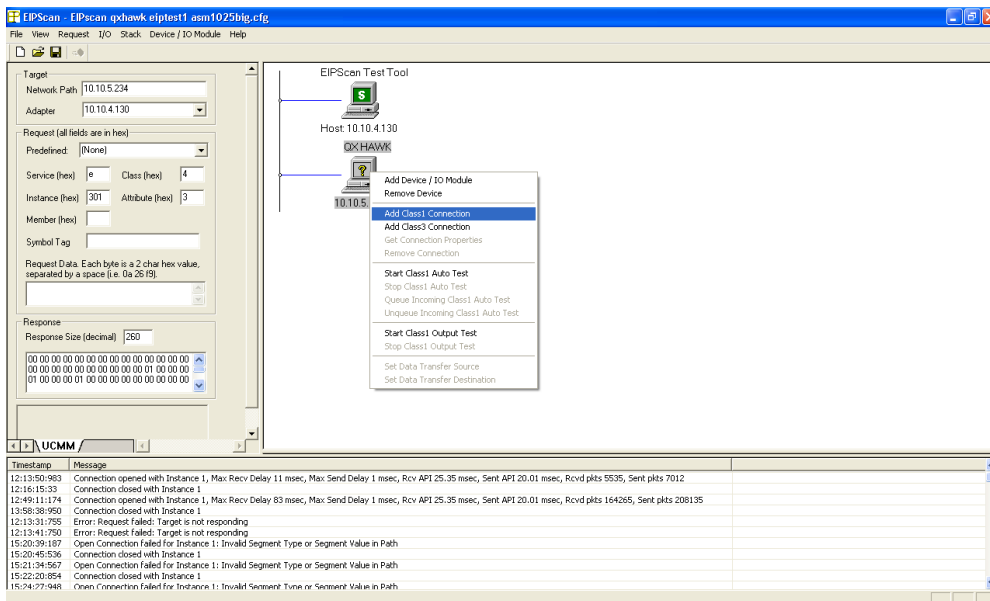

## EIPScan Setup

4. When the “Add Class1 Connection” dialog pops up, select “Data Size”.
5. Populate “Originator->Target” (OUT) with 12, and “Target->Originator” (Big IN) with 176:

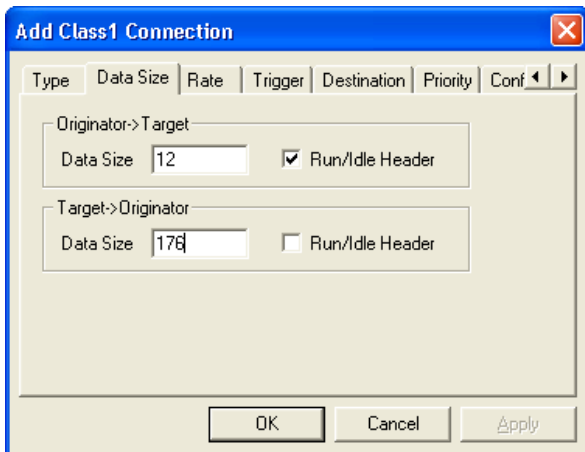

The screenshot shows the 'Add Class1 Connection' dialog box with the 'Data Size' tab selected. The 'Originator->Target' section has a 'Data Size' field set to 12 and a checked 'Run/Idle Header' checkbox. The 'Target->Originator' section has a 'Data Size' field set to 176 and an unchecked 'Run/Idle Header' checkbox. The 'OK', 'Cancel', and 'Apply' buttons are visible at the bottom.

Alternately, “Target->Originator” could be set to 84 for the Small IN assembly.

6. Select “Rate”, and set packet rate to 20 milliseconds in both directions:

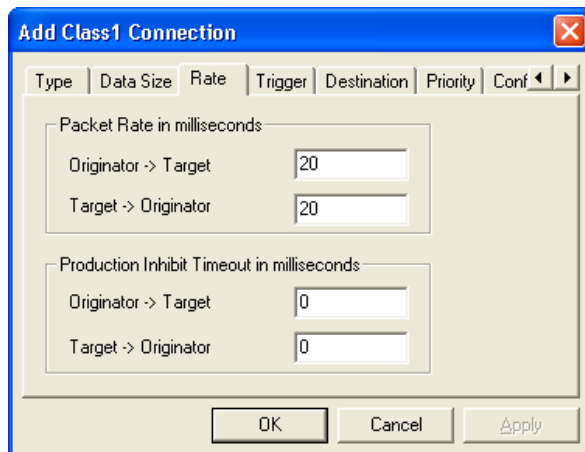

The screenshot shows the 'Add Class1 Connection' dialog box with the 'Rate' tab selected. The 'Packet Rate in milliseconds' section has 'Originator -> Target' and 'Target -> Originator' fields both set to 20. The 'Production Inhibit Timeout in milliseconds' section has 'Originator -> Target' and 'Target -> Originator' fields both set to 0. The 'OK', 'Cancel', and 'Apply' buttons are visible at the bottom.

7. Select “Destination”.
8. Populate “Originator->Target” (OUT) with 198, and “Target->Originator” (Big IN) 101:

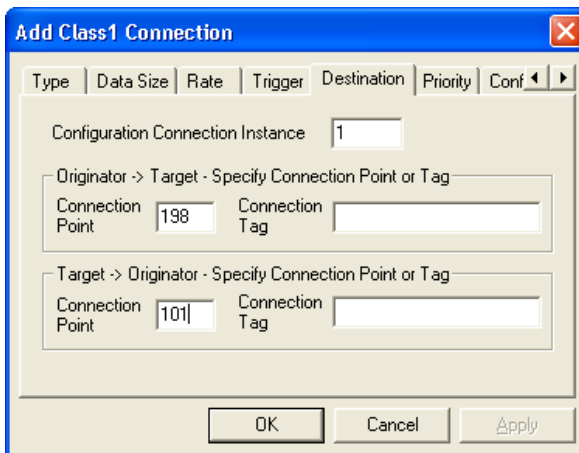

Alternately, “Target->Originator” could be set to 100 for the Small IN assembly.

9. Click OK, and the io data windows will show up in the main area, below QX Hawk.
10. In the I/O menu, select “Run mode” so that there is a check mark next to it:

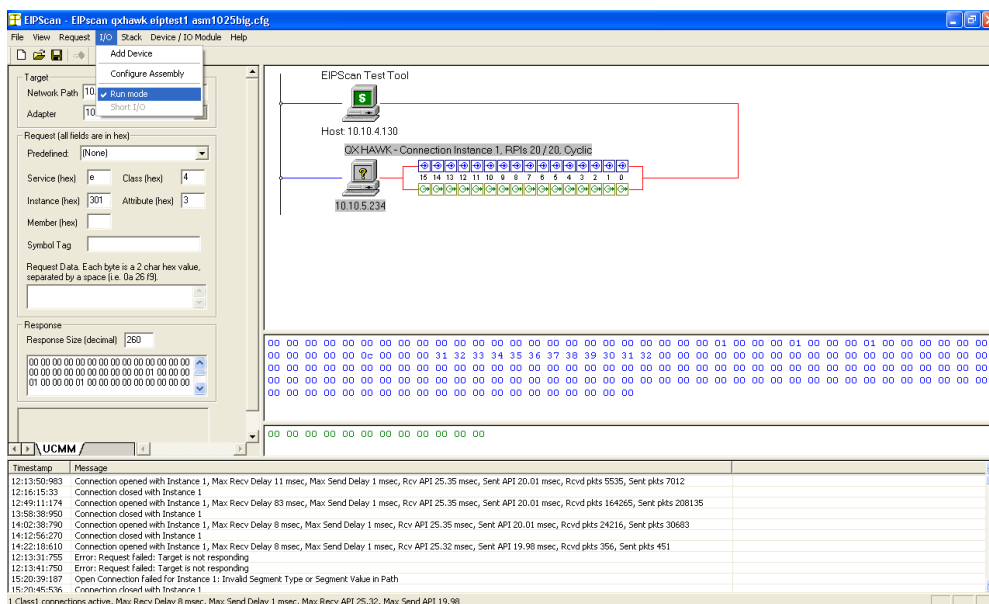

## EIPScan Setup

EIPScan begins polling the unit, and displays the content of the IN (blue) and OUT (green) assemblies:

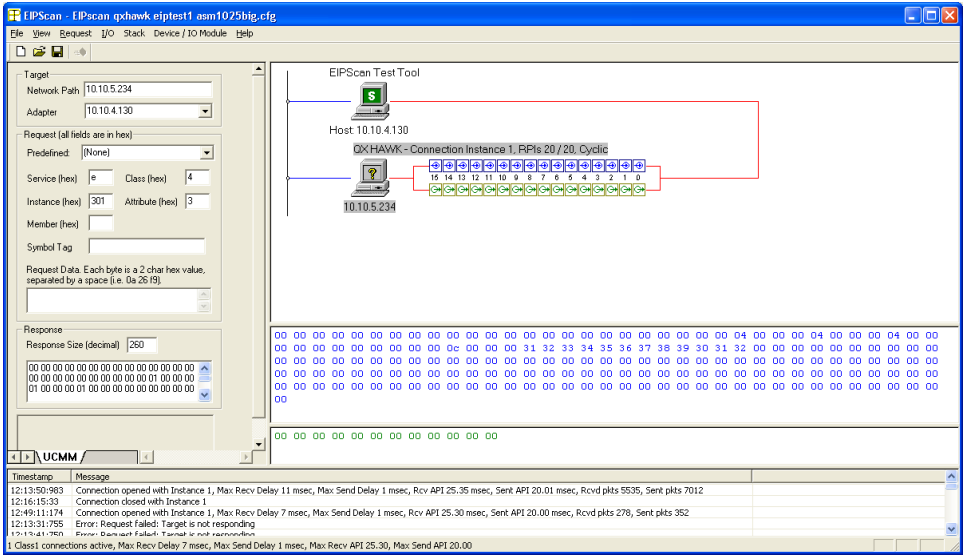

The order of data displayed in each assembly block corresponds to the object model documentation. For a quick test, we can simulate the PLC setting the “User Tag”, and QX Hawk echoing it back. 11. Click on the first byte (User Tag) in the green area (OUT):

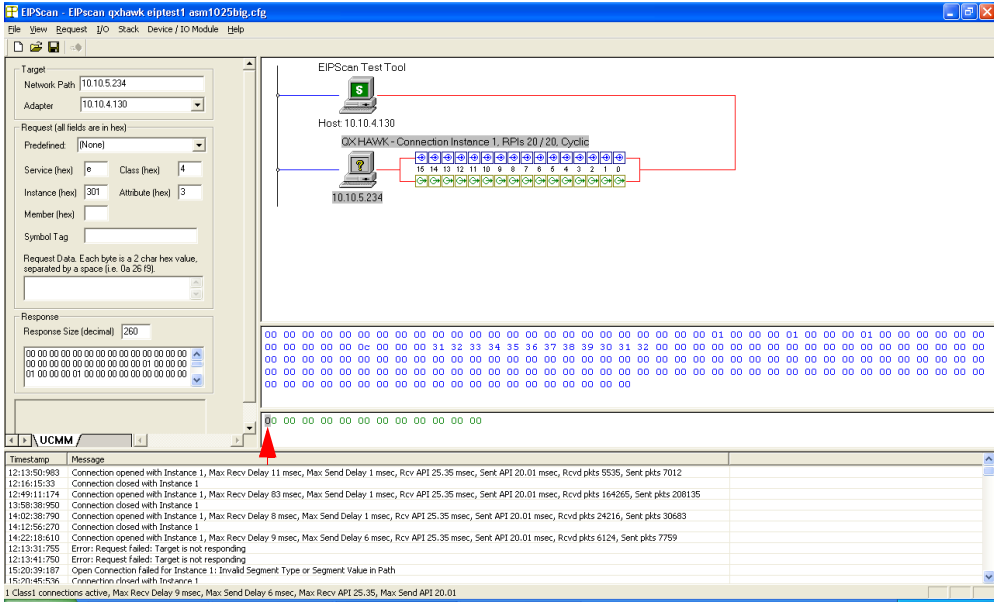



## 12. Change the first byte to non-zero. The first byte (User Tag echo) in the blue area (IN) will change to the same value:

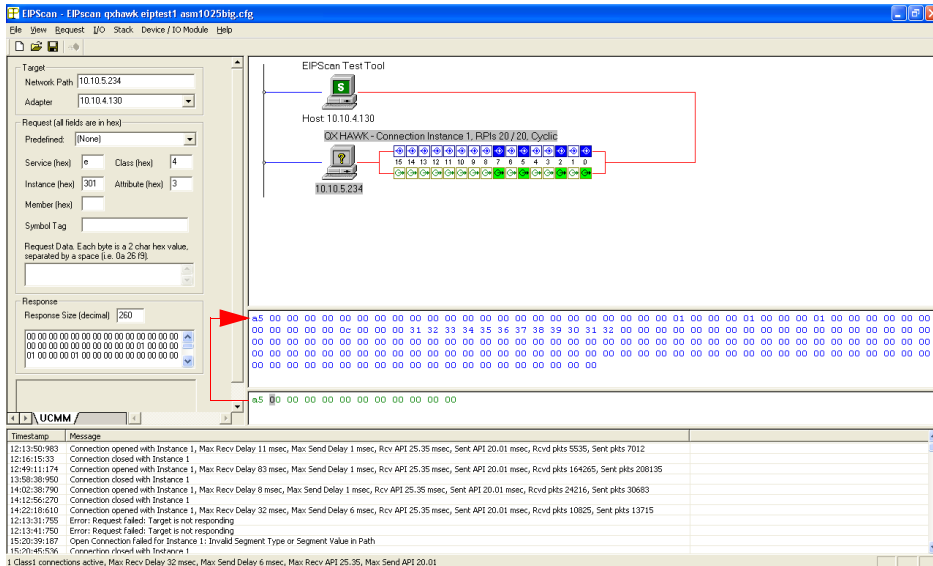

In fact, all bytes in the green OUT area will be echoed back in the blue IN area, at the same location relative to the beginning of the assemblies. Each byte, and bit, has a unique purpose. Please consult the object model for a description. Note that all data is displayed in little-endian order.

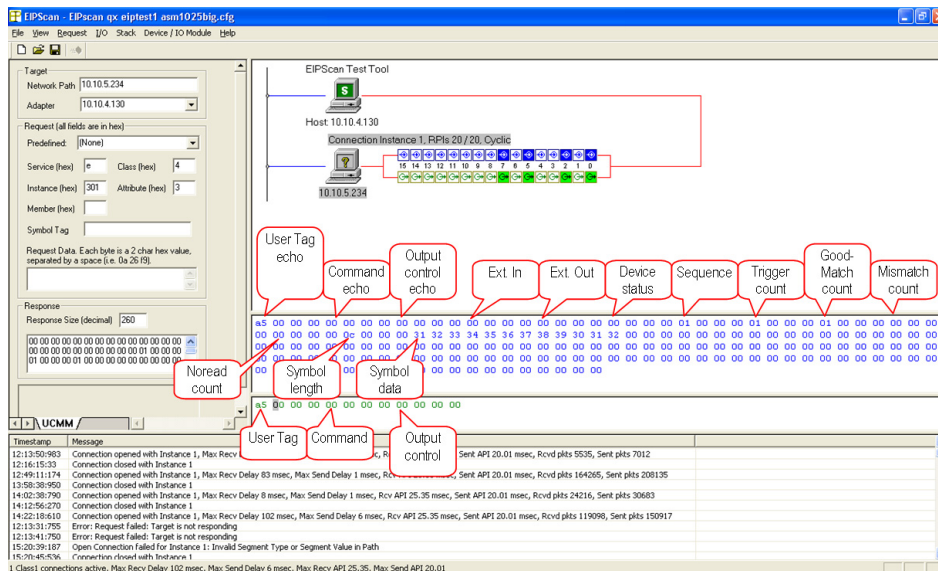

## **Appendix M — Interface Standards**

Interface Standards, established by the Electronic Industries Association (EIA), specify such things as the signaling voltage levels, maximum cable lengths, and number of drivers. In the QX Hawk, selection of interface is made by pin assignment and, in the case of host communication, by software switching between RS-232 and RS-422/RS-485.

### **RS-232**

RS-232 defines an interface between two devices such as, for example, the imager and host. It differs from the other interfaces by dedicating individual pins to specific functions and by requiring both devices to share a common ground line. Since both device chassis are connected to a common ground, a ground loop potential and the possibility of noise interference exists. Therefore cable lengths are limited to a maximum of 50 feet (19.7m). Despite being the most limited, this interface is used frequently because of the large installed base of RS-232 equipment.

### **RS-422/RS-485**

RS-422, unlike RS-232, measures signals differentially; that is, the receiver looks at the potentials between the two receive (or transmit) wires rather than the potential between signal and ground. As a result, cables, if shielded, can be up to 4000 feet (1219m) in length. Like RS-232, RS-422 communication is designed for only two devices on a single line and must have a common ground. It can be used wherever RS-232 is used.

### **Ethernet TCP/IP and EtherNet/IP**

TCP/IP and EtherNet/IP protocols are supported over Ethernet. A 6-byte hardware address is used, which is divided into a 3-byte vendor ID and a 3-byte vendor-defined field. Ethernet-enabled device manufacturers are assigned a unique vendor ID, and are then responsible for insuring that all of their devices have unique addresses in the last 3 bytes.

## Appendix N — Glossary of Terms

**Aberration** — The failure of an optical lens to produce an exact point-to-point correspondence between the object and its resulting image. Various types are chromatic, spherical, coma, astigmatism and distortion.

**Absorption** — The loss of light of certain wavelengths as it passes through a material and is converted to heat or other forms of energy. (–)

**Active Illumination** — Lighting an area with a light source coordinated with the acquisition of an image. Strobed flash tubes and pulsed lasers are examples.

**ADC** — See **Analog-to-Digital Converter**.

**A/D Converter** — See **Analog-to-Digital Converter**.

**AGC** — See **Automatic Gain Control**.

**Ambient Light** — Light which is present in the environment of the imaging front end of a vision system and generated from outside sources. This light, unless used for actual illumination, will be treated as background **Noise** by the vision system.

**Analog** — A smooth, continuous voltage or current signal or function whose magnitude (value) is the information.

**Analog-to-Digital Converter (A/D Converter or ADC)** — A device that converts an analog voltage or current signal to a discrete series of digitally encoded numbers (signal) for computer processing.

**Application-Specific Integrated Circuit (ASIC)** — An integrated circuit that is customized for a particular kind of use, rather than general use. All vision system elements including firmware can be integrated into one ASIC.

**Architecture** — The hardware organization of a vision system designed for high speed image analysis.

**ASIC** — See **Application-Specific Integrated Circuit**.

**Aspect Ratio** — The ratio between the height and width of a sensor or display. Found by dividing the vertical number of pixels (height) by the horizontal number of pixels (width) leaving it in fractional format.

**Automatic Gain Control (AGC)** — Adjustment to signal strength that seeks to maintain a constant level regardless of the distance between a reader and symbol.

**Auxiliary Port** — RS-232 connection to an auxiliary terminal or device for remote viewing.

**Blooming** — A situation in which too many photons are being produced to be received by a pixel. The pixel overflows and causes the photons to go to adjacent pixels. Blooming is similar to overexposure in film photography, except that in digital imaging, the result is a number of vertical and/or horizontal streaks appearing from the light source in the picture.

**Baud Rate** — The number of discrete signal events per second; bits per second.

**Capture** — The act of acquiring and storing video images in an imager or host computer. Also, the image captured.

**CCD** — See **Charge-Coupled Device**.

**Charge-Coupled Device (CCD)** — A semiconductor device with an array of light-sensitive elements that converts light images into electrical signals.

**Check Character** — A Modulus 43 or Modulus 10 character that is added to encoded symbol data for additional data integrity.

**CMOS** — See **Complementary Metal Oxide Semiconductor**.

**Complementary Metal Oxide Semiconductor (CMOS)** — Like CCDs, CMOS imagers include an array of photo-sensitive diodes, one diode within each pixel. Unlike CCDs, however, each pixel in a CMOS imager has its own individual amplifier integrated inside.

**Connector** — A plug or socket on a device or cable providing in/out connectivity for various circuits and pins.

**Concentrator** — Intermediary device that relays data from imagers to a host and commands from the host to the imagers or other devices.

**Counter** — Memory space allocated to keep track of imager events.

**DAC** — See **Digital-to-Analog Converter**.

**Daisy Chain** — Linkage of primary and secondary imagers allowing data to be relayed up to the host via auxiliary port connections.

**Decode** — A **Good Read**. The successful interpretation and output of the information encoded in a symbol.

**Default** — Restores **ROM** or flash settings, initializes serial commands and resets all counters.

**Delimited** — A delimited command or field is bracketed by predefined characters.

**Decode Rate** — The number of good reads per second achieved by an imager.

**Dark Field Illumination** — Lighting of objects, surfaces, or particles at very shallow or low angles, so that light does not directly enter a reader's optical hardware.

**Depth-of-Field** — The in-focus range of an imaging system. Measured from the distance behind an object to the distance in front of the object with all objects appearing in focus.

**Diffused Lighting** — Scattered soft lighting from a wide variety of angles used to eliminate shadows and specular glints from profiled, highly reflective surfaces.

**Digital-to-Analog Converter (DAC)** — A **VLSI** circuit used to convert digitally processed images to analog for display on a monitor.

**Digital Imaging** — Conversion of an image into pixels by means of an **Analog-to-Digital Converter** where the level of each pixel can be stored digitally.

**Digital Signal Processor (DSP)** — A **VLSI** chip designed for ultra-high-speed arithmetic processing. Often imbedded in a vision engine.

**Discrete I/O** — Inputs and outputs characterized by discrete signal transitions from one voltage level to another so that digital switching can occur.

**Direct Memory Access (DMA)** — A capability provided by some computer bus architectures that allows data to be sent directly to memory from an attached device.

**DMA** — See **Direct Memory Access**.

**DSP** — See **Digital Signal Processor**.

**Dynamic Range** — The difference between the minimum and maximum thresholds of discernible images; the amount of usable signal.

**Edge Enhancement** — Image processing method to strengthen high-spatial frequencies in the image.

**EPROM** — See **Erasable Programmable Read-Only Memory**.

- Embedded Memory** — Onboard memory device such as **EPROM** or flash.
- End of Read Cycle** — The time or condition at which the imager stops expecting symbol information to decode.
- Erasable Programmable Read-Only Memory (EPROM)** — A memory chip that retains data when its power supply is turned off; “non-volatile memory”.
- External Edge** — Allows a read cycle to be initiated by a trigger signal from an object detector when it detects the appearance of an object (rising edge). The read cycle ends with a good read, a timeout, or a new trigger.
- External Level** — Allows a read cycle to be initiated by a trigger signal from an object detector. The read cycle ends when the object moves out of the detector’s range.
- Falling Edge** — A change of state (to inactive) associated with a level trigger.
- Field-Programmable Gate Array (FPGA)** — A semiconductor device containing programmable interconnects and logic components.
- Fill Factor** — Percentage of pixel area used for light collection.
- Firmware** — Software hard-coded in non-volatile memory (**ROM**), and closely tied to specific pieces of hardware.
- Fixed Symbol Length** — Increases data integrity by ensuring that only one symbol length will be accepted.
- Focal Distance** — In camera-based vision, the distance from the front of the camera to the object being viewed. (In optics, the distance from the lens to the focal plane.)
- Focal Plane** — Usually found at the image sensor, it is a plane perpendicular to the lens axis at the point of focus (–).
- Focus** — Any given point in an image at which light converges; the focal point.
- FPGA** — See **Field-Programmable Gate Array**.
- Frame** — The total area captured in an image sensor while the video signal is not blanked.
- Frame Grabber** — A device that interfaces with a camera and, on command, samples the video, converts the sample to a digital value and stores that in a computer's memory.
- Front End System** — The object, illumination, optics and imager blocks of a vision system. Includes all components useful to acquire a good image for subsequent processing.
- Full Duplex** — A communications system in which signals can travel simultaneously between devices.
- Gain** — The amount of energy applied to pixel gray scale values prior to output, expressed in dB; optimal signal strength.
- Good Read** — A decode. The successful scanning and decoding of the information encoded in a bar code symbol.
- Gradient** — The rate of change of pixel intensity (first derivative).
- Gray Scale** — Variations of values from white, through shades of gray, to black in a digitized image with black assigned the value of zero and white the value of one.
- Half Duplex** — A communications system in which signals can travel between devices in both directions, but not simultaneously.
- Histogram** — A graphical representation of the frequency of occurrence of each intensity or range of intensities (gray levels) of pixels in an image. The height represents the number of observations occurring in each interval.

---

## Glossary of Terms

**Host** — A computer, **PLC**, or other device that is used to execute commands and process data and discrete signals.

**Image** — Projection of an object or scene onto a plane (i.e. screen or image sensor).

**Image Processing (IP)** — Transformation of an input image into an output image with desired properties.

**Image Resolution** — The number of rows and columns of pixels in an image. A higher resolution means that more pixels are available per element of the symbol being read. Examples: 640 x 480 (VGA); 854 x 480 (WVGA); 1280 x 1024 (SXGA); 2048 x 1536 (QXGA).

**Image Sensor** — A device that converts a visual image to an electrical signal; a **CCD** or **CMOS** array.

**Initialize** — Implement serial configuration commands into the imager's active memory.

**Input** — A channel or communications line. Decoded data or a discrete signal that is received by a device.

**Integration** — Exposure of pixels on a **CMOS** sensor.

**IP** — See **Image Processing**.

**Ladder Orientation** — A linear symbol orientation in which the bars are parallel to the symbol's direction of travel.

**LED** — See **Light-Emitting Diode**.

**Light-Emitting Diode (LED)** — A semiconductor device that emits light when conducting current.

**Lens** — A transparent piece of material with curved surfaces which either converge or diverge light rays.

**Machine Vision** — The automatic acquisition and analysis of images to obtain desired data for controlling a specific activity.

**Multidrop** — A communications protocol for networking two or more imagers or other devices with a concentrator (or controller) and characterized by the use of individual device addresses and the RS-485 standard.

**Noise** — The same as static in a phone line or "snow" in a television picture, noise is any unwanted electrical signal that interferes with the image being read and transferred by the imager.

**Normally Closed** — A discrete output state that is only active when open.

**Normally Open** — A discrete output state that is only active when closed.

**Object Plane** — An imaginary plane in the field of view, focused by an imager's optical system at the corresponding image plane on the sensor.

**Output** — A channel or communications line. Data or discrete signals that are transmitted or displayed by a device.

**Parity** — An error detection routine in which one data bit in each character is set to **1** or **0** so that the total number of **1** bits in the data field is even or odd.

**Picket Fence Orientation** — A linear symbol orientation in which the bars are perpendicular to the symbol's direction of travel.

**Pitch** — Rotation of a linear or 2D symbol around an axis parallel to the symbol length on the **Substrate**.

**Pixel** — An individual element in a digitized image array; “picture element”.

**PLC** — See **Programmable Logic Controller**.

**Port** — Logical circuit for data entry and exit. (One or more ports may be included within a single connector.)

**Processing Time** — The time used by a vision system to receive, analyze and interpret image information. Often expressed in “parts per minute”.

**Programmable Logic Controller (PLC)** — An electronic device used in industrial automation environments such as factory assembly lines and automotive manufacturing facilities.

**Progressive Scan** — A non-interlaced scan that doubles the number of visible picture lines per field by displaying all picture lines at once.

**Protocol** — The rules for communication between devices, providing a means to control the orderly flow of information between linked devices.

**RAM** — See **Random Access Memory**.

**Random Access Memory (RAM)** — A data storage system used in computers, composed of integrated circuits that allow access to stored data in any sequence without movement of physical parts.

**Read Cycle** — A programmed period of time or condition during which a reader will accept symbol input.

**Read-Only Memory (ROM)** — A data storage medium used in computers and other electronics, primarily used to distribute **Firmware**.

**Real-Time Processing** — In machine vision, the ability of a system to perform a complete analysis and take action on one part before the next one arrives for inspection.

**Region** — Area of an image. Also called a region of interest for image processing operations.

**ROM** — See **Read-Only Memory**.

**Saturation** — The degree to which a color is free of white. One of the three properties of color perception, along with hue and value.

**Scattering** — Redirection of light reflecting off a surface or through an object.

**Skew** — Rotation of a linear or 2D symbol around an axis parallel to the symbol height on the substrate.

**Substrate** — The surface upon which a linear or 2D symbol is printed, stamped, or etched.

**Symbol Transitions** — The transition of bars and spaces on a symbol, used to detect the presence of a symbol on an object.

**Symbology** — A symbol type, such as Code 39 or Code 128, with special rules to define the widths and positions of bars and spaces to represent specific numeric or alphanumeric information.

**Tilt** — Rotation of a linear or 2D symbol around an axis perpendicular to the substrate.

**Trigger** — A signal, transition, or character string that initiates a read cycle.

**Very Large-Scale Integration (VLSI)** — The creation of integrated circuits by combining thousands of transistor-based circuits on a single chip.

**Watchdog Timer** — A security device that detects system crashes and attempts to reset the imager.

