



Getting Started with the UID Compliance Verifier

v2.3.1

Copyright and Disclaimer

Copyright ©2015 by Microscan Systems, Inc.

700 S.W. 39th Street, Renton, WA, U.S.A. 98057
(425) 226-5700 FAX: (425) 226-8682

All rights reserved. The information contained herein is proprietary and is provided solely for the purpose of allowing customers to operate and/or service Microscan manufactured equipment and is not to be released, reproduced, or used for any other purpose without written permission of Microscan.

Throughout this manual, trademarked names might be used. Rather than place a trademark (™) symbol at every occurrence of a trademarked name, we state herein that we are using the names only in an editorial fashion, and to the benefit of the trademark owner, with no intention of infringement.

Disclaimer

The information and specifications described in this manual are subject to change without notice.

Latest Manual Version and Warranty Information

For the latest version of this manual and warranty information, visit our website at: www.microscan.com.

Technical Support

For technical support, email: helpdesk@microscan.com.

Microscan Systems, Inc.

Tel: 425 226 5700

Fax: 425 226 8250

helpdesk@microscan.com

Microscan Europe

Tel: 31 172 423360

Fax: 31 172 423366

Microscan Asia Pacific

R.O. Tel: 65 6846 1214

Fax: 65 6846 4641

Contents

PREFACE	Welcome!	xi
	Purpose of This Manual	xi
	Product Specification	xii
	UID Standards Compatibility Chart	xiii
	UID Topics – Where to Learn More on the Web	xiii
	Manual Conventions	xiv
CHAPTER 1	Getting Started w/UID Compliance Verifier	1-1
	Overview of UID Compliance Verifier, LDP (UID-LDP)	1-2
	Overview of UID Compliance Verifier, DPM (UID-DPM)	1-3
	Portable Operation	1-5
	Components — UID-LDP	1-6
	Components — UID-DPM	1-6
	UID-LDP & UID-DPM Operating Environment	1-7
	Choosing a PC	1-7
	Installing Optional Long Feet Spacers	1-7
	Powering Up the UID-LDP & UID-DPM	1-9
	Loading the Software	1-9
	Networking to the UID-LDP & UID-DPM	1-10
	DHCP and Static IP Addresses Explained	1-12
	Upgrading the UIDChecker™ Software from V2.1	1-13

Lighting for the UID-LDP & UID-DPM **1-15**
 Light Configurations 1-16
 Positioning Data Matrix Mark for Verification 1-17
 Light Control 1-17
 Triggers 1-18

CHAPTER 2 **Quickly Using UID Compliance Verifier 2-1**

Using Your UIDChecker™ Software **2-1**
 First Time Startup 2-1
 Subsequent Startups 2-3
Testing the UID Compliance Verifier **2-3**
 Perform Reflectance Calibration 2-3
 Test the Correct Calibration 2-5
 Test the Correct Operation 2-8

CHAPTER 3 **UIDChecker™ Application Details 3-1**

File Naming Scheme **3-1**
Secured UID Verifier **3-2**
UIDChecker™ User Interface Overview **3-2**
 UID Read & Graphical Display Details 3-3
 Image 3-3
 Validation Text Result 3-3
 Verification Text Result 3-4
 UID Mark Read Result/Status 3-4
 Light Indicators 3-4
 Text Box for UI Only Validation 3-4
 Text Box for CPN/LBN Only Validation 3-5
 Text Box for Validating UI & CPN/LBN in a Single Symbol 3-6
UIDChecker™ Buttons Overview **3-7**
 Live Video 3-7
 Read And Rotate 3-8
 Read UID Mark 3-8
 Analyzing the Results of UID Compliance Check 3-8
 View Result 3-9
 Print Result 3-9
 Save Result 3-9

Main Menu Items 3-10

- File 3-10
 - Exit 3-10
- Reader 3-10
 - Find a Reader 3-10
 - Turn Laser Off 3-13
 - Calibrate 3-13
 - Lighting & Exposure 3-16
 - Verification Type 3-18
- Define Customer Fields 3-21
- Results Setup 3-22
 - Automatically Save the Result with Each Read 3-23
 - Store Images With Results 3-23
 - Convert Image to JPG 3-23
 - Show Verification Details in On-Screen Results View 3-23
 - Show Decoded Data Above Image 3-23
 - Store Results in MDB Database and CSV File 3-23
 - Variance to Override Cell Size Restrictions 3-25
 - Enable CPN/LBN Support 3-26
 - Change Results Path 3-27
 - Clear Log View 3-27
 - Close 3-28
- View Results 3-28
 - View Tab 3-30
 - Search Tab 3-32
 - Archive Tab 3-34
- About 3-36

UIDChecker™ UID Mark Validation Error Messages 3-37

UIDChecker™ Data Matrix Verification Error Messages 3-39

CHAPTER 4 UID Read Result Data Details 4-1

- Analyzing the Results of UIDChecker™ 4-1
- UID Results Data File 4-6
 - Version 2.3 UIDDataLog_2.3.0.csv File Format 4-7
 - Version 2.3 DataBase Table Layout 4-7
- Understanding UID Mark Quality 4-11
 - Data Matrix Cell Size 4-11
 - ECC 200 4-11
 - Data Matrix Quality Verification Standard 4-11

Contents

APPENDIX A	Upgrading to UIDChecker™ V2.1	A-1
APPENDIX B	Read And Rotate	B-1
	Read And Rotate Usage Details	B-1
APPENDIX C	Attaching UID-DPM to UID-DPM Stand	C-1
	Setting Up the UID-DPM Stand	C-1
	Attaching the UID-DPM	C-2
APPENDIX D	Upgrading UID-DPM001 w/UIDChecker Software V2.3	D-1
	Setting Up the UID-DPM Stand	D-2
	Attaching the Camera	D-2
	Assembling the Lights	D-3
	Preparing the Lenses	D-3
	Attaching the Lights to the Camera	D-4
	Recommended Verifier Setting with 25mm Lens	D-5
	Recommended Verifier Setting with 35mm Lens	D-7
	Setting Up the Network	D-9
	Upgrading the Software	D-9
	Configuring the Verifier	D-9
	HawkEye Sensor/Lighting Normalization	D-10
	Reflectance Calibration	D-12
APPENDIX E	Fixing ADO Components Error	E-1
APPENDIX F	Data File Formats for UIDChecker Software	F-1
	Version 1.0 UIDDataLog.Dat File Format	F-1
	Version 2.0 UIDDataLog.Dat File Format	F-4
	Version 2.1 UIDDataLog.csv File Format	F-10

Version 2.1 DataBase Table Layout **F-11**

Version 2.2 DataBase Table Layout **F-14**

APPENDIX G **Certification & Specifications** **G-1**

CE Compliance **G-1**

FCC Statement **G-2**

FDA Statement **G-2**

Specifications **G-3**

 UID-LDP G-3

 Physical Characteristics G-3

 Performance Characteristics G-3

 User Environment G-3

 UID-DPM G-4

 Physical Characteristics G-4

 Performance Characteristics G-4

 User Environment G-4

Index **Index-1**

Contents

Welcome!

Purpose of This Manual

The purpose of this manual is to get you up and running with your UID Compliance Verifier quickly and confidently. The manual covers the following two products:

- UID Compliance Verifier, LDP, for labels and data plates (UID-LDP)
- UID Compliance Verifier, DPM, for direct part marks (UID-DPM)

Product Specification

The following table is a product specification of the UID Compliance Verifier.

TABLE 1. Product Specification

Item	Description as Implemented
Hardware	HE1525HDU for UID-LDP, HE1510 for UID-DPM; Customer's Windows 2000, Windows XP, or Windows Vista Business PC
Target	Reading, verifying and validating Unique Identification (UID) marks. UID Marks are Data Matrix Codes
Symbology Type	The UID Compliance Verifier verifies the Data Matrix Symbology type ECC 200
Measuring apertures or effective resolution available	Aperture 05 is used for MIL-STD-130L and MIL-STD-130M Aperture is determined by the AIM DPM verification algorithm in MIL-STD-130M/Change 1 and MIL-STD-130N
Overall Sizes of Symbols	UID-LDP:0.075" - 0.6" UID-DPM:0.075" - 0.8"
Specification of illumination source	640 +/- 20 nm
Means of Reflectance calibration	Two calibration points are used. A calibration sample with NIST traceable 80% contrast calibrates the high reflectance end of the range. The sensor's black level is calibrated to be the low reflectance of the range.
Means of Reporting and recording verification results	A comma-delimited file contains the record data; HTML files contain the verification results including images; on screen results reported real-time. An Access database stores information in a format that can be queried.
Optional Functions performed	Ability to add a customer's graphics to the reports.
Ability to average results from repeated scans	The UID Compliance Verifier averages five scans in different orientations per MIL-STD-130L (ISO/IEC 15415) when selected.
Interfacing capabilities	The verification results are reported to the PC as html files, which can be viewed using Internet Explorer. UIDChecker™ supports data logging, archival and printing. Reports can be created by querying the results database.
Programming and Configuration	The UID Compliance Verifier is programmed upon hardware startup to default settings via the PC over ethernet. UIDChecker™ supports data logging, archival and printing

UID Standards Compatibility Chart

This version of UIDChecker™ software is compliant with the following:

TABLE 2. UID Compatibility Chart

Standard	Release Date
DFARS 252.211-7003	April 22, 2005
ISO/IEC 15415	June 15, 2004
ISO/IEC 15418	December 1, 1999
ISO/IEC 15434	October 1, 1999
ISO/IEC 16022	May 1, 2000
MIL-STD-130L	Pre- and Post- December 20, 2004
MIL-STD-130L, Change 1	December 21, 2004
MIL-STD-130M	December 2, 2005
SAE AS9132	February 15, 2005
AIM DPM-1-2006	December 12, 2006
MIL-STD-130M Change 1	June 15, 2007
MIL-STD-130N	December 17, 2007

Manual Conventions

The following typographical conventions are used throughout this manual.

- Items emphasizing important information is **bolded**.
- Menu selections, menu items and entries in screen images are indicated as: Run (triggered), Modify..., etc.



Indicates Class II laser radiation.

Getting Started w/UID Compliance Verifier

This guide provides information you need to quickly set up and use the following Microscan UID Compliance Verifier products:

- UID Compliance Verifier, LDP, for labels and data plates
- UID Compliance Verifier, DPM, for direct part marks

Full product details can be found in the latter chapters of this manual.

Overview of UID Compliance Verifier, LDP (UID-LDP)

FIGURE 1-1. UID-LDP



The UID Compliance Verifier, LDP (UID-LDP) is designed for labels and data plates containing UID Data Matrix marks with thicknesses up to 1/8 inches (3.2 mm). The Diffuse Perpendicular (90) lighting allows the bottom of the light to be more than 1.5 inches from the mark for ease of use. The laser targeting aids in placing the mark in the center of the camera's field of view (FOV). The FOV is 1.0 inches x 0.75 inches (25.4 mm x 19.0 mm). The maximum supported Data Matrix size is 0.6 inches (15 mm). This size allows either a Data Matrix of:

- 24-row by 24-column using X dimension of 25 mil (0.025 inches) element size
- Higher density using X dimension of 7.5 mil (0.0075 inches) element size

Overview of UID Compliance Verifier, DPM (UID-DPM)

FIGURE 1-2. UID-DPM for Label and Data Plate



The UID Compliance Verifier, DPM, (UID-DPM) is designed for UID Data Matrix direct part marks with varying thicknesses and shapes. It provides all the lighting options specified in AIM DPM-1-2006:

- Medium Angle Four Direction (45Q)
- Low Angle Four Direction (30Q)
- Low Angle Two Direction (30T)
- Low Angle Single Direction (30S)
- Diffuse Perpendicular (90)
- Diffuse Off Axis (D)

The FOV is 1.19 inches x 0.86 inches (30.2 mm x 21.8 mm). The maximum Data Matrix size that can be supported is 0.8 inches (20 mm). This size allows a 32-row by 32-column Data Matrix using X dimension of 25 mil (0.025 inches) or a Data Matrix of higher density with X dimension as small as .75 mil (0.0075 inches).

To read Data Matrix labels and data plates up to 1/8 inches (3.2mm), the UID-DPM can be placed on the four standard feet that measure 0.875 inches (22 mm) long.

The UID-DPM can be mounted on the UID Verifier stand (see Appendix C, “Attaching UID-DPM to UID-DPM Stand,”) for reading Data Matrix labels, data plate, and DPM. The surface of the Data Matrix must be at the correct distance measurable using one of the standard feet.

FIGURE 1-3. UID-DPM for Verifying DPM



Measuring Distance Using Foot



Verifying

Portable Operation

The UID-DPM supports limited portable operation using the standard feet. Simply hold it against a large flat part and press any one of the three trigger buttons, as shown in Figure 1–4.



Caution

Please be very careful when using the unit in this manner, and avoid dropping it.

FIGURE 1–4. UID-DPM for Portable Operation

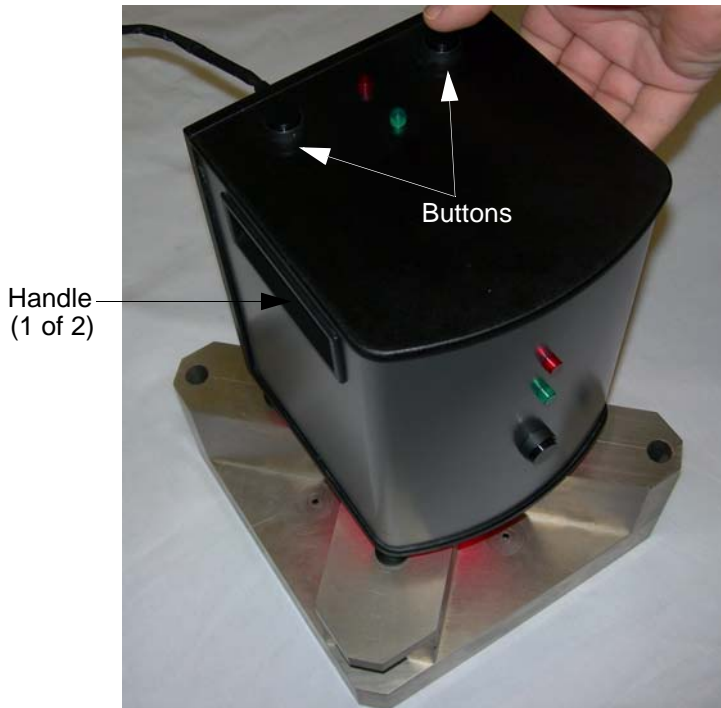

Components — UID-LDP

- UID-LDP Bench Top Verifier (FIS-UD20-0CK1)
- UID-LDP Power Supply (933-0113-1)
- Ethernet network cable (HEENET-007)
- UID Compliance Card to test your UID-LDP (A4-20814-1A)
- UIDChecker™ Software Installer (Microscan Tools Drive: 37-000010-01)
- Calibration Test Card (98-UA10-0CC0)
- Ethernet Cross Link Adapter (HEENET-XLA)
- Serial Communications Cable (HESC-006) {Hardware rescue aid only}
- This Getting Started guide

Components — UID-DPM

- UID-DPM Verifier with Multifunction Light (FIS-UD10-0DP1)
- UID-DPM Standard Presentation Feet
- UID-DPM Optional Long Feet Spacers
- UID-DPM Power Supply (A1-40346-1)
- Ethernet network cable (HEENET-007)
- UID Compliance Card to test your UID-DPM (A4-20814-1A)
- UIDChecker™ Software Installer (Microscan Tools Drive: 37-000010-01)
- Calibration Card (98-UA10-0CC0)
- Ethernet Cross Link Adapter (HEENET-XLA)
- Serial Communications Cable (HESC-006) {Hardware rescue aid only}
- This Getting Started guide

UID-LDP & UID-DPM Operating Environment

- Operating Temperature: 32°F to 104°F (0°C to 40°C)
- Storage Temperature: 122°F (50°C) Max

Choosing a PC

The UID-LDP and UID-DPM systems require you to supply a PC running Microsoft Windows 2000, Windows XP, or Windows Vista Business with:

- Administrator privileges
- At least a 2 GHz CPU
- At least 512M RAM
- A CD-ROM drive
- At least 100 Mb of available hard disk space
- A 10/100 Mb Network (Ethernet) Interface
- Display capable of displaying at least 1024 by 768 pixels, true colors

Note: In some installations, you will need two network ports: one for your PC and one for the UID-LDP or UID-DPM. For more information, see “Networking to the UID-LDP & UID-DPM” on page 1-10.

Installing Optional Long Feet Spacers

For UID-DPM, the feet with standard spacers are installed at the factory to provide the normal stand-off distance of 7/8 inch (22.2 mm). You can lengthen the feet using the optional spacers.

- For labels and data plates with thicknesses up to 1/8 inches (3.2 mm), use the standard spacers.
- For DPM parts with thicknesses up to 5/8 inches (15.9 mm), replace the standard spacers with the optional long spacers.

- For DPM parts with thicknesses up to 15/16 inches (23.8 mm), add the optional long spacers to the standard spacers.

Note: You need to make sure that the mark surface of the DPM part is approximately 7/8 inches (22.2 mm) from the bottom of the plate.

To install the optional long feet spacer, or to re-install the standard feet, follow Figure 1–5.

FIGURE 1–5. Installing the Feet on the UID-DPM (Standard Spacers Shown)

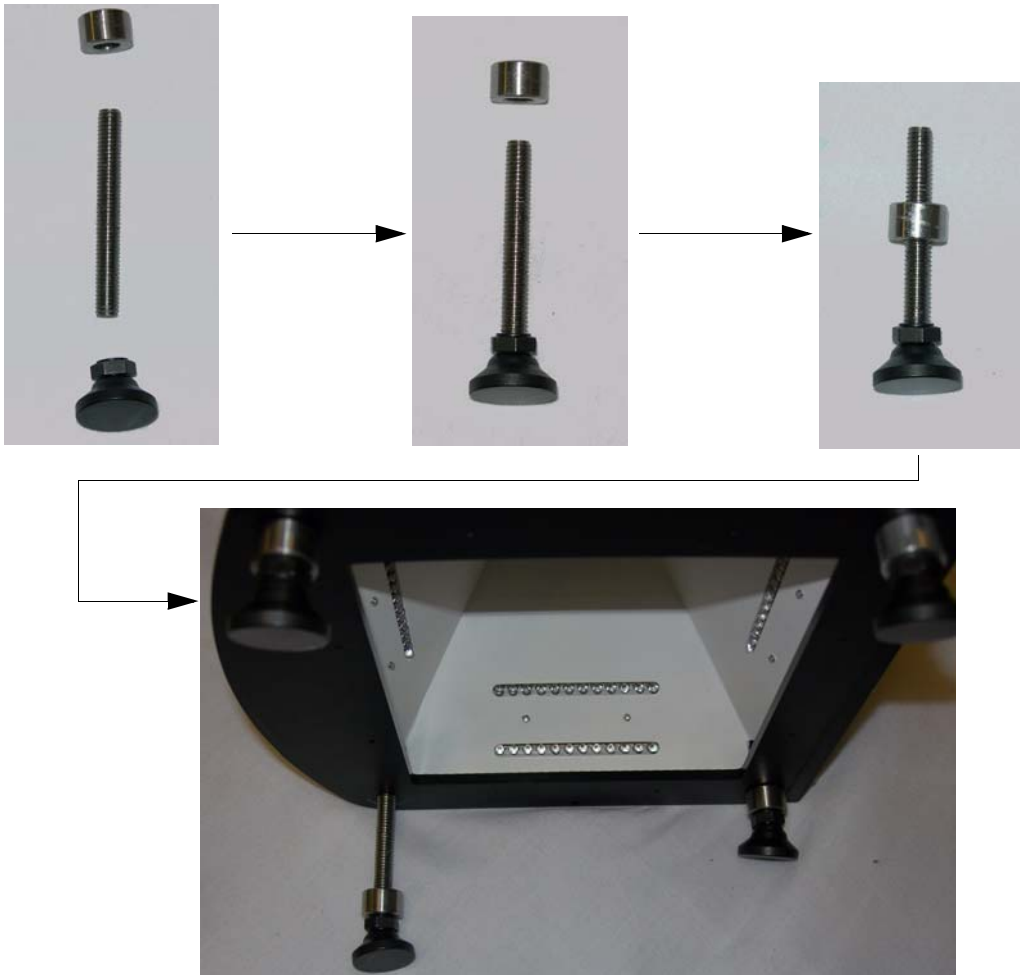

Powering Up the UID-LDP & UID-DPM

1. Connect the power supply to the UID-LDP or UID-DPM, then plug the power supply into a 120V to 230V outlet.
2. Connect the UID-LDP or UID-DPM to your Ethernet network. See “Networking to the UID-LDP & UID-DPM” on page 1-10 for details.

Note: There may be a delay of up to 25 seconds while the verifier sets up to use the default DHCP settings.

Loading the Software

Note: To install the UIDChecker™ software, you must be logged on with Administrator privileges. Contact your IT department for help getting Administrator privileges. You do not need to have Administrator privileges to run the UIDChecker™.

Note: You must remove older versions of the software before upgrading. If beta versions of this version software have been installed, the results directory must be moved, renamed, or deleted, as earlier database records are incompatible with the released version.

Use the following procedure to install the UIDChecker™ software:

1. Insert the Tools Drive in a USB port on your computer. In a few moments, the UIDChecker™ software will automatically start the installation program. If this fails, select the UID_Checker folder in Windows Explorer and run the Setup.exe program.
2. The installation program installs the UIDChecker™ application and the HawkEye 1500 Smart Camera firmware. (You will need to install the firmware to the HawkEye 1500 camera if you are upgrading your UID Compliance verifier). When the Install program is finished, you may have to reboot your PC. Just follow the on-screen instructions.

By default, the installation of the UIDChecker™ application installs all the necessary components in the C:\Program Files\UIDChecker folder. The folder will be created if it doesn't already exist. You can change the location of the file at installation. All subsequent files, data and images, are located under the main UIDChecker folder on the customer's hard drive.

Networking to the UID-LDP & UID-DPM

The UID-LDP and UID-DPM communicate to the PC using an Ethernet network. There are several ways to connect the UID-LDP/UID-DPM and the PC.

Note: This is often the trickiest part of the installation, especially if you are not familiar with Ethernet and connecting equipment to your network. If this is the case, please contact your IT department for help or contact Microscan.

1. The easiest way to connect your PC and the UID-LDP or UID-DPM is to connect them to an existing local area network (LAN) using the Ethernet cable that is already attached to the verifier. To do this, plug your PC into your LAN, and plug your verifier into your LAN (you will need two Ethernet ports).

FIGURE 1-6. PC & UID-LDP/UID-DPM on Your Ethernet Network

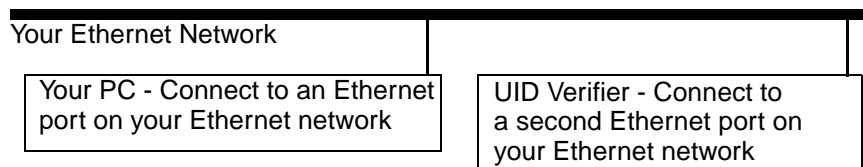

- The second way to connect your PC and the UID-LDP/UID-DPM is to connect them to each other using an Ethernet hub, switch or router (not supplied). You may need your IT department to help you select hardware and set this up.

FIGURE 1-7. Connection Using a Hub, Router or Switch

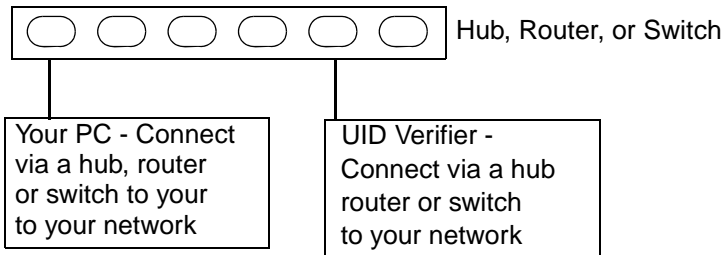

- The final way to connect the PC and the reader is to connect them directly to each other on their own private LAN. Do this by adding the supplied cross-link adapter to the reader's Ethernet cable and plugging it directly into the PC's network card.

FIGURE 1-8. Direct Connect PC & UID-LDP/UID-DPM using Cross-Link Adapter



Cross-Link Adapter (HEENET-XLA)

DHCP and Static IP Addresses Explained

Note: If this is confusing or if you do not understand the terminology, contact your IT department for help.

At the Microscan factory, the UID-LDP and UID-DPM are set to use Dynamic Host Communication Protocol (DHCP). In most cases, this means you simply have to plug the UID-LDP/UID-DPM into your network and plug your PC into your network, and the UIDChecker™ software will just find the verifier and work. This works because your network is set up to automatically assign IP addresses to the computers on the network.

If there is no automatic assignment of IP addresses (no DHCP), then the PC's IP address must be set to communicate with the address of the verifier. To do this, you must have Administrator privileges on the PC, and must do the following:

1. Right click on Network Places and select Properties.
2. Right click on your Network Card and select Properties.
3. Scroll down in the Connection Components list.
4. Select the Internet Protocol item - and select Properties.
5. Select "Use the following IP address" and enter address 169.254.100.100 and mask 255.255.0.0, as shown in Figure 1-9.

FIGURE 1-9. Entering IP Address and Subnet Mask

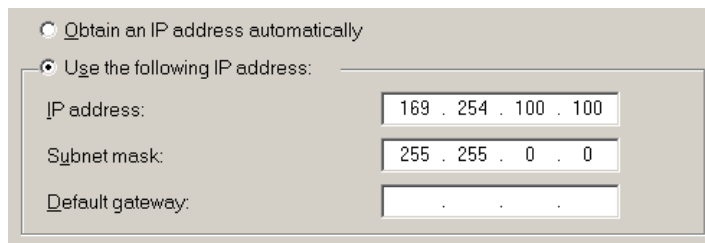

Obtain an IP address automatically

Use the following IP address:

IP address: 169 . 254 . 100 . 100

Subnet mask: 255 . 255 . 0 . 0

Default gateway: . . .

6. Click OK.

Upgrading the UIDChecker™ Software from V2.1

To upgrade an existing UID-CK reader running UIDChecker™ V2.1 or earlier to use the new verification type AIM DPM-1-2006 supported in V2.3, you will need to upgrade the hardware first before upgrading the software.

To upgrade an existing UID-DPM001 running UIDChecker™ V2.1 or earlier to use the new verification type AIM DPM-1-2006 supported in V2.3, we recommend that you upgrade the hardware first before upgrading the software. If you want to use your existing hardware, you can upgrade only the software (see Appendix D, “Upgrading UID-DPM001 w/UIDChecker Software V2.3,” for more information).

If your UIDChecker™ version is older than V2.1, first follow Appendix A, “Upgrading to UIDChecker™ V2.1,” to upgrade your system to running UIDChecker™ V2.1. Then, install the UIDChecker™ V2.3 software as follows:

Put the Microscan Tools Drive in a USB port on your computer and run Setup. The automated program will prompt you to:

1. Uninstall the older version of UIDChecker™ software. Just follow the prompts and click OK.

Note: It will not delete your results!

2. Uninstall the older version of HawkEye’s ReadRunner; this is no longer needed in UIDChecker V2.3. Again, just follow the prompts and click OK.
3. Install the UIDChecker™ software. Just follow the prompts and click OK.

Before using the UIDChecker™ software, you need to upgrade the firmware on the UID reader unit:

1. From the Start Menu, select Programs > UIDChecker > Utilities > Hawkeye Flasher.

The HawkEye Flasher dialog box is displayed, as shown in Figure 1–10.

FIGURE 1–10. Upgrade the HawkEye™ Flasher Dialog Box

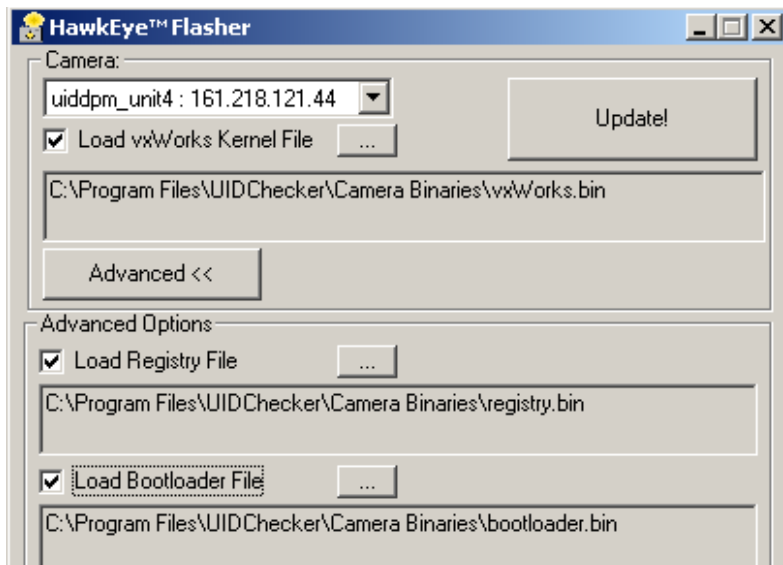

2. In the Camera drop down list, select your UID Verifier and make sure you enable (check) all the check boxes for:
 - Load VxWorks Kernel
 - Load Registry File
 - Load Bootloader.
3. Click Update!

When “Done” appears at the bottom of the terminal display, the process is complete and you can now start the UIDChecker™ software.

Lighting for the UID-LDP & UID-DPM

Both the UID-LDP and UID-DPM support AIM DPM-1-2006 fully compliant lighting options. The UID-LDP uses the diffuse perpendicular lighting (90) for label and data plate applications. The UID-DPM uses the multifunction light that supports all light configurations required by MIL-STD-130M/Change 1 and MIL-STD-130N, as shown in Figure 1–11. In both UID-LDP and UID-DPM, the verification can be triggered from a hardware trigger button and the Read UID Mark software button on the UIDChecker™ GUI.

FIGURE 1–11. Multifunction Light

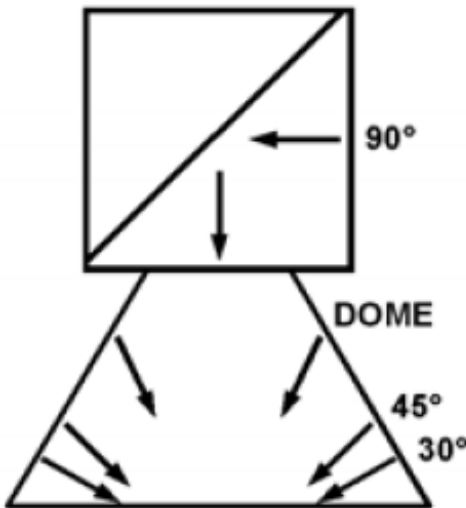

For all verification types except AIM-DPM-1-2006, only diffuse perpendicular lighting (90) is supported in UID-DPM.

Light Configurations

The multifunction light in UID-DPM supports all the light configurations specified in the AIM DPM-1-2006:

- Diffuse perpendicular (on-axis/bright field) (90) — A flat diffusing material is oriented such that the plane of the material is parallel to the plane of the symbol area. The symbol is uniformly illuminated with diffuse light incident at $90 \pm 15^\circ$ relative to the optical axis to the plane of the symbol.

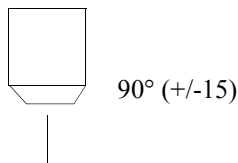

- Diffuse off-axis (D) — A diffusely reflecting dome is illuminated from below so that the reflected light falls non-directionally on the part and does not cast defined shadows. This is commonly used for reading curved parts.
- Low angle, four direction (30Q) — Light is aimed at the part at an angle of $30 \pm 3^\circ$ from the plane of the surface of the symbol from four sides such that the lines describing the center of the beams from opposing pairs of lights are co-planar and the planes at right angles to each other. One lighting plane is aligned to be parallel to the line formed by a horizontal edge of the image sensor to within $\pm 5^\circ$. The lighting illuminates the entire symbol area with uniform energy.

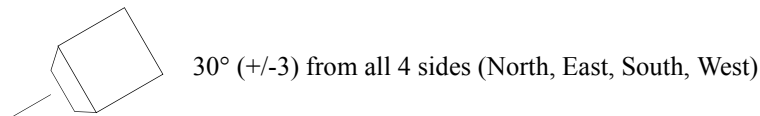

- Low angle, two direction (30T) — Light is aimed at the part at an angle of $30 \pm 3^\circ$ from two sides. The light may be incident from either of the two possible orientations with respect to the symbol. The lighting plane is aligned to be parallel to the line formed by one edge of the image sensor to within $\pm 5^\circ$. The lighting illuminates the entire symbol area with uniform energy.

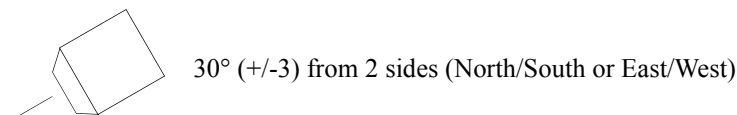

- Low angle, one direction (30S) — Light is aimed at the part at an angle of $30 \pm 3^\circ$ from one side. The light may be incident from any of the four possible orientations. The lighting plane is aligned to be parallel to the line formed by one edge of the image sensor to within $\pm 5^\circ$. The lighting illuminates the entire symbol area with uniform energy.

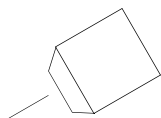

30° (+/-3) from 1 side (North, East, South, West)

- Medium angle, four direction (45Q) — Light is aimed at the part at an angle of $45 \pm 3^\circ$ from the plane of the surface of the symbol from four sides such that the lines describing the center of the beams from opposing pairs of lights are co-planar and the planes at right angles to each other. One lighting plane is aligned to be parallel to the line formed by a horizontal edge of the image sensor to within $\pm 5^\circ$. The lighting illuminates the entire symbol area with uniform energy.

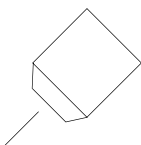

45° (+/-3) from all 4 sides (North, East, South, West)

Positioning Data Matrix Mark for Verification

Always ensure the bottom plane of the light in UID-LDP and UID-DPM is parallel to the plane of the Data Matrix symbol area.

Use Live Video to ensure the Data Matrix mark is centered in the FOV with the correct orientation.

Light Control

The light in UID-LDP and UID-DPM will be switched on when the UIDChecker™ program starts up and switched off when the program exits. The state of the multifunction light is saved so that the program, when restarted, will use the same light configuration as in the previous operation. The default light configuration is 90 for the UID-DPM.

Triggers

In UID-LDP and UID-DPM, the verification can be triggered from:

- A hardware trigger button
- The Read UID Mark software button on the UIDChecker™ GUI

Note: The hardware trigger is disabled for the verification type MIL-STD-130L Change 1 (ISO 15415) in order to support Read and Rotate. See Appendix B, “Read And Rotate,” for details.

Quickly Using UID Compliance Verifier

After loading the UIDChecker™ application software on your PC and powering up the UID Compliance Verifier, you are now ready to begin using your UID Compliance Verifier to read UID marks.

Using Your UIDChecker™ Software

To launch the UIDChecker™ application, select and click on the UIDChecker™ desktop icon, as shown in Figure 2–1.

FIGURE 2–1. UIDChecker™ Icon



First Time Startup

The first time you launch the application, the UIDChecker software will prompt you for a Reader on the network to connect to. After that, it will attempt to re-connect to the last reader each time it is launched, as shown in Figure 2–2.

FIGURE 2-2. Find a Reader Menu Item

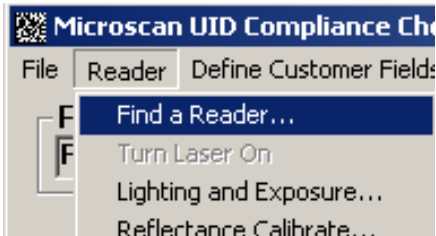

This option displays a list of readers on your network. If you have been successful in setting up the network connection to the camera, you will find the reader on the list. The name should begin with “UID”. Select your reader from the drop down list.

Note: On some networks, there may be a delay of several minutes when you power on and plug the Ethernet cable into your network. If no readers show up in the drop down list (see Figure 2-3), then close the UIDChecker™ software, wait five minutes, and launch the program again.

FIGURE 2-3. Drop Down List of Readers

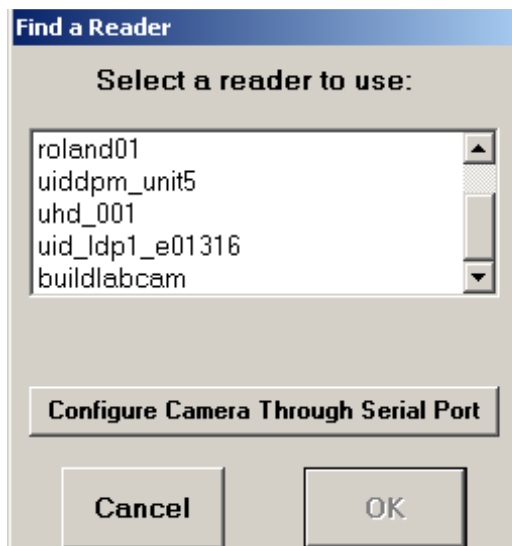

Once this has been done, the system will remember the reader and will connect to it automatically. The command buttons will become active, as shown in Figure 2–4:

FIGURE 2–4. Command Buttons Active



Subsequent Startups

As stated above, upon first-time startup, the UIDChecker will prompt for a reader on the network to connect to. Upon subsequent restarts of UIDChecker™, the UIDChecker™ will remember its reader and automatically select it, and the UID Verifier will be ready to run.

Testing the UID Compliance Verifier

After completing all the hardware setup and software loading, you will want to perform a quick check to ensure that your UID-LDP or UID-DPM verifier is working properly. You will need the Microscan Calibration Test Card (Microscan part number 98-UA10-0CC0) and the UID Compliance Card (Microscan part number A4-20814-1A) to test your UID-LDP or UID-DPM.

Perform Reflectance Calibration

Note: Please refer to Reflectance Calibration in Chapter 3 for more detail.

Once you have positioned your UID-LDP or UID-DPM into your work space, you need to calibrate the system using this Calibration Target.

1. Ensure UIDChecker™ has connected to your verifier. If you have never calibrated the verifier from the UIDChecker™, you will see that Last Calibrated: UNKNOWN displayed in Figure 2–5:

FIGURE 2-5. Last Calibrated: UNKNOWN

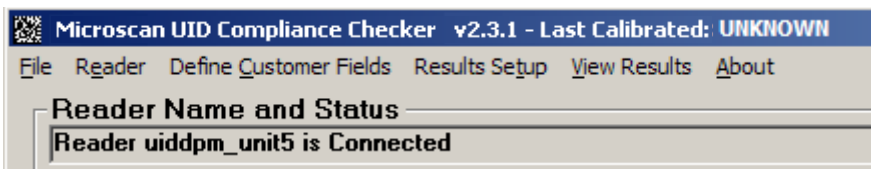

- The Reflectance Calibration box should be displayed automatically. If it is not, click Reader > Reflectance Calibrate to bring up the Calibration dialog box, as shown in Figure 2-6.

FIGURE 2-6. Reflectance Calibration Dialog Box

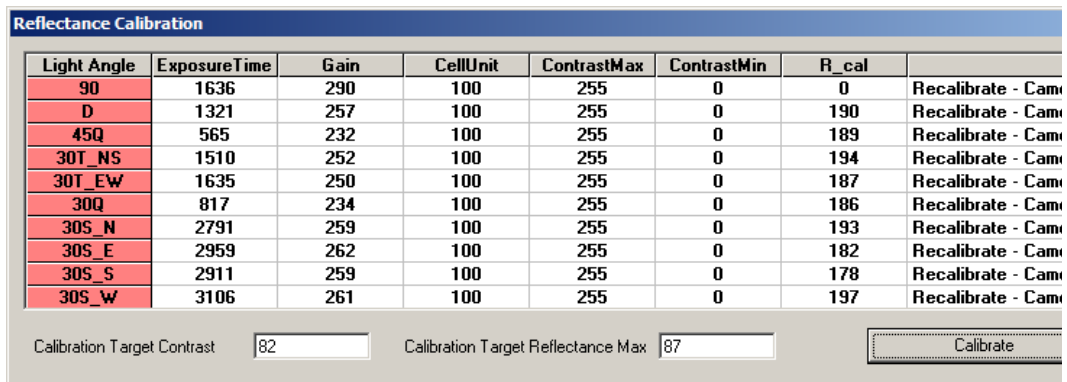

- In the Calibration Target Contrast text box (see Figure 2-6), enter the Contrast value shown on the card associated with the Data Matrix (80% contrast) you are using as the target. For example, if the contrast marked for the Data Matrix on the Calibration Test Card is 82.6%, you would enter 82.6 or 83.
- In the Calibration Target Reflectance Max text box (see Figure 2-6), enter the Rmax value shown on the card associated with the Data Matrix (80% contrast) you are using as the target. For example, if the R_max marked for the Data Matrix on the Calibration Test Card is 87.4%, you would enter 87.4 or 87.

Live Video mode is enabled.

- Position the Data Matrix (around 80% contrast) under the UID-LDP or UID-DPM. Center the Data Matrix in the camera's FOV, as shown in Figure 2-7.

FIGURE 2-7. Data Matrix Centered in FOV

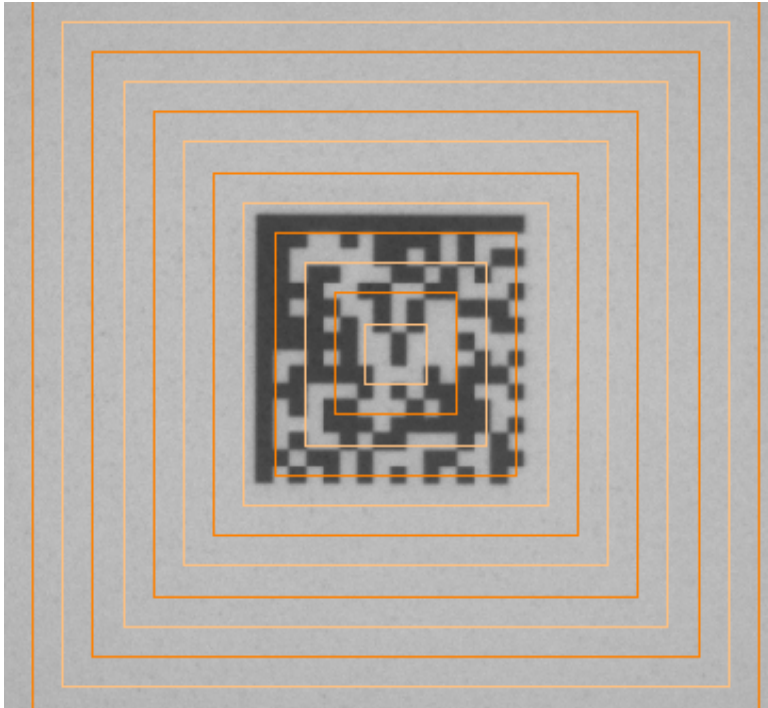

6. Click **Calibrate** on the Reflectance Calibration dialog box (Figure 2-6). The UIDChecker™ will calibrate the verifier in less than 10 seconds, or post error messages if it can't. All calibration data are saved to the verifier. Click **Close** to exit the dialog box. The top border of the UIDChecker™ application will display the last calibration date. Also, the calibration date will be posted in the Results display.

Test the Correct Calibration

1. Launch the UIDChecker™ application if it is not already running.
2. Select **Reader > Verification Type > MIL-STD-130N (ISO 15415)**. Note that the verification type MIL-STD-130N (ISO 15415) is the easiest one to test the correct calibration.
3. Select **Results Setup > Show Verification Details in On-Screen Results View**.

4. Click **Live Video**. Position the higher contrast (about 80%) Data Matrix on the Microscan Calibration Test Card under the UID Verifier. Center the Data Matrix on the screen with correct orientation, as shown in Figure 2–8. (For UID-LDP, the laser lines are at the middle of the FOV). Note that the Data Matrix can be rotated but one of the “L” borders must be parallel to one of the lines in the video overlay.

FIGURE 2-8. Data Matrix in Center with Correct Orientation

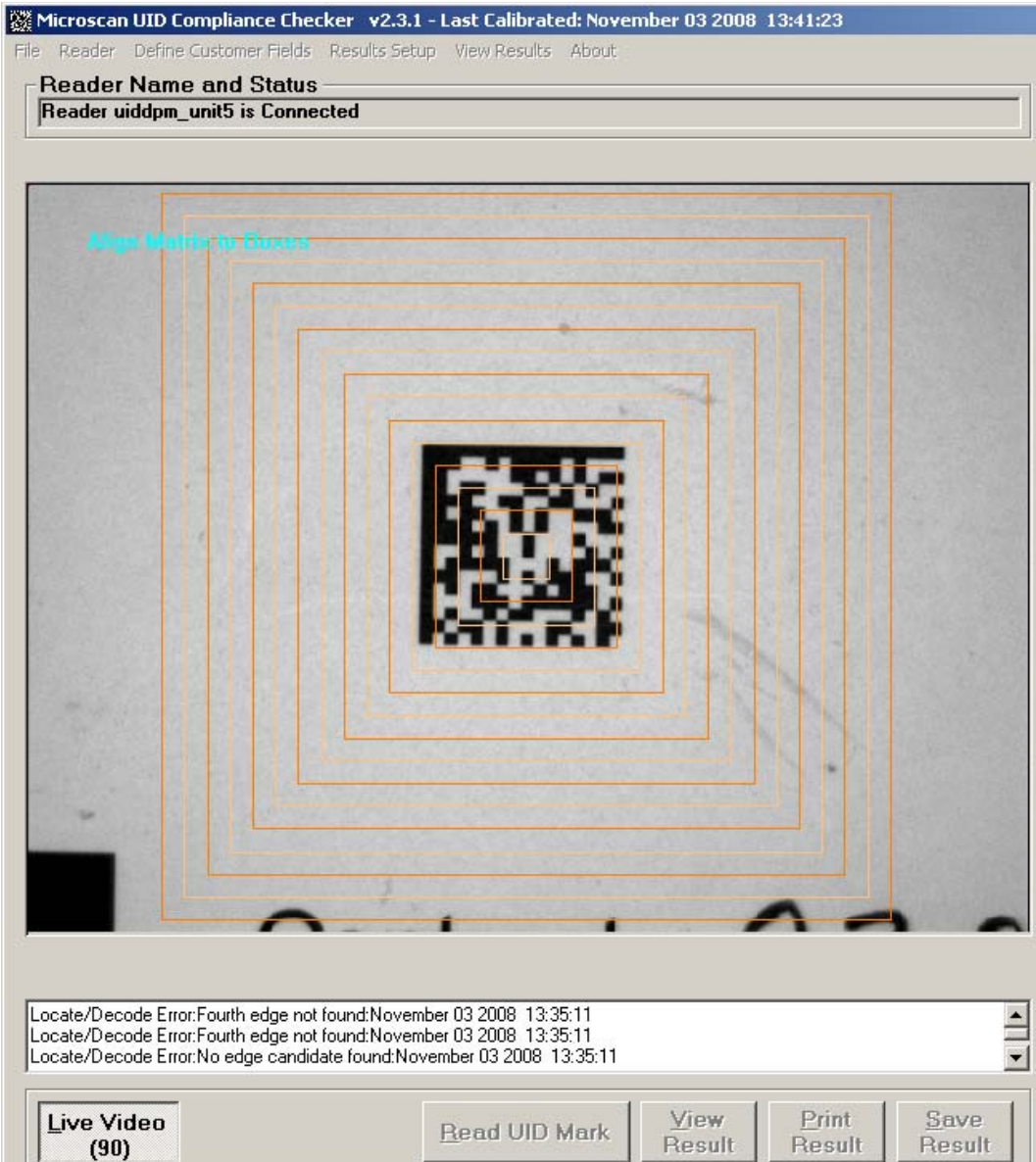

2
Quickly Using UID Compliance Verifier

5. When you are finished positioning the target, click Live Video again (to exit Live Video).

- Click Read UID Mark to verify the correct report for contrast and cell size. The contrast should match the value (with tolerance of +/- 2%) shown on the Calibration Test Card and the cell size should be reported as 0.015 +/- 0.0001 inches, as shown in Figure 2–9.

FIGURE 2–9. Test Calibration Using Contrast & Cell Size

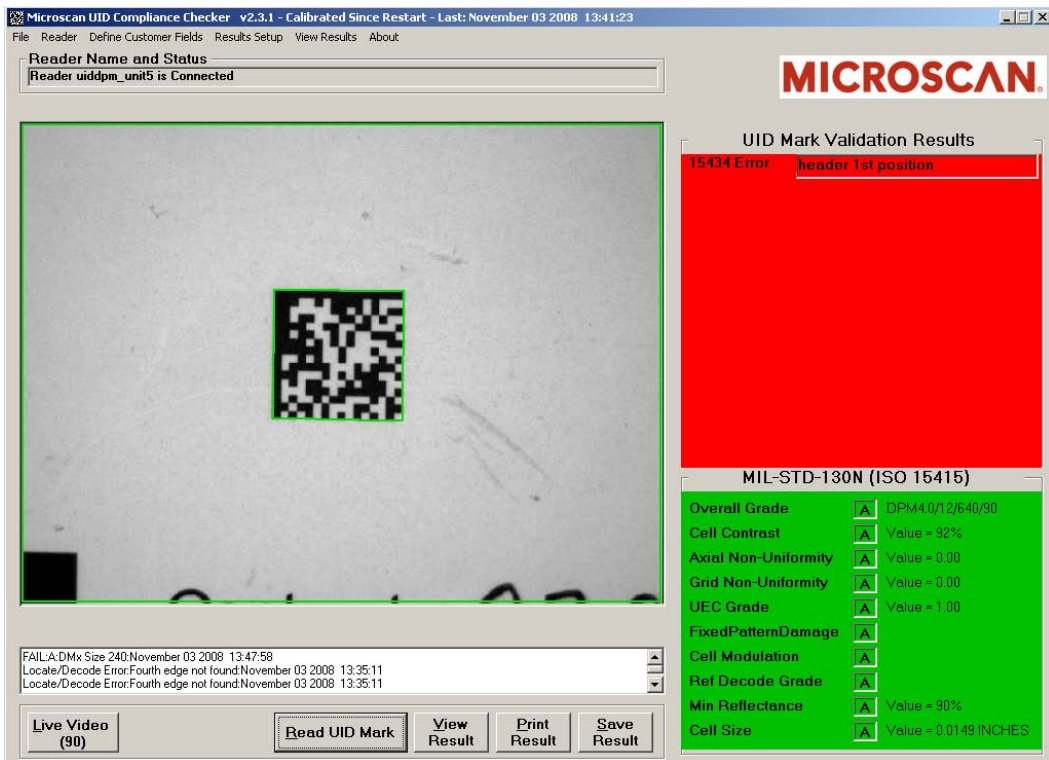

Test the Correct Operation

Note: Cell Contrast is defined differently than the normal contrast value used in ISO/IEC 15415 and will not match the value shown on the calibration card.

- Select Reader > Verification Type > MIL-STD-130N (AIM DPM-1-2006). Ensure that Report is set to First Passing Overall Grade. Click OK.

2. Click **Live Video** and position the UID Compliance Card's "Correct Format" Data Matrix in the FOV of the reader, as shown in Figure 2–10.

FIGURE 2–10. Live Video

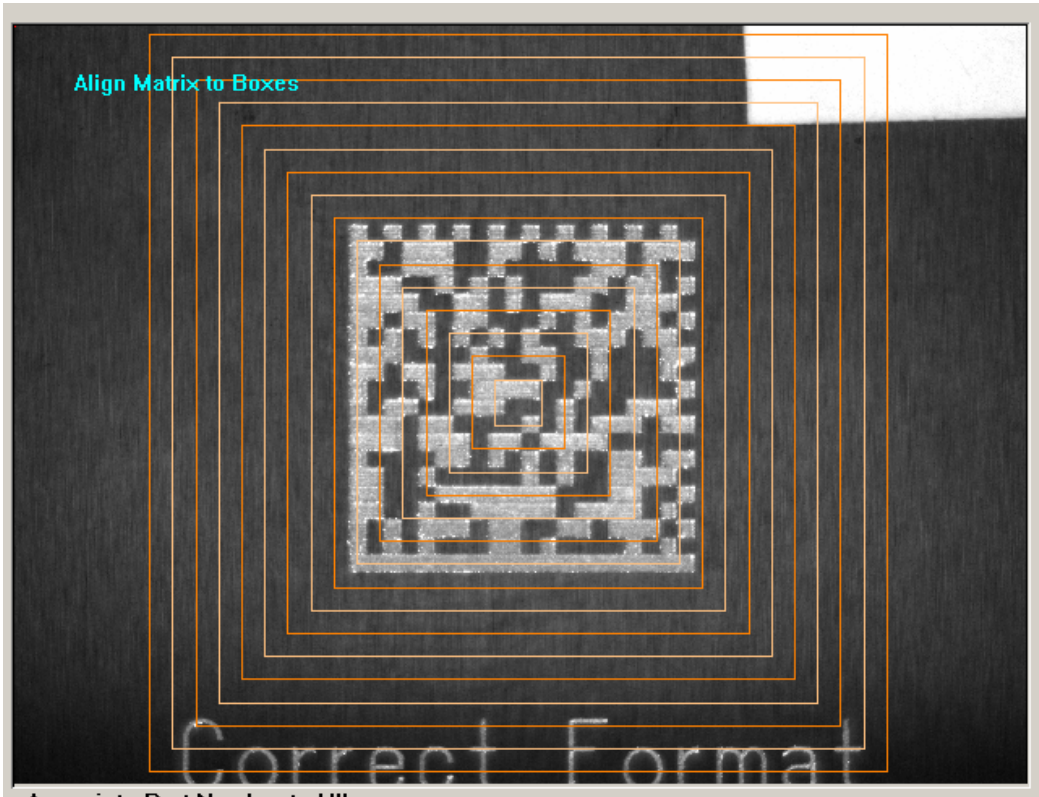

3. When you are finished positioning the UID Compliance Card's "Correct Format" Data Matrix, click **Live Video** again (to exit Live Video).
4. Click **Read UID Mark** and verify that you get a Good read result similar to the one shown in Figure 2–11. The UID Mark is valid and its contents correctly formatted.

FIGURE 2–11. Good Read Result

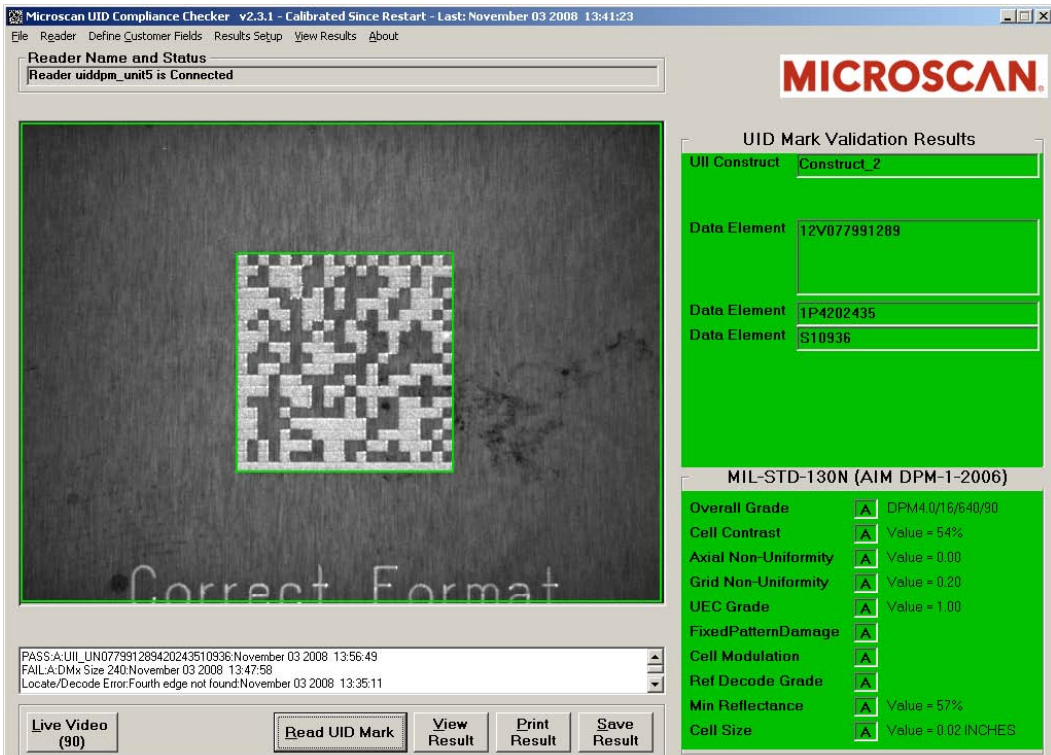

- Next, repeat the same process using “Incorrect Format” and verify you get a Fail read result similar to the one shown in Figure 2–12. The UID Mark is read but the data contents are wrong -- they have an incorrect format -- thus, the read is trapped as a “Fail”.

FIGURE 2–12. Incorrect Format Read Yields a Failure Result

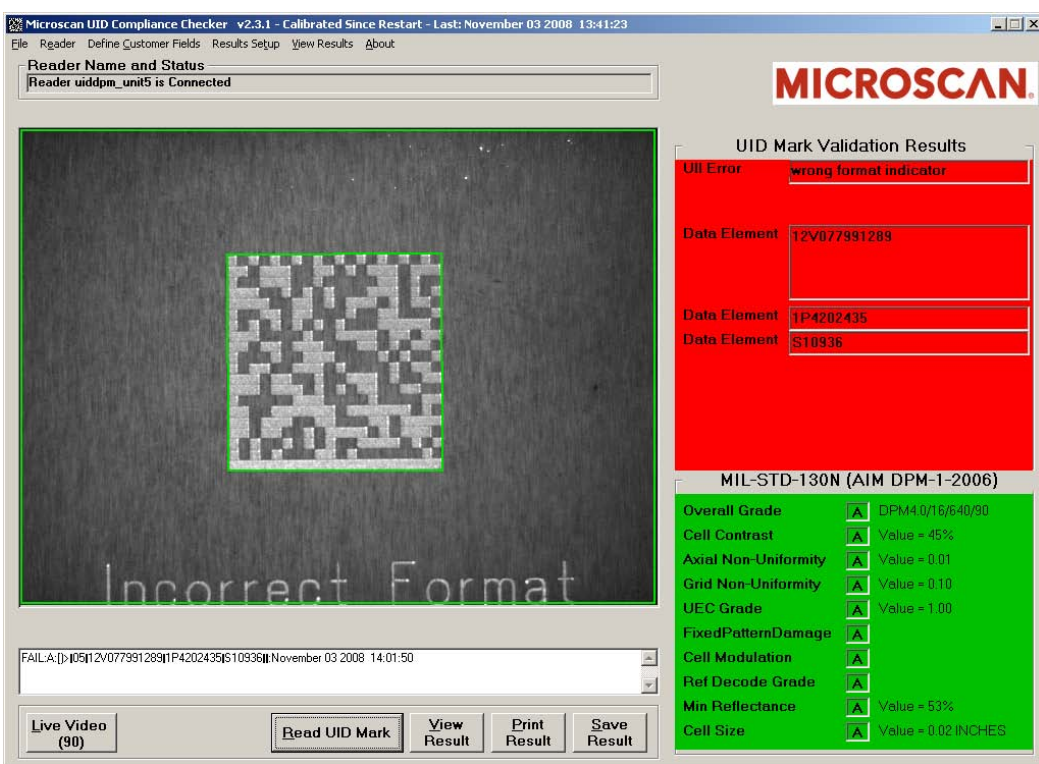

2
Quickly Using UID Compliance Verifier

UIDChecker™ Application Details

In this chapter, we give an overview of UIDChecker™ and then explain each button, menu item and dialog box.

File Naming Scheme

The UII string is now part of the saved result's file name:

- In the case of a good read and verification, when you save the results to a file, the file name consists of the UII String followed by “_Result_” followed by an auto incrementing result counter. For example:

```
UN077991289420243510936_Result_00000001.html
```

- In the case of a bad read, you will get a file name similar to the following:

```
Not a valid UID Data Matrix_Result_00000050.html
```

- In the case of Summary reports, for Read And Rotate in the MIL-STD-130L Change 1 and Overall Grade for All Lights report mode in the MIL-STD-130M/Change 1 (AIM DPM-1-2006 for DPM) or MIL-STD-130N (AIM DPM-1-2006), the file name is:

```
Summary_00000006.html
```

Secured UID Verifier

The secured mode in the UID verifier can be enabled by ordering and enabling a license key from Microscan. Once the verifier is in the secured mode, all image display features will be disabled. The HawkEye smart camera will not allow a non-secured firmware version (any version prior to v2.2.0) to be installed that does not support the secured operation.

UIDChecker™ User Interface Overview

UIDChecker™ will start up and connect automatically to the last reader used and be ready to read a UID Mark.

While in the UIDChecker™ application, you can “Alt-Tab” to other programs running on the PC. You can also minimize the UIDChecker™ application.

There are two areas of UID Mark feedback on the display:

- An area to display the image (Figure 3–1)
- An area to display the verification and validation results (Figure 3–1)

FIGURE 3–1. UIDChecker™ Main Window

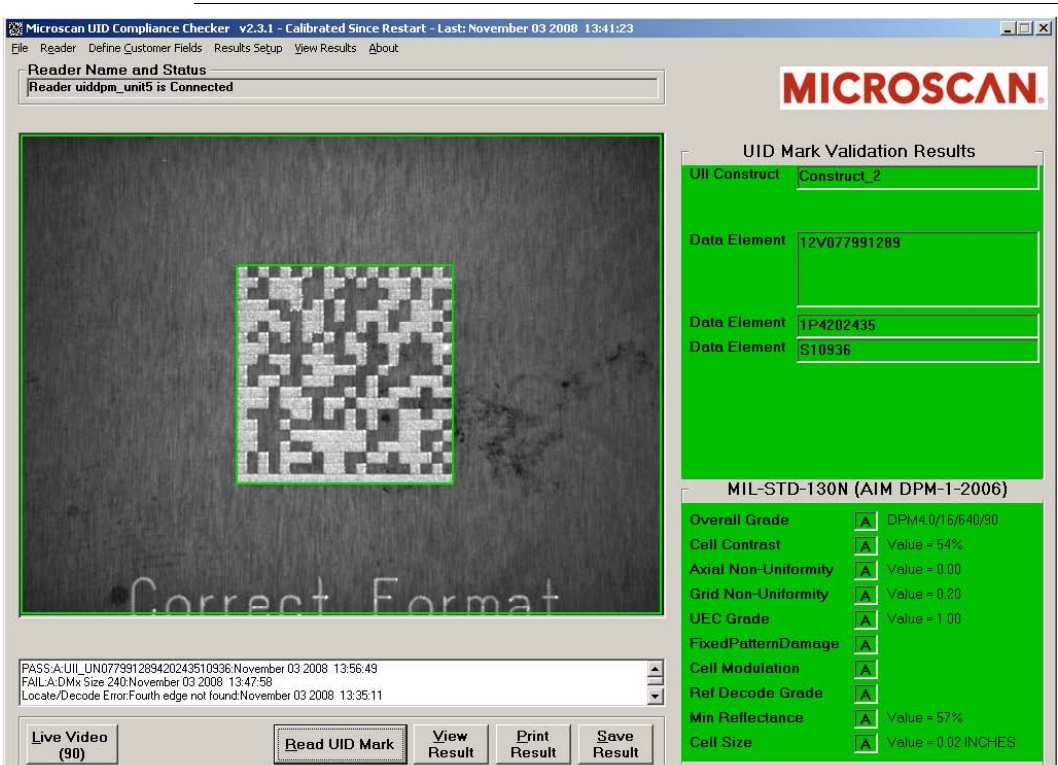

UIDChecker™
 Application Details

UID Read & Graphical Display Details

Image

A picture box is on the left-hand side of the main display to show the Live Video display and the last read UID mark image.

Validation Text Result

A color keyed graphical text area is on the upper right-hand side of the main display. After reading a UID Mark, the background of the text display turns red or green, depending on the state of the Uii string validation. The validation results are listed clearly in this text display.

Verification Text Result

A color keyed graphical text area is on the lower right-hand side of the main display. After reading a UID Mark, the background of the text display turns either green or red, depending on the state of the UID mark quality verification. The verification results are listed clearly in this text display.

UID Mark Read Result/Status

The UID Mark Read Result/Status is:

- Pass when both the Validation and Verification are successful, indicated by green background of the text display
- Fail when at least one of the Validation and Verification is unsuccessful, indicated by red background of the text display

Light Indicators

UID-LDP has light indicators mounted on the top plate. UID-DPM has light indicators on both the top and front. The light indicators are illuminated to match the UID Mark Read Result/Status: red if Fail, green if Pass.

Text Box for UII Only Validation

A text box of the last UID reads appears below the image display. The data to be displayed is in the following format:

- **If the mark:**
 - **Is UII compliant**, the line added to the text box will look similar to the following:

```
PASS:B:UUI_LBF987654321ABC420243510936:March 14 2008 14:36:54
```

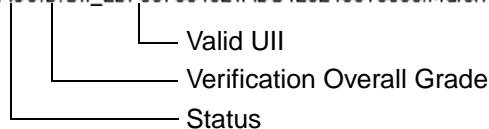

- **Has the correct UII format, but the Verification failed**, the line added to the text box will look similar to the following:

```
FAIL:F:UUI_LBF987654321ABC420243510936:March 14 2008 14:43:28
```

- **Has an invalid UII format**, the line added to the text box will look similar to the following:

```
FAIL:A:DMx Size 240:June 18 2007 06:25:04
```

- **If an error occurred:**

- **Locating or decoding the mark**, two lines are added to the text box. The second line begins with “Locate/Decode Error:” followed by the error code (see Table 3–2, “Data Matrix Locate/Decode Error Codes,” on page 3-39):

```
FAIL:::June 18 2007 06:35:14
Locate/Decode Error:Unable to decode:June 18 2007 06:35:14
```

- **Verifying the mark**, two lines are added to the text box. The second line begins with “Verification Error:” followed by the error code (see Table 3–3, “Data Matrix Verification Error Codes,” on page 3-40):

```
FAIL::UII_LBF987654321ABC420243510936:March 14 2008 14:38:33
Verification Error:ISO Verification failed RDA STEP F 3:March 14 2008 14:38:33
```

Text Box for CPN/LBN Only Validation

A text box of the last UII reads appears below the image display. By default, a Current Part Number (CPN) or Lot/Batch Number (LBN) mark will be rejected as an invalid UII format. To validate a CPN/LBN, select **Results Setup > Enable CPN/LBN Support**. The data to be displayed is in the following format:

- If the mark:
 - **Is validated as PNR, 30P, 240, or 30T**, the line added to the text box will look similar to the following:

Note: The part number is displayed in the CPN/LBN_ text box below the image display.

```
PASS:B:CPN/LBN_1A2B3C4D-5E/6F1A2B3C4D-5E/6F7G8I:March 14 2008 14:48:17
```

- **Has the correct CPN/LBN format, but the Verification failed**, the line added to the text box will look similar to the following:

```
FAIL:F:CPN/LBN_1A2B3C4D-5E/6F1A2B3C4D-5E/6F7G8I:March 14 2008 14:57:00
```



- **Has an invalid CPN/LBN format**, the line is the same as “Has an invalid UII format” in UID Validation:

```
FAIL:B:[]>|05|2401A2B3C4-5E6F7G81A2B3C4D5E6F7G8||:March 14 2008 14:59:41
```

- **If an error occurred**, the result is the same as those in UID Validation.

Text Box for Validating UII & CPN/LBN in a Single Symbol

To validate both UII and CPN/LBN in a single Data Matrix symbol, select **Results Setup > Enable CPN/LBN Support**. In addition to the formats described in “Text Box for UII Only Validation” and “Text Box for CPN/LBN Only Validation”, you may also see the following cases:

- If the mark has:
 - **Valid UII and CPN/LBN:**

```
PASS:B:UII_D1U2R7MH80312 CPN/LBN_1A2B3C4D5E6F7G81A2B3C4D5E6F7G8:March 14 2008 15:53:10
```

- **Valid UII and invalid CPN/LBN:**

```
FAIL:B:UII_D1U2R7MH80312 (CPN/LBN ERROR):March 14 2008 16:00:51
```

- **Invalid UII and valid CPN/LBN:**

```
FAIL:B:(UII ERROR) CPN/LBN_6F1A2B3C4D:March 14 2008 16:02:45
```

- **Invalid UII and CPN/LBN:**

```
FAIL:B:[]>|06|18S1U2R7#|80312|30P6F1A2#|C4D||:March 14 2008 16:04:49
```

The text box has scroll bars for scrolling back to previous read results. There is a limit of 20 UII read results that can be displayed in this region. The **Clear Log** button on the “Results Setup Dialog” allows you to clear manually the text box. Upon restart of this UIDChecker™ application, the text box is cleared automatically.

UIDChecker™ Buttons Overview

Tool tips are available for each of the main buttons shown in Figure 3–2:

FIGURE 3–2. UIDChecker™ Main Buttons

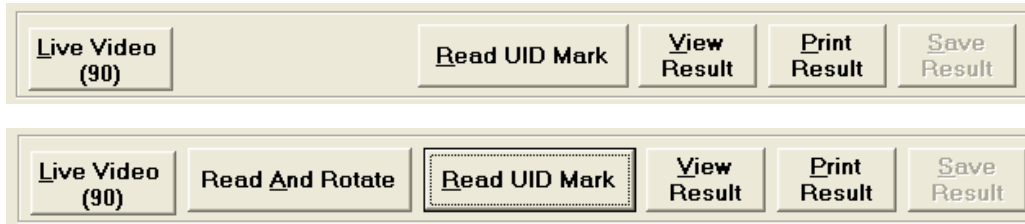

- “Live Video” starting on page 3-7
- “Read And Rotate” starting on page 3-8
- “Read UID Mark” starting on page 3-8
- “View Result” starting on page 3-9
- “Print Result” starting on page 3-9
- “Save Result” starting on page 3-9

Live Video

Use the Live Video button to position a mark in the FOV of the reader. Note that the Data Matrix must be completely within the screen for a successful read. For UID-LDP, the laser lines are at the middle of the FOV.

Live Video is enabled once connected to a UID reader. Clicking Live Video displays the live video from a reader on the user interface. Clicking Live Video a second time stops the Live Video update. If Live Video is enabled, all other user interface buttons and drop down menus are disabled until the Live Video update is complete. When the Live Video update is complete, the result text display is cleared.

When the verification type is set to MIL-STD-130M/Change 1 (AIM DPM-1-2006 for DPM) or MIL-STD-130N (AIM DPM-1-2006), Live Video can adjust automatically the exposure to obtain the proper contrast of the mark. In UID-DPM, Live Video can be used to display images for each supported light configuration.

For a secured UID verifier, LiveVideo displays the outline of the Data Matrix mark without the image itself. To improve the responsiveness of the live video, it is recommended that the Data Matrix be centered using fixtures.

Read And Rotate

The Read And Rotate button is visible when you select the MIL-STD-130L Change 1 (ISO 15415) Verification Type. Refer to Appendix B, “Read And Rotate,” for details.

Read UID Mark

After you click Read UID Mark, reading and decoding may take up to one second. Once the mark is read, the PC screen and the light will be updated to reflect the UID compliance and the mark quality verification status.

Note: If the verification type is set to MIL-STD-130M Change 1 (AIM DPM-1-2006 for DPM) or MIL-STD-130N (AIM DPM-1-2006) with a report mode of Overall Grade For All Lights, a sequence of images are taken with different lights and will take longer than one second.

Note: F8 is the hotkey to read a mark; it simulates a mouse click on the Read button. Also, the Read button retains the focus of the application, so clicking the Enter button on the Keyboard will also begin a “Read”. The UIDChecker application must be in focus for these hotkeys to work.

Analyzing the Results of UID Compliance Check

If the Data Matrix mark is a valid UID mark and is verified to be of good quality, then both the Validation and Verification panels at the right of the screen will become green. The light on top of the unit will also show green.

If either the validation or the verification test failed, the appropriate panel will be red and the light on top of the unit will show red.

If the UID mark is valid, then the validation results panel reports the UID mark components. As long as the Data Matrix can be decoded and verified, the verification panel shows the grading on each of the verification parameters corresponding to the verification type specified.

Results

When a mark is decoded, extra buttons appear on the screen: View Results, Print Results and Save Results. A complete description of the Results can be found on “View Results” starting on page 3-28.

View Result

Select **View Result** to see the full UID Mark report including the image. This will transfer you to the results display. From here, you can manage your UII read results. This is fully explained in “View Results” starting on page 3-28.

Note: The image will contain only the outline of the Data Matrix for a secured UID verifier.

Print Result

Select **Print Result** to send the current UID Read report to the PC’s default printer. Print Result combines the last UID Mark read image, compliancy results, and the customer defined fields onto a one sheet 8½ x 11 inch printout. Then, you can specify your local or network printer.

Note: The button is only enabled when the result text area of the screen contains data.

These results contain a Microscan logo and contact information. This logo may be replaced with a customer-selected bitmap of appropriate size. See “Define Customer Fields” on page 3-21.

Save Result

Select **Save Result** to save the current UID Read results and the image to a file on the PC’s hard drive. This button is enabled if automatic logging of read results is OFF. Clicking **Save Result** appends the read results, including the name of the image file, to the data file.

Note: The button is only enabled when the result text area of the screen contains data.

Main Menu Items

The main menu items are:

- “File” starting on page 3-10
- “Reader” starting on page 3-10
- “Define Customer Fields” starting on page 3-21
- “Results Setup” starting on page 3-22
- “View Results” starting on page 3-28
- “About” starting on page 3-36

File

Exit

This menu item exits the UIDChecker™ application. This button allows a graceful exit from the UIDChecker™ program. The laser and LEDs are shut off when the UIDChecker™ program is exited.

Reader

Find a Reader

This menu item launches an applet to show all the readers on the customer’s network. The customer needs to simply browse the display of readers and, with his mouse, select his reader from the list.

FIGURE 3-3. Drop Down List of Readers

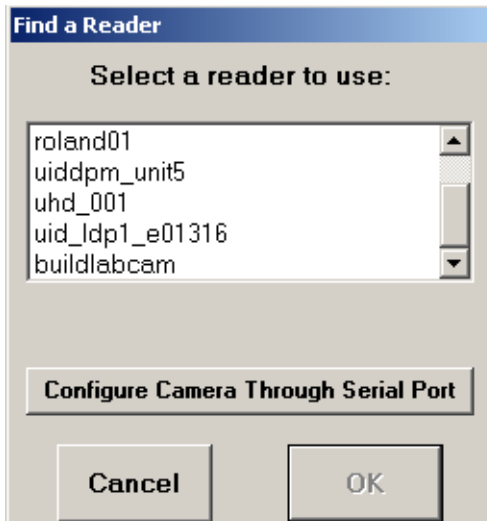

If the reader cannot be found, select the Configure Camera Through Serial Port button to display the dialog box shown in Figure 3-4:

FIGURE 3-4. Communications Configuration

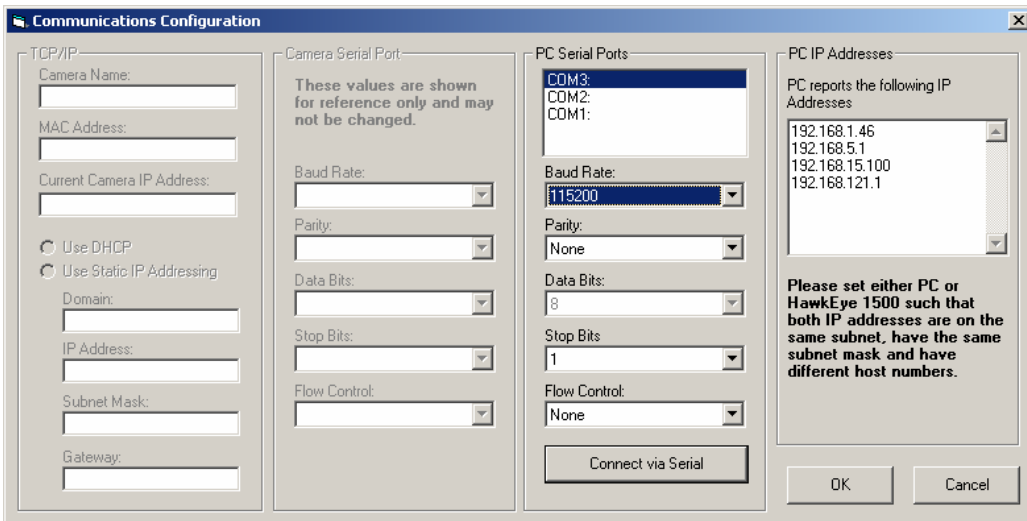

With the serial cable plugged in to the PC's COM port and the UID verifier, select the correct PC Serial Ports then click the Connect via Serial to display the screen displayed in Figure 3–5:

FIGURE 3–5. Communications Configuration — After Successful Connection

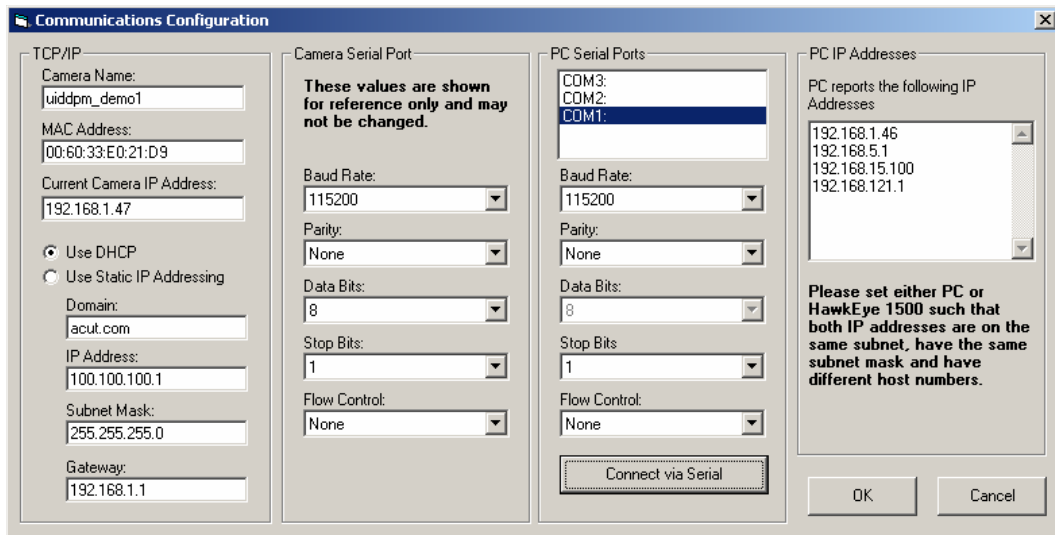

Notes: The camera serial port in the UID verifier is configured at the factory with the setting: Baud Rate 115200, Parity None, Data Bits 8, Stop Bits 1, Flow Control None. The serial port setting for PC Serial Ports are locked to be the same as the camera and cannot be changed.

If your PC has more than one serial port and you select the wrong serial port from PC Serial Port and click the **Connect via Serial** button, the software will take a long time to time out and fail to make the connection. When this happens, it is possible that you will not be able to connect the PC to the camera even though you then select the correct serial port. You need to click the **Cancel** button on each of the two dialogs and then exit UIDChecker. Restart UIDChecker, select the correct PC serial port, and click the **Connect via Serial** button again.

To ensure Ethernet communication, you need to set either PC or the UID verifier such that both IP addresses are on the same subnet, have the same subnet mask and have different host names. In the above example, the UID verifier IP address is 192.168.1.47 and the PC IP address is 192.168.1.46.

Turn Laser Off

When this menu item is clicked, the laser on the UID-LDP verifier can be turned off and the menu option will be re-captioned to be “Turn Laser On”. Clicking Turn Laser On will turn the laser on and re-caption this menu option to “Turn Laser Off”.



Caution

If the targeting lasers are activated, do not stare into the beams. The UID-LDP’s targeting lasers have been rated as Class II lasers by IEC 60825-1.



Warning

DO NOT LOOK DIRECTLY AT THE BEAMS OF THE LASER!

Calibrate

You MUST calibrate your UID-LDP and UID-DPM upon first time startup in your production area and, again, if you move the UID reader or the ambient light changes. The work environment where you will use your UID reader should be a stable environment in terms of lighting. For example, if you work in an office near windows, there might be read considerations when you perform a read at noontime on a sunny day versus a read performed during 3rd shift at 2AM on a moonless night. We suggest you position the UID reader in a fairly steady-state lighting environment where ambient light is consistent and at a low level.

For certain verification types, such as AS9132 Dot Peen, where contrast is not read or reported, calibration is performed to simply relate pixel size to dimensional units. In this case, the camera should be calibrated normally using the supplied calibration target, and then photometry values may be changed to obtain good images with dark or reflective samples.

The UID-LDP and UID-DPM comes with a Calibration Target (Microscan part number 98-UA10-0CC0). Once you have positioned your UID-LDP and UID-DPM into your work space, you need to re-calibrate the system using this Calibration Target.

1. Position the Data Matrix (around 80% contrast) under the UID-LDP or UID-DPM.

2. Click Reader -> Reflectance Calibrate to bring up the Calibration dialog box, as shown in Figure 3–6.

FIGURE 3–6. Calibration Dialog Box

Light Angle	ExposureTime	Gain	CellUnit	ContrastMax	ContrastMin	R_cal	Status
90	1613	296	178	226	0	181	July 31 2007 06:06:33
D	1132	249	178	233	0	187	July 31 2007 06:06:34
45Q	520	248	178	230	0	185	July 31 2007 06:06:34
30T_NS	1529	252	178	228	0	184	July 31 2007 06:06:35
30T_EW	1564	265	178	233	0	187	July 31 2007 06:06:35
30Q	887	230	178	232	0	186	July 31 2007 06:06:36
30S_N	3174	271	178	232	0	183	July 31 2007 06:06:36
30S_E	3174	267	178	231	0	181	July 31 2007 06:06:37
30S_S	2620	265	178	240	0	187	July 31 2007 06:06:37
30S_W	2804	277	178	245	0	193	July 31 2007 06:06:38

Calibration Target Contrast: Calibration Target Reflectance Max:

- Light Angle — Displays light configurations (or light angle) available to the connected UID verifier. For UID-LDP, only 90 is displayed.
- Exposure Time — Displays exposure time for the HawkEye 1500 camera corresponding to each light configuration. These values are normalized at factory and will not change by the Reflectance Calibration.
- Gain — Displays camera gain control value for the HawkEye 1500 camera corresponding to each light configuration. These values are normalized at factory and will not change by the Reflectance Calibration.
- CellUnit — Displays how the verifier relates pixel values to inches for each light. All the values displayed should be the same or vary by no more than +/- 1.
- ContrastMax/ContrastMin — These values are used to calibrated contrast value for all verification type except MIL-STD-130M/Change 1 (AIM DPM-1-2006 for DPM) or MIL-STD-130N (AIM DPM-1-2006). These are calibrated by the reflectance calibration.
- R_cal — These values are calibrated for MIL-STD-130M/Change 1 (AIM DPM-1-2006 for DPM) or MIL-STD-130N (AIM DPM-1-2006) for reporting Minimum Reflectance.
- Status — Displays the date and time when the reflectance calibration takes place. If unsuccessful, error messages are displayed here.

3. In the Cal. Target Contrast text box, enter the value associated with the Data Matrix (80% contrast) you are using as the target. For example, if the contrast marked for the Data Matrix on the Calibration Test Card is 82.6%, you would enter 82.6 or 83.
4. In the Cal. Target Reflectance Max text box, enter the value associated with the Data Matrix (80% contrast) you are using as the target. For example, if the R_max marked for the Data Matrix on the Calibration Test Card is 87.4%, you would enter 87.4 or 87.
5. The Live Video mode is enabled. Center the Data Matrix (about 80% contrast) on the Calibration card in the camera's FOV.

FIGURE 3–7. Data Matrix Centered in FOV

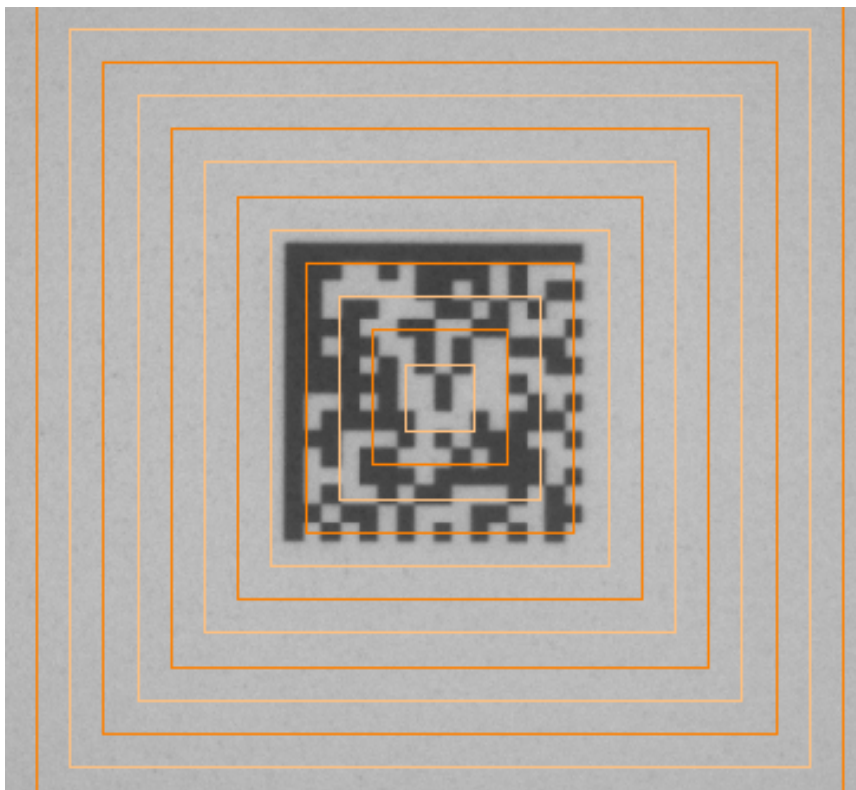

6. Click Calibrate.

The UIDChecker™ will calibrate the reader in less than 10 seconds or post error messages if it can't. All calibration data are saved to the verifier. The top border of the UIDChecker™ application will show the last calibration date. Also, the calibration date will be posted in the Results display.

Lighting & Exposure

FIGURE 3–8. Lighting & Exposure Adjustment Dialog Box

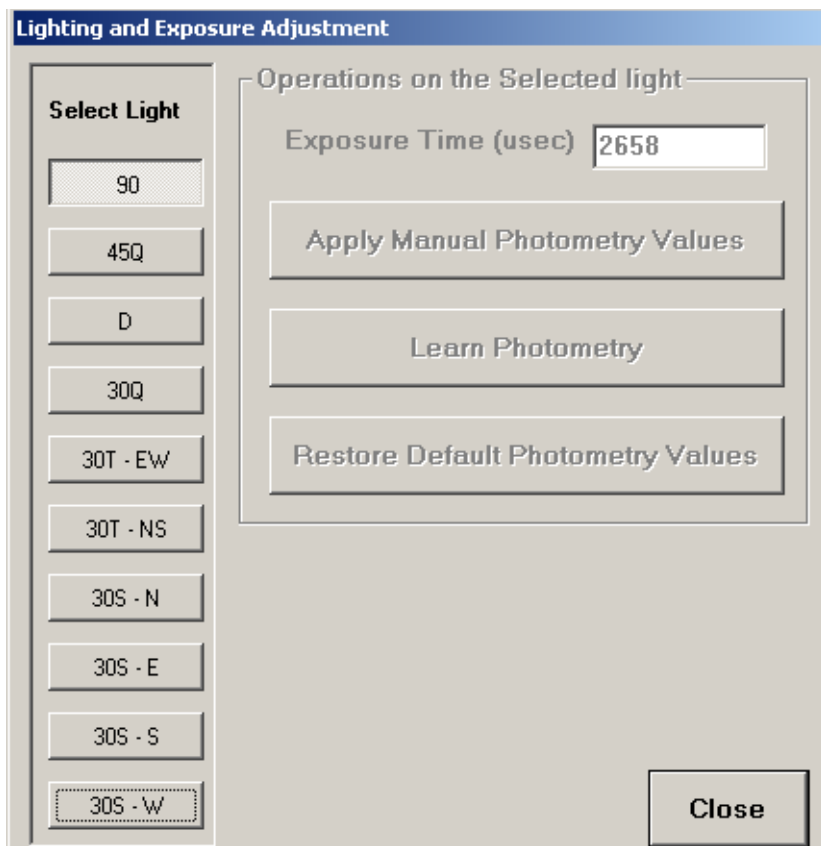

- **Select Light** — In UID-DPM, for the MIL-STD-130M/Change 1 (AIM DPM-1-2006 for DPM) or MIL-STD-130N (AIM DPM-1-2006) verification types, all supported light configurations are displayed. You can select a light configuration and use it for live video display. For other verification types in UID-DPM, only light configuration 90 is displayed and enabled. For UID-LDP, only 90 is displayed.

- Operations on the Selected Light — This group is disabled for the MIL-STD-130M/Change 1 (AIM DPM-1-2006 for DPM) or MIL-STD-130N (AIM DPM-1-2006) verification type as photometry and exposure control is done automatically in the software based on the Mean Light requirement in AIM DPM-1-2006. The Exposure Time box always displays the current exposure time used in the camera corresponding to the selected light configuration. Note that the gain values are set at the factory and will never change.

FIGURE 3–9. Lighting & Exposure Adjustment Dialog Box

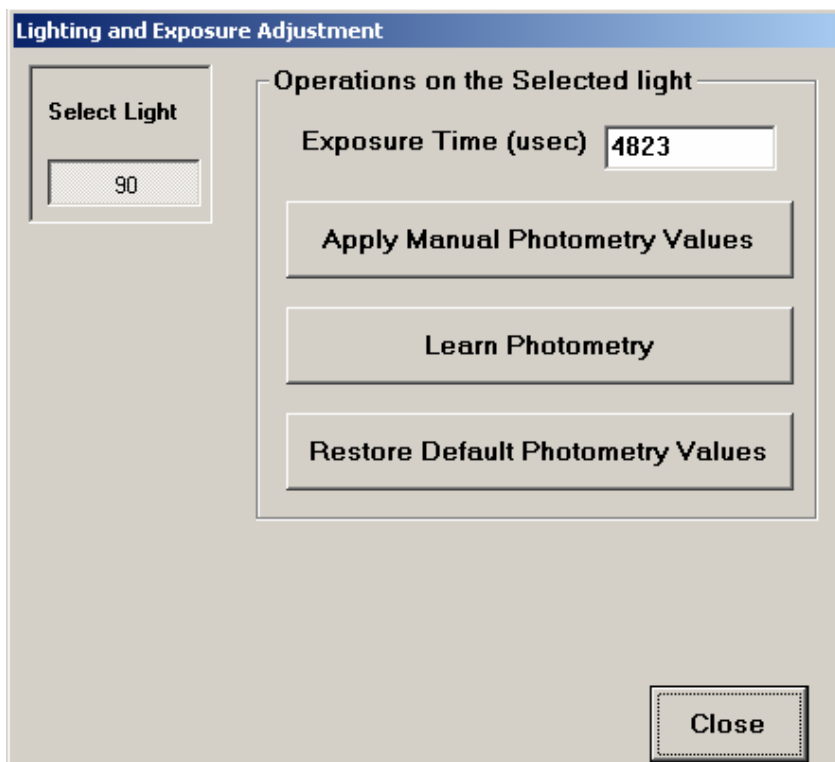

To adjust the exposure automatically, press the Learn Photometry button to obtain an image with good intensity and contrast and the new exposure time will be displayed. If the image needs further adjustment, manually enter the exposure time then select Apply Manual Photometry Values button. The Default button resets exposure time to the factory calibrated exposure time for the selected light configuration.

For the verification type MIL-STD-130M/Change 1 (AIM DPM-1-2006 for DPM) or MIL-STD-130N (AIM DPM-1-2006), Live Video automatically adjusts the exposure to produce images with acceptable contrast that allow you to correctly position the mark in the FOV. Once a Data Matrix mark is correctly positioned using one of the light configurations, the software will further adjust the exposure during the verification and the new exposure values determined by the verification algorithm for all light configurations will be available to be displayed in the Exposure Time edit box. For each light configuration, Live Video will always use the current exposure time and the verification algorithm will always start with the current exposure time and adjust it when necessary.

For all other verification types except MIL-STD-130M/Change 1 (AIM DPM-1-2006 for DPM) or MIL-STD-130N (AIM DPM-1-2006), if the image in Live Video does not have sufficient intensity or contrast, exit the Live Video and display the Lighting and Exposure Adjustment dialog box to adjust the exposure automatically or manually. Adjusting exposure will not invalidate the size calibration, but contrast will be reported as Uncalibrated until the next calibration is performed. Figure 3–10 warns you of the consequences of changing photometry values after calibration.

FIGURE 3–10. Consequences of Changing Photometry

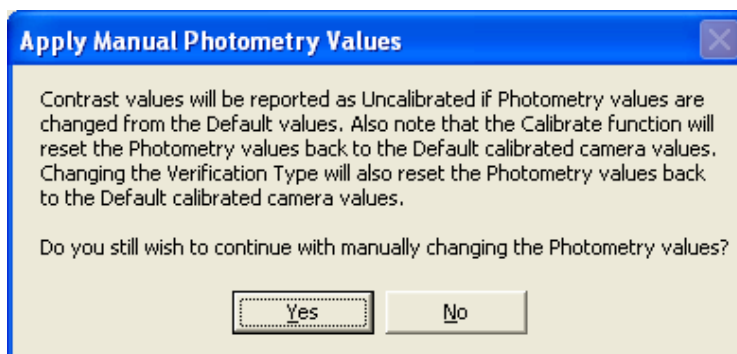

Verification Type

You must set the UIDChecker™ to use the Verification Standard most fitting to your application by using this drop down menu item. Click on Verification Type to bring up the Verification Type dialog box, as shown in Figure 3–11. The default Verification Type is MIL-STD-130N (AIM DPM-1-2006).

FIGURE 3–11. Default Verification Type

The verification types MIL-STD-130M Change 1 (AIM DPM-1-2006 for DPM) and MIL-STD-130N (AIM DPM-1-2006) have the same implementation of AIM DPM-1-2006 verification standard.

- For MIL-STD-130M Change 1 (AIM DPM-1-2006 for DPM), the grade requirement is DPM2.0/7.5-25/640/(45Q|30Q|90|30T|30S) for UID-DPM and DPM2.0/7.5-25/640/90 for UID-LDP.
- For MIL-STD-130N (AIM DPM-1-2006), the grade requirement is DPM2.0/7.5-25/640/(45Q|30Q|90|30T|30S|D) for UID-DPM and DPM2.0/7.5-25/640/90 for UID-LDP.

The difference between these two verification options is that the D (Dome) light is only available for MIL-STD-130N (AIM DPM-1-2006) for UID-DPM.

For UID-DPM, the grade requirement of DPM2.0/7.5-25/640/(45Q|30Q|90|30T|30S|D) means that the overall grade must be at least 2.0 for X dimension range 7.5-25 and wavelength 640 from at least one of the light configurations 45Q, 30Q, 90, 30T, 30S, and D.

For UID-LDP, the grade requirement of DPM2.0/7.5-25/640/90 means that the overall grade must be at least 2.0 for X dimension range 7.5-25 and wavelength 640 from the light configurations 90.

When the verification type MIL-STD-130M Change 1 (AIM DPM-1-2006 for DPM) or MIL-STD-130N (AIM DPM-1-2006) is selected, the light specified as the first one in the Light Configuration is turned on if it is not already on. (To switch to a different light angle, use the Reader > Lighting and Exposure). The following options will become available:

- Report — Two options are available:
 - Overall Grade for All Lights — When this option is selected, UIDChecker™ performs verification for each enabled light configuration and reports the result corresponding to each light configuration in a Summary Report.
 - First Passing Overall Grade — This is the default. This option can speed up the verification process. When this option is selected, UIDChecker™ performs verification for all enabled light configurations according to the specified light order. As soon as the overall grade from a light configuration meets the minimum passing grade, UIDChecker™ outputs the result without trying the remaining light configurations.
- Light Configuration — The light configuration option allows 90, 30Q, 30T, 45Q, 30S and D to be re-ordered. The Light order is listed from top to bottom. Using the “up” and “down” arrows behind each light configuration, you can adjust the light order such that certain light configurations that are more likely to produce the higher overall grade are tried first. For UID-LDP, only light configuration 90 (Diffuse perpendicular) is enabled.

When a verification type other than MIL-STD-130M Change 1 (AIM DPM-1-2006 for DPM) or MIL-STD-130N (AIM DPM-1-2006) is selected, the light configuration 90 is turned on if it is not already on for both UID-LDP and UID-DPM. No other light configurations will be available unless the verification type is MIL-STD-130M Change 1 (AIM DPM-1-2006 for DPM) or MIL-STD-130N (AIM DPM-1-2006).

When verification type MIL-STD-130L Change 1 (ISO 15415) is selected, the main buttons on the UIDChecker™ interface are as shown in Figure 3–12. The Read And Rotate button appears only when MIL-STD-130L Change 1 (ISO 15415) verification is selected. See Appendix B, “Read And Rotate,” for details.

FIGURE 3–12. Main Buttons — Read And Rotate Visible



Otherwise, the main buttons on the UIDChecker™ interface are as shown in Figure 3–13.

FIGURE 3–13. Main Buttons



Define Customer Fields

This option allows you to specify up to five lines of 80-character ASCII that will be included in the printed report and stored with each record in the log file. Also, it allows you to specify your company’s logo (.bmp file) to be included on the printed and on-screen reports. The logo should not exceed 300 pixels wide and 70 pixels high.

FIGURE 3–14. Define Customer Field Settings Dialog Box

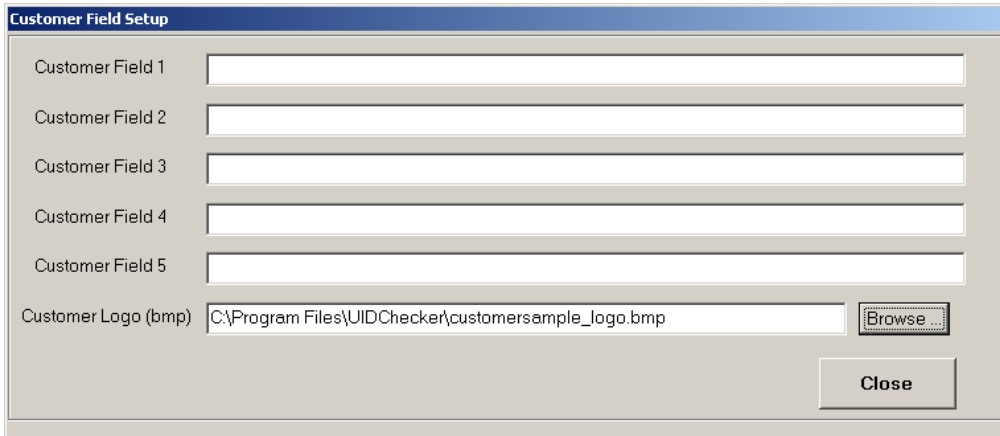

Results Setup

FIGURE 3–15. Results Setup Dialog Box

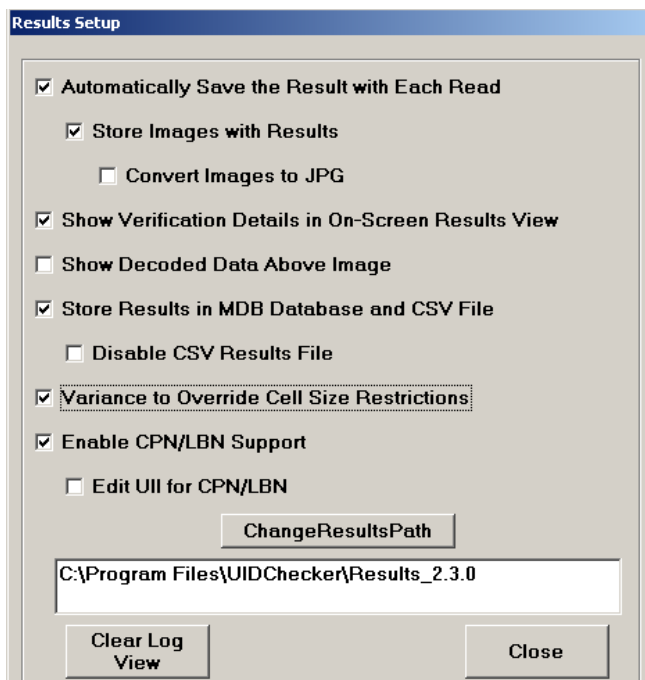

Automatically Save the Result with Each Read

This checkbox enables/disables the automatic saving of UID mark results. By default, automatic saving is disabled -- OFF.

If the option is not selected, the user is not allowed to “Store Images With Results” because there are no results to save them with. And since no images are being stored, the user is not allowed to “Convert Images to JPG”.

Store Images With Results

This checkbox enables/disables the automatic saving of the UID Mark read Image with each result. By default, automatic image storing is enabled -- ON.

Convert Image to JPG

This checkbox enables/disables the image format as JPG. When disabled, BMP image format is used.

Show Verification Details in On-Screen Results View

This checkbox enables/disables the viewing of verification and validation details. By default, this setting is disabled -- OFF.

Show Decoded Data Above Image

This checkbox enables/disables the viewing of the Decoded Data string. By default, this setting is disabled -- OFF.

Store Results in MDB Database and CSV File

This checkbox enables/disables the writing of Results to an MDB Database. By default, this setting is disabled -- OFF.

When this option is enabled, the UIDChecker™ will write the inspection results into an MDB database. This setting is saved in the registry for the user so that it is remembered the next time UID Verifier is started. The results may be read by any application, such as Access, that does not lock out writes to the database.

For customers that prefer to obtain results from an MDB database and not the CSV, comma-delimited file, an option has been provided to disable CSV Results File.

When the option Store Results in MDB Database and CSV File is de-selected, there is no CSV Results File to disable.

Note: Opening an MDB or Access in Excel locks the database so that new records can't be written by UID Verifier. In this case, a copy of the database may be created and opened.

The first time a reading is taken after enabling the database, the dialogs boxes in Figure 3–16 through Figure 3–18 are displayed to provide positive feedback that the database was created and the table within the database was created.

FIGURE 3–16. MDB Database Startup Sequence

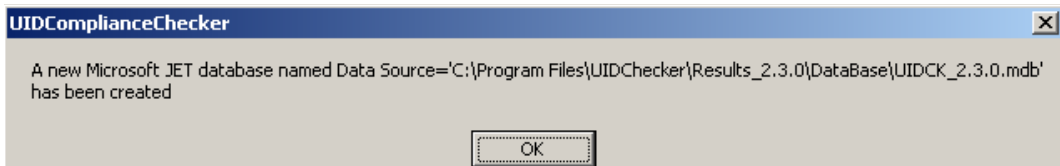

FIGURE 3–17. MDB Database Startup Sequence Continued



FIGURE 3–18. Microsoft Access View

20xClearSpace	Angle	AngleOfDistortion	AngleOfDistortionValue	Aperture	AperturePercentage	Associa
	0		16		80	
	0		16		80	
	0		16		80	

Database Table Layout

For detailed database layout, see “Version 2.3 DataBase Table Layout” on page 4-7.

Possible ADO Component Error Messages

If the ADO components on the PC where UIDChecker™ is installed are missing or a very old version, the message box in Figure 3–19 will appear.

FIGURE 3–19. Possible Error Messages if ADO is Out of Date or Missing

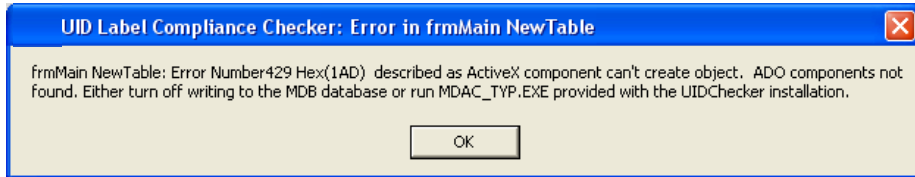

To fix this problem, see Appendix E, “Fixing ADO Components Error,” for more information.

Variance to Override Cell Size Restrictions

If you have received a variance, you can disable the test for cell size by selecting the Variance to Override Cell Size Restrictions check box, as shown in Figure 3–15.

Cell Size is still measured and reported but the results are marked with a statement that the variance is enabled, as shown in Figure 3–20.

FIGURE 3–20. Variance to Override Cell Size Restrictions Enabled

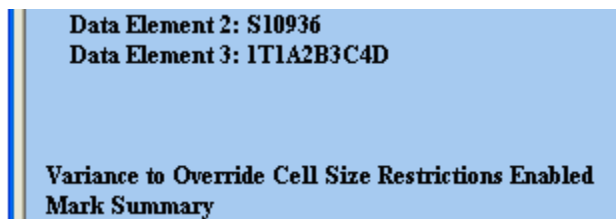

In addition, the .CSV and .MDB results will have the OverrideCellSize field set to TRUE.

Note: The variance flag has no effect on the MIL-STD-130M/Change 1 (AIM DPM-1-2006 for DPM) or MIL-STD-130N (AIM DPM-1-2006) verification type, as MIL-STD-130M/Change 1 and MIL-STD-130N require the cell size to be within 0.0075 inches and 0.025 inches.

Enable CPN/LBN Support

When this option is selected, the Associate CPN/LBN to UII frame is displayed below the image on the user interface of UIDChecker™.

FIGURE 3–21. CPN/LBN Support Selected

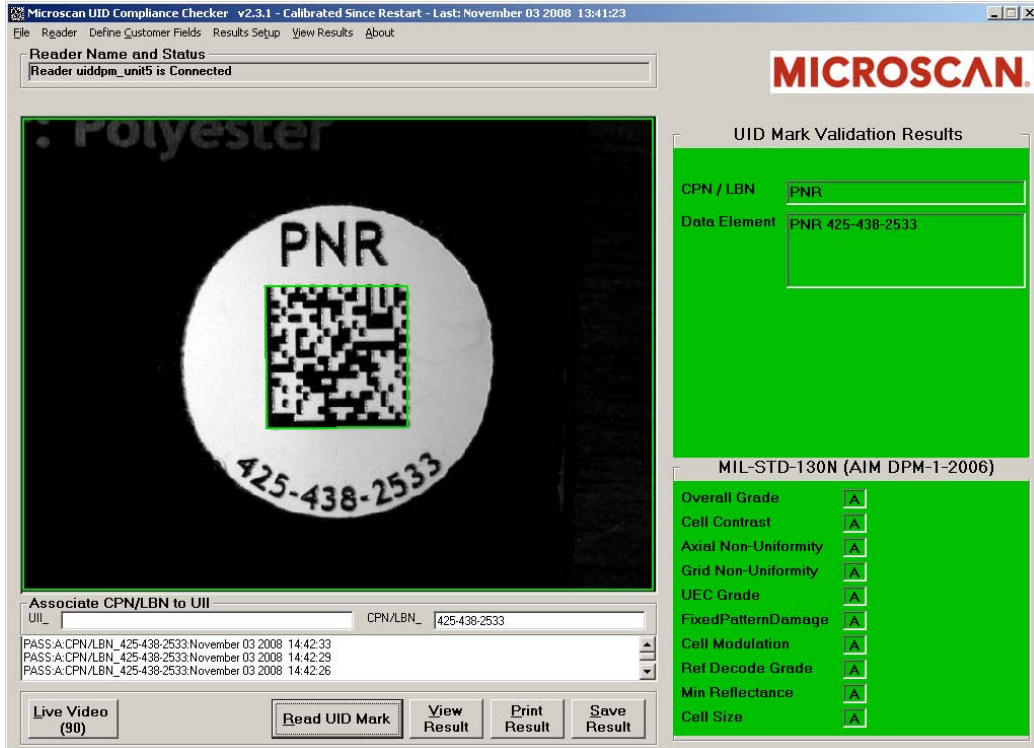

If the Enable CPN/LBN Support option is selected, and a UID mark is read, it is validated and verified the same way as if the Enable CPN/LBN Support option is de-selected. If a CPN/LBN mark is read after reading a validated UID mark, it is validated against ISO/IEC 15434 and must be of the type PNR, 30P, 240, or 30T to be considered successful. When validated, the CPN/LBN mark is reported as PNR, 30P, 240, or 30T and is associated with the last UID mark. The verification report notes the associated UII string and associated CPN/LBN, the report filename is a concatenation of UII and CPN/LBN, and the database also records the association.

If, prior to reading a CPN/LBN mark, a failure to validate a mark occurred, it is assumed that the UID mark failed to read and the CPN/LBN mark is reported

without an association to a UID mark. If the option **Edit UII** for CPN/LBN is enabled, the edit box where the UII is normally displayed becomes a writable field, and a UII may be manually entered to be associated with subsequent reads of CPN/LBN marks.

Note: It is operator's responsibility to enter the correct UII when the **Edit UII** for CPN/LBN option is used. If an incorrect UII string is entered, it will be used without validation in the verification report, file name generation, database, and CSV file. It is recommended that another reader, such as a UII validation enabled handheld, be used to generate the correct UII string.

Change Results Path

From this text box, you can redirect output files to a network drive for either backup or disaster management.

UIDChecker™ checks that protections are set correctly so that new directories can be created and results written to the remote system. If protections are not set correctly, you will see either of the messages in Figure 3–22.

FIGURE 3–22. Message(s) Displayed When Protections Not Set Correctly

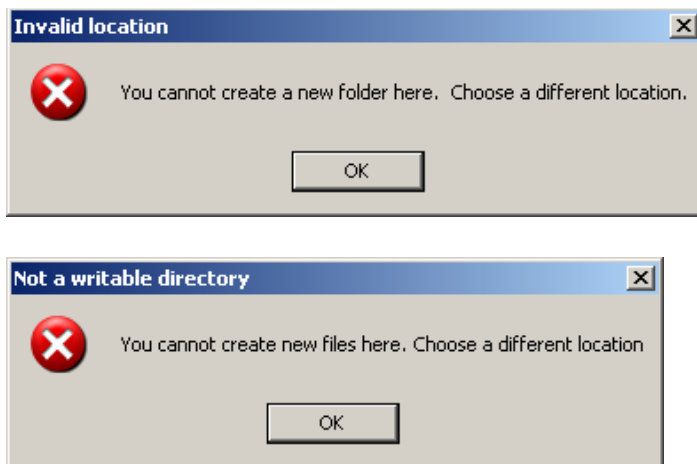

Clear Log View

This button clears or resets the Data Log View on the main screen.

Close

This button closes the Results Setup dialog.

View Results

View Results allows you to view and manage your UIDChecker™ result records. This interface can also view, search, archive, print or delete results.

Note: In version 2.3, result records are stored in the C:\Program Files\UIDChecker\Results_2.3.0 folder.

Note: In version 2.2, result records are stored in the C:\Program Files\UIDChecker\Results_2.2.0 folder.

Note: In version 2.1, result records are stored in the C:\Program Files\UIDChecker\Results_2.1.0 folder.

Note: In version 2, result records are stored in the C:\Program Files\UIDChecker\Results_2.0.0 folder.

Note: In version 1, result records were stored in the C:\Program Files\UIDChecker\Results folder .

The verification records can be viewed using a standard browser such as Microsoft Internet Explorer or through the UIDChecker™ viewer, as shown in Figure 3–23.

FIGURE 3–23. UID Compliance Verifier Results

MICROSCAN

November 04 2008 06:35:51
 UII: UN077991289420243510936

Data Validation
 UII Construct: CONSTRUCT_2
 Data Qualifier: ISO_DI
 Data Element 1: 12V077991289
 Data Element 2: 1P4202435
 Data Element 3: S10936

Raw Data: [D]<-RS>06<GS>12V077991289<GS>1P4202435<GS>S10936<RS><-EOT>

Mark Summary: Average Overall Grade / Aperture / Wavelength = .0 / 5 / 640

Results	Target Angle	Actual Angle	Overall Grade
UN077991289420243510936_Result_00000003.html	45	44	Error
UN077991289420243510936_Result_00000004.html	117	119	Error
UN077991289420243510936_Result_00000005.html	189	189	Error
UN077991289420243510936_Result_00000006.html	261	261	Error
UN077991289420243510936_Result_00000007.html	333	333	Error

Calibration: Calibrated Since Restart - Last: November 03 2008 13:41:23

Exposure=1636 Gain=290	Aperture=5	Wavelength=640
Cal. Target Contrast=82%	Calibrated Since Startup=TRUE	Pixels/Inch=556
Min/Max Raw Contrast Values=0/242	Reader Name=uidppm_unit5	SW / FW= v2.3.1.4 / 2.4.1.4

Standards:

MIL-STD-130L - 1/1/2004	MIL-STD-130L (Change 1) - 12/20/2004	MIL-STD-130M - 12/2/2005
MIL-STD-130M (Change 1) - 6/15/2007	Guide to Uniquely identifying items v1.6	DFARS 252.211-7003 - 6/2005
ISO/IEC 16022:2006	ISO/IEC 15418:2004	ISO/IEC 15418:1999
ISO/IEC 15434:2006	AIM DPM-1-2006	ANSI MH10.8.2 - 2006
ATA SPEC2000 Chapter 9	ATA CSDD	SAE AS9132A - 2/16/2005
MIL-STD-130N - 12/17/2007		

Contact Information:
www.MICROSCAN.com www.UIDSupport.com Email:UIDInfo@UIDSupport.com Phone: 1-800-251-7711

Showing Result File: Summary_00000007.html

View Search Archive

Print Result

Next Result

Previous Result

Delete Result

Back To Summary

Show Summary Results

Done

The left hand side of this screen is a web browser, which allows viewing of the saved html files. These results contain a “replaceable” Microscan logo and contact information; the read results Pass/Fail; the UII string, the detailed read validation and verification results, a picture of the just read UID mark, the read result number.

The right-hand side of this display has three tabs that allow the user to view the current results, search through the results for specific strings, and archive the results.

For the verification type MIL-STD-130M/Change 1 (AIM DPM-1-2006 for DPM) or MIL-STD-130N (AIM DPM-1-2006) with the Report mode set to Overall Grade for All Lights, you get a summary report listing the verification results for each enabled light configurations, as shown in Figure 3–24:

FIGURE 3–24. Summary Results

Microscan UID Compliance Checker - Results Viewer

Showing Result File: Summary_00000011.html

MICROSCAN.

November 04 2008 07:03:29

Mark Summary:

Results	Light	Verification Grade	Status
UN077991289420243510936_Result_00000009.html	90	4 (A)	PASS
UN077991289420243510936_Result_0000000A.html	30Q	4 (A)	PASS
UN077991289420243510936_Result_0000000B.html	30T_EW	4 (A)	PASS
UN077991289420243510936_Result_0000000C.html	30T_NS	4 (A)	PASS
UN077991289420243510936_Result_0000000D.html	48Q	4 (A)	PASS
UN077991289420243510936_Result_0000000E.html	30S_N	4 (A)	PASS
UN077991289420243510936_Result_0000000F.html	30S_E	4 (A)	PASS
UN077991289420243510936_Result_00000010.html	30S_S	4 (A)	PASS
UN077991289420243510936_Result_00000011.html	30S_W	4 (A)	PASS

Standards:

MIL-STD-130L - 1/1/2004	MIL-STD-130L (Change 1) - 12/20/2004	MIL-STD-130M - 12/2/2005
MIL-STD-130M (Change 1) - 6/15/2007	Guide to Uniquely identifying items v1.6	DFARS 252.211-7003 - 6/2005
ISO/IEC 16022:2006	ISO/IEC 15415:2004	ISO/IEC 15418:1999
ISO/IEC 15434:2006	AIM DPM-1-2006	ANSI MH10.8.2 - 2006
ATA SPEC2000 Chapter 9	ATA CSDD	SAE AS9132A - 2/16/2005
MIL-STD-130N - 12/17/2007		

Contact Information:

www.MICROSCAN.com	www.UIDSupport.com	Email:UIDInfo@UIDSupport.com	Phone: 1-800-251-7711
--	--	--	-----------------------

View Search Archive

Print Result

Next Result

Previous Result

Delete Result

Back To Summary

Show Summary Results

Done

You can click on each link to display detailed result record. To go back to the Summary report from a detailed result record, click the **Back to Summary** button.

Note: When in the summary report, the **Back to Summary** button is still enabled but clicking on it has no effect.

View Tab

The View Tab allows you to step through and review all of the UIDChecker™ Read results. You can also print and delete these records.

FIGURE 3–25. View Tab

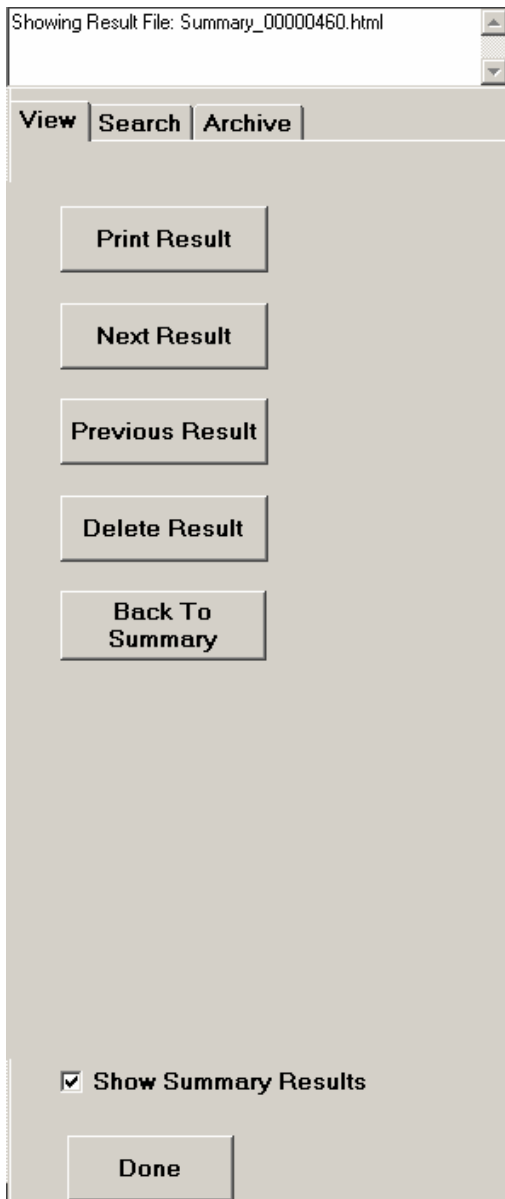

Print Result

This button allows printing of the current UID Read report to the PC's default printer. Print Results couples the last UID Mark read image, compliancy results, and the customer defined fields on to a one sheet 8 ½" by 11" printout. The user can then specify his local or network printer. These results contain contact information.

Next Result

This button allows the user to select the next HTML result for viewing. When the Result Viewer screen is launched, a list of available HTML files is created based on the files found in the "Results" folder. Clicking **Next Result** simply opens the next HTML file in the list.

Previous Result

This button allows the user to select the previous HTML result for viewing. When the Result Viewer screen is launched, a list of available HTML files is created based on the files found in the "Results" folder. Clicking **Previous Result** simply opens the previous HTML file in the list.

Delete Result

This button allows the user to delete the result currently being viewed. Clicking this button will cause the HTML file and the image file to be permanently removed from the system. An "Are You Sure" message box will prompt the user for confirmation before the result is deleted. When the result is deleted, the UIDDataLog.Dat file is modified to no longer contain the text for the deleted result.

Show Summary Results

When checked, Show Summary Results displays the summary results in the Verification report. When not checked, the verification results for each individual light configuration is displayed.

Done

This button returns the user to the main screen.

Search Tab

The following information describes the fields and buttons found on the Search Tab.

FIGURE 3–26. Search Tab

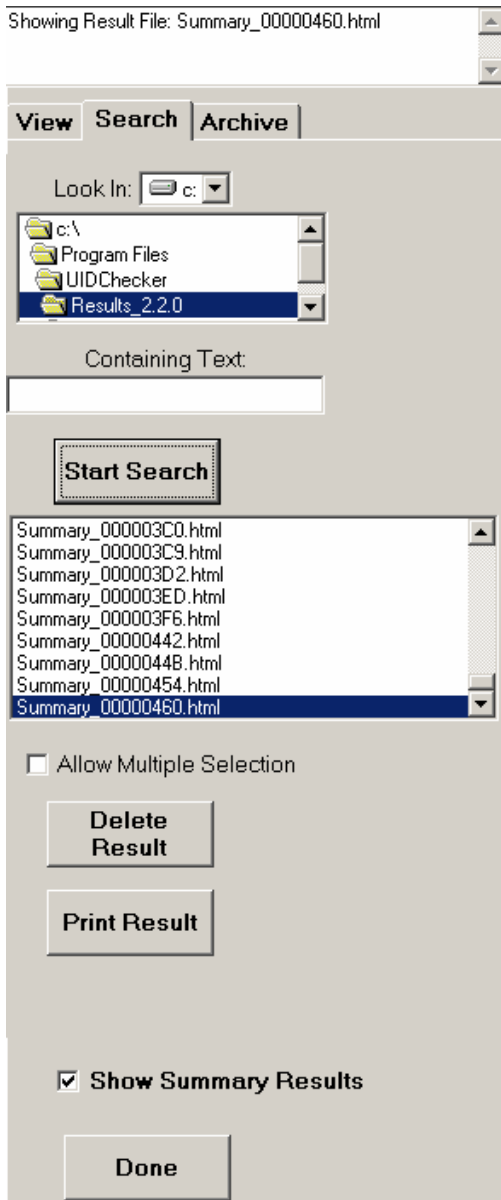

UIDChecker™
Application Details

Look In

The location for searching can be set using the “Drive” selector and “Path” selector at the top of the Search Tab.

Containing Text

This text box is where you enter the text that will be searched for. If left blank, all HTML files in the selected folder will be listed in the result list box. You can use the wildcard character “*” in your searches.

Start Search

This button initiates the search in the selected folder. Alternately, clicking on a folder in the “Path” control will initiate a search.

Result List Box

This list displays all of the HTML files that are found in the selected folder. When the Containing Text field is used, the list contains only those HTML files that contain the specified text.

Allow Multiple Selection

When this check box is not checked, clicking on a result in the Result List box causes that result to be displayed. When this box is checked, multiple results may be selected. Clicking on a result in the Result List box will not cause that result to be displayed.

Delete Result

When this button is clicked, the selected result or list of results is deleted from the system.

Print Result

This button allows printing of the result data currently shown.

Archive Tab

The following information describes the fields and buttons found on the Archive Tab.

FIGURE 3–27. Archive Tab

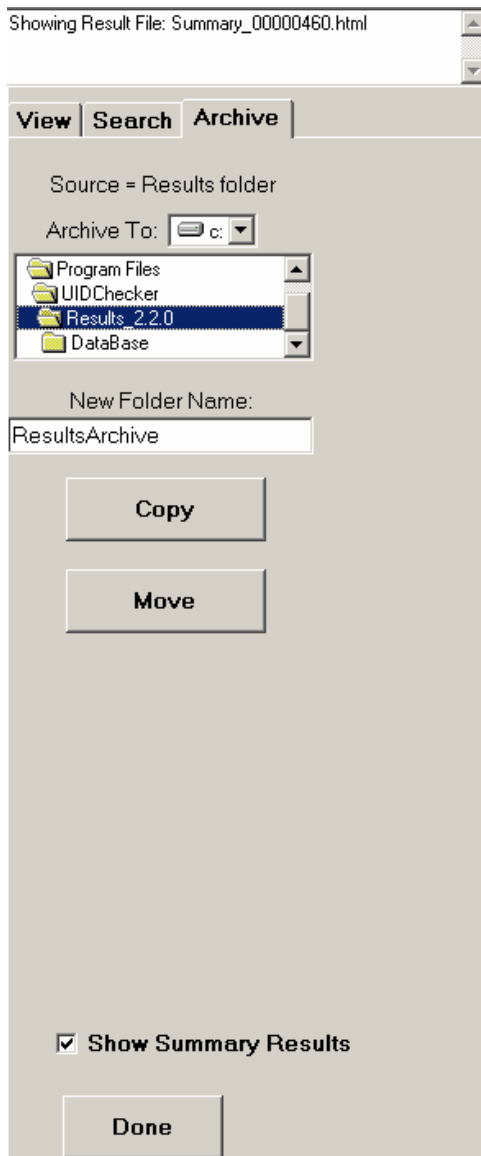

Archive To

The location to which result files are to be archived can be set using the “Drive” selector and “Path” selector at the top of the Search Tab.

New Folder Name

This text box allows the user to enter a name of a folder to archive into. If left blank, the UIDChecker™ software uses the name “ResultsArchive” for the folder name.

Copy

This button allows the user to copy all of the results in the UIDChecker\Results folder to the folder specified in the Archive To and New Folder Name settings. When duplicate files exist, the UIDChecker™ software will ask if it is OK to overwrite existing result files. When this operation is complete, the UIDChecker\Results folder will still contain the result files.

Move

This button allows the user to move all of the results in the UIDChecker\Results folder to the folder specified in the Archive To and New Folder Name settings. When duplicate files exist, the UIDChecker™ software will ask if it is OK to overwrite existing result files. When this operation is complete, the UIDChecker\Results folder will no longer contain any files.

About

View details about the UIDChecker™ application program and our contact data.

The About box displays the current software version and build number, as well as providing the customer service phone number and a link to the Microscan website. The About box also displays all the standards supported by the software.

FIGURE 3–28. About Box

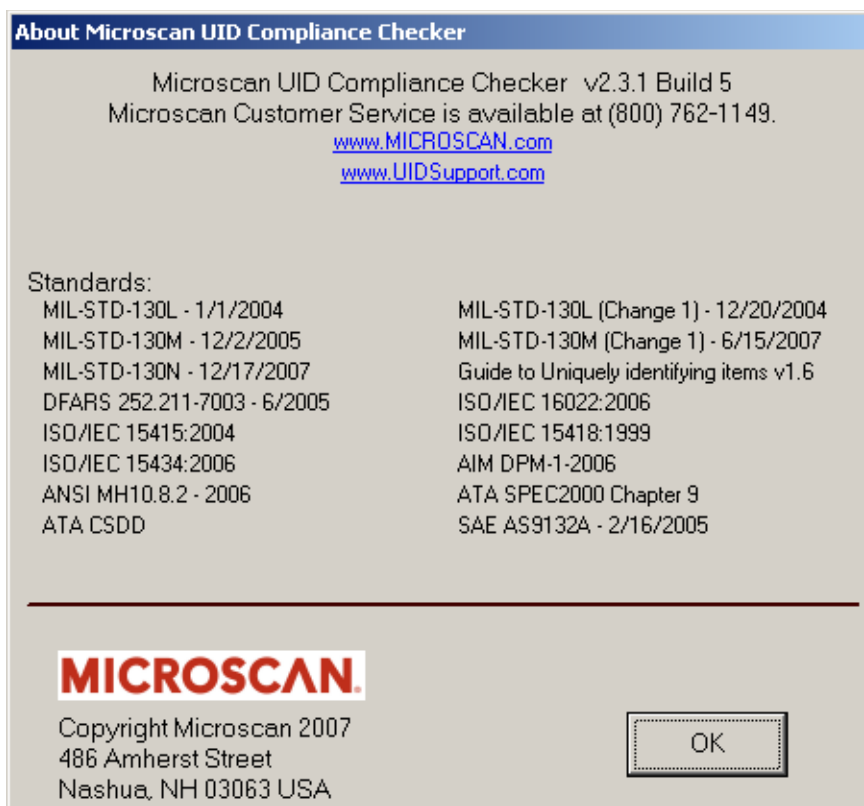

UIDChecker™ UID Mark Validation Error Messages

UIDChecker™ reports a description of the first error it encountered trying to decode the UID mark. This should help you debug your marking application. Table 3–1 is a list of potential errors generated and some suggestions for how to correct your failing UID mark.

TABLE 3-1. UII Error Codes

UII Error Code	Suggestion to Correct Problem
240 ERROR - CHARACTER	The current part number's data element character is either missing or has wrong semantics
240 ERROR - TOO LONG	The current part number is too long
240 ERROR - TOO SHORT	The current part number is too short
30P ERROR - CHARACTER	The current part number's data element character is either missing or has wrong semantics
30P ERROR - TOO LONG	The current part number is too long
30P ERROR - TOO SHORT	The current part number is too short
30T ERROR - CHARACTER	The lot/batch number's data element character is either missing or has wrong semantics
30T ERROR - TOO LONG	The lot/batch number is too long
30T ERROR - TOO SHORT	The lot/batch number is too short
DATA ELEMENT CHARACTER	The data element character is either missing or wrong semantics
DATA ELEMENT SEPARATOR	The data element separator is either missing or wrong semantics
DATA ELEMENT TOO LONG	The data element character is too long
DATA ELEMENT TOO SHORT	The data element character is too short
DOUBLE TRAILER	Remove one trailer at the end
FORMAT INDICATOR ERROR	Correct the Format Indicator (05, 06, DD, or 12)
HEADER 1ST POSITION	Correct the error in the 1st position of the header; The Mark does not appear to be a UID Mark.
HEADER 2ND POSITION	Correct the error in the 2nd position of the header
HEADER 3RD POSITION	Correct the error in the 3rd position of the header
HEADER 4TH POSITION	Correct the error in the 4th position of the header
HEADER GROUP SEPARATOR	GS is needed right after the Format Indicator
LOWER CASE CHARACTER	A lower case character was found, replace with an Upper case character.
NEED UII ELEMENT FIRST	The UII element is not at beginning of the data elements
PNR ERROR - CHARACTER	The current part number's data element character is either missing or has wrong semantics

UIDChecker™ Data Matrix Verification Error Messages

TABLE 3-1. UII Error Codes (continued)

UII Error Code	Suggestion to Correct Problem
PNR ERROR - TOO LONG	The current part number is too long
PNR ERROR - TOO SHORT	The current part number is too short
SPACE AFTER TEI DATA QUALIFIER	The TEI space is either missing or wrong semantics
TEI DATA CHARACTER	The TEI character is either missing or wrong semantics
TEI DATA QUALIFIER	The TEI data qualifier is either missing or wrong semantics
TRAILER - END OF TRANSMISSION	The trailer EOT is either missing or wrong syntax
TRAILER - RECORD SEPARATOR	The trailer RS is either missing or wrong syntax
UII ELEMENT INCOMPLETE	There is an incomplete UII element
UII STRING TOO LONG	The UII string is over 50-character limit
WRONG FORMAT INDICATOR	Correct the Format Indicator (05, 06, DD, or 12)

UIDChecker™ Data Matrix Verification Error Messages

UIDChecker™ reports the following locate/decode, and verification error messages.

TABLE 3-2. Data Matrix Locate/Decode Error Codes

Locate/Decode Error	Reason
No edge candidate found	Cannot find the any acceptable edges
First edge not found	Cannot determine the first border
Second edge not found	Cannot determine the second border
Third edge not found	Cannot determine the third border
Fourth edge not found	Cannot determine the fourth border
Four corners not found	Cannot determine all four corners
Size varying too much	Severe distortion causes size to vary too much
Row/Column test failed	Cannot determine rows or columns
Border match test failed	Border quality not acceptable
Unable to decode	Failed to decode the Data Matrix
Inspection timeout	Timed out in decoding Data Matrix

TABLE 3–3. Data Matrix Verification Error Codes

Verification Error	Reason
ISO Verification aperture too large	Data Matrix cell size is too small for the aperture 05 specified for ISO/IEC 15415
ISO Verification aperture too small	Data Matrix cell size is too large for the aperture 05 specified for ISO/IEC 15415
ISO Verification cell size greater than Max X	Cell size is greater than Max X specified for AIM DPM-1-2006.
ISO Verification cell size smaller than Min X	Cell size is smaller than Min X specified for AIM DPM-1-2006.
ISO Verification ECC200 required	ECC200 is required for ISO/IEC 15415 or AIM DPM-1-2006
ISO Verification failed RDA error correction	Failed error correction in Reference Decode Algorithm in ISO/IEC 15415 or AIM DPM-1-2006
ISO Verification failed RDA final image adjustment	Failed the final image adjustment step in AIM DPM-1-2006
ISO Verification failed RDA STEP A E	Failed Reference Decode Algorithm in steps A through E in ISO/IEC 15415 or AIM DPM-1-2006
ISO Verification failed RDA STEP F 1	Failed Reference Decode Algorithm in step F 1 in ISO/IEC 15415 or AIM DPM-1-2006
ISO Verification failed RDA STEP F 2	Failed Reference Decode Algorithm in step F 2 in ISO/IEC 15415 or AIM DPM-1-2006
ISO Verification failed RDA STEP F 3	Failed Reference Decode Algorithm in step F 3 in ISO/IEC 15415 or AIM DPM-1-2006
ISO Verification insufficient space	There is insufficient space surrounding the Data Matrix for ISO/IEC 15415 or AIM DPM-1-2006.

UID Read Result Data Details

In this chapter, you will learn more about examining and managing your UID Read results. First, the on-screen data presentation will be explained, then the data log file will be explained. Refer to “View Results” starting on page 3-28 for an overview of the UID Mark Read Results.

Analyzing the Results of UIDChecker™

If the Data Matrix mark is a valid UID mark and is verified to be of good quality, then both the Validation and Verification panels at the right of the screen will become green, as shown in Figure 4–1. The light on top of the unit will also show green.

FIGURE 4-1. UIDChecker — Passed UII — Good Quality

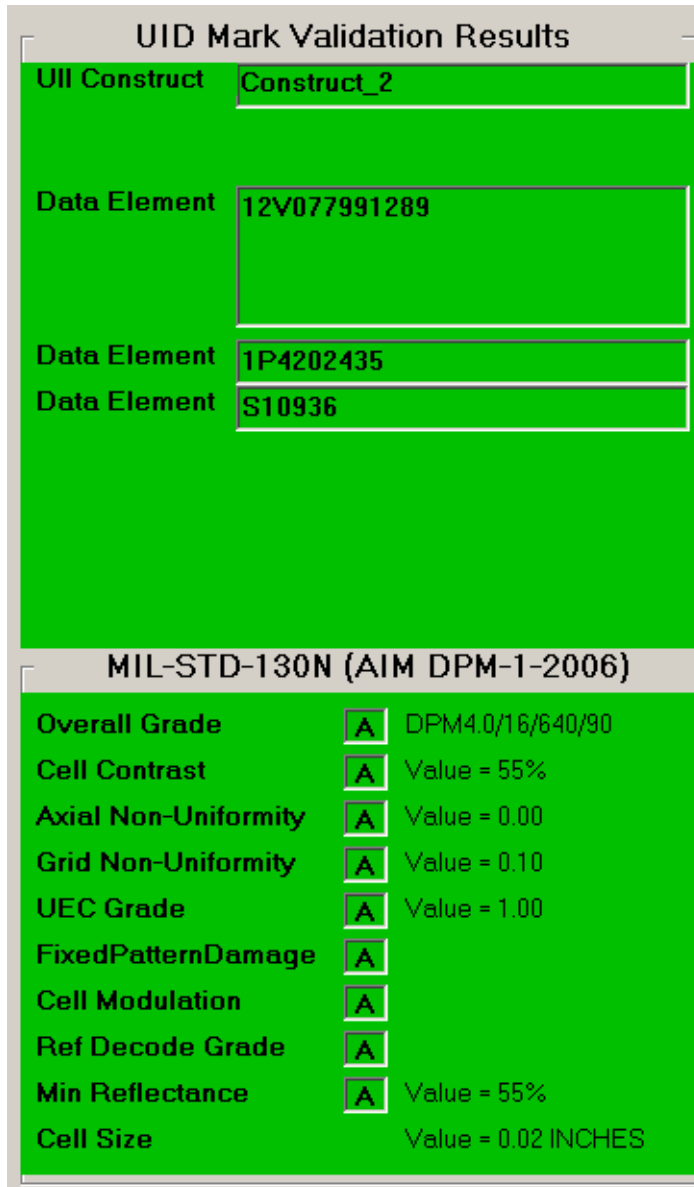

If either the validation or the verification test failed, the appropriate panel will be red, as shown in Figure 4–2. The light on top of the unit will also show red.

FIGURE 4–2. UIDChecker — Passed UII — Bad Quality

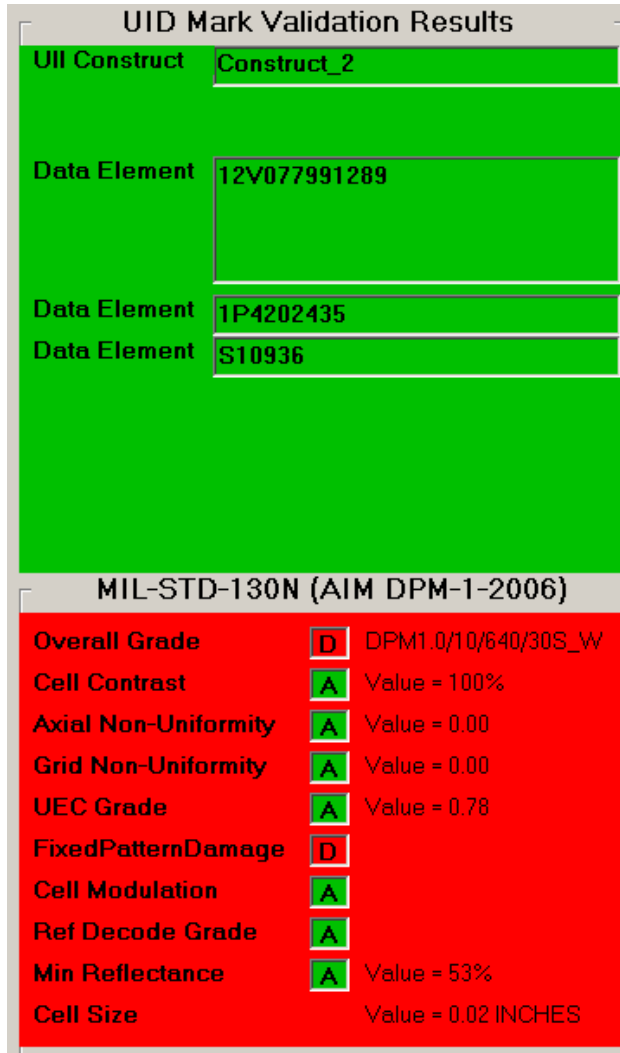

If the UID mark is valid, then the validation results panel reports the UID mark components. As long as the Data Matrix can be decoded and verified, the verification panel shows the grading on each of the quality tests. The

UIDChecker™ provides an overall pass/fail using green/red background color based on the standard you select.

For detailed descriptions of the Data Matrix Verification, please consult the HawkEye™ 1500 Series Verification Manual.

Figure 4–3 through Figure 4–9 show various possible UII validation results. For each figure, the on-screen result is shown on the left and the corresponding UID Read Report is shown on the right.

Figure 4–3 displays the results of a valid UII Data Matrix. Note that the Data Qualifier is available in the UID Read Report.

FIGURE 4–3. Data Validation — Valid UII

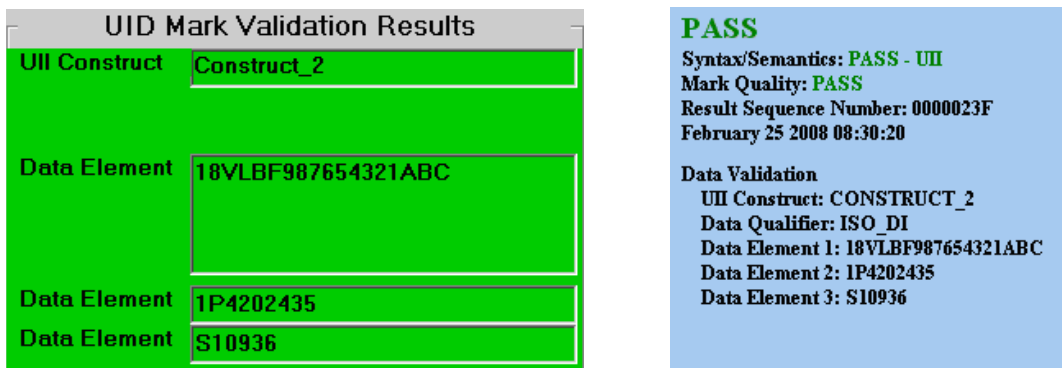

Figure 4–4 displays the results of a valid PNR Data Matrix with the option “Enable CPN/LBN Support” enabled.

FIGURE 4–4. Data Validation — Valid CPN/LBN

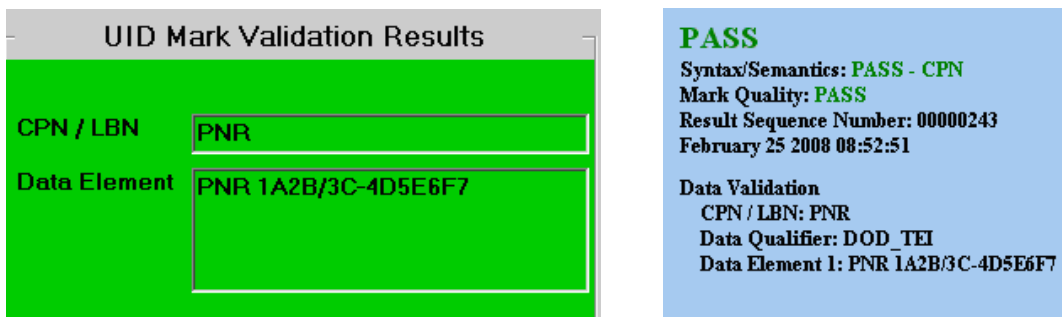

Figure 4–5 displays the results of an invalid UII Data Matrix due to an 15434 error.

FIGURE 4–5. Data Validation — 15434 Error in UID Validation

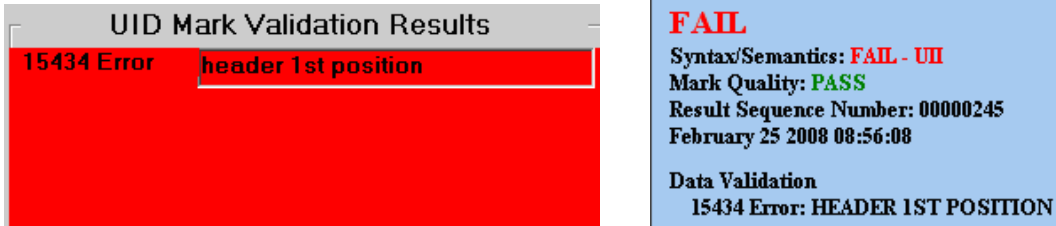

Figure 4–6 displays the results of an invalid UII Data Matrix due to a UII data element error.

FIGURE 4–6. Data Validation — UII Error in UID Validation

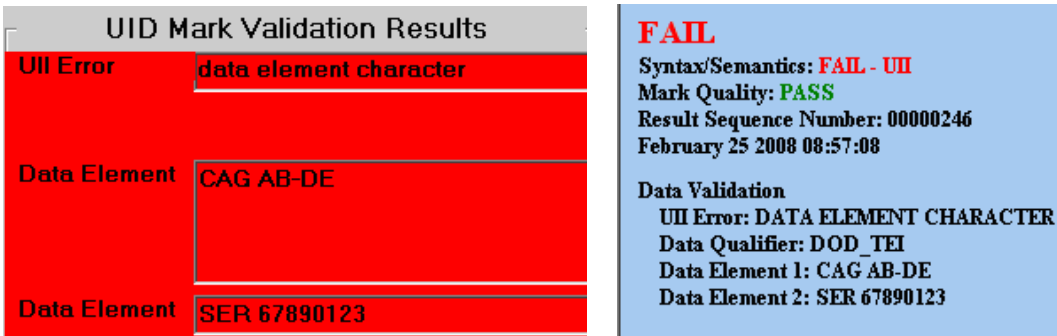

Figure 4–7 displays the results of an invalid 240 Data Matrix with the option “Enable CPN/LBN Support” checked.

FIGURE 4–7. Data Validation — CPN Error in UID Validation

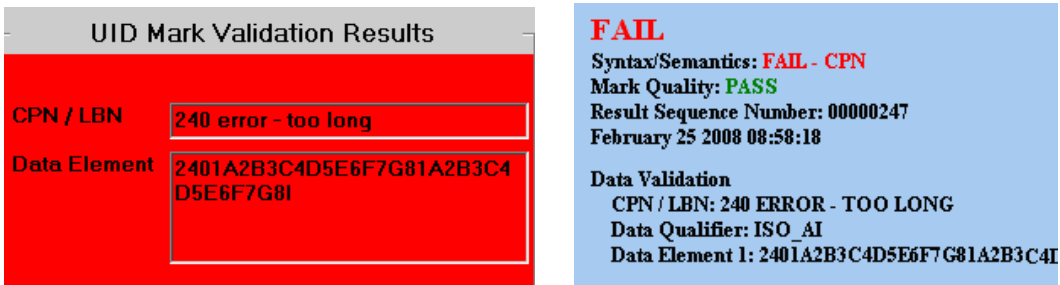

Figure 4–8 displays the result of validating a valid PNR Data Matrix without checking the “Enable CPN/LBN Support” option.

FIGURE 4–8. Data Validation — UII Error for a Valid CPN

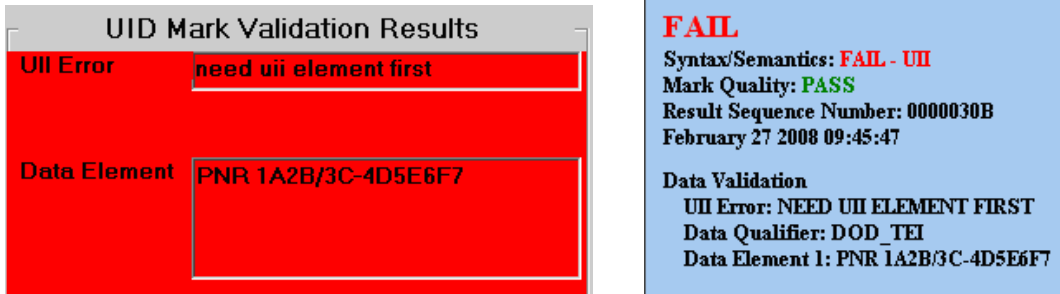
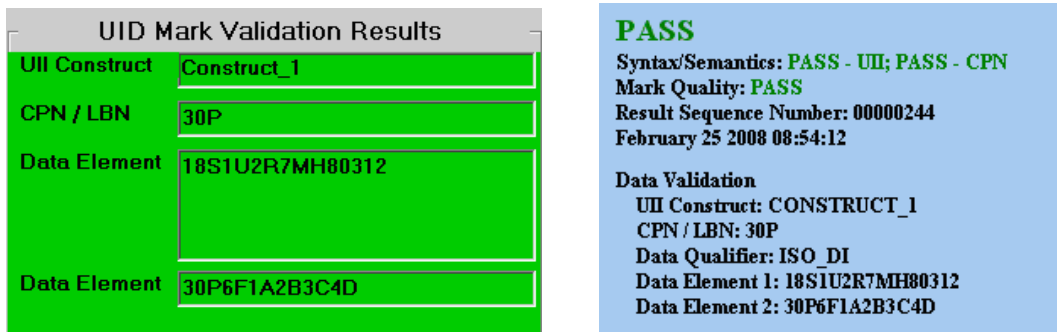

Figure 4–9 displays validation results of UII and 30P in the same Data Matrix when both UII and 30P are valid. Note that “Enable CPN/LBN Support” is checked.

FIGURE 4–9. Data Validation of UII & 30P in a Single Data Matrix



UID Results Data File

When a read result is saved, the UIDChecker™ software generates a unique number that gets incorporated into the name of the result and image files. This number is an 8 digit hexadecimal number starting at the number “00000000”. For each saved result, this number gets incremented by 1. The last number used gets stored in the system registry so that, when the UIDChecker™ application is launched again, the next number to be used can be retrieved from the system registry.

Please consult “Store Results in MDB Database and CSV File” on page 3-23 to enable the writing of UID mark reading results to the CSV file and MDB database.

Version 2.3 UIDDataLog_2.3.0.csv File Format

The following is a detailed listing of the comma-delimited contents for a version 2.3 data file. Using this description, you should be able to transfer the data into your local Excel program or a database.

Due to the complexity of parsing rules for the results as presented in the comma-delimited results file, results are now provided in the same alphabetical order as in the MDB database record and each field is prefixed with a tag name in the form “<tag name>,” to make parsing easier. All fields are always written, even if empty. The following shows the first several fields in the CSV file:

```
<20xClearSpace>,FALSE,<Angle>,68,<AngleOfDistortionGrade>,,<AngleOfDistortionValue>,,<Aperture>,5,...
```

Version 2.3 DataBase Table Layout

The database table layout is shown in Table 4–1:

TABLE 4–1. Version 2.3 Database Table Layout

Variable	Size
20xClearSpace	VarChar(32)
Angle	int
AngleOfDistortionGrade	VarChar(4)
AngleOfDistortionValue	int
Aperture	VarChar(8)
AperturePercentage	int
AssociatedCpnLbnString	VarChar(128)
AssociatedUIIString	VarChar(128)
AxialNonUniformityGrade	VarChar(4)
AxialNonUniformityValue	Double
CalBlackOffset	VarChar(16)
CalExposure	int
CalGain	int

TABLE 4-1. Version 2.3 Database Table Layout (continued)

Variable	Size
Calibrated	VarChar(64)
CalibratedSinceStartup	VarChar(64)
CalMeanLight	int
CalTargetContrast	int
CalTargetReflectanceMax	int
CellSizeError	VarChar(16)
CellSizeGrade	VarChar(4)
CellSizeValue	Double
CellUnitReportString	VarChar(8)
Construct	VarChar(32)
ContrastGrade	VarChar(4)
ContrastReportString	VarChar(32)
ContrastValue	int
ConvertImagesToJPG	VarChar(8)
CurrentLight	VarChar(32)
CurvedPart	VarChar(8)
CustomerFields1	VarChar(132)
CustomerFields2	VarChar(132)
CustomerFields3	VarChar(132)
CustomerFields4	VarChar(132)
CustomerFields5	VarChar(132)
DataElement1	VarChar(64)
DataElement2	VarChar(64)
DataElement3	VarChar(64)
DataElement4	VarChar(64)
DataElement5	VarChar(64)
DataElement6	VarChar(64)
DataElement7	VarChar(64)
DataQualifier	VarChar(64)
DotCenterOffsetGrade	VarChar(4)
DotCenterOffsetValue	int

TABLE 4–1. Version 2.3 Database Table Layout (continued)

Variable	Size
DotSizeOffsetGrade	VarChar(4)
DotSizeOffsetValue	int
ECCLevel	VarChar(8)
EditUIIforCpnLbn	VarChar(8)
EnableCpnLbnSupport	VarChar(8)
Exposure	int
FirmwareRev	VarChar(12)
FixedPatternDamageGrade	VarChar(4)
Gain	int
GridNonUniformityGrade	VarChar(4)
GridNonUniformityValue	Double
HTMLFileName	VarChar(255)
ImgFileName	VarChar(255)
LastUIIString	VarChar(128)
Logo	VarChar(255)
MatrixHeightValue	Double
MatrixSizeError	VarChar(16)
MatrixSizeGrade	VarChar(4)
MatrixWidthValue	Double
MaxRawContrastValue	int
MeanLight	int
MinRawContrastValue	int
MinReflectanceGrade	VarChar(4)
MinReflectanceValue	int
ModulationGrade	VarChar(4)
ModuleFillGrade	VarChar(4)
ModuleFillXValue	int
ModuleFillYValue	int
NominalModuleSizeGrade	VarChar(4)
NominalModuleSizeValue	Double
OvalityGrade	VarChar(4)

TABLE 4-1. Version 2.3 Database Table Layout (continued)

Variable	Size
OvalityValue	int
OverallGrade	VarChar(4)
OverrideCellSize	VarChar(8)
PixelsPerInch	int
PrintGrowthGrade	VarChar(4)
PrintGrowthXValue	int
PrintGrowthYValue	int
RawData	VarChar(255)
ReaderName	VarChar(32)
ReferenceDecodeGrade	VarChar(4)
SecureCamera	VarChar(8)
SequenceNumber	VarChar(12)
SoftwareRev	VarChar(12)
TimeofLastResult	date
UnusedErrorCorrectionGrade	VarChar(4)
UnusedErrorCorrectionValue	Double
Valid240Pass	VarChar(8)
Valid30PPass	VarChar(8)
Valid30TPass	VarChar(8)
ValidAndVerifPass	VarChar(8)
ValidateFailure	VarChar(128)
ValidISO15434Pass	VarChar(8)
ValidPNRPass	VarChar(8)
ValidUIIPass	VarChar(8)
VerificationPass	VarChar(8)
VerificationType	VarChar(64)
VerifyFailure	VarChar(128)
VerifyReadPass	VarChar(8)
Wavelength	int
XDimensionMax	int
XDimensionMin	int

FIGURE 4–10. Microsoft Access View

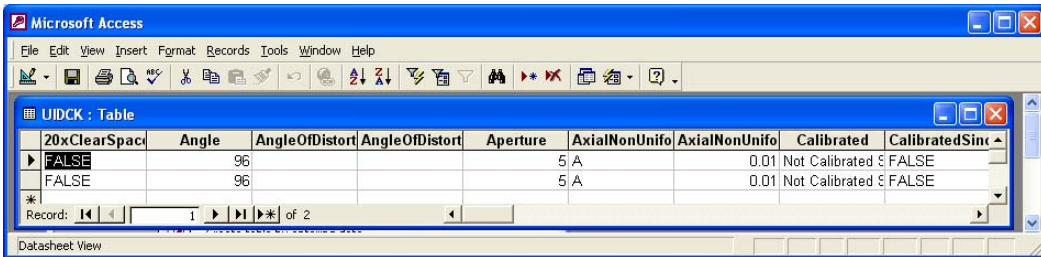

Understanding UID Mark Quality

Data Matrix Cell Size

The UIDChecker™ has been configured to read marks of the size range that is specified by revisions L, L Change 1, M, and M Change 1 of MIL-STD-130. These marks with cell sizes in the 0.0075 to 0.025 inch range can be decode reliably and verified by the UIDChecker™ using UID-LDP and UID-DPM. Microscan can't guarantee reliable performance of the standard UID-LDP and UID-DPM on marks with cell sizes outside this range. For applications outside this range, please contact Microscan for special hardware setup and application support.

ECC 200

The UIDChecker™ has been configured to read UID marks made with ECC 200. If a UID mark does not use ECC200, it is not a valid UID mark and the UIDChecker™ will fail the validation of the UID mark.

Data Matrix Quality Verification Standard

All supported verification standards are explained in detail in the HawkEye™ 1500 Series Verification Manual.

Upgrading to UIDChecker™ V2.1

If the version of your UIDChecker is older than Version 2.1, please follow this appendix to upgrade to Version 2.1 first. Then, you can follow “Upgrading the UIDChecker™ Software from V2.1” on page 1-13 to upgrade to the latest UIDChecker™ Version 2.2.

With Version 2.1 of the UIDChecker™, a DPM Verification License and UID-CK license are required on the UID-CK hardware. A check occurs at UIDChecker™ startup to ensure that the DPM Verification License and UID-CK license are present on the camera. If you have version 2.1 or later UID-CK, your unit has been pre-configured at the factory for these license keys.

If you are a current user of a v2.0 (or previous) UID-CK, you must perform several steps to upgrade to v2.1. Contact Microscan to get a document with all the steps for upgrading, including assigning your verification and UID licenses keys. After confirming you as a customer, Microscan will e-mail you the software key and instructions to perform the upgrade to V2.1. An overview of the upgrade instructions are shown below. Refer to the document that accompanies your software keys for the latest directions.

1. Launch ReadRunner from the Start Menu
(Start > All Programs > ReadRunner 2.2 > ReadRunner).
2. Take control of your UID-CK.
3. Open the terminal window and type:

```
Set_license {Microscan provided software license Key}
```

We advise you to “cut & paste” the software key from this e-mail into the ReadRunner utility to set the license.

After setting the license keys, you can now install the UID-CK software.

Put the Microscan Tools Drive in a USB port on your computer and run Setup. The automated program will prompt you to:

1. Uninstall the older version of UIDChecker™ software. Just follow the prompts and click OK.

Note: It will not delete your results!

2. Uninstall the older version of HawkEye’s ReadRunner - this is the code that talks to the UID-CK unit. Again, just follow the prompts and click OK.
3. Install the new version of HawkEye’s ReadRunner. Just follow the prompts and click OK.
4. Install the UIDChecker™ software. Just follow the prompts and click OK.

Before using the UIDChecker™ software, you need to upgrade the firmware on the UID-CK unit. Follow these directions to upgrade the UID-CK unit before you start the UIDChecker™ software:

1. Install the HawkEye™ software as part of the usual installation process - as directed above.
2. From the Start Menu, select **Programs > ReadRunner 2.2 > Utilities > Hawkeye Flasher**.

The HawkEye Flasher dialog box is displayed, as shown in Figure A-1.

FIGURE A-1. Upgrade the HawkEye™ Flasher Dialog Box

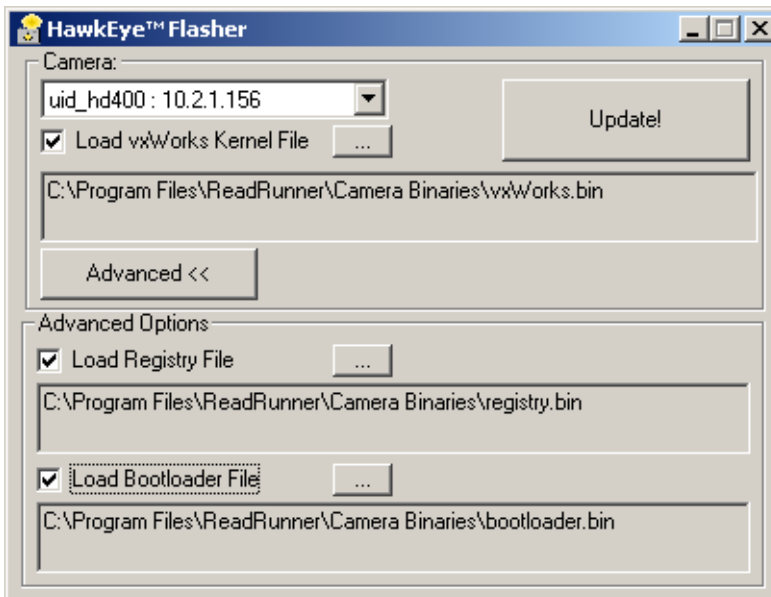

3. In the drop down list of “Cameras”, select your UID-CK and make sure you enable (check) all the check boxes for:
 - Load VxWorks Kernel
 - Load Registry File
 - Load Bootloader.
4. Click Update!

When “Done” appears at the bottom of the terminal display, the process is complete and you can now start the UIDChecker™ software.

Read And Rotate

The **Read And Rotate** button is visible when you select the MIL-STD-130L Change 1 (ISO/IEC 15415) Verification Type. You use **Read And Rotate** to test for rotational consistency of measurements.

Read And Rotate allows you to position your UID Code and read/rotate it five times at 72° intervals. Use **Live Video** to position a mark in the FOV of the reader.

Notes: The Data Matrix must be completely within the screen for a successful read.

The hardware trigger button is disabled to support **Read And Rotate**.

Read And Rotate Usage Details

1. Specify the Verification Type to be ISO/IEC 15415 in the Verification dialog box, as shown Figure B-1.

FIGURE B-1. Setting Verification Type to Invoke Read And Rotate

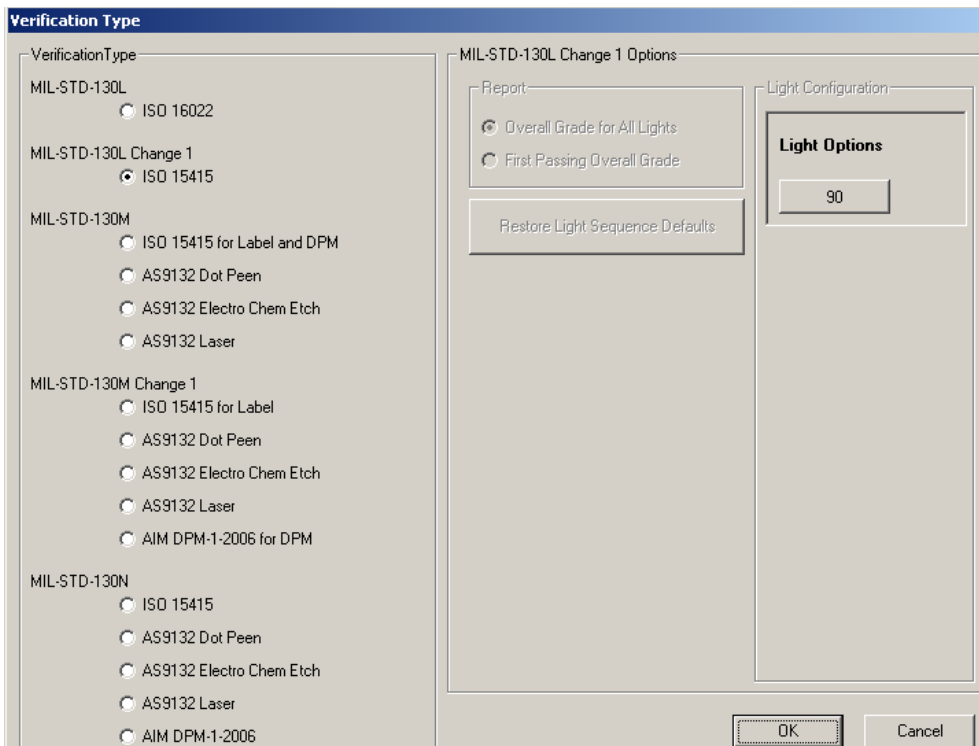

2. Click OK. The Read And Rotate button will appear on the main interface.
3. Click Read And Rotate. Notice the following:
 - The Live Video button is activated.
 - The Read And Rotate button becomes the Cancel Read And Rotate button.
 - The chevrons displayed on the main Read And Rotate window (Figure B-2).

FIGURE B-2. Initial Read And Rotate Screen

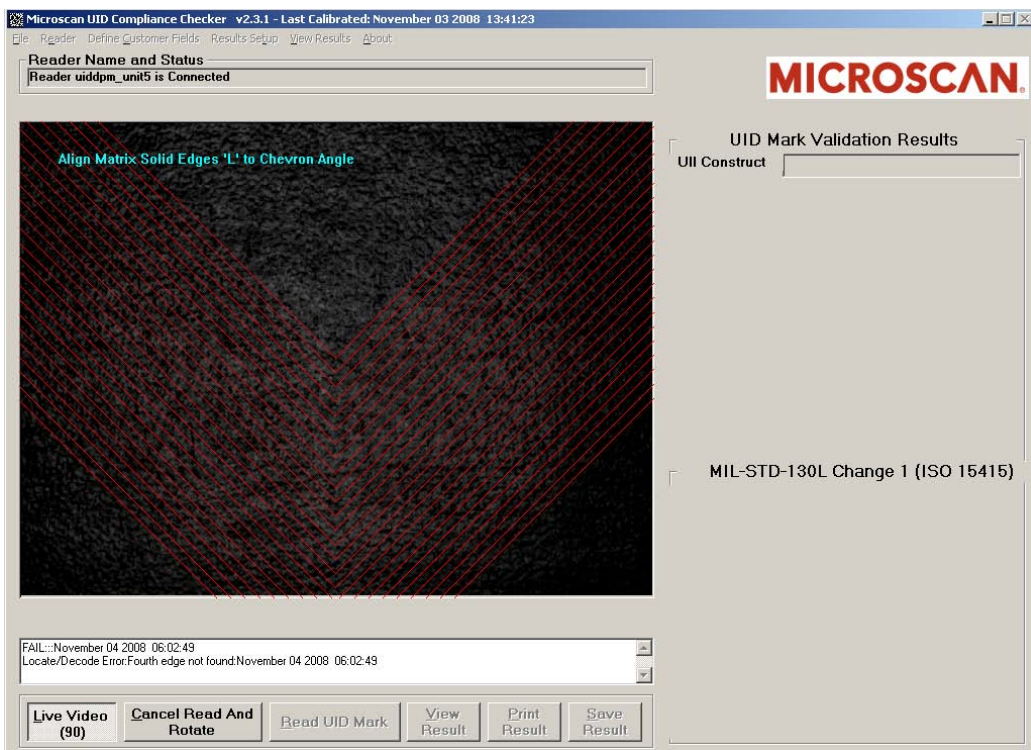

4. Align the Data Matrix solid edges to the chevron angle. This works best when you carefully line up the “L” of the Data Matrix as close to the on-screen “Chevron Angle,” as shown in Figure B-3.

B

Read And Rotate

FIGURE B-3. Read And Rotate First Read

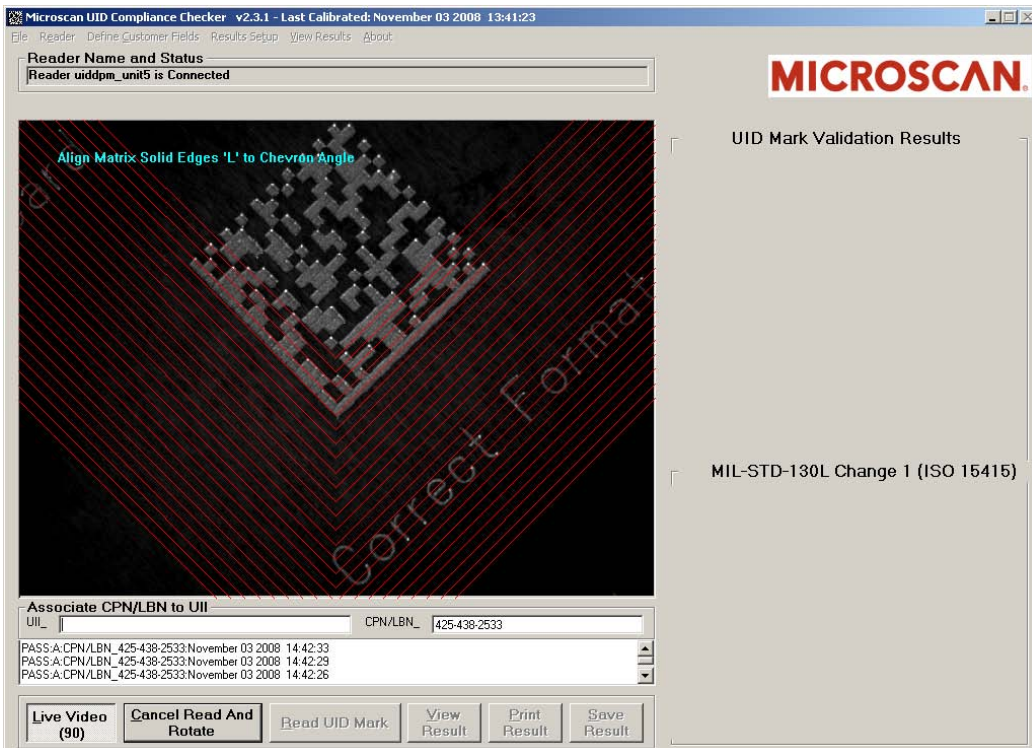

5. After you have the Data Matrix in position, click Live Video.
If the Data Matrix is aligned correctly, the unit beeps and the chevrons are rotated 72°.
6. Align the Data Matrix solid edges to the new chevron angle.
7. After you have the Data Matrix in position, click Live Video.
8. Continue this process three more times, aligning the Data Matrix solid edges to the new chevron angle. When you have aligned the Data Matrix a total of five times, the Live Video button is no longer active (depressed), and a screen similar to the one in Figure B-4 is displayed.

Note: To cancel out of Read And Rotate, click the Cancel Read And Rotate button.

FIGURE B-4. Read And Rotate Last Read

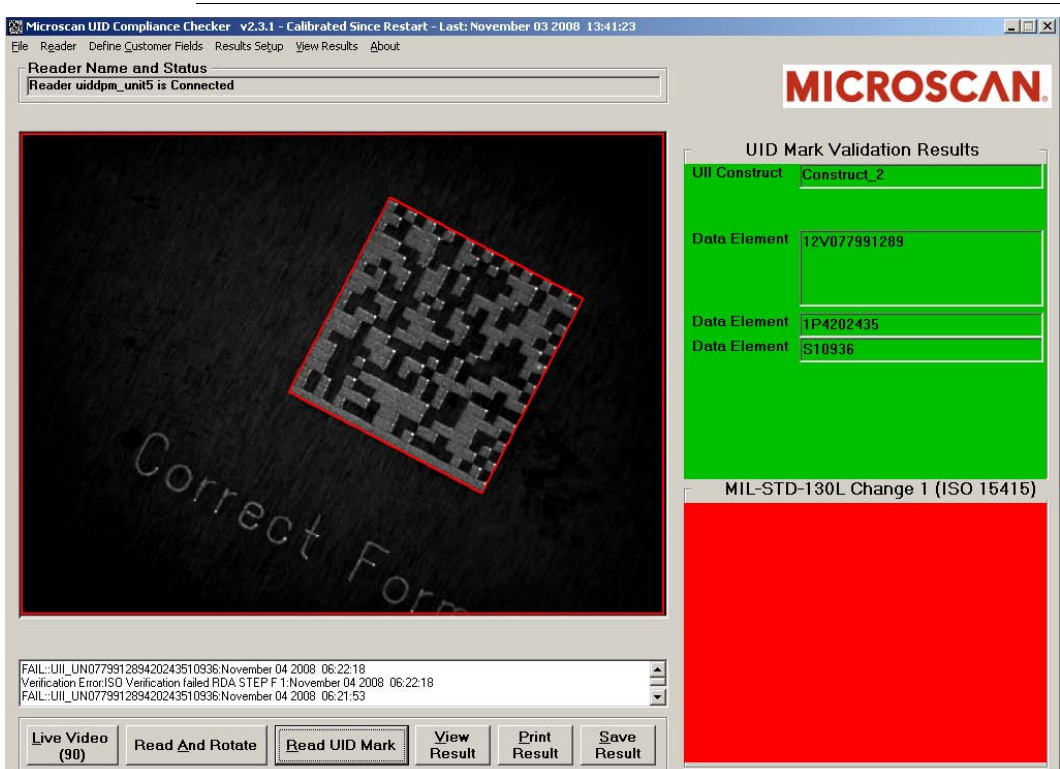

9. Save your Results if you have not already done so.
10. Click on View Results to see a Summary Report, if you want to.

B

Read And Rotate

FIGURE B-5. Read And Rotate Summary Report

MICROSCAN

November 04 2008 06:35:51
 UID: UN077991289420243510936

Data Validation
 UID Construct: CONSTRUCT_2
 Data Qualifier: ISO_DI
 Data Element 1: 12V077991289
 Data Element 2: 1P4202435
 Data Element 3: S10936

Raw Data: <D>-<RS>-06-<GS>-12V077991289-<GS>-1P4202435-<GS>-S10936-<RS>-<EOT>

Mark Summary: Average Overall Grade / Aperture / Wavelength = .0 / 5 / 640

Results	Target Angle	Actual Angle	Overall Grade
UN077991289420243510936_Result_00000003.html	45	44	Error
UN077991289420243510936_Result_00000004.html	117	119	Error
UN077991289420243510936_Result_00000005.html	189	189	Error
UN077991289420243510936_Result_00000006.html	261	261	Error
UN077991289420243510936_Result_00000007.html	333	333	Error

Calibration: Calibrated Since Restart - Last: November 03 2008 13:41:23

Exposure=1636 Gain=290	Aperture=5	Wavelength=640
Cal. Target Contrast=82%	Calibrated Since Startup=TRUE	Pixels/Inch=556
Min/Max Raw Contrast Values=0/242	Reader Name=uidrpm_unit5	SW / FW= v2.3.1.4 / 2.4.1.4

Standards:

MIL-STD-130L - 1/1/2004	MIL-STD-130L (Change 1) - 12/20/2004	MIL-STD-130M - 12/2/2005
MIL-STD-130M (Change 1) - 6/15/2007	Guide to Uniquely identifying items v1.6	DFARS 252.211-7003 - 6/2005
ISO/IEC 16022:2006	ISO/IEC 15415:2004	ISO/IEC 15418:1999
ISO/IEC 15434:2006	AIM DPM-1-2006	ANSI MH10.8.2 - 2006
ATA SPEC2000 Chapter 9	ATA CSDD	SAE AS9132A - 2/16/2005
MIL-STD-130N - 12/17/2007		

Contact Information:
www.MICROSCAN.com www.UIDSupport.com Email:UIDInfo@UIDSupport.com Phone: 1-800-251-7711

Clicking on any of the file names in the table will take you to the individual read results for the five successful read and verifications.

Attaching UID-DPM to UID-DPM Stand

Setting Up the UID-DPM Stand

FIGURE C-1. Dowel Pins & Thumb Screw

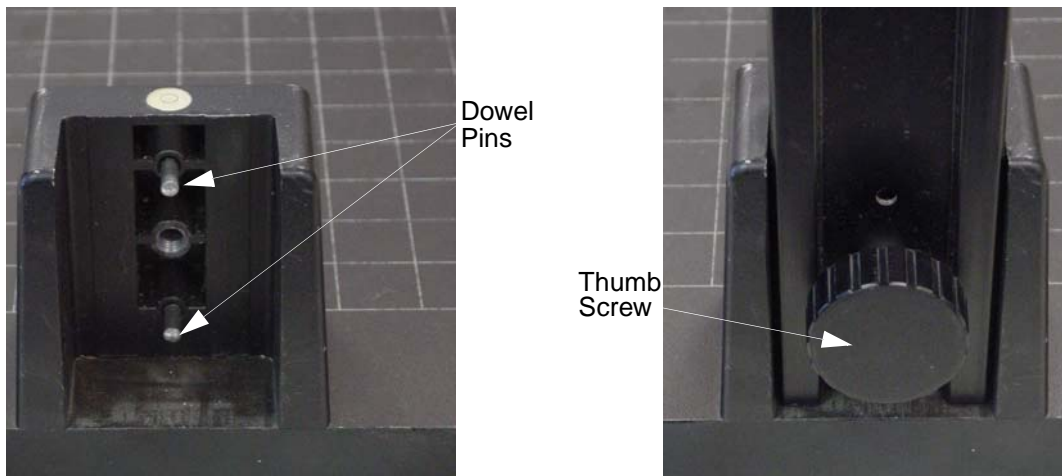

1. Remove the stand base and upright arm from the packaging.
2. Place the base on a level flat surface.
3. Slide the upright arm onto the two dowel pins in the back of the base.

Appendix C Attaching UID-DPM to UID-DPM Stand

4. Fasten the upright arm using the large thumb-screw provided with the kit.
5. Be careful while moving the upright arm. The camera mounting head is spring-loaded and can move while carrying the arm.

Attaching the UID-DPM

Use the following procedure to attach the UID-DPM to the UID-DPM stand:

1. Rotate the arm so that it is in the position shown in Figure C–2.

FIGURE C–2. Correct Position of Arm



2. Move the bolt on the arm to the correct position before you try to attach the UID-DPM (see Figure C–3).

FIGURE C-3. Move Bolt to Correct Position

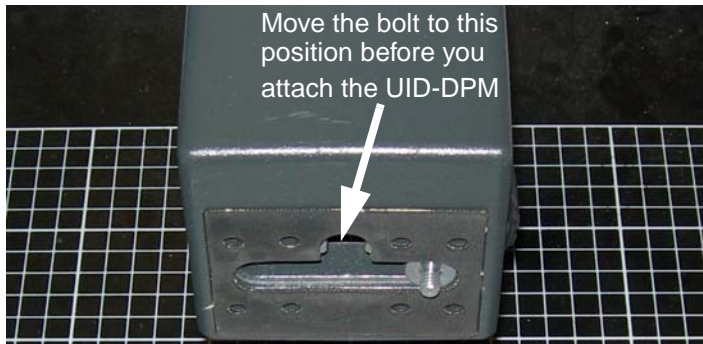

3. Attach the UID-DPM, making sure that all four feet fully contact the base of the UID-DPM stand.
4. Using one foot of the UID-DPM, set up the correct stand-off distance for the direct part mark you want to verify, as shown in Figure C-4.

FIGURE C-4. Setting Up Correct Stand-Off Distance



5. Slide the part into the FOV, as shown in Figure C-5.

FIGURE C-5. Part in the Field of View



6. Center the Data Matrix mark using Live Video, as shown in Figure C-6.

FIGURE C-6. Centering Data Matrix Using Live Video

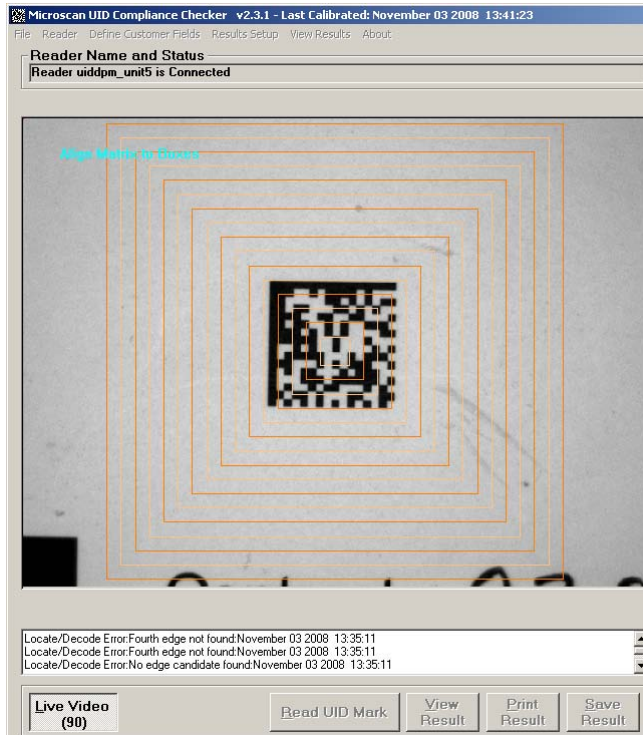

Upgrading UID-DPM001 w/UIDChecker Software V2.3

Before you upgrade your UID DPM Compliance Kit (UID-DPM001), make sure you have the following parts.

1. HawkEye 1510 camera with serial cable (FIS-HE15-0CS0)
2. AC power cable for camera (P/N HEPS-1500)
3. DOAL-50 V2, R(660) LED-D
4. AC power cable for light (P/N CPS-12)
5. DOAL-50 mounting hardware HELTMA-4L (98-LG17-0XX0)
6. C-mount lens 25mm (P/N 928-0057-4) or 35mm (P/N 928-0057-5)
7. Extension ring (P/N C0206)
8. UID stand (98-UA10-0ST0)
9. Ethernet cable (P/N HEENET-007)
10. Thumb screws (4) to attach light mount to the camera (P/N 972-0282-1)
11. Calibration Test Card (98-UA10-0CC0)
12. UID Checker installer (Microscan Tools Drive: 37-000010-01)

13. Ethernet crossover adapter (P/N HEENET-XLA)
14. Spiral wire wrap (P/N 966-0195-1)

Setting Up the UID-DPM Stand

FIGURE D-1. Dowel Pins and Thumb Screw

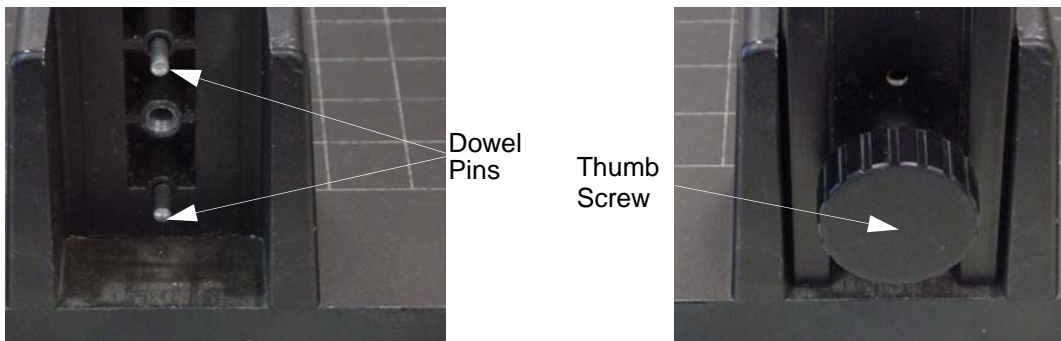

1. Remove the stand base and upright arm from the packaging.
2. Place the base on a level flat surface.
3. Slide the upright arm onto the two dowel pins in the back of the base.
4. Fasten the upright arm using the large thumb screw provided with the kit.
5. Be careful while moving the upright arm. The camera mounting head is spring-loaded and can move while carrying the arm.

Attaching the Camera

1. Attach the HawkEye™ 1510 camera to the stand using the ¼-20 thumb screw that protrudes from the front of the camera mount head.
2. Connect the HEPS-1500 power cable to the camera.
3. Plug the HEPS-1500 power cable into a 110V outlet.
4. Connect the HEENET-007 network cable to the camera.

5. Loop the power and Ethernet cable in the wire hook on the back rear of the camera mounting head.

Assembling the Lights

FIGURE D-2. HELTMA-4L Bracket



1. Assemble the HELTMA-4L to the DOAL-50 using two M6x10mm screw.

Preparing the Lenses

1. Take the lenses out of their boxes and remove the plastic over-wrap. Store the lenses with the lens covers on.
2. Remove the extension tubes from the box and remove plastic over-wrap.

3. Remove the lens protective cap from the bottom of the HawkEye™ 1510 camera.

Attaching the Lights to the Camera

FIGURE D-3. Small Hole Caps

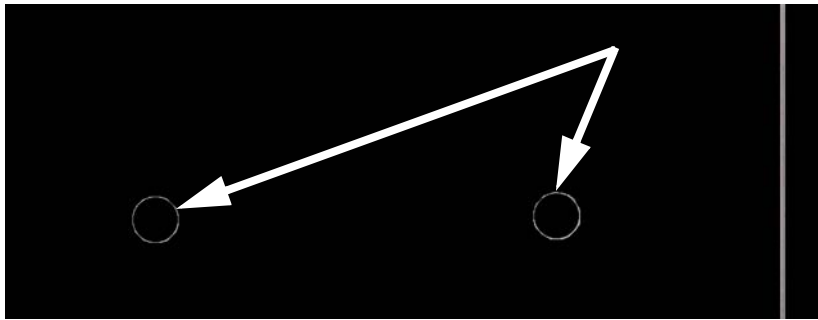

1. Using a small screwdriver, remove the 4 small hole caps (two on each side) on the sides of the HawkEye™ camera.

FIGURE D-4. Thumb Screws

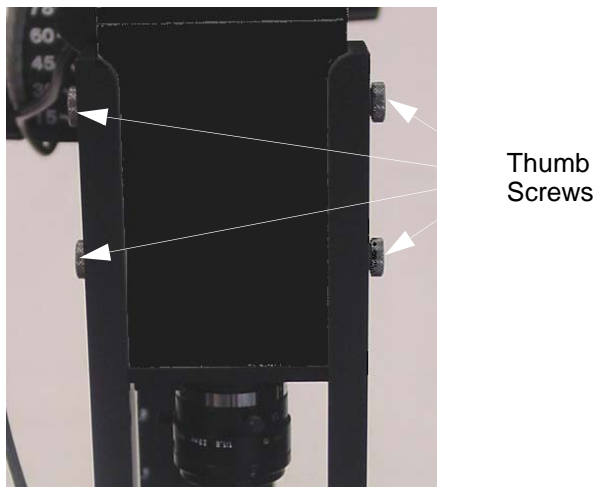

2. Using the 4 thumb screws provided, attach the HELTMA-4L bracket to the HawkEye™ camera.

Recommended Verifier Setting with 25mm Lens

3. Plug the CPS-12 power supply into a 110V outlet and attach the DB-9 connector to the light attached to the HELTMA bracket.
4. Center the light on the camera by loosening the four button head screws on the side of the HELTMA and centering the light.

Recommended Verifier Setting with 25mm Lens

f-stop = 2

Extension Ring = 6mm

Distance from front of camera to part = 8 inches (203.2 mm)

Distance from bottom of light to part = 2 inches (50.8 mm)

Field of View = 1.19 inches x 0.86 inches (30.2 mm x 21.8 mm)

FIGURE D-5. Setting 1 — 25mm Lens with 6mm Extension Ring

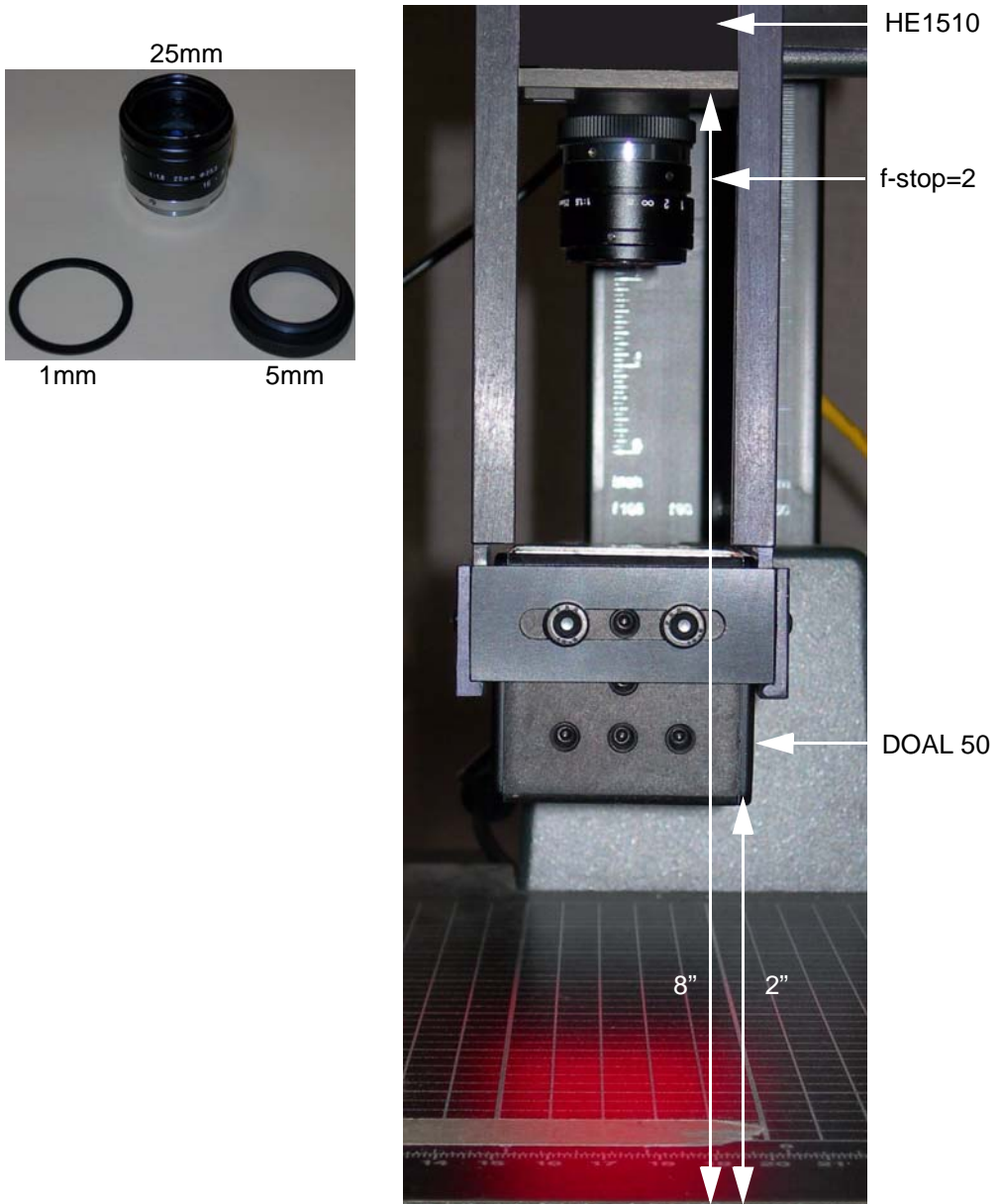

Recommended Verifier Setting with 35mm Lens

f-stop = 3

Extension Ring = 10mm

Distance from front of camera to part = 9 inches (228.6 mm)

Distance from bottom of light to part = 2 inches (50.8 mm)

Field of View = 0.89 inches x 0.67 inches (22.6 mm x 17.0 mm)

FIGURE D-6. Setting 2 — 35mm Lens with 10mm Extension Ring

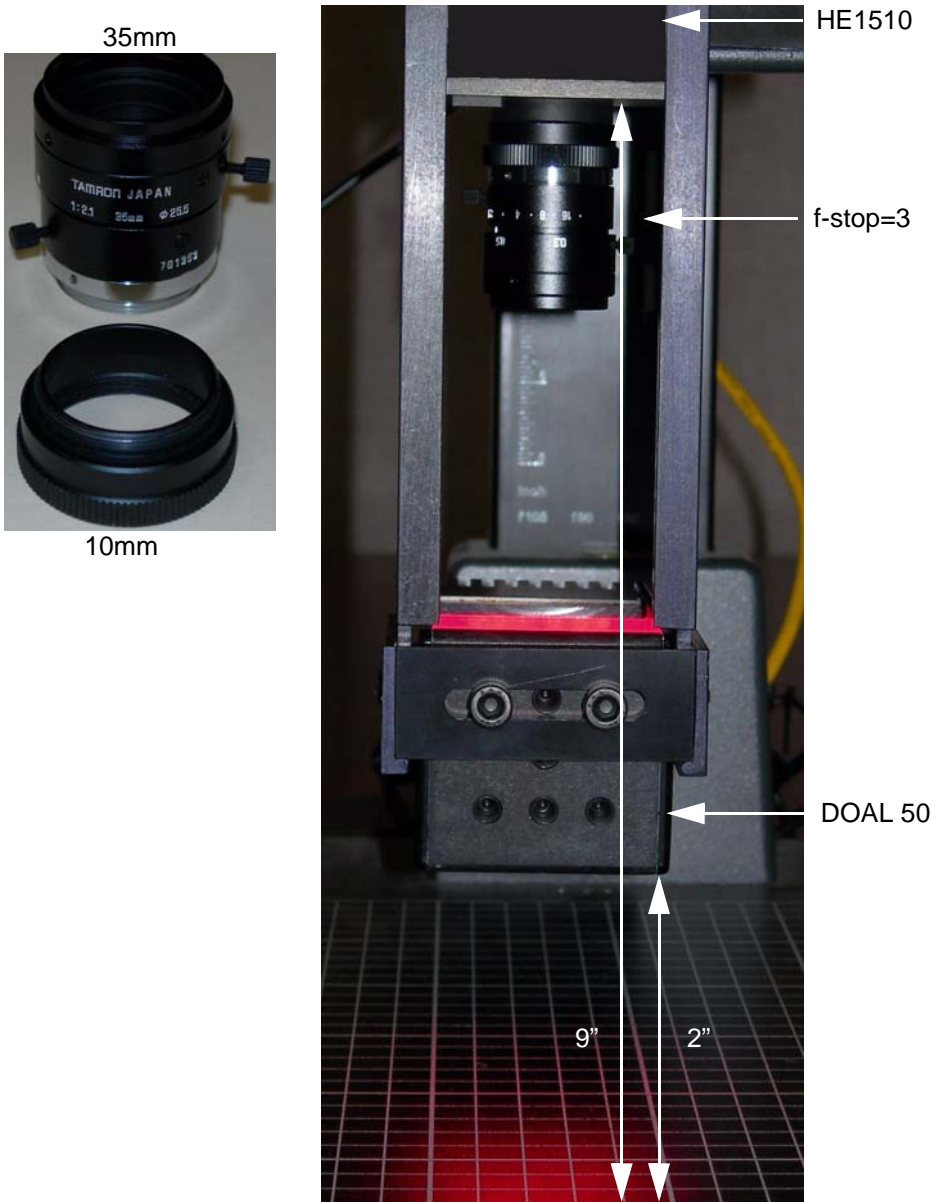

Setting Up the Network

FIGURE D-7. HEENET-XLA Ethernet Crossover Adapter



1. If you are not using a company LAN or a router between the camera and PC, you can use the included HEENET-XLA Ethernet crossover adapter.

Note: Do not use the crossover adapter if you are using a router, switch, or company LAN.

2. Follow “Networking to the UID-LDP & UID-DPM” on page 1-10 for setting up DHCP or static IP communications between your camera and PC.

Upgrading the Software

1. Configure the hardware to Setting 1 or 2, based on the lens used.
2. Power up the HawkEye 1510 with Ethernet cable and RS-232 serial cable connected.
3. Install UIDChecker v2.2 to the PC and use the HawkEye_flasher to upgrade the camera firmware.

Configuring the Verifier

The verifier needs to be configured every time the firmware is updated.

1. Run HyperTerminal and configure the COM port to 115200, 8, Parity None, Stop bits 1, Flow control None.
2. Select the Connect icon to make the serial connection.

3. Type `Ctrl-P` to get the prompt `>`.
4. Type `CONTROL`.
5. Type `XLIGHTCHANNELS 1`.
6. For DOAL-50 with wavelength 660nm, type `WAVELENGTH 660`.
7. Type `SAVE BOOT`.
8. Type `RELEASE`.
9. Type `Ctrl-P`.
10. Click the Disconnect icon to disconnect.

HawkEye Sensor/Lighting Normalization

To normalize the sensor response with respect to the lighting setup, use the HawkEye Normalization tool:

1. Go to `\Program Files\UIDChecker\Utilities`.
2. Double click `HawkEyeNormalization.exe`.

The screen in Figure D–8 is displayed.

FIGURE D–8. HawkEye Normalization Tool

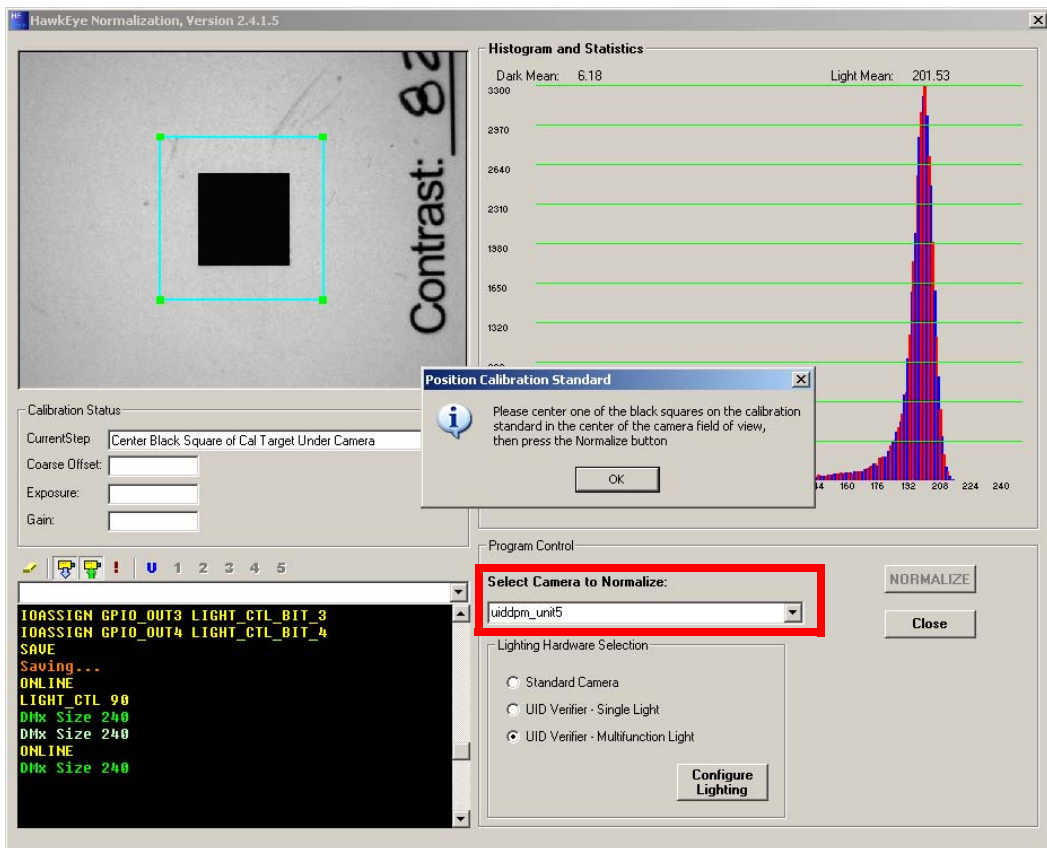

3. In the Select Camera to Normalize drop down list box, select the correct UID verifier camera or enter the IP address of the camera.
4. Position the Calibration Test Card such that the black square is in the center of the light blue square. Click OK on the Position Calibration Standard dialog box. Click NORMALIZE.

For UID Verifier - Multifunction Light, the normalization can take 10 minutes to complete.

Reflectance Calibration

Perform reflectance calibration (see “Perform Reflectance Calibration” on page 2-3).

You are now ready to use the upgraded verifier system that supports MIL-STD-130N and AIM DPM-1-2006.

Fixing ADO Components Error

To fix an ADO components error, the latest version (2.8 sp1) of MDAC_TYP.EXE from Microsoft has been provided on the UID Compliance Checker installation disk. Run MDAC_TYP.EXE to update the ADO components.

These are the components already installed with Windows XP SP2, so it is unnecessary to update a Windows XP SP2 system.

FIGURE E-1. MDAC_TYP.EXE to Fix ADO Error Under XP



Under Windows 2000, run the MDAC_TYP.EXE utility to update the ADO components, and you will see the dialog boxes in Figure E-2, Figure E-3, and Figure E-4.

FIGURE E-2. Run MDAC_TYP.EXE Under Win2K, Click Next

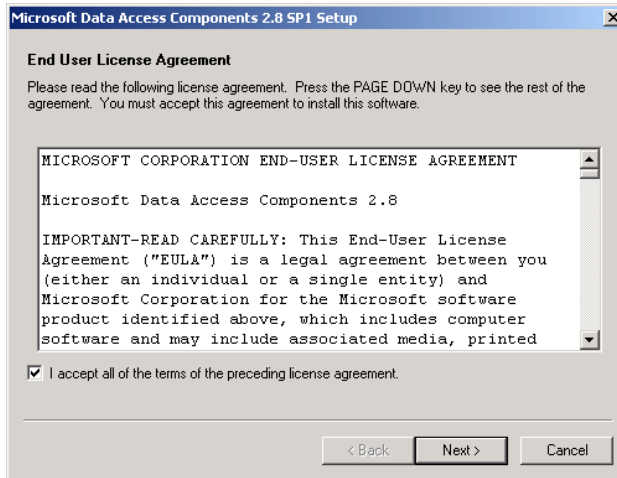

FIGURE E-3. MDAC_TYP.EXE Fix ADO, Click Finish

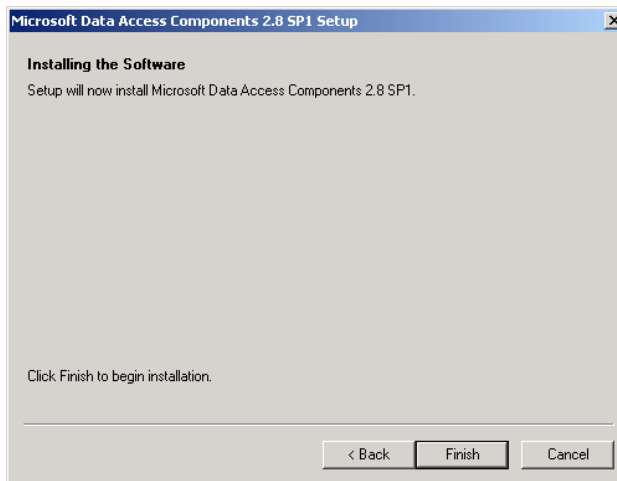
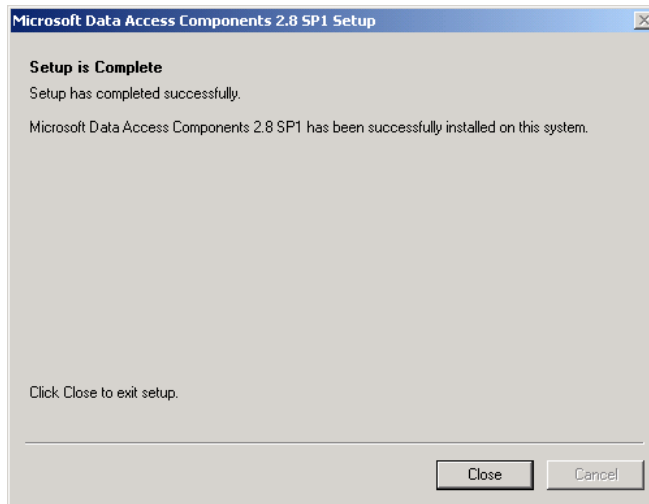

FIGURE E-4. MDAC_TYP.EXE to Fix ADO Error Complete



Data File Formats for UIDChecker Software

For completeness, we will detail the comma-delimited read data log file from both Version 1 and Version 2 software. In the latest software, with the new Verifications now supported in the UIDChecker™ software and the enhanced reporting of the read data, the format of the Results has changed slightly. In particular, the log file, UIDDataLog.Dat, has changed.

- “Version 1.0 UIDDataLog.Dat File Format” starting on page F-1
- “Version 2.0 UIDDataLog.Dat File Format” starting on page F-4
- “Version 2.1 UIDDataLog.csv File Format” starting on page F-10
- “Version 2.1 DataBase Table Layout” starting on page F-11
- “Version 2.2 DataBase Table Layout” starting on page F-14

Version 1.0 UIDDataLog.Dat File Format

For version 1.0+ users who read this data into a local database, you should continue to use that format for version 1.0+ files.

The UID Mark data that is read and reported back to the UIDChecker™ user interface will be saved on the customer’s hard drive in the following format:

- HTML files containing the results for a single read. These files contain the text and image data, allowing for simple viewing in a web browser. HTML offers a more secure file structure than a typical text file. Editing or changing data results is more difficult for a novice PC user. HTML file names are the unique hex number prefixed by “Result_” and suffixed by “.html”.
- Image files are the bitmap image used for the read. Saving image data is a user-defined option. Image file names are the unique hex number prefixed by “Image_” and suffixed by “.bmp”.
- The cumulative log file gets appended with the text for each result that is saved. The log file name is “UIDDataLog.dat”. This file contains the raw text data in comma-delimited fields. Customers who wish to automate their UID Mark Reading results using perhaps a database scheme will be able to use this log file.

Each saved result places a single line of data into the cumulative log file. The data is comma delimited in the following order:

- Path and Name of Image, if image saving is enabled
Or
Result Number and “:No Image Saved”, if image saving is disabled
- Month and Day (e.g., November 4)
- Year and Time of Result (e.g., “2004 13:24:34”)
- Software Version (e.g., “1.0.0”)
- The string “UII:” followed by the decoded UID string
(e.g., “UII: UN077991289420243510936”)
Or
The string “UII: Not a valid UID Data Matrix” if the mark is invalid
- “PASS”, if UID Compliant
Or
“FAIL”, if not UID Compliant
- “FORMAT INVALID”, if raw data is not a UII format string
Or
UID Construct (e.g., “# 1”), if raw data is a UII format string
- “RAW DATA:” followed by raw data, if raw data is not a UID format string

Or

If raw data is a UII format string:

“Data Qualifier” followed by semantic code

(e.g., “Data Qualifier: Data Identifier (DI)”)

“Data Element 1:” followed by first data element

(e.g., “Data Element 1: 12V077991289”)

“Data Element 2:” followed by second data element

“Data Element 3:” followed by third data element

“Data Element 4:” followed by fourth data element

“Data Element 5:” followed by fifth data element

“Data Element 6:” followed by sixth data element

- “Overall Grade:” followed by the currently displayed overall grade value
- “Contrast Grade:” followed by the currently displayed contrast grade value
- If the “Show Verification Details” option was enabled at the time that the result was saved, the next items will be:
 - “Value = c%”, where c is the contrast percentage value
 - “Exposure = e Gain = g” where e is the exposure value and g is the gain value at the time the result was taken.
- “Print Growth Grade:” followed by the currently displayed print growth grade value
- If the “Show Verification Details” option was enabled at the time that the result was saved, the next item will be:
 - “X Y = x% y%”, where x is the print growth in X percentage value and y is the print growth in Y percentage value
- “Axial Non-Uniformity Grade” followed by the currently displayed axial uniformity grade value
- If the “Show Verification Details” option was enabled at the time that the result was saved, the next item will be:
 - “Value = a%”, where a is the axial non-uniformity percentage value
- “Unused Error Correction Grade” followed by the currently displayed unused error correction grade value

- If the “Show Verification Details” option was enabled at the time that the result was saved, the next item will be:
“Value = a%”, where a is the unused error correction percentage value
- User defined Field 1
- User defined Field 2
- User defined Field 3
- User defined Field 4
- User defined Field 5

This scheme allows Microscan to use a standard Microsoft web-browser control to display, print, and delete all records. Using this scheme, the display of each record will include both the read results as “text” and the corresponding read result image coupled together for the user to easily view.

When you start to use this new version 2.0+ software, you will have to change the read format of the data. The details of each are shown below.

Version 2.0 UIDDataLog.Dat File Format

The following information is a detailed listing of the comma-delimited contents for a version 2.0 data file. Using this description, you should be able to transfer the data into your local database.

The UID Mark data that is read and reported back to the UIDChecker™ user interface will be saved on the customer’s hard drive in the following format:

- HTML files containing the results for a single read. These files contain the text and image data, allowing for simple viewing in a web browser. HTML offers a more secure file structure than a typical text file. Editing or changing data results is more difficult for a novice PC user. HTML file names are the unique hex number prefixed by “Result_” and suffixed by “.html”.
- Image files are the bitmap image used for the read. Saving image data is a user-defined option. Image file names are the unique hex number prefixed by “Image_” and suffixed by “.bmp”.
- The cumulative log file gets appended with the text for each result that is saved. The log file name is “UIDDataLog.dat”. This file contains the raw text data in comma-delimited fields. Customers who wish to automate their

UID Mark Reading results using perhaps a database scheme will be able to use this log file.

Each saved result places a single line of data into the cumulative log file. The data is comma delimited in the following order:

- Path and Name of Image, if image saving is enabled
Or
Result Number and “:No Image Saved”, if image saving is disabled
- Month, Day, Year and Time of Result (e.g., April 20 2005 13:24:34”)
- Software Version (e.g., “2.0.0”)
- Last Calibration Date Month. Day, Year and Time
(e.g., “Calibrated Since Restart - Last: UNKNOWN” or
“Calibrated Since Restart - Last: Not Calibrated Since Restart” or
“Calibrated Since Restart - Last: April 19 2005 13:24:34”)
- The string “UII:” followed by the decoded UID string
(e.g., “UII: UN077991289420243510936”)
Or
The string “UII: Not a valid UID Data Matrix” if the mark is invalid
- “PASS”, if UID Compliant
Or
“FAIL”, if not UID Compliant
- “FORMAT INVALID”, if raw data is not a UII format string
Or
UII Construct (e.g., “# 1”), if raw data is a UII format string
- “RAW DATA:” followed by raw data, if raw data is not a UII format string
Or
If raw data is a UII format string:
“Data Qualifier” followed by semantic code
(e.g., “Data Qualifier: Data Identifier (DI)”)
“Data Element 1:” followed by first data element
(e.g., “Data Element 1: 12V077991289”)
“Data Element 2:” followed by second data element
“Data Element 3:” followed by third data element
“Data Element 4:” followed by fourth data element

Appendix F Data File Formats for UIDChecker Software

- “Data Element 5:” followed by fifth data element
- “Data Element 6:” followed by sixth data element
- The Verification Standard selected dictates the verification output reported. Use Table F–1 through Table F–5 as reference; use ONE verification standard in your data interpretation.

TABLE F–1. ISO/IEC 16022 Option

“ISO/IEC 16022”
“Overall Grade:” followed by the currently displayed overall grade value (e.g., “A” or “B” or “C” or “D” or “F”)
“Contrast Grade:” followed by the currently displayed contrast grade value (e.g., “A” or “B” or “C” or “D” or “F”) and its specific value (e.g., “Value = ##%” or “UN_Cal” or “SELF_Cal” or “REFL_Cal” or “???”)
“Axial Non-Uniformity Grade:” followed by the current grade value (e.g., “A” or “B” or “C” or “D” or “F”) and its value (e.g., “Value = #.##”)
“Print Growth Grade:” followed by the currently displayed print growth grade value (e.g., “A” or “B” or “C” or “D” or “F”) and its X and Y values (e.g., “X / Y = ##% / ##%”)
“Unused Error Correction Grade:” followed by the current unused error correction grade value (e.g., “A” or “B” or “C” or “D” or “F”) and its value (e.g., “Value = #.##”)
“Size: Height / Width =” followed by the current height and width and the units (e.g., “## / ## PIXELS” or “INCHES” or “???”)
“ECC Level:” followed by the current ECC level (e.g., “ECC200” or “ECC140” or “ECC100” or “ECC080” or “ECC050” or “ECC000” or “ECC250” or “???”)

TABLE F–2. ISO/IEC 15415 Option

“ISO/IEC 15415”
“Overall Grade:” followed by the currently displayed overall grade value (e.g., “A” or “B” or “C” or “D” or “F”)
“Contrast Grade:” followed by the currently displayed contrast grade value (e.g., “A” or “B” or “C” or “D” or “F”) and its specific value (e.g., “Value = ##%” or “UN_Cal” or “SELF_Cal” or “REFL_Cal” or “???”)
“Axial Non-Uniformity Grade:” followed by the current grade value (e.g., “A” or “B” or “C” or “D” or “F”) and its value (e.g., “Value = #.##”)
“Grid Non-Uniformity Grade:” followed by the current grade value (e.g., “A” or “B” or “C” or “D” or “F”) and its value (e.g., “Value = #.##”)

TABLE F-2. ISO/IEC 15415 Option (continued)

"ISO/IEC 15415"
"Unused Error Correction Grade:" followed by the current unused error correction grade value (e.g. "A" or "B" or "C" or "D" or "F") and its value (e.g., "Value = #.##")
"Fixed Pattern Damage Grade:" followed by the current unused error correction grade value (e.g. "A" or "B" or "C" or "D" or "F")
"Modulation Grade:" followed by the current unused error correction grade value (e.g. "A" or "B" or "C" or "D" or "F")
"Reference Decode Grade:" followed by the current unused error correction grade value (e.g. "A" or "B" or "C" or "D" or "F")
"Print Growth Grade:" followed by the currently displayed print growth grade value (e.g. "A" or "B" or "C" or "D" or "F") and its X and Y values (e.g., "X / Y = ##% / ##%")
"Cell Size:" followed by the current cell size and the units (e.g., "## / ## PIXELS" or "INCHES" or "???")
"Size: Height / Width =" followed by the current height and width and the units (e.g., "## / ## PIXELS" or "INCHES" or "???")
"ECC Level:" followed by the current ECC level (e.g., "ECC200" or "ECC140" or "ECC100" or "ECC080" or "ECC050" or "ECC000" or "ECC250" or "???")
"20x Clear Space:" followed by True or False

TABLE F-3. Dot Peen Option

"AS9132 Dot Peen"
"Module Fill:" followed by the X and Y values (e.g., "X / Y = ##% / ##%")
"Nominal Module Size:" followed by Pass or Fail (e.g., "P" or "F") and the value and units (e.g., "Value = ##" and "PIXELS" or "INCHES" or "???")
"Dot Size Offset:" followed by Pass or Fail (e.g., "P" or "F") and the value (e.g., "Value = ##")
"Dot Center Offset:" followed by Pass or Fail (e.g., "P" or "F") and the value (e.g., "Value = ##")

TABLE F-3. Dot Peen Option

“AS9132 Dot Peen”
“Angle of Distortion:” followed by Pass or Fail (e.g., “P” or “F”) and the value (e.g., “Value = ##”) degrees
“Matrix Size:” followed by Pass or Fail (e.g., “P” or “F”) and followed by COMMA (e.g., “,”) followed by “< 1.000 INCHES” or “> 1.000 INCHES”
“Size: Height / Width =” followed by the current height and width and the units (e.g., “## / ## PIXELS” or “INCHES” or “???”)
“ECC Level:” followed by the current ECC level (e.g., “ECC200” or “ECC140” or “ECC100” or “ECC080” or “ECC050” or “ECC000” or “ECC250: or “???”)

TABLE F-4. AS9132 Option

“AS9132 Electrochemical Etching”
“Module Fill:” followed by the X and Y values (e.g., “X / Y = ##% / ##%”)
“Contrast:” followed by Pass or Fail (e.g., “P” or “F”) and the contrast value (e.g., “Value = ## %”) and the qualifier (e.g., “UN_Cal” or “SELF_Cal” or “REFL_Cal” or “???”)
“Angle of Distortion:” followed by Pass or Fail (e.g., “P” or “F”) and the value (e.g., “Value = ##”) degrees
“Matrix Size:” followed by Pass or Fail (e.g., “P” or “F”) and followed by COMMA (e.g., “,”) followed by “< 1.000 INCHES” or “> 1.000 INCHES”
“Cell Size:” followed by the current cell size and the units (e.g., “## / ## PIXELS” or “INCHES” or “???”)
“Size: Height / Width =” followed by the current height and width and the units (e.g., “## / ## PIXELS” or “INCHES” or “???”)
“ECC Level:” followed by the current ECC level (e.g., “ECC200” or “ECC140” or “ECC100” or “ECC080” or “ECC050” or “ECC000” or “ECC250” or “???”)

TABLE F-5. AS9132 Laser Option

“AS9132 Laser”
“Module Fill:” followed by the X and Y values (e.g., “X / Y = ##% / ##%”)
“Contrast:” followed by Pass or Fail (e.g., “P” or “F”) and the contrast value (e.g., “Value = ##%”) and the qualifier (e.g., “UN_Cal” or “SELF_Cal” or “REFL_Cal” or “???”)
“Angle of Distortion:” followed by Pass or Fail (e.g., “P” or “F”) and the value (e.g., “Value = ##”) degrees
“Matrix Size:” followed by Pass or Fail (e.g., “P” or “F”) and followed by COMMA (e.g., “,”) followed by “< 1.000 INCHES” or “> 1.000 INCHES”
“Size: Height / Width =” followed by the current height and width and the units (e.g., “## / ## PIXELS” or “INCHES” or “???”)
“ECC Level:” followed by the current ECC level (e.g., “ECC200” or “ECC140” or “ECC100” or “ECC080” or “ECC050” or “ECC000” or “ECC250” or “???”)

- “Exposure:” and the exposure value
- “Gain:” and the gain value
- “Aperture:” and the current aperture value (e.g., AUTO or 4 or 5 or 6 or 7 or 8 or 9 or 10 or 11 or 12 or 13 or 14 or 15 or 16 or 17 or 18 or 19 or 20)
- “Call Target Contrast:” and the Contrast% (e.g., ##%)
- “Calibrated since Startup:” and the state (e.g., True or False)
- “Pixels/(0.1)inch:” and the value
- “Min/Max Raw Contrast Values:” and the values (e.g., ## / ##)
- User defined Field 1
- User defined Field 2
- User defined Field 3
- User defined Field 4
- User defined Field 5

- Customer Graphics (e.g., “Logo:” and the Path to the Customer Logo file)

Version 2.1 UIDDataLog.csv File Format

The following information is a detailed listing of the comma-delimited contents for a version 2.1 data file. Using this description, you should be able to transfer the data into your local Excel program or a database.

Due to the complexity of parsing rules for the results as presented in the comma-delimited results file, results are now provided in the same alphabetical order as in the MDB database record and each field is prefixed with a tag name in the form “<tag name>”, to make parsing easier. All fields are always written, even if empty.

Note: The “Store Results in MDB database” option must be selected to generate a comma-delimited file output as the fields in the comma-delimited file are taken from the database record. This also has the advantage of providing the value without needing to parse it from a text string.

<20xClearSpace>,FALSE,<Angle>,68,<AngleOfDistortionGrade>,,<AngleOfDistortionValue>,,<Aperture>,5,...

Recording to an MDB database may be enabled through the Results Setup dialog by selecting the Store Results in MDB database and CSV file option. This setting is saved in the registry for the user so that it is remembered the next time UIDChecker™ is started.

The first time a reading is taken after enabling the database, the dialogs displayed in Figure F–1 and Figure F–2 are displayed to provide positive feedback that the database was created and the table within the database was created.

FIGURE F–1. MDB Database Startup Sequence

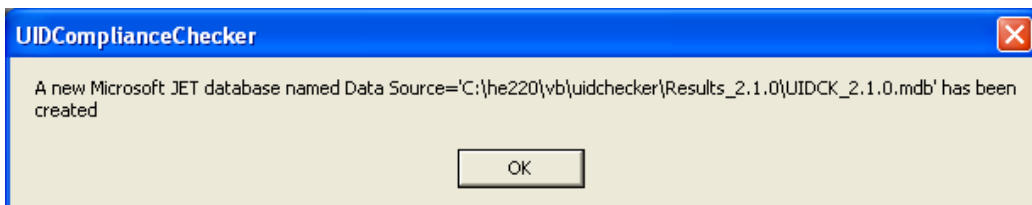
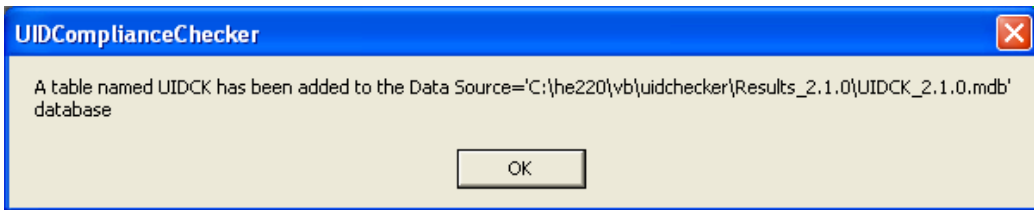

FIGURE F-2. MDB Database Startup Sequence Continued



Version 2.1 DataBase Table Layout

Note: This database is fully described in “Store Results in MDB Database and CSV File” starting on page 3-23. Please refer to this section for implementation details.

The database table layout is as follows:

TABLE F-6. Database Table Layout

Variable	Size,
20xClearSpace	VarChar(32),
Angle	int,
AngleOfDistortionGrade	VarChar(4),
AngleOfDistortionValue	int,
Aperture	VarChar(8),
AxialNonUniformityGrade	VarChar(4),
AxialNonUniformityValue	Double,
Calibrated	VarChar(64),
CalibratedSinceStartup	VarChar(64),
CalTargetContrast	int,
CellSizeError	VarChar(16),
CellSizeGrade	VarChar(4),
CellSizeValue	Double,
CellUnitReportString	VarChar(8),
Construct	VarChar(32),

TABLE F-6. Database Table Layout (continued)

Variable	Size,
ContrastGrade	VarChar(4),
ContrastReportString	VarChar(32),
ContrastValue	int,
CustomerFields1	VarChar(132),
CustomerFields2	VarChar(132),
CustomerFields3	VarChar(132),
CustomerFields4	VarChar(132),
CustomerFields5	VarChar(132),
DataElement1	VarChar(64),
DataElement2	VarChar(64),
DataElement3	VarChar(64),
DataElement4	VarChar(64),
DataElement5	VarChar(64),
DataElement6	VarChar(64),
DataQualifier	VarChar(64),
DotCenterOffsetGrade	VarChar(4),
DotCenterOffsetValue	int,
DotSizeOffsetGrade	VarChar(4),
DotSizeOffsetValue	int,
ECCLevel	VarChar(8),
Exposure	int,
FixedPatternDamageGrade	VarChar(4),
Gain	int,
GridNonUniformityGrade	VarChar(4),
GridNonUniformityValue	Double,
HTMLFileName	VarChar(255),
ImgFileName	VarChar(255),
LastUIDString	VarChar(128),
Logo	VarChar(255),
MatrixHeightValue	Double,
MatrixSizeError	VarChar(16),

TABLE F-6. Database Table Layout (continued)

Variable	Size,
MatrixSizeGrade	VarChar(4),
MatrixWidthValue	Double,
MaxRawContrastValue	int,
MinRawContrastValue	int,
ModulationGrade	VarChar(4),
ModuleFillGrade	VarChar(4),
ModuleFillXValue	int,
ModuleFillYValue	int,
NominalModuleSizeGrade	VarChar(4),
NominalModuleSizeValue	Double,
OverrideCellSize	VarChar(8),
OvalityGrade	VarChar(4),
OvalityValue	int,
OverallGrade	VarChar(4),
PixelsPerInch	int,
PrintGrowthGrade	VarChar(4),
PrintGrowthXValue	int,
PrintGrowthYValue	int,
RawData	VarChar(255),
ReaderName	VarChar(32),
ReferenceDecodeGrade	VarChar(4),
SequenceNumber	VarChar(12),
SoftwareRev	VarChar(8),
TimeofLastResult	date,
UnusedErrorCorrectionGrade	VarChar(4),
UnusedErrorCorrectionValue	Double,
ValidAndVerifPass	VarChar(8),
ValidateFailure	VarChar(128),
ValidISO15434Pass	VarChar(8),
ValidUIDPass	VarChar(8),

TABLE F-6. Database Table Layout (continued)

Variable	Size,
VerificationPass	VarChar(8),
VerificationType	VarChar(32),
VerifyFailure	VarChar(128),
VerifyReadPass	VarChar(8),

Version 2.2 DataBase Table Layout

The Version 2.2 database table layout is identical to the Version 2.3 database table layout except for the following:

TABLE F-7. Database Table Layout Differences Between V2.3 & V2.2

V2.3	V2.2
AssociatedCpnLbnString	AssociatedPartNumberString
EditUIforCpnLbn	EditUIforPartNumber
EnableCpnLbnSupport	EnablePNRSupport

Certification & Specifications

CE Compliance

The UID-LDP and UID-DPM have been certified to conform to the requirements of Council Directives 2004/108/EC, 73/23/EEC, and 93/68/EEC to comply with the following European Standards:

- EN61326:1997 A3:2003 Class A
- EN61010-1:2001-02
- EN60825-1:1993 A2 2001-01
- EM61000-6-2:2001
- EM61000-6-4:2001

This is a Class A product; in a domestic environment, this product may cause radio interference, in which case, the user may be required to make adequate measures.

All Microscan products bearing the CE mark have been declared to be in conformance with the applicable EEC Council Directives. However, certain factory installed options or customer requested modifications may compromise electromagnetic compatibility and prohibit use of the CE mark. Note that the use of interconnect cables that are not properly grounded and shielded may affect CE compliance.

FCC Statement

This equipment has been tested and found to comply with the limits for a Class A digital device, pursuant to Part 15 of the FCC Rules. These limits are designed to provide reasonable protection against harmful interference when the equipment is operated in a commercial environment. This equipment generates, uses, and can radiate radio frequency energy and, if not installed and used in accordance with the instruction manual, may cause harmful interference to radio communications. Operation of this equipment in a residential area is likely to cause harmful interference, in which case, you will be required to correct the interference at your own expense.

Changes or modifications not expressly approved by the party responsible for compliance could void your authority to operate the equipment.

FDA Statement

This equipment complies with:

US21 CFR Subchapter J Part 1040.10

IEC 60825-1:1993 Amendment 2 2001-01



Caution

The UID-LDP can be set to use targeting lasers. If the targeting lasers are activated, do not stare into the beams. The UID-LDP's targeting lasers have been rated as Class II lasers by IEC 60825-1.



Warning

DO NOT LOOK DIRECTLY AT THE BEAMS OF THE LASER!

Specifications

UID-LDP

Physical Characteristics

Dimensions:	13" L x 10" W x 11.6" H (33.0 cm L x 25.4 cm W x 29.4 cm H)
Power Requirements:	AC Adapter 100-250 VAC, 0.5A 50/60 Hz input, 24V at 500 mA output
Illumination:	Embedded Class 1 LED Red LED: 640 nm
Targeting Lasers:	Class II
Weight:	17.2 lb (7.5 kg)

Performance Characteristics

Interfaces:	Ethernet for normal operation, RS-232 baud rates 115.2 Kbps for debugging
Field of View:	1.0" x 0.75" (25.4 mm x 19 mm)
Depth of Field:	0.125" (3.175 mm)
Minimum Element Size:	0.0075" (0.19 mm)
Optical Resolution:	660 x 494 Pixels
Light Configurations:	90
Programming:	Windows 2000 / XP / Vista Business
Decode Capability:	Data Matrix, ECC200

User Environment

Operating Temperature:	32° F to 104° F (0° C to 40° C)
Storage Temperature:	122° F (50° C) Max

UID-DPM

Physical Characteristics

Dimensions:	6.7" L x 6.1" W x 8.3" H (17.0 cm L x 15.5 cm W x 21.1 cm H)
Power Requirements:	AC Adapter 100-240 VAC, 1.6A 50/60 Hz input, 24V at 1.5A output
Illumination:	Embedded Class 1 LED Red LED: 640 nm
Weight:	5.95 lb (2.7 kg)

Performance Characteristics

Interfaces:	Ethernet for normal operation, RS-232 baud rates 115.2 Kbps for debugging
Field of View:	1.19" x 0.86" (30.2 mm x 21.8 mm)
Depth of Field:	Up to 0.125" (3.175 mm)
Minimum Element Size:	0.0075" (0.19 mm)
Optical Resolution:	660 x 494 Pixels
Light Configurations:	90, D, 45Q, 30Q, 30T (North/South, East/West), 30S (North, East, South, West)
Programming:	Windows 2000 / XP / Vista Business
Decode Capability:	Data Matrix, ECC200

User Environment

Operating Temperature:	32° F to 104° F (0° C to 40° C)
Storage Temperature:	122° F (50° C) Max

Index

A

- ADO Components
 - error messages 3-25
 - fixing error E-1
- Allow Multiple Selection 3-34
- Analyzing Results 4-1
 - UID compliance check 4-1
- Apply Manual Photometry Values Button 3-17
- Archive
 - tab 3-34
 - to 3-35
- Assembling Lights D-3
- Attaching
 - camera D-2
 - lights to camera D-4
- Automatically Save the Result with Each Read 3-23

B

- Back to Summary Button 3-30
- Buttons
 - apply manual photometry values 3-17
 - back to summary 3-30
 - cancel read and rotate B-4
 - clear
 - log 3-6
 - log view 3-27
 - configure camera through serial port 3-11
 - connect via serial 3-12
 - copy 3-36

- default 3-17
- delete
 - result 3-32
 - result(s) 3-34
- learn photometry 3-17
- live video 2-7, 2-9, 3-7, B-1, B-4
- move 3-36
- next result 3-32
- normalize D-11
- previous result 3-32
- print result 3-9, 3-32, 3-34
- read 3-8
 - and rotate 3-8, 3-21, B-1, B-2
 - uid mark 3-8
- save result 3-9
- show summary results 3-32
- start search 3-34
- turn laser
 - off 3-13
 - on 3-13
- view result 3-9

C

- Calibrate 3-13, 3-15
- Calibration
 - reflectance 2-3, D-12
 - testing 2-5
- Camera
 - attaching to uid-dpm stand D-2
- Cancel Read And Rotate Button B-4
- Cell Size Restrictions
 - variance to override 3-25
- Certification G-1
- Change Results Path 3-27
- Clear
 - log button 3-6
 - log view button 3-27

Index

- Company Logo
 - specifying your 3-21
- Components 1-6
- Configurations for the multifunction light 1-16
- Configure Camera Through Serial Port
 - Button 3-11
- Configuring the Verifier D-9
- Connect via Serial Button 3-12
- Containing Text 3-34
- Control the Lighting 1-17
- Copy Button 3-36
- Customer Fields
 - defining 3-21
- D**
- Data File Formats
 - uidchecker software F-1
- Data Matrix
 - cell size 4-11
 - quality verification standard 4-11
- Database
 - mdb 3-23
 - table layout 3-24
- Default Button 3-17
- Define Customer Fields 3-21
- Delete
 - result button 3-32
 - result(s) button 3-34
- DHCP Explained 1-12
- Diffuse
 - off-axis lighting 1-16
 - perpendicular lighting 1-16
- E**
- ECC 200 4-11
- Error Messages
 - ADO components 3-25
 - validation 3-37
 - verification 3-39
- Exit 3-10
- Exposure 3-16
- F**
- F8
 - hotkey to read a mark 3-8
- File
 - menu 3-10
 - naming scheme 3-1
- Files
 - redirect output 3-27
- Find Reader Menu Item 3-10
- First Time Startup 2-1
- FOV
 - uid-dpm 1-3
 - uid-ldp 1-2
- H**
- HawkEye Sensor Lighting Normalization D-10
- I**
- Images
 - store with results 3-23
- Indicators
 - light 3-4
- Installing Long Feet Spacers 1-7
- L**
- Layout of the Database Table 3-24
- Learn Photometry Button 3-17
- Lenses
 - preparing D-3
- Lighting 1-15, 3-16
 - configurations 1-16
 - control 1-17
 - diffuse
 - off-axis 1-16
 - perpendicular 1-16
 - indicators 3-4
 - low angle
 - four direction 1-16
 - one direction 1-17
 - two direction 1-16
 - medium angle four direction 1-17
- Lights
 - assembling D-3
 - attaching to camera D-4
- Live 3-7
- Live Video Button 1-17, 2-6, 2-7, 2-9, 3-7, B-1, B-4
- Loading Software 1-9
- Long Feet Spacers
 - installing 1-7
- Look In 3-34

-
- Low Angle
 - four direction lighting 1-16
 - one direction lighting 1-17
 - two direction lighting 1-16
 - M**
 - Mark Quality
 - understanding 4-11
 - MDB
 - database 3-23
 - Measurements
 - rotational consistency of B-1
 - Medium Angle Four Direction Lighting 1-17
 - Menus
 - file 3-10
 - reader 3-10
 - Mode
 - secured 3-2
 - Move Button 3-36
 - N**
 - Network
 - setting up D-9
 - Networking to the Reader 1-10
 - New Folder Name 3-36
 - Next Result Button 3-32
 - Normalization
 - sensor lighting D-10
 - NORMALIZE Button D-11
 - O**
 - Operating Temperature 1-7
 - Operation
 - testing 2-8
 - Output Files
 - redirect 3-27
 - Overview
 - uidchecker
 - buttons 3-7
 - user interface 3-2
 - P**
 - PC
 - requirements 1-7
 - Portable Operation
 - uid-dpm 1-5
 - Positioning Data Matrix for Verification 1-17
 - Powering Up 1-9
 - Previous Result Button 3-32
 - Print Result Button 3-9, 3-32, 3-34
 - R**
 - Read
 - and rotate button 3-8, 3-21, B-1, B-2
 - when it appears 3-21
 - button 3-8
 - menu
 - turn laser off 3-13
 - uid mark button 3-8
 - Reader Menu 3-10
 - calibrate 3-13
 - find reader 3-10
 - Redirect Output Files 3-27
 - Reflectance Calibration 2-3, D-12
 - Requirements
 - pc 1-7
 - Result List Box 3-34
 - Results
 - analyzing 4-1
 - automatically save with each read 3-23
 - data file 4-6
 - path
 - changing 3-27
 - setup 3-22
 - stored in mbd database 3-23
 - view 3-28
 - Rotational Consistency of Measurements B-1
 - S**
 - Save
 - result button 3-9
 - uid read result 3-23
 - Scheme
 - file naming 3-1
 - Search Tab 3-32
 - Secured Mode 3-2
 - Setting Up
 - network D-9
 - uid-dpm stand C-1
 - Setup
 - results 3-22
 - Show
 - summary results button 3-32
-

Index

- uid details above image 3-23
- verification details in on-screen results
 - view 3-23
- Software
 - loading 1-9
 - upgrading D-9
- Specifications G-1
- Standards 3-36
- Start Search Button 3-34
- Startup 2-3
 - first time 2-1
- Static IP Explained 1-12
- Storage Temperature 1-7
- Store
 - images with results 3-23
 - results in mbd database 3-23
- Summary Report B-6
- T**
- Tabs
 - archive 3-34
 - search 3-32
 - view 3-30
- Testing
 - calibration 2-5
 - operation 2-8
 - the uid compliance verifier 2-3
- Triggers 1-18
- Turn Laser
 - off button 3-13
 - on button 3-13
- U**
- UID
 - compliance check
 - analyzing results 4-1
 - compliance verifier
 - testing 2-3
 - details
 - show above image 3-23
 - graphical display details 3-3
 - read details 3-3
 - results data file 4-6
- UIDChecker
 - buttons
 - overview 3-7
 - data file formats F-1
 - upgrading A-1
 - user interface
 - overview 3-2
- UID-DPM
 - field of view 1-3
 - portable operation 1-5
 - setting up stand C-1
- UID-LDP Field of View 1-2
- Understanding Mark Quality 4-11
- Upgrading
 - from a previous version 1-13
 - software D-9
 - uidchecker A-1
- V**
- Variance to Override Cell Size Restrictions 3-25
- Verification
 - details
 - show in on-screen results view 3-23
 - positioning data matrix 1-17
 - type 3-18
- Verifier
 - configuring D-9
- Verifier Setting
 - recommended
 - 25mm lens D-5
 - 35mm lens D-7
- View
 - result button 3-9
 - results 3-28
 - tab 3-30
- W**
- Windows
 - 2000 1-7
 - Vista Business 1-7
 - xp 1-7