

MS-820-to-QX-830 Compact Industrial Scanner Transition Guide

The purpose of this document is to assist the user in transitioning from the **MS-820** to the **QX-830**.

MS-820 scanners have been used in a wide variety of applications, including food packaging, electronics manufacturing, automotive manufacturing, and other industrial environments. With the introduction of the **QX-830 Compact Industrial Scanner** and the **QX Platform**, applications that have used the MS-820 have the opportunity to simplify their connectivity, enhance their decode performance, and increase their configuration flexibility by upgrading to the new system.

Important: The QX-830 is not a drop-in replacement for the MS-820.

The following procedure is a streamlined way of converting an application from the MS-820 to the QX-830.

1. Be sure that the version of **ESP Software** on the host computer is **ESP 5.0** or higher. ESP is available on the Microscan Tools CD and in the Download Center at www.microscan.com.
2. Connect the **MS-820** to the host computer, open **ESP**, and **Receive Reader Settings** from the MS-820.

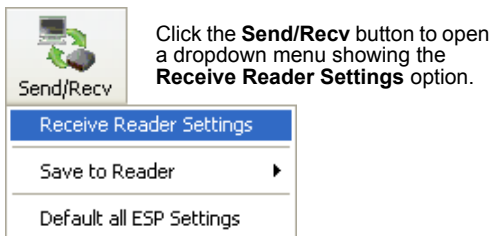

3. Navigate to the **Differences** tab in ESP's **Utilities** view and click the **Differences from Default** button. A list of commands will appear in a table below the Difference from Default button.

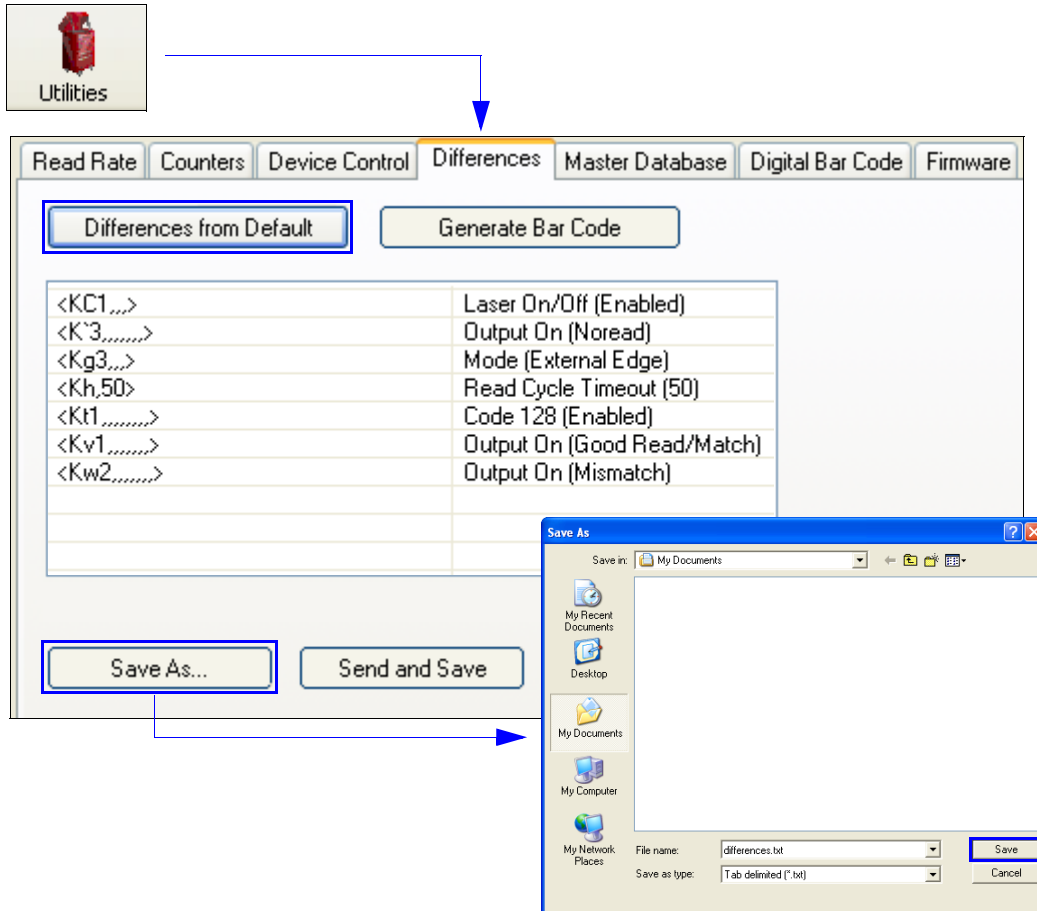

4. Click the **Save As** button below the Differences from Default command table, and select the **tab delimited (*.txt)** file type when the Windows **Save As** dialog appears. Select the preferred location for the file on the host hard drive and click **Save**.

MS-820-to-QX-830 Compact Industrial Scanner Transition Guide

- Remove power and physically disconnect the MS-820, physically connect the **QX-830**, reapply power, then **Switch Model** in ESP and select the QX-830 from the model menu.

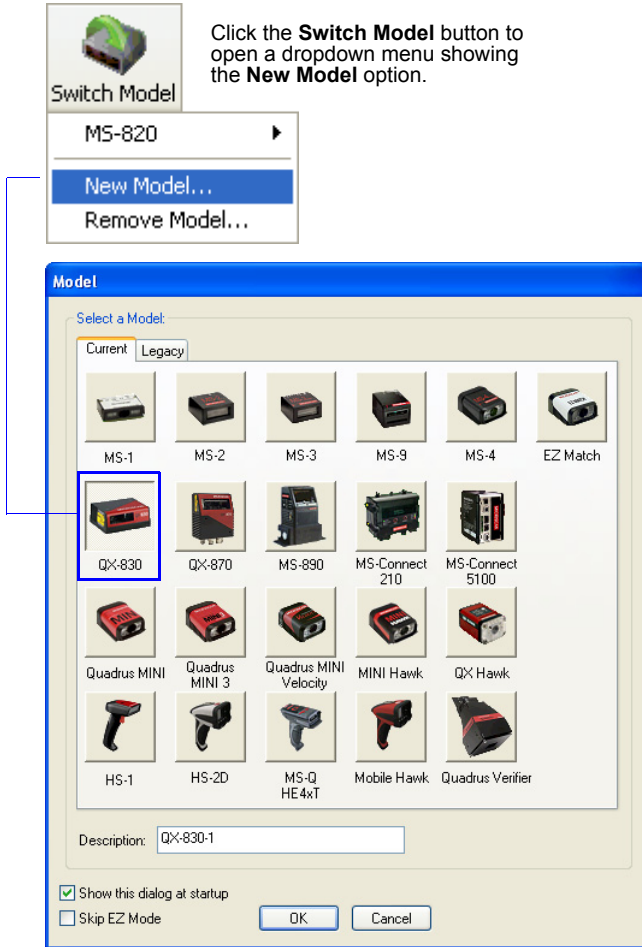

- Autoconnect to the QX-830.

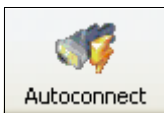

- Match the command settings in ESP's QX-830 tree controls to the list of commands in the tab delimited file that was created in Step 4. Refer to the [MS-820-to-QX-830 Command Comparisons](#) table for a list of command equivalents between the MS-820 and QX-830.

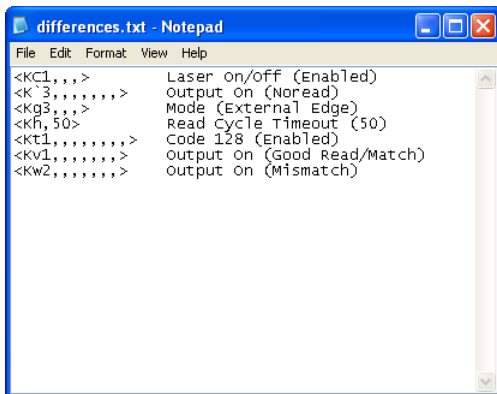

Tab Delimited Text File with MS-820 Differences from Default Settings

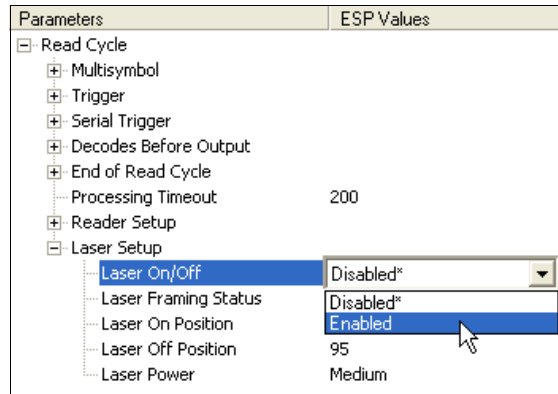

QX-830 ESP Tree Control

MS-820-to-QX-830 Compact Industrial Scanner Transition Guide

8. Once all the command settings shown in the tab delimited text file are matched in ESP's tree controls, **Send and Save** the settings to the QX-830.

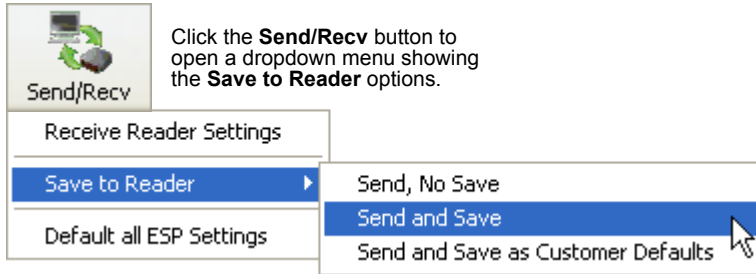

9. Make additional configuration changes to the QX-830 as required by the application. Refer to the *QX-830 Compact Industrial Scanner User's Manual* for detailed information about scanner configuration.

For further assistance with any part of the MS-820 to QX-830 conversion process, contact your Microscan Partner or the Microscan Help Desk:

helpdesk@microscan.com

+1.425.203.4841 / +1.800.251.7711

MS-820-to-QX-830 Command Comparisons

The following table shows MS-820 commands on the left and QX-830 commands on the right. The name of the command is shown first, and the parameters are shown to the right of the name.

Commands that have remained equivalent or near-equivalent from MS-820 to QX-830 are shown directly opposite each other. Some MS-820 commands are not present in the QX-830, and some QX-830 commands are new. This is indicated with gray boxes.

MS-820 Commands		QX-830 Commands	
MS-820 Communications		QX-830 Communications	
Host Port Connections	<K a baud rate,parity,stop bits,data bits>	RS-232 A	<K 100 ,baud rate,parity,stop bits,data bits>
Host Protocol	<K f protocol>		
RS-422 Status	<K b status>		
Auxiliary Port	<K y aux port mode,baud rate,parity,stop bits,data bits,daisy chain status,daisy chain ID>	RS-232 B	<K 101 ,status,baud rate,parity,stop bits,data bits>
		RS-422	<K 102 ,status,baud rate,parity,stop bits,data bits>
		Ethernet	<K 126 ,status,IP address,subnet,gateway,IP address mode>
		Ethernet TCP Ports	<K 127 ,TCP Port 1,TCP Port 2>
		EtherNet/IP	<K 129 ,status>
		RS-232 A Data Type	<K 130 ,symbol data output,extra symbol information,diagnostic output, external source processing mode>
		RS-232 B Data Type	<K 131 ,symbol data output,extra symbol information,diagnostic output, external source processing mode>
		RS-422 Data Type	<K 132 ,symbol data output,extra symbol information,diagnostic output, external source processing mode>
		Ethernet TCP Port 1 Data Type	<K 133 ,symbol data output,extra symbol information,diagnostic output, external source processing mode>
		Ethernet TCP Port 2 Data Type	<K 134 ,symbol data output,extra symbol information,diagnostic output, external source processing mode>
		EtherNet/IP Data Type	<K 136 ,symbol data output,extra symbol information,diagnostic output, external source processing mode>
Preamble	<K d status,preamble>	Preamble	<K 141 ,status,preamble>
Postamble	<K e status,postamble>	Postamble	<K 142 ,status,postamble>
Response Timeout	<K A response timeout>	Response Timeout	<K 143 ,response timeout>
LRC Status	<K c status>	LRC Status	<K 145 ,status>
		ACK/NAK Options	<K 147 ,RES,REQ,STX,ETX,ACK,NAK>
		Polling Mode Options	<K 148 ,RES,REQ,STX,ETX,ACK,NAK>
		Autoconfiguration Daisy Chain	<K 150 DAISY>
		Protocol Selection	<K 160 ,protocol,address,protocol port>
		External Data Routing	<K 161 ,mode,destination port,ambles to source,echo to source,output at end of read cycle,output at ETX,output at Timeout>
		Array Communication Modes	<K 162 ,mode,source,daisy chain i.d. status,daisy chain i.d.>
Intercharacter Delay	<K B intercharacter delay>		

MS-820-to-QX-830 Compact Industrial Scanner Transition Guide

MS-820 Commands		QX-830 Commands	
		QX-830 Calibration	
		Auto Calibration Menu	<@>
		Auto Calibration without Menu	<@CAL>
MS-820 Read Cycle		QX-830 Read Cycle	
Trigger Mode	<Kgtrigger mode,filter time>	Trigger Mode / Trigger Filter Duration	<K200,trigger mode,leading edge trigger filter duration,trailing edge trigger filter duration>
Serial Trigger Character	<Kiserial trigger character>	Serial Trigger Character	<K201,serial trigger character>
External Trigger State	<Kjexternal trigger state>	External Trigger State	<K202,external trigger state>
End of Read Cycle	<Khmode,read cycle timeout>	End of Read Cycle	<K220,mode,read cycle timeout>
Good Decode Reads	<Kmgood decode reads>	Decodes Before Output	<K221,mode,number before output>
Multisymbol	<KLnumber of symbols,multisymbol separator>	Multisymbol	<K222,number of symbols, multisymbol separator>
		Serial Trigger Start Character	<K229,start character>
		Serial Trigger Stop Character	<K230,stop character>
		Processing Timeout	<K245,processing timeout>
Motor On	<KE>	Scan Speed	<K500,scan speed>
Motor Off	<KF>	Motor Off	<K501,motor off>
Maximum Element	<KImaximum element>	Maximum Element	<K502,maximum element>
Automatic Gain Control	<KDAGC sampling mode,AGC min, AGC max>	Automatic Gain Control	<K504,gain level,AGC sampling mode,AGC minimum,AGC maximum>
Symbol Detect Status / Transition Counter	<KHsymbol detect status,transition counter>	Symbol Detect Status / Transition Counter	<K505,symbol detect status, transition counter>
		Scan Width Enhance	<K511,status>
		AGC Tracking	<K520,tracking>
Scanner Type	<KPdensity>		
Laser Controls	<KClaser on/off,laser framing status,laser on position,laser off position>	Laser Setup	<K700,laser on/off,laser framing status,laser on position,laser off position,laser power>
		QX-830 Configuration Database	
		Number of Active Indexes	<K252,number of active indexes, number of database cycles>
		Configuration Database	<K253,index,gain,AGC mode, tracking, unused 1,unused 2, unused 3,framing status,laser on position,laser off position,laser power,background color>
		Switch Timing	<K254,switch mode,time>
MS-820 Symbolologies		QX-830 Symbolologies	
Narrow Margins / Symbology Identifier	<Konarrow margins,symbology identifier status>	Quiet Zone	<K450,quiet zone status>
Background Color	<Kxbackground color>	Background Color	<K451,background color>
		Composite	<K453,symbology status,separator status,separator>
AIAG	<KZstatus,ID1,status1,ID2, status2,ID3,status3,ID4,status4, ID5a,ID5b,ID5c,status5,ID6, status6,ID7,status7,ID8,status8, ID9, status9,ID10,status10,ID11, status11, ID12,status12>	AIAG	<K454,status,ID1,status1, ID2,status2,ID3,status3,ID4, status4,ID5a,ID5b,ID5c,status5, ID6,status6,ID7,status7,ID8, status8,ID9,status9,ID10,status10, ID11,status11,ID12,status12>
		Depth of Field Enhance	<K456,DOF Enhance mode>

MS-820-to-QX-830 Compact Industrial Scanner Transition Guide

MS-820 Commands		QX-830 Commands	
MS-820 Symbolologies (continued)		QX-830 Symbolologies (continued)	
Code 39	<Kpstatus,check digit status,check digit output status,large intercharacter gap,fixed symbol length status,fixed symbol length,full ASCII set>	Code 39	<K470,status,check character status,check character output status,large intercharacter gap,fixed symbol length status,fixed symbol length,full ASCII set>
Codabar	<Kqstatus,start and stop match status,start and stop output status,large intercharacter gap,fixed symbol length status,symbol length,check digit type,check digit output>	Codabar	<K471,status,start/stop match status,start/stop output status,large intercharacter gap,fixed symbol length status,fixed symbol length,check character type,check character output status>
Interleaved 2 of 5	<Krstatus,check digit status,check digit output,symbol length 1,symbol length 2>	Interleaved 2 of 5	<K472,status,check character status,check character output status,symbol length 1,symbol length 2,guard bar,range mode status>
UPC/EAN	<KsUPCstatus,EAN status,supplementals status,separator status,separator character>	UPC/EAN	<K473,mode,EAN status,supplementals status,separator status,separator character,supplementals type,UPC-E as UPC-A>
Code 128 / EAN 128	<Ktstatus,fixed symbol length status,fixed symbol length,EAN-128 status,output format,application record separator status,application record separator character,application record brackets,application record padding>	Code 128 / EAN 128	<K474,status,fixed symbol length status,fixed symbol length,EAN status,output format,application record separator status,application record separator character,application record brackets,application record padding,separation factor>
Code 93	<Klstatus,fixed symbol length status,symbol length>	Code 93	<K475,mode,fixed symbol length status,symbol length>
PDF417	<Klstatus,raster sweeps before decode attempt,fixed length status,symbol length>	PDF417	<K476,status,scan line limit,fixed symbol length status,fixed symbol length,decode at end of read cycle>
		Pharmacode	<K477,status,fixed bar count status,fixed bar count,minimum bar count,bar width mode,direction,fixed threshold value>
		DataBar Omnidirectional (RSS-14)	<K482,status>
		DataBar Limited (RSS Limited)	<K483,status>
		DataBar Expanded (RSS Expanded)	<K484,status,fixed symbol length status,fixed symbol length>
		MicroPDF417	<K485,status,scan line limit,fixed symbol length status,fixed symbol length>
		Symbol Reconstruction	<K496,symbol reconstruction redundancy,symbol reconstruction effort>
MS-820 I/O Parameters		QX-830 I/O Parameters	
		Calibration Options	<K521,unused,video,scan speed,laser power,laser framing,symbology>
Serial Verification	<KScommand echo status,command beep status,control/hex output>	Serial Verification	<K701,serial command echo status,serial command beep status,control/hex output>
Beeper	<Kustatus,volume>	Beeper	<K702,status>
Quality Output	<KJquality output separator,decodes/trigger status,decode direction output>	Quality Output	<K704,quality output separator,decodes/trigger status,decode direction output>
Symbol Data Output	<Klstatus,symbol data output status,when to output>	Symbol Data Output	<K705,symbol data output status,when to output symbol data,symbology identifier status>
		Read Duration Output	<K706,status,separator>

MS-820-to-QX-830 Compact Industrial Scanner Transition Guide

MS-820 Commands		QX-830 Commands	
MS-820 I/O Parameters (continued)		QX-830 I/O Parameters (continued)	
No Read Message	<Kkstatus,message>	No Read Message	<K714,status,message>
Bad Symbol Message	<K'status,message>	Bad Symbol Message	<K715,status,message>
No Symbol Message	<KNstatus,message>	No Symbol Message	<K716,status,message>
		Input 1	<K730,input mode,active state>
No Object Message	<KOstatus,message>		
Laser On / Off Status	<KClaser on/off status>		
Partial Output	<KYstatus,start postion,length>		
		Green Flash LED	<K750,green flash mode,unused,green flash duration>
		Status Indicators	<K751,status,bar graph,I/O 1,I/O 2>
		Symbol Position Output	<K758,scan status,separator>
		Database Identifier Output	<K759,status,separator character>
		EZ Button	<K770,status,default on power-on>
		EZ Button Modes	<K771,single beep,two beeps,three beeps,four beeps>
		Auto Framing Options	<K773,laser framing>
Output 1	<Kvoutput on,active state,pulse width,output mode,trend analysis mode,trigger evaluation period,number to output on,reads per trigger threshold>		
Output 2	<Kwoutput on,active state,pulse width,output mode,trend analysis mode,trigger evaluation period,number to output on,reads per trigger threshold>		
Output 3	<K'output on,active state,pulse width,output mode,trend analysis mode,trigger evaluation period,number to output on,reads per trigger threshold>		
		Trend Analysis Output 1	<K780,trend analysis mode,number of triggers,number to output on,decodes per trigger>
		Trend Analysis Output 2	<K781,trend analysis mode,number of triggers,number to output on,decodes per trigger>
		Trend Analysis Output 3	<K782,trend analysis mode,number of triggers,number to output on,decodes per trigger>
		Diagnostics Output 1	<K790,high temperature,service unit,unused,laser current high,laser current low,low temperature>
		Diagnostics Output 2	<K791,high temperature,service unit,unused,laser current high,laser current low,low temperature>
		Diagnostics Output 3	<K792,high temperature,service unit,unused,laser current high,laser current low,low temperature>
		Output 1 Parameters	<K810,output on,output state,pulse width,output mode>
		Output 2 Parameters	<K811,output on,output state,pulse width,output mode>
		Output 3 Parameters	<K812,output on,output state,pulse width,output mode>

MS-820-to-QX-830 Compact Industrial Scanner Transition Guide

MS-820 Commands		QX-830 Commands	
MS-820 Matchcode		QX-830 Matchcode	
Matchcode	<K n matchcode type, sequential matching, match start position, match length, wildcard character, sequence on noread, sequence on mismatch>	Matchcode	<K223, matchcode type, sequential matching, match start position, match length, wildcard, sequence on no read, sequence on mismatch>
Master Symbol Database Size	<KMnumber of master symbols>	Master Symbol Database Size	<K224, number of master symbols>
New Master Pin	<Kzstatus>	New Master Pin	<K225, status>
		Sequence Step	<K228, sequence step>
		Master Symbol	<K231, index, master symbol data>
		Match Replace	<K735, status, replacement string>
		Mismatch Replace	<K736, status, replacement string>
MS-820 Diagnostics		QX-830 Diagnostics	
High Temperature Threshold	<K+degrees, message>	High Temperature Threshold	<K402, status, message>
Low Temperature Threshold	<K-degrees, message>	Low Temperature Threshold	<K403, status, message>
Counts (Read-only)	<K_?> (returns: power-ons, resets)	Counts (Read-only)	<K406> (returns: power-on, resets, power-on saves, custom default saves)
Hours Since Reset (Read-only)	<K@?> (returns: hours, minutes)	Hours Since Reset (Read-only)	<K407> (returns: hours, minutes)
Warning Message Status	<K" warning message status, laser high status, laser low status, NOVRAM corrupt warning status>		
		Service Message	<K409, status, service message, threshold, resolution>
Laser High Warning	<K;laser high message>		
Laser Low Warning	<K:laser low message>		
		Laser Current Warning Message	<K411, laser high status, laser high message, laser low status, laser low message>
Present Operating Temperature	<K%?> (returns: degrees Celsius)		
Lifetime Hours	<K\$hours10, message>		
		User-Defined Name	<K412, user-defined name>
		QX-830 Output Format	
		Format Extract	<K740, output index, start location, length>
		Format Insert	<K741, output index, length, hex string>
		Format Assign	<K742, symbol number, status>
		Format Status	<K743, output format status>
		Output Filter Configuration	<K744, filter number, symbology, length, wildcard, placeholder, data, unused, database index>
		Output Filter Enable	<K745, number of filters>

MS-820 Alpha Commands Supported in the QX-830

The following table shows MS-820 alpha commands that will function in the QX-830. The QX-830 is intended for use with numeric commands, but the commands shown below can be used in the QX-830.

Important: Microscan does not guarantee support for these commands in future versions of the QX-830.

Alpha Commands		Numeric
Communications		
Host Port Connections	<K a baud rate,parity,stop bits,data bits>	<K 100 >
Auxiliary Port	<K y aux port mode,baud rate,parity,stop bits,data bits,daisy chain status,daisy chain ID>	<K 101 >
Preamble	<K d status,preamble>	<K 141 >
Postamble	<K e status,postamble>	<K 142 >
Response Timeout	<K A response timeout>	<K 143 >
LRC Status	<K c status>	<K 145 >
Read Cycle		
Trigger Mode	<K g trigger mode,filter time>	<K 200 >
Serial Trigger Character	<K i serial trigger character>	<K 201 >
External Trigger State	<K j external trigger state>	<K 202 >
End of Read Cycle	<K h mode,read cycle timeout>	<K 220 >
Good Decode Reads	<K m good decode reads>	<K 221 >
Multisymbol	<K L number of symbols,multisymbol separator>	<K 222 >
Motor On/Scan Speed	<K E >	<K 500 >
Motor Off	<K F >	<K 501 >
Maximum Element	<K I maximum element>>	<K 502 >
Laser Controls	<K C laser on/off,laser framing status,laser on position,laser off position>	<K 700 >
Symbologies		
Narrow Margins / Symbology Identifier	<K o narrow margins,symbology identifier status>	<K 450 >
Background Color	<K x background color>	<K 451 >
AIAG	<K Z status,ID1,status1,ID2,status2,ID3,status3,ID4,status4,ID5a,ID5b,ID5c,status5,ID6,status6,ID7,status7,ID8,status8,ID9,status9,ID10,status10,ID11,status11,ID12,status12>	<K 454 >
Code 39	<K p status,check digit status,check digit output status,large intercharacter gap,fixed symbol length status,fixed symbol length,full ASCII set>	<K 470 >
Codabar	<K q status,start and stop match status,start and stop output status,large intercharacter gap,fixed symbol length status,symbol length,check digit type,check digit output>	<K 471 >
Interleaved 2 of 5	<K r status,check digit status,check digit output,symbol length 1,symbol length 2>	<K 472 >
UPC/EAN	<K s UPCstatus,EAN status,supplementals status,separator status,separator character>	<K 473 >
Code 128 / EAN 128	<K t status,fixed symbol length status,fixed symbol length,EAN-128 status,output format,application record separator status,application record separator character,application record brackets,application record padding>	<K 474 >
Code 93	<K l status,fixed symbol length status,symbol length>	<K 475 >
PDF417	<K j status,raster sweeps before decode attempt,fixed length status,symbol length>	<K 476 >
I/O Parameters		
Serial Verification	<K S command echo status,command beep status,control/hex output>	<K 701 >
Beeper	<K u status,volume>	<K 702 >
Quality Output	<K J quality output separator,decodes/trigger status,decode direction output>>	<K 704 >
Symbol Data Output	<K I symbol data output status,when to output>	<K 705 >
No Read Message	<K k status,message>	<K 714 >
Bad Symbol Message	<K ' status,message>	<K 715 >
No Symbol Message	<K N status,message>	<K 716 >

MS-820-to-QX-830 Compact Industrial Scanner Transition Guide

Alpha Commands		Numeric
Matchcode		
Matchcode	<K n matchcode type, sequential matching, match start position, match length, wildcard character, sequence on noread, sequence on mismatch>	<K223>
Master Symbol Database Size	<K M number of master symbols>	<K224>
New Master Pin	<K z status>	<K225>
Diagnostics		
High Temperature Threshold	<K+degrees, message>	<K402>
Low Temperature Threshold	<K-degrees, message>	<K403>
Counts (Read-only)	<K_?> (returns: power-ons, resets)	<K406>
Hours Since Reset (Read-only)	<K@?> (returns: hours, minutes)	<K407>

MS-820 and QX-830 Connectivity

There are significant hardware and connectivity differences between the MS-820 and QX-830. The diagrams and parts list below demonstrate the difference between MS-820 and QX-830 hardware configuration.

Note: For other configurations, such as multidrop and daisy chain, refer to the configuration guides and user's manuals for the MS-820 and QX-830.

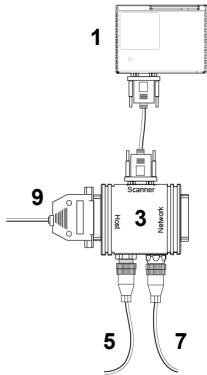

MS-820 Standalone with IB-131

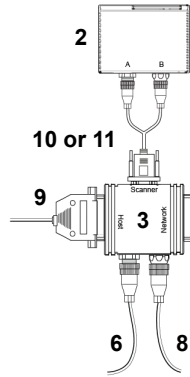

QX-830 Serial Standalone with IB-131

A QX-830 can be connected to an IB-131 Interface Box using the RS-232 M12 to 15-pin Dsub cordset (10) or the RS-422/485 M12 to 15-pin Dsub cordset (11). The RS-232 cordset (10) is for RS-232 and AUX. The RS-422/485 cordset (11) does not support RS-232, regardless of individual scanner command settings.

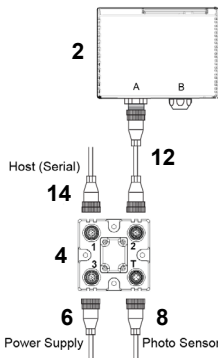

QX-830 Serial Standalone with QX-1

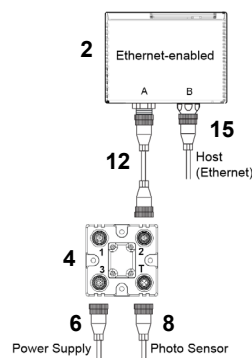

QX-830 Ethernet Standalone with QX-1

Item	Description	Part Number
1	MS-820 Industrial Laser Scanner	FIS-0820-XXXXG
2	QX-830 Compact Industrial Scanner	FIS-0830-XXXXG
3	IB-131 Kit, Interface Box and IB-131 cable, 6 ft.	98-000014-02
4	QX-1 Interface Device	98-000103-02
5	Power Supply, 90-264 VAC, 24VDC, USA/Euro plug	97-100004-15
6	QX Power Supply, M12 12-pin Socket, 1.3 m	97-000003-01
7	Object Detector Photo Sensor, Visible, NPN, Dark On	99-000017-01
8	QX Photo Sensor, M12 4-pin Plug, NPN, Dark On, 2 m	99-000020-02
9	Communication Cable, 25-pin plug to 9-pin socket, 6 ft.	61-300026-03
10	QX Cordset, M12 12-pin plug and M12 12-pin socket to IB-131, RS-232, 2 m	61-000159-03
11	QX Cordset, M12 12-pin plug and M12 12-pin socket to IB-131, RS-422/485, 2 m	61-000159-04
12	QX Cordset, Common, M12 12-pin Plug to M12 12-pin Socket, 1 m	61-000162-01
13	QX Cordset, Host, Serial, M12 12-pin Plug to DB9, 1 m (not shown)	61-000152-01
14	QX Cordset, Host, Serial, M12 12-pin Socket to DB9, 1 m	61-000153-01
15	QX Cordset, Host, Ethernet, M12 8-pin Plug to RJ45, 1 m	61-000160-01
16	QX Cordset, M12 12-pin Plug to MS-Connect 5100, 3 m (not shown)	61-000161-01
17	QX Cordset, M12 12-pin Plug/M12 12-pin Socket to MS-Connect 210, RS-232, 2 m (not shown)	61-000158-03
18	QX Cordset, M12 12-pin Plug/M12 12-pin Socket to MS-Connect 210, RS-422/485, 2 m (not shown)	61-000158-04

MS-820 and QX-830 Specifications

Mechanical

The mounting dimensions of the MS-820 and QX-830 are essentially the same, although the M12 receptacles at the back of the QX-830 may affect installation in some applications.

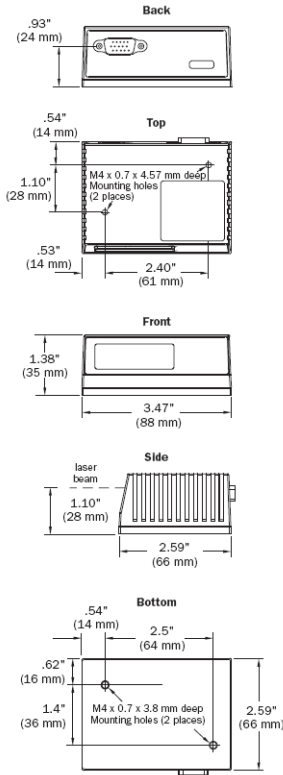

MS-820 Dimensions

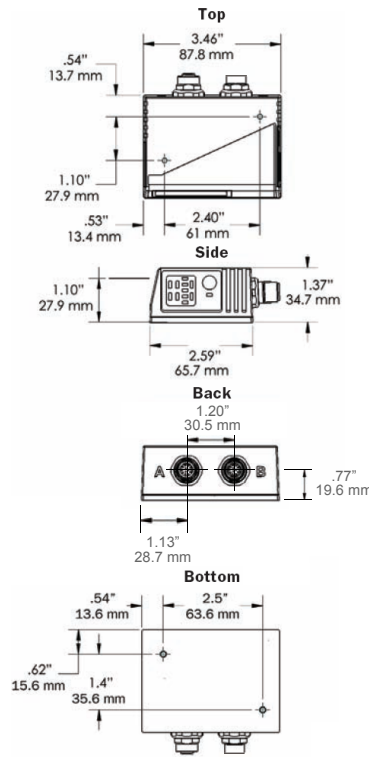

QX-830 Dimensions

Environmental

MS-820		QX-830	
Enclosure	Die-cast aluminum, IP54 rated	Enclosure	Die-cast aluminum, IP65 rated
Operating Temperature	0° to 50° C (32° to 122° F)	Operating Temperature	0° to 50° C (32° to 122° F)
Storage Temperature	-50° to 75° C (-58° to 167° F)	Storage Temperature	-50° to 75° C (-58° to 167° F)
Humidity	Up to 90% (non-condensing)	Humidity	Up to 90% (non-condensing)

Emissions

MS-820		QX-830	
Heavy industrial	EN 61000-6:1999	Heavy industrial	EN 61000-6-2:2005
Radiated emissions	EN 55022:1998 Class A 30-1000 MHz	Radiated emissions	EN 55022:2006 Class A 30-1000 MHz
Conducted emissions	EN 55022:1998 Class A .15-30 MHz	Conducted emissions	EN 55022:2006 Class A .15-30 MHz

Laser Light

MS-820		QX-830	
Output Wavelength	650 nm nominal (MS-825 infrared option: 780 nm nominal)	Output Wavelength	655 nm nominal
Safety Class	Visible laser: CDRH Class II, 650 nm; Infrared Laser: CDRH Class I, 780 nm	Safety Class	Visible laser: CDRH Class II, 655 nm

Scanning Parameters

MS-820		QX-830	
Scan Rate	Adjustable from 350 to 1100 scans per second	Scan Rate	Adjustable from 300 to 1400 scans per second
Symbol Contrast	25% min. absolute dark to light differential at 650 nm wavelength.	Symbol Contrast	25% min. absolute dark to light differential at 655 nm wavelength.

Communication Interface

Note: Ports in the MS-820 are duplexed, whereas each of the QX-830's ports are dedicated.

MS-820		QX-830	
Interfaces	RS-232, RS-422, RS-485	Interfaces	RS-232, RS-422, RS-485, Ethernet

Protocols

MS-820		QX-830	
Protocols	Point-to-Point, Point-to-Point with RTS/CTS, Point-to-Point with XON/XOFF, Point-to-Point with RTS/CTS and XON/XOFF, Polling Mode D, Multidrop, Daisy Chain, User-Defined, User-Defined Multidrop	Protocols	Point-to-Point, Point-to-Point with RTS/CTS, Point-to-Point with XON/XOFF, Point-to-Point with RTS/CTS and XON/XOFF, Multidrop, Daisy Chain, User-Defined Multidrop, Ethernet TCP/IP, EtherNet/IP

Symbologies

MS-820		QX-830	
Symbologies	Standard Offering: Code 39, Codabar, Code 93, Interleaved 2 of 5, Code 128, PDF417, Pharmacode (optional). Applications Standards: EAN-128, AIAG	Symbologies	Standard Offering: Code 39, Codabar, Code 93, Interleaved 2 of 5, Code 128, PDF417, MicroPDF417, Pharmacode, UPC, GS1 DataBar. Applications Standards: EAN-128, AIAG

Electrical

MS-820		QX-830	
Power Requirement	10-28VDC, 200 mV p-p max. ripple, 120mA at 24VDC (typ.)	Power Requirement	10-28VDC, 200 mV p-p max. ripple, 180mA at 24VDC (typ.)

MS-820 Pin Assignments

Pin No.	Host RS-232	Host/Aux. RS-232	Host RS-422/485	In/Out
1	Power +10 to 28VDC			In
2	TxD	TxD	TxD (-)	Out
3	RxD	RxD	RxD (-)	In
4	Power/Signal Ground			
5	Trigger (-)			In
6	RTS	Aux TxD	TxD (+)	Out
7	Output 1 (+)			Out
8	Default Configuration (Connect Pin 8 to Ground Pin 4)			In
9	Trigger (+)			In
10	CTS	Aux RxD	RxD (+)	In
11	Output 3 (+)			Out
12	New Master (+)			In
13	Chassis Ground (Used to connect chassis body to earth Ground only. Not to be used as power or signal return.)			
14	Output 2 (+)			Out
15	Outputs 1, 2, 3 (-)			Out

MS-820-to-QX-830 Compact Industrial Scanner Transition Guide

QX-830 Pin Assignments

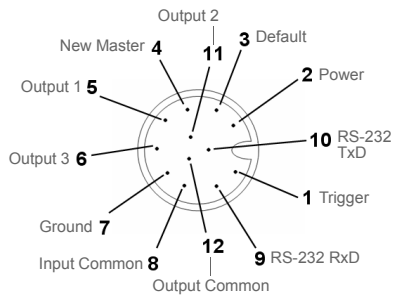

**Connector A (Serial)
M12 12-pin Plug**

1	Trigger
2	Power
3	Default
4	New Master
5	Output 1
6	Output 3
7	Ground
8	Input Common
9	RS-232 (Host) RxD
10	RS-232 (Host) TxD
11	Output 2
12	Output Common

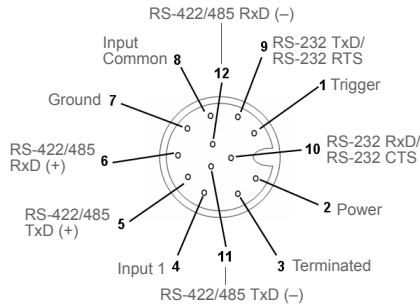

**Connector B (Serial)
M12 12-pin Socket**

1	Trigger
2	Power
3	Terminated
4	Input 1
5	Port 3 422/485 TxD (+)
6	Port 3 422/485 RxD (+)
7	Ground
8	Input Common
9	Port 2 TxD/Port 1 RTS
10	Port 2 RxD/Port 1 CTS
11	Port 3 422/485 TxD (-)
12	Port 3 422/485 RxD (-)

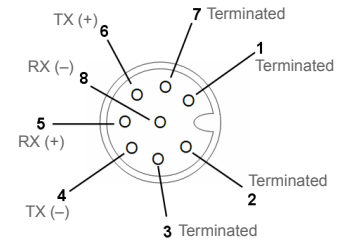

**Connector B (Ethernet)
M12 8-pin Socket**

1	Terminated
2	Terminated
3	Terminated
4	Port 4 TX (-)
5	Port 4 RX (+)
6	Port 4 TX (+)
7	Terminated
8	Port 4 RX (-)

Discrete I/O

MS-820		QX-830	
Trigger Input	Optoisolated, 4.5–28V rated (12 mA at 24VDC)	Trigger / New Master / Input 1	Optoisolated, bi-directional, 4.5–28V rated (13 mA at 24VDC)
New Master Input	Optoisolated, 4.5–28V rated (12 mA at 24VDC), New Master (-) to signal ground	Output 1 / 2 / 3	Optoisolated, bi-directional, 28V, 100mA rated (current limited by user)

Safety Certifications

MS-820		QX-830	
Certifications	CDRH, FCC, UL/cUL, CE, BSMI	Certifications	CDRH, FCC, UL/cUL, CE, CB, BSMI